

stylex

Yoom

PRICE LIST
January 15, 2024

General Information

STYLEX PRICE LIST

GENERAL INFORMATION

Terms

Net 30 days from date of invoice,
F. O. B . Delanco, New Jersey.

Damaged Shipments

All Stylex products are carefully inspected before they are packed in sturdy cartons designed to satisfy shipping requirements. Stylex is not responsible for damage in shipment. The transportation company assumes responsibility for delivering products to you in good condition when the bill of lading is signed. You protect yourself by refusing shipments showing damage or shortage until transportation company has noted on the delivery sheet the extent of damage or shortage. Concealed damage should be reported to the carrier as soon as discovered, but no later than 5 days after receiving shipment.

Return/Restocking Policy

Return shipments will not be accepted unless specifically authorized by Stylex in writing. The Return Authorization number should be clearly marked on the carton. The customer returning Stylex products is responsible for return shipping costs. Merchandise must be returned unused. Returned merchandise is subject to a 35% restocking fee.

Custom Products

Modifications to standard products will be considered for large runs. Contact factory for price quotations.

Design Changes

In keeping with modern manufacturing advances, Stylex reserves the right to incorporate minor modifications and design changes in products without notice.

Cancellation/Change Order Policy

Regarding requests for order cancellation and/or order modification, please be advised that no charges will be applied before production, unless inventory has been specifically requisitioned to fulfill your order. Once orders proceed to the production phase, they cannot be altered or canceled under any circumstances. All requests for order cancellations or order changes must be submitted in writing and will only be considered valid upon approval by Stylex.

WARRANTY

Except as provided below, Stylex warrants exclusively to the original Purchaser of our product that all parts, under normal use and service, will be free from defects in workmanship and material for a period of ten (10) years from the date of purchase. "Normal use and service" means that the product will be used in a typical office environment for 40-45 hours per week.

This warranty is subject to the following limitations, exclusions and provisions:

Limitations involving materials and components:

Wood components of plywood stacking chairs
(such as Brooks and Welcome)
5 years

Upholstery

(including mesh used for Click, F4, Insight, and Zephyr Mesh)
3 years

SAVA Mesh

10 years

COM Upholstery

No warranty
Stylex makes every effort to ensure that the COM Upholstery it approves is suitable for the intended use. Nevertheless, we will not warrant, and assume no responsibility for, the durability or tailoring quality of any COM or COL. If you have any concerns about the ultimate appearance of any covering, please order an upholstered sample.

Painted Stack Chair Frames

No Warranty

We will not warrant the finish of painted stack chair frames against damage from stacking. Please order chrome frames for chairs that will be stacked.

Felt Glides

No warranty

Due to the different surfaces on which felt glides may be used, we cannot warrant their durability over time.

If this product fails during normal use and service within the applicable warranty period (other than through normal wear and tear), please send a description of the relevant part and the nature of the defect, together with proof of purchase of the product to qm@stylexdesign.com. PLEASE DO NOT RETURN PARTS OR THE PRODUCT TO STYLEX UNLESS INSTRUCTED TO DO SO BY STYLEX. Stylex will, at its discretion, either repair or replace the defective product or part at no cost. Labor requests must receive approval and will be authorized on a case-by-case basis. We will only reimburse for labor costs directly incurred, excluding any travel-related expenses. Purchaser may be required (at the option of Stylex) to return to Stylex at Purchaser's expense any defective part with all freight or shipping charges prepaid. The foregoing warranty shall be void if the product has been altered or repaired (other than by Stylex). The warranty does not cover damage to the product caused by accident, neglect, misuse, abuse, modification to the product by anyone other than Stylex or damage caused by use of the product for a purpose other than that for which it was designed. This warranty extends only to the original Purchaser of the product.

No Other Warranties

This warranty is in lieu of all other warranties, expressed or implied, including, but not limited to, implied warranties of merchantability and fitness for a particular purpose. The rights and remedies provided herein are the exclusive rights and remedies of the original purchaser of the product.

No Liability For Damages

In no event shall Stylex or its suppliers be responsible or liable for any special, indirect, consequential, or incidental damages. In no event shall the liability of Stylex exceed the actual purchase price paid to Stylex for the product.

Out of Warranty Products

For all products no longer covered by our warranty, please refer to our Design for Durability and Upgradability Policy. Contact Customer Service if you would like to purchase any replaceable components to further extend the life of any Stylex seating product. This warranty applies to all Stylex products purchased on April 13, 2018, and thereafter.

PRODUCT TAKE BACK PROGRAM

In order to be good stewards of our products, Stylex offers a pathway towards a Product Take Back Program as a more viable solution to the end of our products' originally intended life.

Stylex supports the sustainable programs of ANEW and offers their added value to our clients through a comprehensive take-back solution for surplus office furniture and materials of any kind, in any condition. ANEW is a 501(c)(3) non-profit organization that exists to provide companies with smart, cost effective alternatives for their surplus furniture and other items with the priority of matching it to non-profits, public agencies and the underserved, within the local community of the project site. Corporate Social Responsibility is raised while the impact on the environment is lowered by diverting products and materials otherwise destined for landfill.

Stylex is proud to offer ANEW to customers dedicated to strengthening their community network by repurposing their furniture, fixtures and architectural materials to those in need. In 2014, Stylex committed to making this relationship a part of our strategic sales strategy. Visit www.anewfound.org to find out more.

To initiate a Product Take Back strategy through ANEW, contact Stylex Customer Service at 800-257-5742.

For other end of life recovery options, please see our Product Disassembly Instructions and End of Life Recovery Options documents available on our website in the resources section of each product in our line.

FREIGHT PROGRAM

Freight charges will be calculated as a percentage of the net product price and added to the invoice at the time of shipment. The continental United States has been divided into three zones. Please use the map below to determine freight charges for the product's destination. Minimum freight charge is \$150. Please let us know if you will be shipping to a residential address or require inside delivery as this requires an additional fee. Also please note we need to be made aware if a liftgate is required prior to delivery. If any requests are made at the time of delivery, applicable charges will apply.

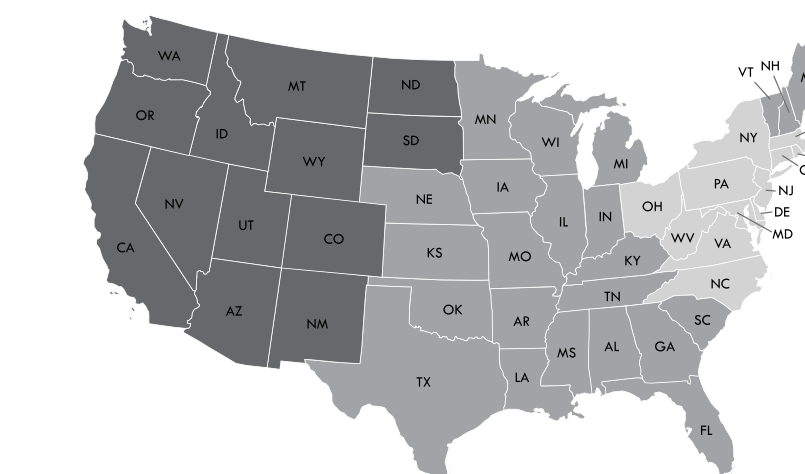

Zone 1 - 4%
Zone 2 - 5%
Zone 3 - 6%

ZONE 1 - 4%

Connecticut
Delaware
New York
New Jersey
Maryland
Massachusetts
North Carolina
Ohio
Pennsylvania
Rhode Island
Virginia
Washington D.C.
West Virginia

ZONE 2 - 5%

Alabama
Arkansas
Canada, Ontario
Canada, Quebec
Florida
Georgia
Iowa
Illinois
Indiana
Kansas
Kentucky
Louisiana
Nebraska
New Hampshire
Oklahoma
Maine
Michigan
Minnesota
Missouri
Mississippi
South Carolina
Tennessee
Texas
Vermont
Wisconsin

ZONE 3 - 6%

Arizona
California
Colorado
Idaho
Montana
Nevada
New Mexico
North Dakota
Oregon
South Dakota
Utah
Washington
Wyoming

Quote Per Project

Alaska
Hawaii
Canada
(outside Ontario & Quebec)
Mexico

General Information

STYLEX PRICE LIST

TEXTILE PARTNERS & APPROVALS

Textile Partners

To customize your furniture performance needs and design vision, Stylex offers a wide selection of in-graded leathers and textiles from Grades A through Y. We've partnered with leading manufacturers on the options, focusing on color, price, durability, and construction. To view our partners and explore our digital carded program with broadly approved textiles, visit [this page](#). We stand by these textiles: They're tried and tested, and will effortlessly fit into any design aesthetic.

Textile Approvals

All textiles must be approved for the product you are specifying. For the related approved textile lists, visit [this page](#).

CAL 117 AND 133 COMPLIANCE

CAL 117-2013

All Stylex seating satisfies the requirements of CAL 117-2013 so long as one of our standard or in-graded fabrics is applied. COM textiles cannot be so guaranteed. Please contact the supplier of COM's directly to determine the fire retardancy of any COM supplied to us.

CAL 133

Most Stylex seating can be ordered to meet the requirements of CAL 133. When ordering, simply specify "CAL 133 compliance required". The upcharge for this option is \$54 list per yard. Please refer to the COM yardage of each model to determine the number of yards required. We do frequently require full-scale burn tests in order to certify CAL 133 before an order will be accepted. Such burn tests may increase normal lead times and do carry additional charges. Please contact customer service for details.

CUSTOMER'S OWN MATERIAL/LEATHER

Customer's own material (COM) and customer's own leather (COL) will generally be upholstered at the price designated in each product's price list. Please be advised, however, that we specifically reserve the right to charge a higher price when we determine that special circumstances, such as unusual repeats or challenging materials, present themselves. All orders for custom coverings must be approved by Stylex before they will be accepted for production. To submit proposed textile for approval, please use the COM form [here](#).

Special Note:

We assume no responsibility for the durability or tailoring quality of any COM or COL. Directional covers in particular may not meet your satisfaction due to the design of certain products. Please be advised that COM and COL orders are not subject to return. If you have doubts about the ultimate appearance of certain coverings, please order a sample done with that specific COM or COL. In addition, while we inspect fabrics for mill imperfections, some are difficult to recognize. We cannot be responsible for defects, color inaccuracies, dye lot variations, or other flaws.

Under no circumstances will we be responsible for COM shortages, flaws, or other such problems. Finally, it is not our responsibility to police the receipt of COM's in order to meet delivery deadlines, and we assume our customers are aware of any undue delay in the shipment of their COM fabrics.

COM fabric and COL leather should be sent prepaid to: Stylex

**Attn: COM/COL - [Your PO #]
740 Coopertown Road
Delanco, NJ 08075**

Clearly mark fabric or leather with the dealers name, purchase order number, and furniture model number of the item to be covered. Actual furniture orders should include the same information, as well as a description of the fabric or leather, including pattern and color number, in order to provide a cross reference.

Yardage requirements shown in the price list are based on non-directional goods of 54" width. Fabrics less than 54" wide or those requiring matching (stripes, prints, or large patterned designs) call for additional yardage. We will be happy to supply yardage requirements for large quantities where economies may be realized.

Add the following yardage for stripes, plaids, or patterns with repeats:

Fabric Width	Plain Fabric	2-14" Repeat	15-24" Repeat	25-27" Repeat	28-36" Repeat
54"	0%	10%	15%	20%	25%
50"	10%	20%	25%	30%	35%
48"	15%	25%	30%	35%	40%
45"	40%	50%	55%	60%	65%
36"	50%	60%	65%	70%	75%

COM/COL FORM

To avoid delay in processing COM orders we request that you submit a sample of your COM fabric stapled to this form which can be downloaded [here](#). If a fabric has a stripe or design, the size of the repeat should be indicated. Please indicate the fabric supplier's name, fabric number, and color. Also indicate the Stylex product on which the fabric will be used.

The fabric supplier must indicate on his shipping labels the dealer name and purchase order number as well as the Stylex model number.

Please Note:

No order may be entered into production or have a shipping date assigned until all related COM is received at the factory.



CENTER OF STRIPE OR DESIGN

TOP OF CHAIR	TOP OF CHAIR
--------------	--------------

1. Size of Repeat

2. Fabric Supplier

3. Fabric Number

4. Color

5. Stylex Product

Contents

<hr/>		<hr/>	
COLORS, MATERIALS, AND FINISHES	5	IDEA STARTERS	13
<hr/>		<hr/>	
STATEMENT OF LINE	6	HOW TO ORDER	14
<hr/>		<hr/>	
OPTIONS AND UPHOLSTERY	7	YOOM: MODULAR	15
<hr/>		<hr/>	
POWER	8	YOOM: PRE-CONFIGURED	23
<hr/>		<hr/>	
SPECIFICATION INFORMATION	9	YOOM SOFT: MODULAR	30
<hr/>		<hr/>	
DIMENSIONS	11	YOOM SOFT: PRE-CONFIGURED	37
<hr/>		<hr/>	

CLICK THE TITLES ABOVE TO NAVIGATE THROUGH THE DOCUMENT
PRODUCT HEADERS ON SUBSEQUENT PAGES LINK BACK TO THIS PAGE

Yoom

COLORS, MATERIALS, AND FINISHES

POWDER COATED PAINTED METAL

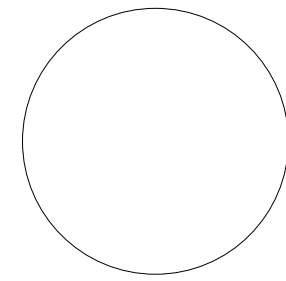

MILK
(MK)

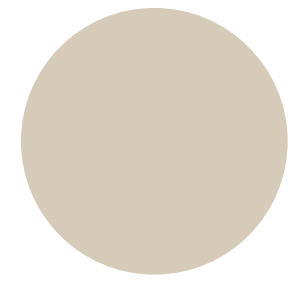

SAND
(SD)

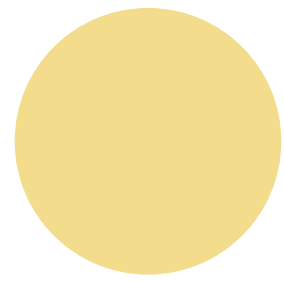

PALE YELLOW
(PY)

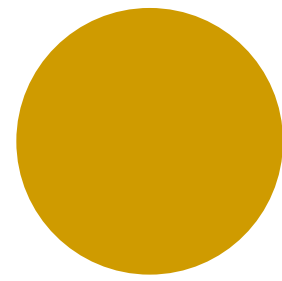

YELLOW
(YL)

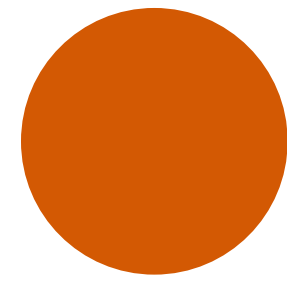

ORANGE
(OR)

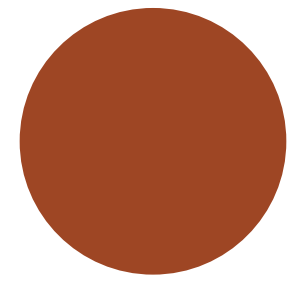

TERRACOTTA
(TC)

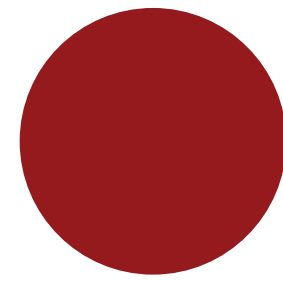

RED
(RD)

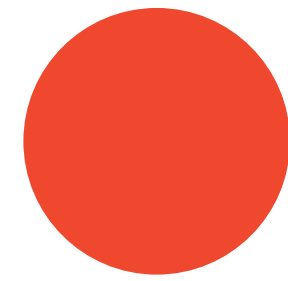

RED ORANGE
(RO)

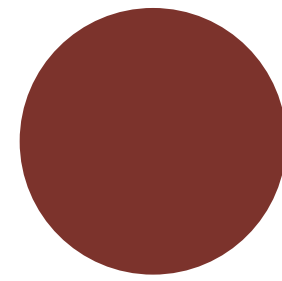

RUSTY RED
(RR)

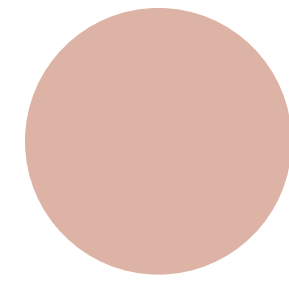

DUSTY PINK
(DP)

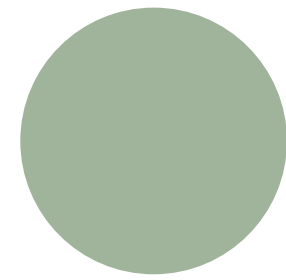

MEADOW GREEN
(MG)

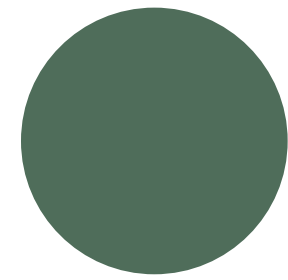

FOREST GREEN
(FG)

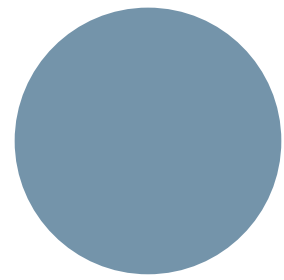

SOFT BLUE
(SB)

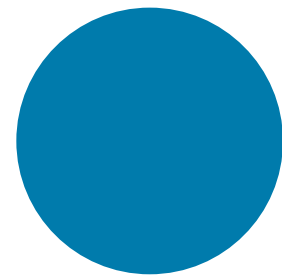

BLUE
(BL)

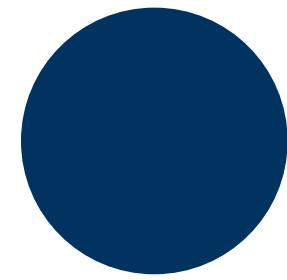

NAVY
(NV)

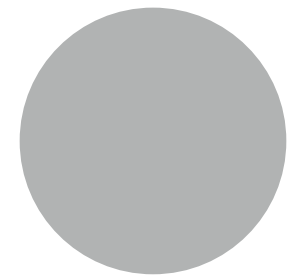

LIGHT GRAY
(LG)



CHAMPAGNE
(CP)

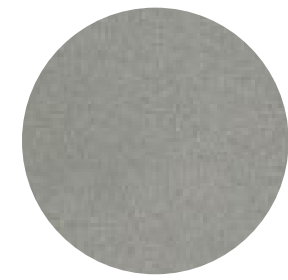

METALLIC SILVER
(MS)

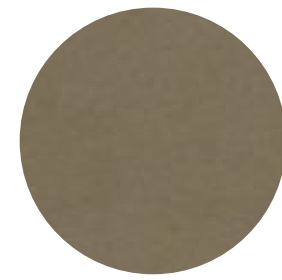

NICKEL
(NK)

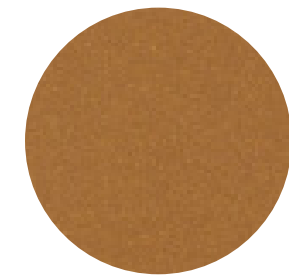

BRASS
(BR)

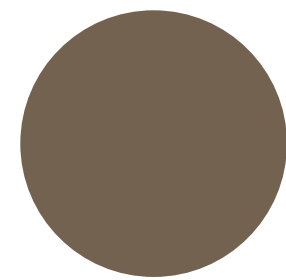

TAUPE
(TP)



DARK BRONZE
(DB)

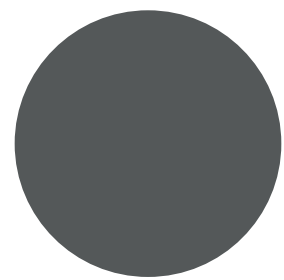

DARK GRAY
(DG)

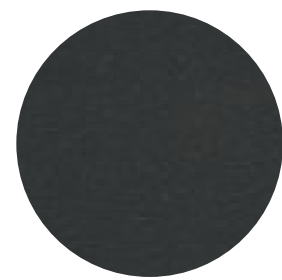

TEXTURED SLATE
(TS)

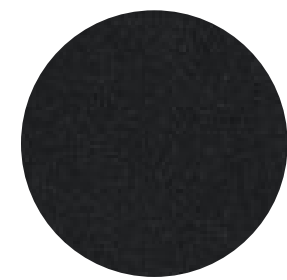

BLACK TWILIGHT
(BT)

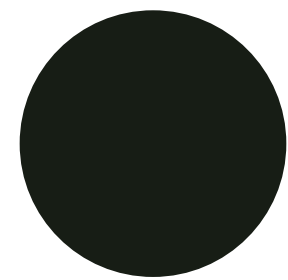

BLACK MATTE
(BM)



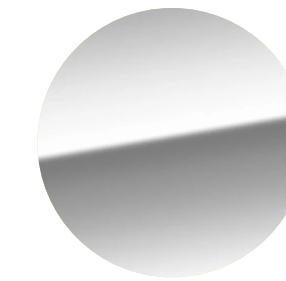







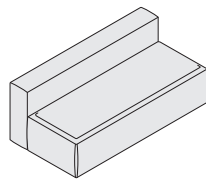
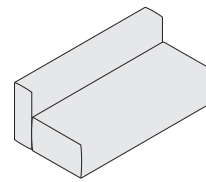
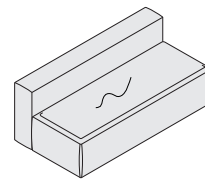
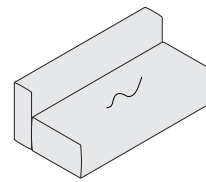
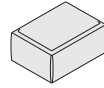
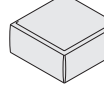
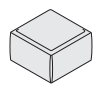
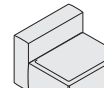
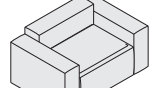
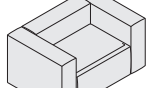
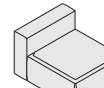
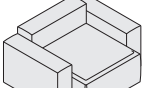

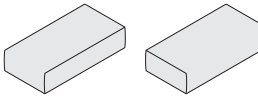
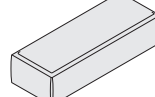
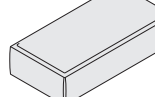
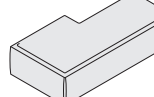
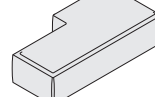
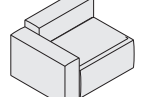
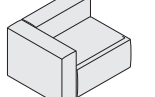
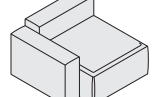
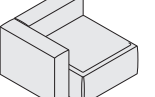
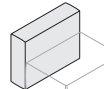
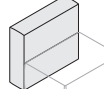
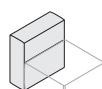
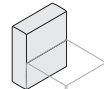
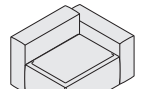
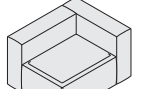
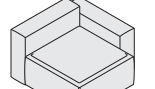
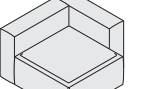
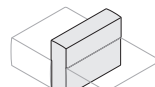
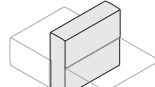
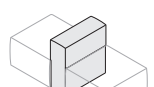
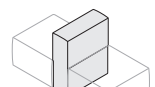
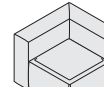
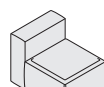

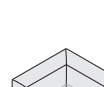

POLISHED METAL

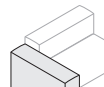
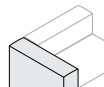
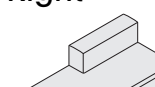

POLISHED
ALUMINUM
(AL)

Yoom

SPECIFICATION GUIDE: STATEMENT OF LINE

OVERVIEW										
<p>Yoom is offered in the following 4 styles. All styles can be applied to the modular and stand-alone components below.</p>		<p>Yoom, Boxed</p> 	<p>Yoom, Rolled</p> 	<p>Yoom Soft, Boxed</p> 	<p>Yoom Soft, Rolled</p> 					
MODULAR			PRE-CONFIGURED							
<p>Seats</p>	<p>Single</p> 	<p>Single Full</p> 	<p>Single Narrow</p> 	<p>Single Chairs</p>	<p>Single Armless</p> 	<p>Single Low Arms</p> 	<p>Single High Arms</p> 	<p>Single Full Armless</p> 	<p>Single Full Low Arms</p> 	<p>Single Full High Arms</p> 
	<p>*Offered in rolled front and rolled side.</p> 	<p>Double*</p> 	<p>Double Full*</p> 		<p>Chaise Right*</p> 	<p>Chaise Left*</p> 	<p>Single R Arm Low</p> 	<p>Single R Arm High</p> 	<p>Single Full R Arm Low</p> 	<p>Single Full R Arm High</p> 
<p>Backs</p>	<p>Single</p> 	<p>Single High</p> 	<p>Single Narrow</p> 	<p>Single Narrow High</p> 	<p>Single L Arm Low</p> 	<p>Single L Arm High</p> 	<p>Single Full L Arm Low</p> 	<p>Single Full L Arm High</p> 		
	<p>Single Thin Back to Back</p> 	<p>Single Thin Back to Back High</p> 	<p>Single Thin Back to Back Narrow</p> 	<p>Single Thin Back to Back Narrow High</p> 	<p>Corner</p> 	<p>Narrow</p> 				
	<p>Double</p> 	<p>Double High</p> 	<p>Single Back to Back</p> 	<p>Corner</p> 	<p>Double Chairs</p>	<p>Double Armless</p> 	<p>Double Low Arms</p> 	<p>Double High Arms</p> 	<p>Double Full Armless</p> 	<p>Double Full Low Arms</p> 
<p>Arms</p>	<p>Single Low</p> 	<p>Single High**</p> 	<p>**Single High Arm is the same model as Single High Back.</p>		<p>Chaises</p>	<p>Chaise Right</p> 	<p>Chaise Left</p> 			
<p>Privacy Screens</p>	<p>25"</p> 	<p>34"</p> 	<p>43"</p> 							

PRODUCT INFORMATION

Design

Stylex/Anthony Land

Construction

Yoom utilizes foam within its construction offering a tailored look, while Yoom Soft utilizes both foam and a down cover, creating a lived in, relaxed look with visible comfort wrinkles.

Glides

Yoom is available with 3 glide options: plastic (recommended for easier movement on carpet), felt (recommended for easier movement on hard floors), and rubber (recommended for static positioning). There is 1" of clearance between the floor and all Yoom components.

Casters

Yoom single seats and chairs (without arms) are available with 2 caster options: hard and soft.

Round Metal Legs

Yoom round metal legs increase seating height by 2". Legs are available in all standard Stylex powder paint and polished aluminum finishes.

Ganging

All individual units may be connected to one another with the use of a forked latch system. Yoom utilizes a ganging system that causes foam compression. For precise ganged layout dimensions, please reach out to: designapplication@stylexseating.com

Testing

Manufactured to comply with:
ANSI/BIFMA X5.4 Public and Lounge Seating Standard

Environment

Greenguard Gold Certified
LEVEL® 2

Yoom

SPECIFICATION GUIDE: OPTIONS AND UPHOLSTERY

OPTIONS

Glide Options

Plastic, Felt, or Rubber

Caster Options

Hard or Soft Wheel
(Available on Yoom single seats and chairs without arms only.)

Round Metal Leg

Available in standard Stylex powder paints and Polished AL

Ganging

Forked Latch System

UPHOLSTERY

PRODUCT INFORMATION

Design

Stylex/Anthony Land

Construction

Yoom utilizes foam within its construction offering a tailored look, while Yoom Soft utilizes both foam and a down cover, creating a lived in, relaxed look with visible comfort wrinkles.

Glides

Yoom is available with 3 glide options: plastic (recommended for easier movement on carpet), felt (recommended for easier movement on hard floors), and rubber (recommended for static positioning). There is 1" of clearance between the floor and all Yoom components.

Casters

Yoom single seats and chairs (without arms) are available with 2 caster options: hard and soft.

Round Metal Legs

Yoom round metal legs increase seating height by 2". Legs are available in all standard Stylex powder paint and polished aluminum finishes.

Ganging

All individual units may be connected to one another with the use of a forked latch system. Yoom utilizes a ganging system that causes foam compression. For precise ganged layout dimensions, please reach out to: designapplication@stylexseating.com

Testing

Manufactured to comply with:
ANSI/BIFMA X5.4 Public and Lounge Seating Standard





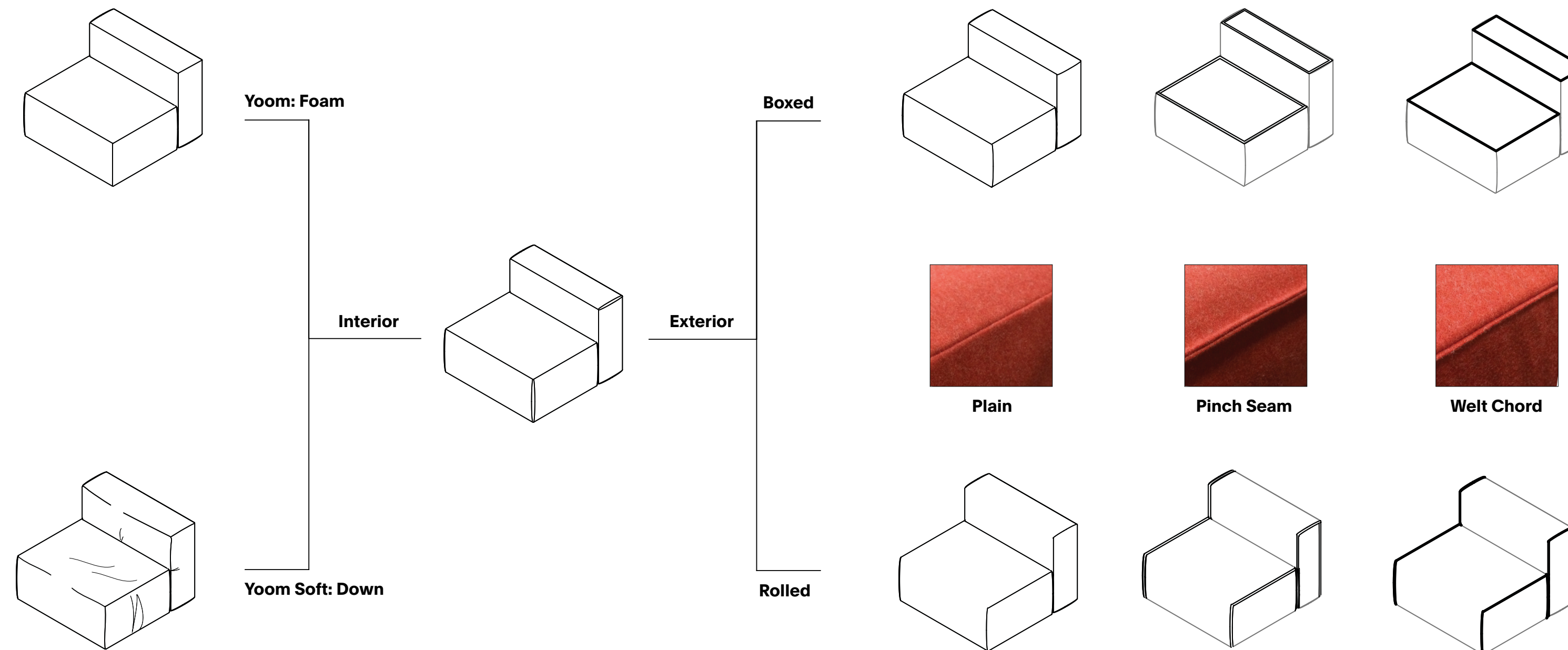





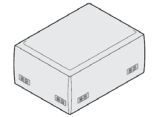
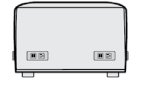
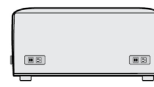
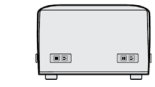
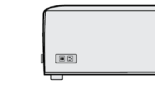
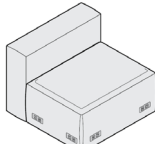

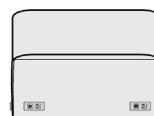
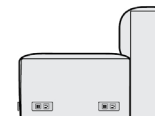
Environment

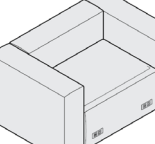
Greenguard Gold Certified
LEVEL® 2

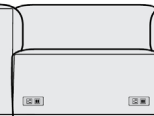

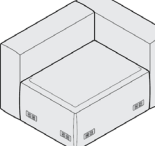
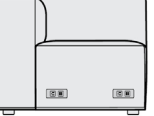
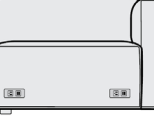
Yoom

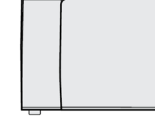
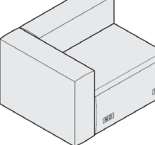
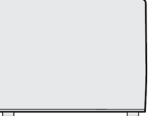
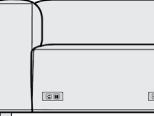
SPECIFICATION GUIDE: POWER

POWER PORTS	RIGHT	FRONT	LEFT	REAR
Single Seat 	Position 5 C15/C25  Position 4 C14/C24	Position 3 C13/C23  Position 2 C12/C22	Position 1 C11/C21  Position 8 C18/C28	Position 6 C16/C26  Position 7 C17/C27
Single Chair 	Position 5 C15/C25  Position 4 C14/C24	Position 3 C13/C23  Position 2 C12/C22	Position 1 C11/C21  Position 8 C18/C28	No Ports 
Single Chair w/ Arms 	No Ports 	Position 3 C13/C23  Position 2 C12/C22	No Ports 	No Ports 
Single Chair w/ Left Arm 	Position 5 C15/C25  Position 4 C14/C24	Position 3 C13/C23  Position 2 C12/C22	No Ports 	No Ports 
Single Chair w/ Right Arm 	No Ports 	Position 3 C13/C23  Position 2 C12/C22	Position 1 C11/C21  Position 8 C18/C28	No Ports 

To Order Power Select Below

1. Length and Harness End

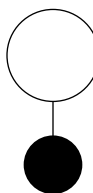

Length and Harness End

C1	10' CORD LENGTH W/NEMA 5-15P	+435
C2	20' CORD LENGTH W/NEMA 5-15P	+466
W1	12' BX WHIP (FOR HARDWIRING)	+1,079
W2	24' BX WHIP (FOR HARDWIRING)	+1,261

2. Position

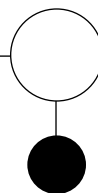

Position

1	POSITION 1
2	POSITION 2
3	POSITION 3
4	POSITION 4
5	POSITION 5
6	POSITION 6
7	POSITION 7
8	POSITION 8

See above for power port location restrictions

3. Power Port Finish

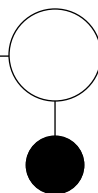

Standard Powder Coated Metal

BL	BLUE	DP	DUSTY PINK	NV	NAVY	SD	SAND
BM	BLACK MATTE	FG	FOREST GREEN	OR	ORANGE	TC	TERRACOTTA
BR	BRASS	LG	LIGHT GRAY	PY	PALE YELLOW	TP	TAUPE
BT	BLACK TWILIGHT	MG	MEADOW GREEN	RD	RED	TS	TEXTURED SLATE
CP	CHAMPAGNE	MK	MILK	RO	RED ORANGE	YL	YELLOW
DB	DARK BRONZE	MS	METALLIC SILVER	RR	RUSTY RED		
DG	DARK GRAY	NK	NICKEL	SB	SOFT BLUE		

PRODUCT INFORMATION

Design

In-Seat Power Ports With 10' or 20' Cord

Power Port Cord Length and Harness End

C1X has a 10' power cord w/ NEMA 5-15P

C2X has a 20' Power cord w/ NEMA 5-15P

W1X 12' BX whip (for hardwiring)

W1X 24' BX whip (for hardwiring)

Power Port Location

The power port location is determined by its last digit.

Examples:

- A C14 power port has a 10' power cord and is located on the right side of a chair, as determined from a seated position, or the right forward position of a bench.
- A C21 power port has a 20' power cord and is located on the left side of a chair, as determined from a seated position, or the left forward position of a bench.

Multiple power ports may be ordered per unit. The pricing shown is for each power port ordered.

In-Seat Power Port Finish

Select power port finish from one of the standard Stylex powder paints.

Power In Chairs And Benches

You can specify power units to be hardwired or equipped with a 3-prong plug. These units feature one USB-A port, one USB-C port, and a standard grounded 3-prong electrical outlet.

Yoom

SPECIFICATION GUIDE: ROLLED SIDE

ROLLED SIDE

Double Seat Rolled Side

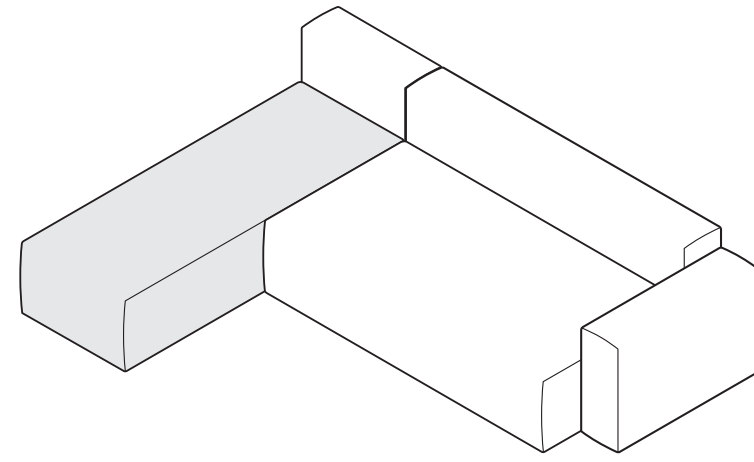

Double Full Seat Rolled Side

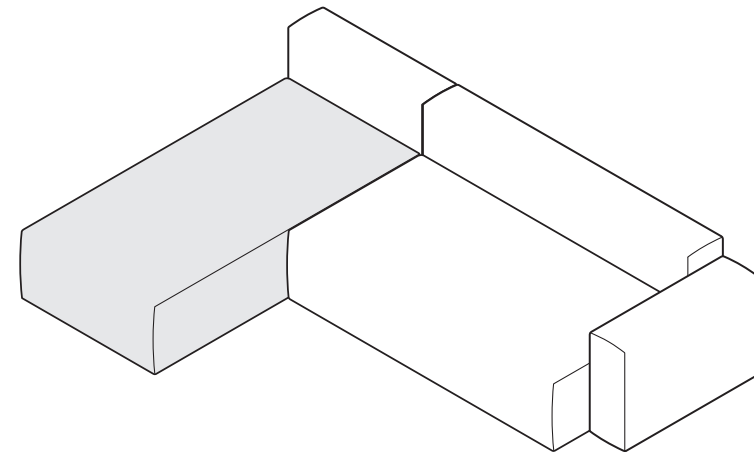

Chaise Seat (right shown) Rolled Side

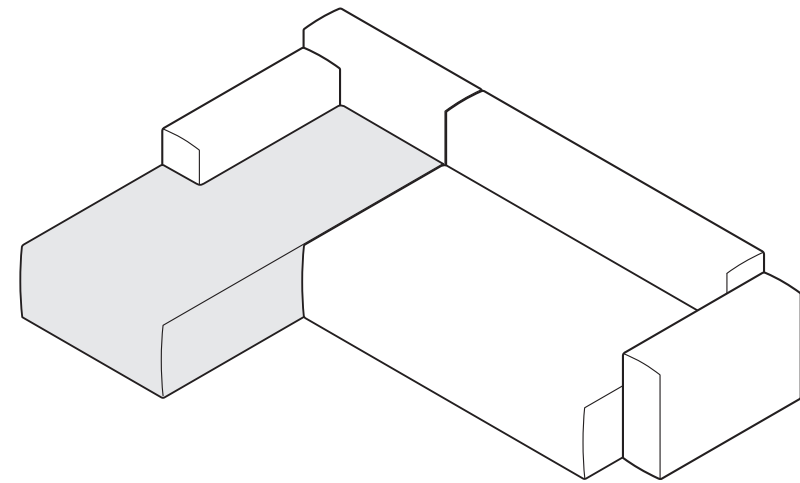

PRODUCT INFORMATION

Rolled Side

The option of a 'Rolled Side' is offered on Double Seats, Double Full Seats, Chaise Right, and Chaise Left units capping the end of a layout. Seam direction is altered from the standard 'Rolled Front' for a consistent pattern with adjacent seats. This enables striped and patterned fabrics to line up across units. Please refer to the sample layouts on this page as a reference for each 'Rolled Side' unit. Selection of rolled side units will be reviewed and suggested by Stylex per customer layout.

Yoom

SPECIFICATION GUIDE: PRIVACY SCREENS

PRIVACY SCREENS

YM061 25" Privacy Screen

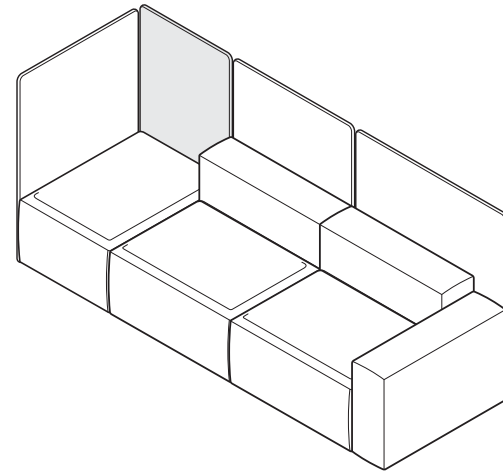

YM062 34" Privacy Screen

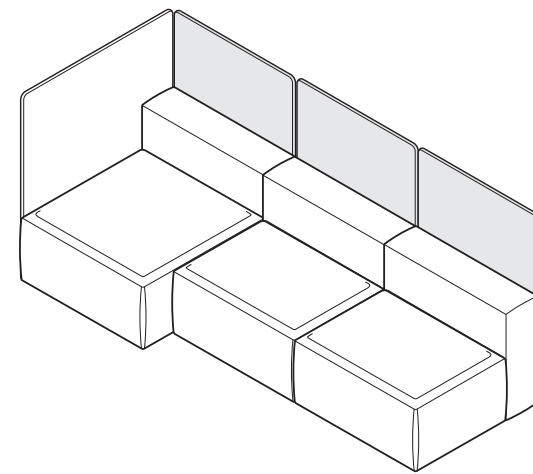
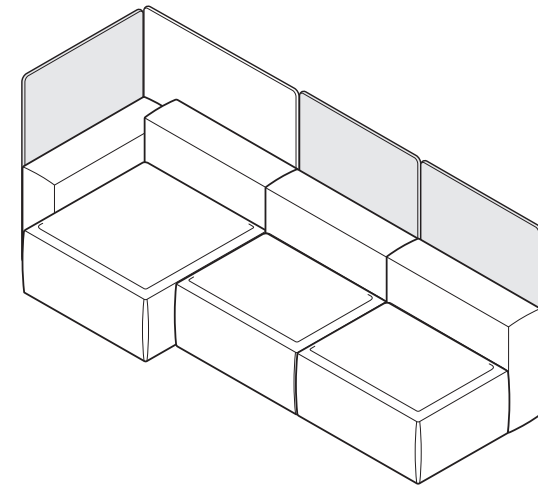
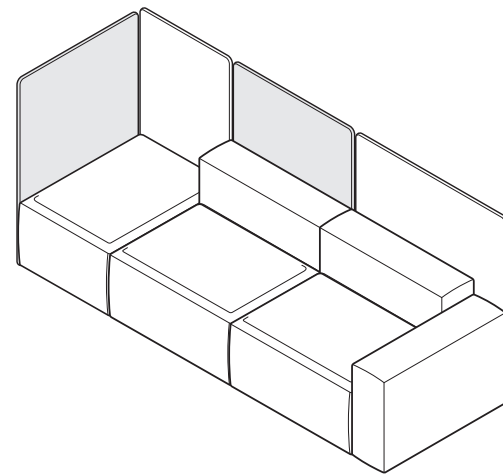

YM063 43" Privacy Screen

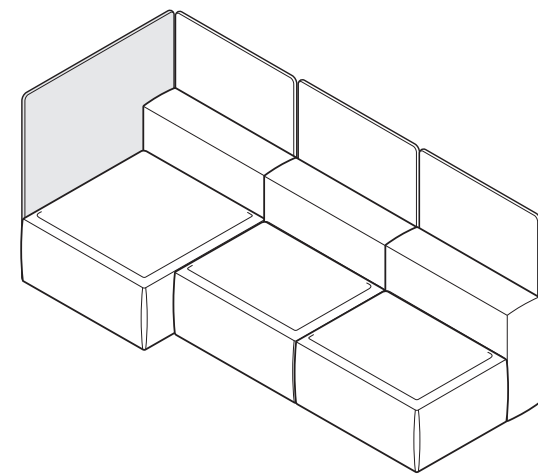
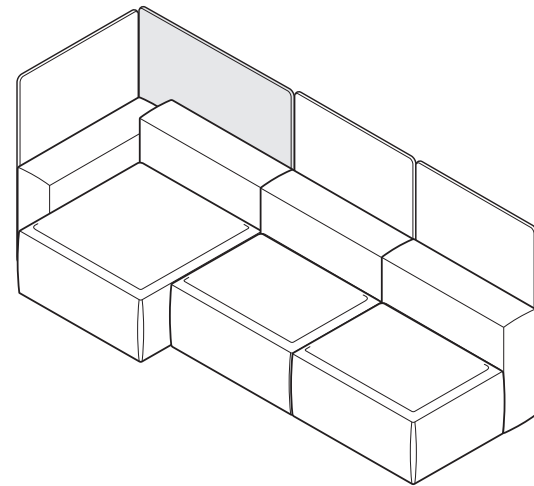

PRODUCT INFORMATION

Privacy Screens

Yoom Privacy Screens are field installed and can be installed on seats, backs and arms. They can be used to provide privacy and definition to the space or can be directly used as a back with throw pillows in lieu of the traditional Yoom Backs or Back to Backs. Three different privacy screen widths have been created to keep pace with the specifiers creativity.

Yoom

SPECIFICATION GUIDE: DIMENSIONS

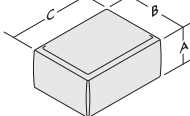
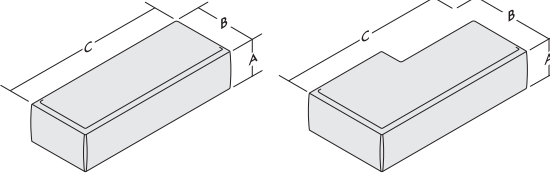
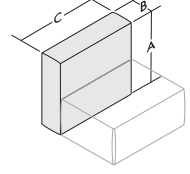
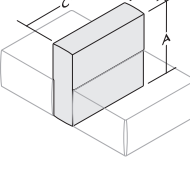
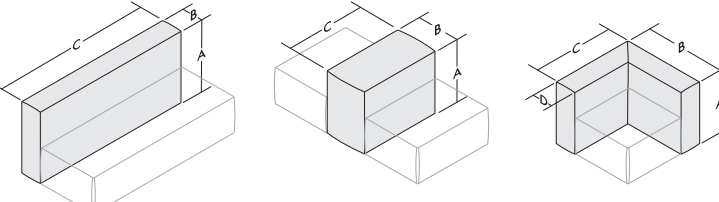
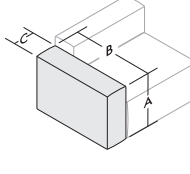
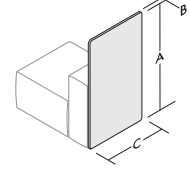
DIMENSIONS - YOOM	MODULAR (BOXED & ROLLED)			
Seats A. Height B. Depth C. Width  	Single A. 15" B. 27" C. 36"	Single Full A. 15" B. 36" C. 36"	Single Narrow A. 15" B. 27" C. 27"	
	Double A. 15" B. 27" C. 70"	Double Full A. 15" B. 36" C. 70"	Chaise Right A. 15" B. 36" C. 70"	Chaise Left A. 15" B. 36" C. 70"
Backs A. Height B. Depth C. Width D. Depth of Back (Corner)   	Single A. 26" B. 9" C. 36"	Single High A. 30" B. 9" C. 36"	Single Narrow A. 26" B. 9" C. 27"	Single Narrow High A. 30" B. 9" C. 27"
	Single Thin Back to Back A. 26" B. 9" C. 36"	Single Thin Back to Back High A. 30" B. 9" C. 36"	Single Thin Back to Back Narrow A. 26" B. 9" C. 27"	Single Thin Back to Back Narrow High A. 30" B. 9" C. 27"
	Double A. 26" B. 9" C. 70"	Double High A. 30" B. 9" C. 70"	Single Back to Back A. 26" B. 18" C. 36"	Corner A. 26" B. 36" C. 36" D. 9"
Arms A. Height B. Depth C. Width 	Single Low A. 22" B. 36" C. 10.5"			
Screens A. Height B. Depth C. Width 	25" A. 45" B. 1.5" C. 25"	34" A. 45" B. 1.5" C. 34"	43" A. 45" B. 1.5" C. 43"	

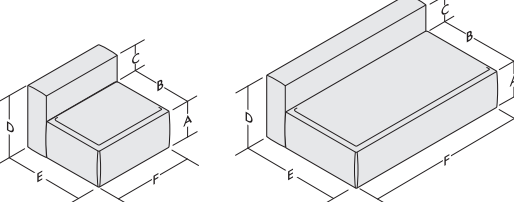
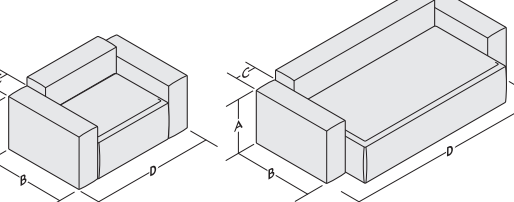
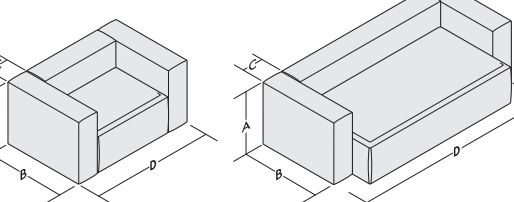
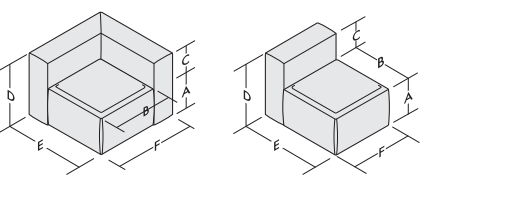
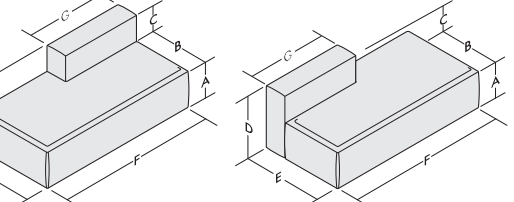
DIMENSIONS - YOOM	PRE-CONFIGURED (BOXED & ROLLED)					
Armless Chair A. Seat Height B. Seat Depth C. Back Height D. Overall Height E. Overall Depth F. Overall Width 	Single A. 15" B. 27" C. 11" D. 26" E. 36" F. 36"	Single Full A. 15" B. 36" C. 11" D. 26" E. 45" F. 36"			Double A. 15" B. 27" C. 11" D. 26" E. 36" F. 70"	Double Full A. 15" B. 36" C. 11" D. 26" E. 45" F. 70"
	Arm Low A. Arm Height B. Arm Depth C. Arm Width D. Overall Width Arms 	Single A. 22" B. 36" C. 10.5" D. 56"	Single Full A. 22" B. 36" C. 10.5" D. 56"	Single L/R Arm A. 22" B. 36" C. 10.5" D. 46"	Single Full L/R Arm A. 22" B. 36" C. 10.5" D. 46"	Double A. 22" B. 36" C. 10.5" D. 90"
Arm High A. Arm Height B. Arm Depth C. Arm Width D. Overall Width Arms 	Single A. 26" B. 36" C. 10.5" D. 56"	Single Full A. 26" B. 36" C. 10.5" D. 56"	Single L/R Arm A. 26" B. 36" C. 10.5" D. 46"	Single Full L/R Arm A. 26" B. 36" C. 10.5" D. 46"	Double A. 26" B. 36" C. 10.5" D. 90"	Double Full A. 26" B. 36" C. 10.5" D. 90"
	Corner & Single Narrow Chair A. Seat Height B. Seat Depth C. Back Height D. Overall Height E. Overall Depth F. Overall Width 	Corner A. 15" B. 25" C. 11" D. 26" E. 36" F. 36"	Single Narrow A. 15" B. 25" C. 11" D. 26" E. 36" F. 27"			
Chaise A. Seat Height B. Seat Depth C. Back Height D. Overall Height E. Overall Depth F. Overall Width G. Back Width 	Chaise Left or Right A. 15" B. 25" C. 11" D. 26" E. 36" F. 70" G. 36"					

Yoom Soft

SPECIFICATION GUIDE: DIMENSIONS

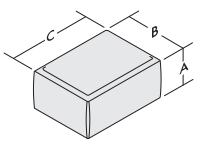
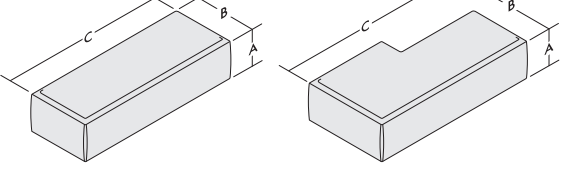
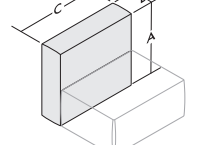
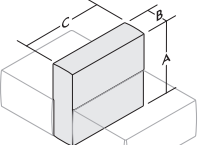
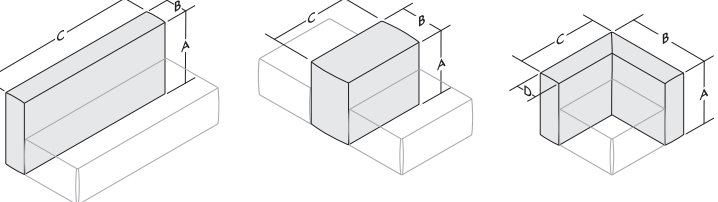
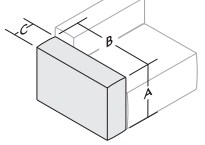
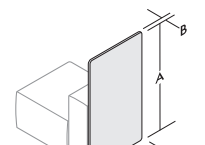
DIMENSIONS - YOOM SOFT	MODULAR (BOXED & ROLLED)			
Seats A. Height B. Depth C. Width  	Single A. 15" B. 27.25" C. 36.25"	Single Full A. 15" B. 36.25" C. 36.25"	Single Narrow A. 15" B. 27.25" C. 27.25"	
	Double A. 15" B. 27.25" C. 70.25"	Double Full A. 15" B. 36.25" C. 70.25"	Chaise Right A. 15" B. 36.25" C. 70.25"	Chaise Left A. 15" B. 36.25" C. 70.25"
Backs A. Height B. Depth C. Width D. Depth of Back (Corner)   	Single A. 26" B. 9" C. 36.25"	Single High A. 30" B. 9" C. 36.25"	Single Narrow A. 26" B. 9" C. 27.25"	Single Narrow High A. 30" B. 9" C. 27.25"
	Single Thin Back to Back A. 26" B. 9" C. 36.25"	Single Thin Back to Back High A. 30" B. 9" C. 36.25"	Single Thin Back to Back Narrow A. 26" B. 9" C. 27.25"	Single Thin Back to Back Narrow High A. 30" B. 9" C. 27.25"
	Double A. 26" B. 9" C. 70.25"	Double High A. 30" B. 9" C. 70.25"	Single Back to Back A. 26" B. 18" C. 36.25"	Corner A. 26" B. 36.25" C. 36.25" D. 9"
Arms A. Height B. Depth C. Width 	Single Low A. 22" B. 36.25" C. 10.375"			
Screens A. Height B. Depth C. Width 	25" A. 45" B. 1.5" C. 25"	34" A. 45" B. 1.5" C. 34"	43" A. 45" B. 1.5" C. 43"	

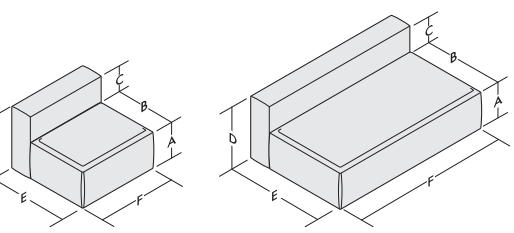
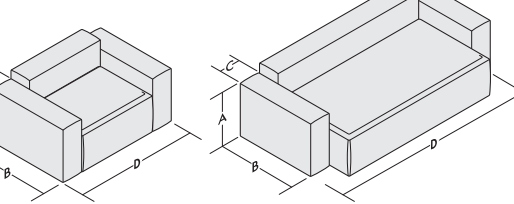
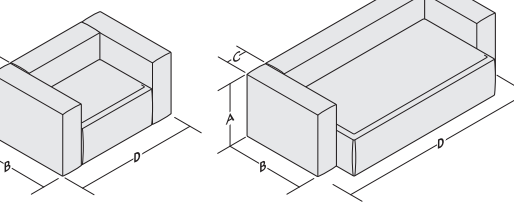
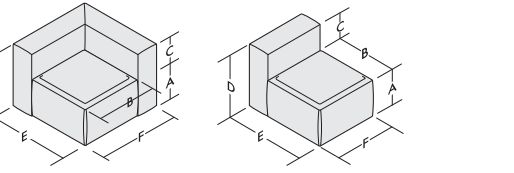
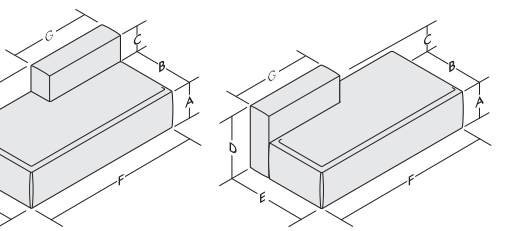
DIMENSIONS - YOOM SOFT	PRE-CONFIGURED (BOXED & ROLLED)					
Armless Chair A. Seat Height B. Seat Depth C. Back Height D. Overall Height E. Overall Depth F. Overall Width 	Single A. 15" B. 25" C. 11" D. 26" E. 36.25" F. 36.25"	Single Full A. 15" B. 34" C. 11" D. 26" E. 45.25" F. 36.25"			Double A. 15" B. 25" C. 11" D. 26" E. 36.25" F. 70.25"	Double Full A. 15" B. 34" C. 11" D. 26" E. 45.25" F. 70.25"
	Arm Low A. Arm Height B. Arm Depth C. Arm Width D. Overall Width Arms 	Single A. 22" B. 36.25" C. 10.375" D. 55.25"	Single Full A. 22" B. 36.25" C. 10.375" D. 55.25"	Single L/R Arm A. 22" B. 36.25" C. 10.375" D. 45.75"	Single Full L/R Arm A. 22" B. 36.25" C. 10.375" D. 45.75"	Double A. 22" B. 36.25" C. 10.375" D. 89.25"
Arm High A. Arm Height B. Arm Depth C. Arm Width D. Overall Width Arms 	Single A. 26" B. 36.25" C. 10.375" D. 55.25"	Single Full A. 26" B. 36.25" C. 10.375" D. 55.25"	Single L/R Arm A. 26" B. 36.25" C. 10.375" D. 45.75"	Single Full L/R Arm A. 26" B. 36.25" C. 10.375" D. 45.75"	Double A. 26" B. 36.25" C. 10.375" D. 89.25"	Double Full A. 26" B. 36.25" C. 10.375" D. 89.25"
	Corner & Single Narrow Chair A. Seat Height B. Seat Depth C. Back Height D. Overall Height E. Overall Depth F. Overall Width 	Corner A. 15" B. 25" C. 11" D. 26" E. 36.25" F. 36.25"	Single Narrow A. 15" B. 25" C. 11" D. 26" E. 36.25" F. 27.25"			
Chaise A. Seat Height B. Seat Depth C. Back Height D. Overall Height E. Overall Depth F. Overall Width G. Back Width 	Chaise Left or Right A. 15" B. 25" C. 11" D. 26" E. 36.25" F. 70.25" G. 36.25"					

Yoom

SPECIFICATION GUIDE: IDEA STARTERS

IDEA STARTERS

Idea Starter 1



Idea Starter 2



Idea Starter 3



Idea Starter 4



Idea Starter 5



Idea Starter 6



Idea Starter 7



Idea Starter 8



Idea Starter 9



Idea Starter 10



Idea Starter 11



Idea Starter 12



ORDERING GUIDE

Idea Starters Online and in CET

At Stylex, we have a constant eye towards making our products easy to specify. Our Design Application team is working on layouts every day, so we have built a library online of the most requested layouts, with all the accompanying information, files, and pricing. We believe these will make our products easier to specify, and in turn help kick start your project. You can also find these in CET, please check out our 'Idea Starters' tab on for the easiest way to drag-and-drop right into your layout. Visit [Stylexdesign.com/idea-starters](https://stylexdesign.com/idea-starters) to get started.

Yoom

SPECIFICATION GUIDE: HOW TO ORDER

MODEL CODE BREAKDOWN - SEATING

Sample Model Code: **YM911PGGC14SSCOM**

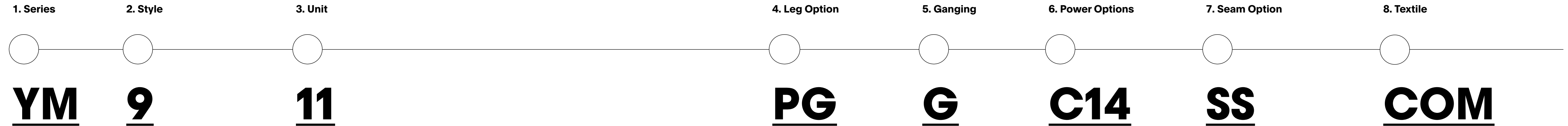

1. Series	2. Style	3. Unit	4. Leg Option	5. Ganging	6. Power Options	7. Seam Option	8. Textile	
YM	9	11	PG	G	C14	SS	COM	
Series YM YOOM	Style 4 SOFT ROLLED SIDE 5 SOFT ROLLED FRONT 6 SOFT BOXED 7 ROLLED SIDE 8 ROLLED FRONT 9 BOXED	Modular Units 11 SINGLE SEAT 12 SINGLE FULL SEAT 13 SINGLE NARROW SEAT 14 DOUBLE SEAT 15 DOUBLE FULL SEAT 16 CHAISE RIGHT 17 CHAISE LEFT 31 SINGLE BACK 32 SINGLE HIGH BACK 33 SINGLE NARROW BACK 34 DOUBLE BACK 35 DOUBLE HIGH BACK 36 SINGLE BACK TO BACK 37 CORNER BACK 38 SINGLE NARROW HIGH BACK 39 SINGLE THIN BACK TO BACK 40 SINGLE HIGH THIN BACK TO BACK 41 SINGLE NARROW THIN BACK TO BACK 42 SINGLE NARROW HIGH THIN BACK TO BACK 51 SINGLE LOW ARM 61 25" PRIVACY SCREEN 62 34" PRIVACY SCREEN 63 43" PRIVACY SCREEN	Pre-Configured Units 113100 SINGLE CHAIR ARMLESS 113131P SINGLE CHAIR WITH HIGH ARMS 113131R SINGLE CHAIR WITH RIGHT HIGH ARM 113131L SINGLE CHAIR WITH LEFT HIGH ARM 113151P SINGLE CHAIR WITH LOW ARMS 113151R SINGLE CHAIR WITH RIGHT LOW ARM 113151L SINGLE CHAIR WITH LEFT LOW ARM 123100 SINGLE FULL CHAIR ARMLESS 123131P SINGLE FULL CHAIR WITH HIGH ARMS 123131R SINGLE FULL CHAIR WITH RIGHT HIGH ARM 123131L SINGLE FULL CHAIR WITH LEFT HIGH ARM 123151P SINGLE FULL CHAIR WITH LOW ARMS 123151R SINGLE FULL CHAIR WITH RIGHT LOW ARM 123151L SINGLE FULL CHAIR WITH LEFT LOW ARM 143400 DOUBLE CHAIR ARMLESS 143431P DOUBLE CHAIR WITH HIGH ARMS 143451P DOUBLE CHAIR WITH LOW ARMS 153400 DOUBLE FULL CHAIR ARMLESS 153431P DOUBLE FULL CHAIR WITH HIGH ARMS 153451P DOUBLE FULL CHAIR WITH LOW ARMS 1631 CHAISE RIGHT WITH BACK 1731 CHAISE LEFT WITH BACK 1337 CORNER CHAIR 1333 NARROW CHAIR	Leg Options Glides PG PLASTIC GLIDE FG FELT GLIDE RG RUBBER GLIDE Casters CH HARD WHEEL CS SOFT WHEEL Note: Casters only available on single seats and chairs. Leg L1 ROUND LEG Note: Legs increase seating height by 2".	Ganging ~ NONE G GANGING	Cord Length and Connection Type C1 10' POWER CORD C2 20' POWER CORD W1 12' HARDWIRE W2 24' HARDWIRE Power Position 1 POSITION 1 2 POSITION 2 3 POSITION 3 4 POSITION 4 5 POSITION 5 6 POSITION 6 7 POSITION 7 8 POSITION 8 Power Port Color Standard Powder Coat See page 5 for standard powder coat offerings.	Seam Options SS SINGLE SEAM ON ALL EDGES SP PINCH SEAM ON TOP EDGES SW STANDARD WELT CORD ON ALL EDGES	Textile Grades COM CUSTOMER'S OWN MATERIAL A GRADE A B GRADE B C GRADE C D GRADE D E GRADE E F GRADE F G GRADE G H GRADE H I GRADE I J GRADE J K GRADE K L GRADE L M GRADE M Leather Grades COL CUSTOMER'S OWN LEATHER W GRADE W X GRADE X Y GRADE Y E1 GRADE E1 E2 GRADE E2 Note: Leather only available on Yoom Soft units.

Yoom

MODULAR: SEATS

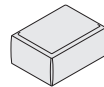
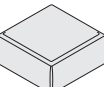
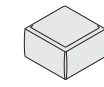
TITLE	SERIES	STYLE	UNIT	DIMENSIONS	YDG	Textile Upholstery Grades														
						COM	A	B	C	D	E	F	G	H	I	J	K	L	M	
Single Seat 	Boxed	YM	9	11	36W x 27D x 15H	2.5	1,574	1,771	1,877	1,982	2,087	2,196	2,311	2,430	2,567	2,748	2,961	3,173	3,385	3,599
	Rolled Front	YM	8	11	36W x 27D x 15H	2.5	1,574	1,761	1,867	1,966	2,066	2,169	2,282	2,393	2,524	2,696	2,901	3,106	3,305	3,510
Single Full Seat 	Boxed	YM	9	12	36W x 36D x 15H	3.3	1,874	2,130	2,270	2,406	2,545	2,683	2,836	2,990	3,170	3,404	3,682	3,961	4,237	4,514
	Rolled Front	YM	8	12	36W x 36D x 15H	3.3	1,874	2,130	2,270	2,406	2,545	2,683	2,836	2,990	3,170	3,404	3,682	3,961	4,237	4,514
Single Narrow Seat 	Boxed	YM	9	13	36W x 36D x 15H	1.7	1,275	1,405	1,473	1,541	1,612	1,681	1,757	1,832	1,923	2,040	2,179	2,319	2,456	2,595
	Rolled Front	YM	8	13	27W x 27D x 15H	2	1,275	1,430	1,512	1,593	1,675	1,760	1,853	1,944	2,051	2,193	2,359	2,526	2,692	2,860

To Order Select Below

1. Series/Style

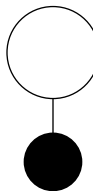

YM9

**Yoom
Boxed**

YM8

**Yoom
Rolled Front**

2. Unit

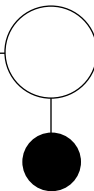

Unit

11 SINGLE SEAT

12 SINGLE FULL SEAT

13 SINGLE NARROW SEAT

3. Seam Options

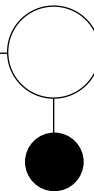

Seam Options

SS SINGLE SEAM ON ALL EDGES

SP PINCH SEAM ON TOP EDGES
SINGLE SEAM ON SIDE EDGES

SW STANDARD WELT CORD
ON ALL EDGES **+10% OF
COM LIST**

4. Glides/Casters/Legs

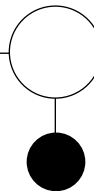

Glides

PG PLASTIC GLIDE

FG FELT GLIDE

RG RUBBER GLIDE

Glide Recommendations
For easier movement, order Plastic
Glides for carpet, Felt Glides for hard
floors and Rubber Glides for static
positioning.

Casters

CH HARD WHEEL CASTER **+89**

CS SOFT WHEEL CASTER **+89**

Recommended for mobility in
collaborative settings.

Legs

L1 ROUND METAL LEGS **+156**

Round Legs increase seating height by 2".
Round Legs are available in standard Stylex
powder coated painted metal finishes and
Polished Aluminum.

5. Power

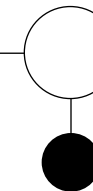

Power

Refer to power
ordering steps
on [page 8](#).

6. Options

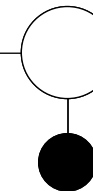

Options

G GANGING

7. Upholstery

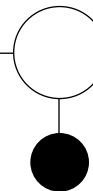

Upholstery

See [general information
section for details on textile
program and COM/COL
information.](#)

Yoom Rolled textiles must be cut up
the roll. Yoom is designed to have a
casual look and feel. It is meant to
show wrinkling with most fabrics.

To specify leather, use Yoom Soft
found on [page 30](#).

Yoom

MODULAR: SEATS

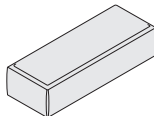
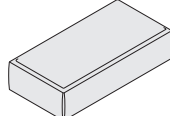
TITLE	SERIES	STYLE	UNIT	DIMENSIONS	YDG	Textile Upholstery Grades														
						COM	A	B	C	D	E	F	G	H	I	J	K	L	M	
Double Seat 	Boxed	YM	9	14	70W x 27D x 15H	4.4	2,623	2,965	3,151	3,332	3,518	3,703	3,907	4,112	4,351	4,664	5,036	5,405	5,772	6,147
	Rolled Front	YM	8	14	70W x 27D x 15H	4.3	2,623	2,958	3,141	3,315	3,495	3,676	3,875	4,076	4,307	4,612	4,975	5,338	5,693	6,056
	Rolled Side	YM	7	14	70W x 27D x 15H	5.5	2,623	3,052	3,283	3,509	3,742	3,974	4,228	4,482	4,785	5,174	5,639	6,104	6,560	7,026
Double Full Seat 	Boxed	YM	9	15	70W x 36D x 15H	5.5	3,222	3,652	3,883	4,109	4,342	4,575	4,829	5,084	5,384	5,772	6,238	6,703	7,159	7,625
	Rolled Front	YM	8	15	70W x 36D x 15H	4.3	3,222	3,557	3,740	3,913	4,095	4,277	4,475	4,675	4,907	5,212	5,574	5,938	6,294	6,657
	Rolled Side	YM	7	15	70W x 36D x 15H	5.5	3,222	3,652	3,883	4,109	4,342	4,575	4,829	5,084	5,384	5,772	6,238	6,703	7,159	7,625

To Order Select Below

1. Series/Style

- Yoom Boxed**
- Yoom Rolled Front**
- Yoom Rolled Side**

See [page 9](#) for more information on rolled side specification.

2. Unit

- Unit**
- 14 DOUBLE SEAT
- 15 DOUBLE FULL SEAT

3. Seam Options

- Seam Options**
- SS SINGLE SEAM ON ALL EDGES
- SP PINCH SEAM ON TOP EDGES
SINGLE SEAM ON SIDE EDGES
- SW STANDARD WELT CORD ON ALL EDGES **+10% OF COM LIST**

4. Glides/Casters/Legs

- Glides**
 - PG PLASTIC GLIDE
 - FG FELT GLIDE
 - RG RUBBER GLIDE
 - Legs**
 - L1 ROUND METAL LEGS **+156**
- Round Legs increase seating height by 2". Round Legs are available in standard Stylex powder coated painted metal finishes and Polished Aluminum.
- Glide Recommendations**
For easier movement, order Plastic Glides for carpet, Felt Glides for hard floors and Rubber Glides for static positioning.

5. Power

- Power**
- Refer to power ordering steps on [page 8](#).

6. Options

- Options**
- G GANGING

7. Upholstery

- Upholstery**
- See [general information section](#) for details on textile program and COM/COL information.
- Yoom Rolled textiles must be cut up the roll. Yoom is designed to have a casual look and feel. It is meant to show wrinkling with most fabrics.
- To specify leather, use Yoom Soft found on [page 30](#).

Yoom

MODULAR: SEATS

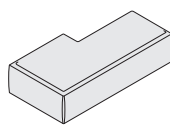
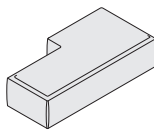
TITLE	SERIES	STYLE	UNIT	DIMENSIONS	YDG	Textile Upholstery Grades														
						COM	A	B	C	D	E	F	G	H	I	J	K	L	M	
Chaise Right Seat 	Boxed	YM	9	16	70W x 36/27D x 15H	5.2	3,222	3,626	3,844	4,055	4,275	4,493	4,731	4,973	5,254	5,622	6,056	6,494	6,923	7,361
	Rolled Front	YM	8	16	70W x 36/27D x 15H	5	3,222	3,616	3,830	4,037	4,251	4,465	4,700	4,934	5,211	5,570	5,997	6,424	6,845	7,272
	Rolled Side	YM	7	16	70W x 36/27D x 15H	5.5	3,222	3,652	3,883	4,109	4,342	4,575	4,829	5,084	5,384	5,772	6,238	6,703	7,159	7,625
Chaise Left Seat 	Boxed	YM	9	17	70W x 36/27D x 15H	5.2	3,222	3,626	3,844	4,055	4,275	4,493	4,731	4,973	5,254	5,622	6,056	6,494	6,923	7,361
	Rolled Front	YM	8	17	70W x 36/27D x 15H	5	3,222	3,616	3,830	4,037	4,251	4,465	4,700	4,934	5,211	5,570	5,997	6,424	6,845	7,272
	Rolled Side	YM	7	17	70W x 36/27D x 15H	5.5	3,222	3,652	3,883	4,109	4,342	4,575	4,829	5,084	5,384	5,772	6,238	6,703	7,159	7,625

To Order Select Below

1. Series/Style

- Yoom Boxed**
- Yoom Rolled Front**
- Yoom Rolled Side**

See [page 9](#) for more information on rolled side specification.

2. Unit

- Unit**
- 16 CHAISE RIGHT SEAT
- 17 CHAISE LEFT SEAT

3. Seam Options

- Seam Options**
- SS SINGLE SEAM ON ALL EDGES
- SP PINCH SEAM ON TOP EDGES
SINGLE SEAM ON SIDE EDGES
- SW STANDARD WELT CORD ON ALL EDGES **+10% OF COM LIST**

4. Glides/Casters/Legs

- Glides**
 - PG PLASTIC GLIDE
 - FG FELT GLIDE
 - RG RUBBER GLIDE
- Glide Recommendations**
For easier movement, order Plastic Glides for carpet, Felt Glides for hard floors and Rubber Glides for static positioning.

5. Power

- Power**
 - L1 ROUND METAL LEGS **+156**
- Round Legs increase seating height by 2". Round Legs are available in standard Stylex powder coated painted metal finishes and Polished Aluminum.

6. Options

- Options**
- G GANGING

7. Upholstery

- Upholstery**
- See general information section for details on textile program and COM/COL information.**
- Yoom Rolled textiles must be cut up the roll. Yoom is designed to have a casual look and feel. It is meant to show wrinkling with most fabrics.
- To specify leather, use Yoom Soft found on [page 30](#).

Yoom

MODULAR: BACKS

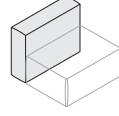
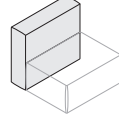
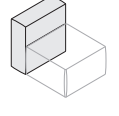
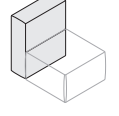
TITLE	SERIES	STYLE	UNIT	DIMENSIONS	Textile Upholstery Grades															
					YDG	COM	A	B	C	D	E	F	G	H	I	J	K	L	M	
Single Back/ Single Arm High 	Boxed	YM	9	31	36W x 9D x 26H	2.2	899	1,071	1,162	1,254	1,346	1,440	1,542	1,644	1,762	1,918	2,104	2,291	2,473	2,661
	Rolled Front	YM	8	31	36W x 9D x 29H	2.1	899	1,063	1,150	1,235	1,324	1,412	1,511	1,605	1,720	1,869	2,044	2,223	2,397	2,570
Single High Back 	Boxed	YM	9	32	36W x 9D x 30H	2.5	974	1,161	1,266	1,364	1,466	1,570	1,682	1,796	1,926	2,097	2,300	2,506	2,706	2,910
	Rolled Front	YM	8	32	36W x 9D x 30H	2.3	974	1,156	1,252	1,346	1,444	1,542	1,647	1,757	1,882	2,044	2,242	2,435	2,628	2,823
Single Narrow Back 	Boxed	YM	9	33	27W x 9D x 26H	1.7	825	951	1,023	1,090	1,159	1,231	1,306	1,384	1,473	1,591	1,729	1,869	2,008	2,145
	Rolled Front	YM	8	33	27W x 9D x 26H	1.7	825	988	1,074	1,160	1,250	1,337	1,435	1,531	1,645	1,796	1,970	2,148	2,322	2,496
Single Narrow High Back 	Boxed	YM	9	38	27W x 9D x 30H	1.9	974	1,110	1,185	1,258	1,332	1,407	1,488	1,571	1,667	1,790	1,940	2,087	2,234	2,382
	Rolled Front	YM	8	38	27W x 9D x 30H	1.8	974	1,110	1,185	1,258	1,332	1,407	1,488	1,571	1,667	1,790	1,940	2,087	2,234	2,382

To Order Select Below

1. Series/Style

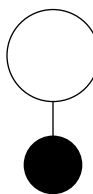

YM9

**Yoom
Boxed**

YM8

**Yoom
Rolled Front**

2. Unit

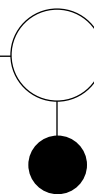

Unit

31 SINGLE BACK/SINGLE ARM HIGH

32 SINGLE HIGH BACK

33 SINGLE NARROW BACK

38 SINGLE NARROW HIGH BACK

3. Seam Options

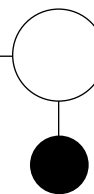

Seam Options

SS SINGLE SEAM ON ALL EDGES

SP PINCH SEAM ON TOP EDGES
SINGLE SEAM ON SIDE EDGES

SW STANDARD WELT CORD
ON ALL EDGES **+10% OF
COM LIST**

4. Upholstery

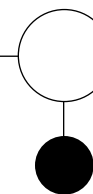

Upholstery

**See general information section
for details on textile program and
COM/COL information.**

Yoom Rolled textiles must be cut up
the roll. Yoom is designed to have a
casual look and feel. It is meant to show
wrinkling with most fabrics.

To specify leather, use Yoom Soft
found on **page 30**.

Yoom

MODULAR: BACKS

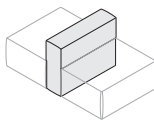
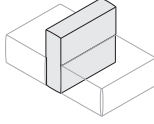
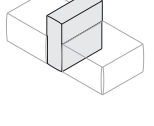
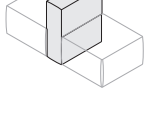
TITLE	SERIES	STYLE	UNIT	DIMENSIONS	Textile Upholstery Grades															
					YDG	COM	A	B	C	D	E	F	G	H	I	J	K	L	M	
Single Thin Back to Back 	Boxed	YM	9	39	36W x 9D x 26H	2.1	1,049	1,211	1,301	1,386	1,474	1,562	1,659	1,757	1,870	2,018	2,196	2,371	2,545	2,723
	Rolled Front	YM	8	39	36W x 9D x 26H	2.1	1,049	1,211	1,301	1,386	1,474	1,562	1,659	1,757	1,870	2,018	2,196	2,371	2,545	2,723
Single Thin Back to Back High 	Boxed	YM	9	40	36W x 9D x 30H	2.2	1,200	1,370	1,463	1,554	1,646	1,739	1,842	1,944	2,063	2,220	2,406	2,591	2,774	2,960
	Rolled Front	YM	8	40	36W x 9D x 30H	2.2	1,200	1,370	1,463	1,554	1,646	1,739	1,842	1,944	2,063	2,220	2,406	2,591	2,774	2,960
Single Thin Back to Back Narrow 	Boxed	YM	9	41	27W x 9D x 26H	1.6	1,049	1,171	1,234	1,298	1,362	1,429	1,499	1,571	1,654	1,762	1,894	2,023	2,153	2,283
	Rolled Front	YM	8	41	27W x 9D x 26H	1.6	1,049	1,171	1,234	1,298	1,362	1,429	1,499	1,571	1,654	1,762	1,894	2,023	2,153	2,283
Single Thin Back to Back Narrow High 	Boxed	YM	9	42	27W x 9D x 30H	1.8	1,200	1,319	1,385	1,447	1,512	1,576	1,649	1,720	1,804	1,913	2,043	2,174	2,302	2,433
	Rolled Front	YM	8	42	27W x 9D x 30H	1.8	1,200	1,336	1,411	1,484	1,556	1,632	1,713	1,797	1,891	2,016	2,166	2,312	2,458	2,608

To Order Select Below

1. Series/Style

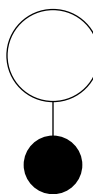

YM9

**Yoom
Boxed**

YM8

**Yoom
Rolled Front**

2. Unit

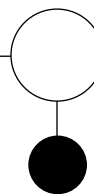

Unit

39 SINGLE THIN BACK TO BACK

40 SINGLE THIN BACK TO BACK HIGH

41 SINGLE THIN BACK TO BACK NARROW

42 SINGLE THIN BACK TO BACK NARROW HIGH

3. Seam Options

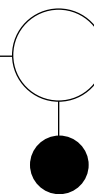

Seam Options

SS SINGLE SEAM ON ALL EDGES

SP PINCH SEAM ON TOP EDGES
SINGLE SEAM ON SIDE EDGES

SW STANDARD WELT CORD ON ALL EDGES **+10% OF COM LIST**

4. Upholstery

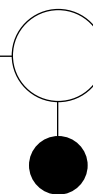

Upholstery

See general information section for details on textile program and COM/COL information.

Yoom Rolled textiles must be cut up the roll. Yoom is designed to have a casual look and feel. It is meant to show wrinkling with most fabrics.

To specify leather, use Yoom Soft found on [page 30](#).

Yoom

MODULAR: BACKS

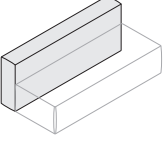
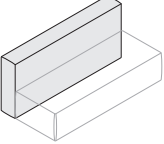
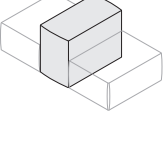
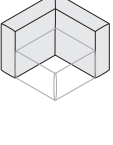
TITLE	SERIES	STYLE	UNIT	DIMENSIONS	YDG	Textile Upholstery Grades														
						COM	A	B	C	D	E	F	G	H	I	J	K	L	M	
Double Back 	Boxed	YM	9	34	70W x 9D x 26H	4.4	1,649	1,991	2,178	2,357	2,543	2,730	2,933	3,137	3,377	3,689	4,062	4,432	4,797	5,169
	Rolled Front	YM	8	34	70W x 9D x 26H	4.1	1,649	1,967	2,138	2,306	2,477	2,647	2,836	3,027	3,247	3,537	3,880	4,224	4,562	4,906
Double High Back 	Boxed	YM	9	35	70W x 9D x 30H	4.8	1,874	2,243	2,440	2,636	2,835	3,035	3,255	3,472	3,730	4,067	4,467	4,866	5,261	5,660
	Rolled Front	YM	8	35	70W x 9D x 30H	4.7	1,874	2,231	2,430	2,619	2,813	3,007	3,221	3,437	3,689	4,015	4,405	4,796	5,180	5,571
Single Back to Back 	Boxed	YM	9	36	36W x 18D x 26H	3.3	1,200	1,457	1,596	1,730	1,870	2,010	2,161	2,315	2,495	2,730	3,007	3,285	3,562	3,841
	Rolled Front	YM	8	36	36W x 18D x 26H	3.2	1,200	1,447	1,581	1,712	1,848	1,983	2,130	2,279	2,453	2,679	2,947	3,218	3,484	3,752
Corner Back 	Boxed	YM	9	37	36W x 36D x 26H	3.5	1,349	1,622	1,773	1,916	2,065	2,214	2,378	2,541	2,732	2,981	3,278	3,577	3,868	4,165
	Rolled Front	YM	8	37	36W x 36D x 26H	3.3	1,349	1,616	1,759	1,897	2,042	2,187	2,343	2,504	2,689	2,931	3,218	3,506	3,791	4,079

To Order Select Below

1. Series/Style

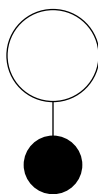

YM9

**Yoom
Boxed**

YM8

**Yoom
Rolled Front**

2. Unit

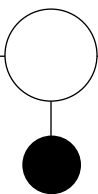

Unit

34 DOUBLE BACK

35 DOUBLE HIGH BACK

36 SINGLE BACK TO BACK

37 CORNER BACK

3. Seam Options

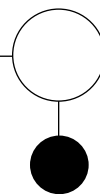

Seam Options

SS SINGLE SEAM ON ALL EDGES

SP PINCH SEAM ON TOP EDGES
SINGLE SEAM ON SIDE EDGES

SW STANDARD WELT CORD ON ALL EDGES **+10% OF COM LIST**

4. Upholstery

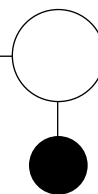

Upholstery

See general information section for details on textile program and COM/COL information.

Yoom Rolled textiles must be cut up the roll. Yoom is designed to have a casual look and feel. It is meant to show wrinkling with most fabrics.

To specify leather, use Yoom Soft found on **page 30**.

Yoom

MODULAR: ARMS

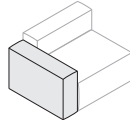
TITLE	SERIES	STYLE	UNIT	DIMENSIONS	Textile Upholstery Grades															
					YDG	COM	A	B	C	D	E	F	G	H	I	J	K	L	M	
Single Arm Low 	Boxed	YM	9	51	36W x 10.5D x 22H	1.9	750	896	974	1,050	1,130	1,208	1,295	1,384	1,485	1,617	1,775	1,933	2,087	2,246
	Rolled Front	YM	8	51	34W x 10.5D x 22H	1.9	750	896	974	1,050	1,130	1,208	1,295	1,384	1,485	1,617	1,775	1,933	2,087	2,246

To Order Select Below

1. Series/Style

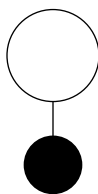

YM9

**Yoom
Boxed**

YM8

**Yoom
Rolled Front**

2. Unit

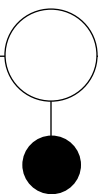

Unit

51 SINGLE ARM LOW

For Modular Single High Arm, refer to Single Back/Single Arm style on [Page 18](#).

3. Seam Options

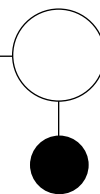

Seam Options

SS SINGLE SEAM ON ALL EDGES

SP PINCH SEAM ON TOP EDGES
SINGLE SEAM ON SIDE EDGES

SW STANDARD WELT CORD ON ALL EDGES **+10% OF COM LIST**

4. Upholstery

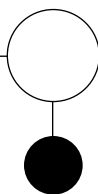

Upholstery

See general information section for details on textile program and COM/COL information.

Yoom Rolled textiles must be cut up the roll. Yoom is designed to have a casual look and feel. It is meant to show wrinkling with most fabrics.

To specify leather, use Yoom Soft found on [page 30](#).

Yoom

MODULAR: PRIVACY SCREEN

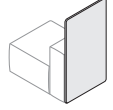
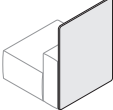
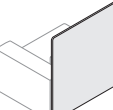
TITLE	SERIES	STYLE	UNIT	DIMENSIONS	Textile Upholstery Grades														
					YDG	COM	A	B	C	D	E	F	G	H	I	J	K	L	M
25 Privacy Screen 	YM	0	61	25W x 1.5D x 45H	2.2	1,049	1,221	1,314	1,405	1,497	1,591	1,692	1,796	1,913	2,069	2,254	2,440	2,623	2,809
34 Privacy Screen 	YM	0	62	34W x 1.5D x 45H	3	1,349	1,579	1,706	1,828	1,953	2,079	2,217	2,354	2,517	2,726	2,978	3,229	3,476	3,726
43 Privacy Screen 	YM	0	63	43W x 1.5D x 45H	3.8	1,649	1,940	2,098	2,250	2,409	2,567	2,741	2,915	3,119	3,382	3,699	4,015	4,326	4,641

To Order Select Below

1. Series/Style

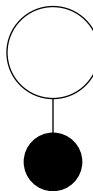

YM0

**Yoom
Privacy Screen**

2. Unit

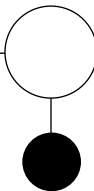

Unit

61 25" PRIVACY SCREEN

62 34" PRIVACY SCREEN

63 43" PRIVACY SCREEN

3. Seam Options

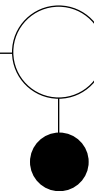

Seam Options

SS SINGLE SEAM ON ALL EDGES

SP PINCH SEAM ON TOP EDGES
SINGLE SEAM ON SIDE EDGES

SW STANDARD WELT CORD
ON ALL EDGES **+10% OF
COM LIST**

4. Upholstery

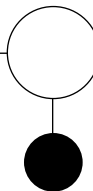

Upholstery

**See general information section
for details on textile program and
COM/COL information.**

Yoom Rolled textiles must be cut up
the roll. Yoom is designed to have a
casual look and feel. It is meant to show
wrinkling with most fabrics.

To specify leather, use Yoom Soft
found on [page 30](#).

Yoom

PRE-CONFIGURED: SINGLE CHAIR

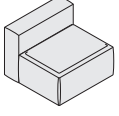
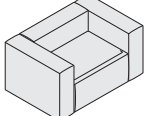
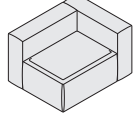
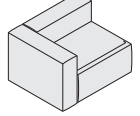
TITLE	SERIES	STYLE	UNIT	DIMENSIONS	YDG	Textile Upholstery Grades														
						COM	A	B	C	D	E	F	G	H	I	J	K	L	M	
Single Chair, Armless 	Boxed	YM	9	113100	36W x 36D x 26H	4.5	2,473	2,842	3,039	3,236	3,433	3,636	3,853	4,074	4,329	4,666	5,065	5,464	5,858	6,260
	Rolled Front	YM	8	113100	36W x 36D x 26H	4.4	2,473	2,824	3,017	3,201	3,390	3,581	3,793	3,998	4,244	4,565	4,945	5,329	5,702	6,080
Single Chair, High Both Arms 	Boxed	YM	9	113131P	56W x 36D x 26H	8.8	4,271	4,984	5,363	5,744	6,125	6,516	6,937	7,362	7,853	8,502	9,273	10,046	10,804	11,582
	Rolled Front	YM	8	113131P	56W x 36D x 26H	8.5	4,271	4,950	5,317	5,671	6,038	6,405	6,815	7,208	7,684	8,303	9,033	9,775	10,496	11,220
Single Chair, High Left Arm 	Boxed	YM	9	113131L	46W x 36D x 26H	6.8	3,372	3,913	4,201	4,490	4,779	5,076	5,395	5,718	6,091	6,584	7,169	7,755	8,331	8,921
	Rolled Front	YM	8	113131L	46W x 36D x 26H	6.4	3,372	3,887	4,167	4,436	4,714	4,993	5,304	5,603	5,964	6,434	6,989	7,552	8,099	8,650
Single Chair, High Right Arm 	Boxed	YM	9	113131R	46W x 36D x 26H	6.8	3,372	3,913	4,201	4,490	4,779	5,076	5,395	5,718	6,091	6,584	7,169	7,755	8,331	8,921
	Rolled Front	YM	8	113131R	46W x 36D x 26H	6.4	3,372	3,887	4,167	4,436	4,714	4,993	5,304	5,603	5,964	6,434	6,989	7,552	8,099	8,650

To Order Select Below

1. Series/Style

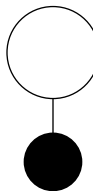

YM9

**Yoom
Boxed**

YM8

**Yoom
Rolled Front**

2. Unit

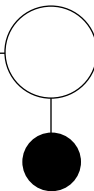

Unit

113100 SINGLE CHAIR, ARMLESS

113131P SINGLE CHAIR, HIGH BOTH ARMS

113131L SINGLE CHAIR, HIGH LEFT ARM

113131R SINGLE CHAIR, HIGH RIGHT ARM

3. Seam Options

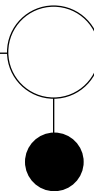

Seam Options

SS SINGLE SEAM ON ALL EDGES

SP PINCH SEAM ON TOP EDGES
SINGLE SEAM ON SIDE EDGES

SW STANDARD WELT CORD ON ALL EDGES **+10% OF COM LIST**

4. Glides/Casters/Legs

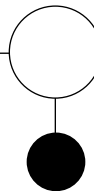

Glides

PG PLASTIC GLIDE

FG FELT GLIDE

RG RUBBER GLIDE

Glide Recommendations

For easier movement, order Plastic Glides for carpet, Felt Glides for hard floors and Rubber Glides for static positioning.

5. Power

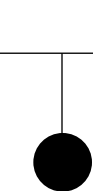

Casters

CH HARD WHEEL CASTER **+89**

CS SOFT WHEEL CASTER **+89**

Recommended for mobility in collaborative settings.

Legs

L1 ROUND METAL LEGS **+156**

Round Legs increase seating height by 2". Round Legs are available in standard Stylex powder coated painted metal finishes and Polished Aluminum.

6. Options

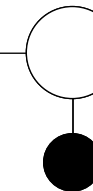

Options

G GANGING

7. Upholstery

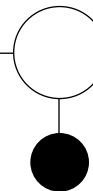

Upholstery

See [general information section](#) for details on textile program and COM/COL information.

Yoom Rolled textiles must be cut up the roll. Yoom is designed to have a casual look and feel. It is meant to show wrinkling with most fabrics.

To specify leather, use Yoom Soft found on [page 30](#).

Yoom

PRE-CONFIGURED: SINGLE CHAIR

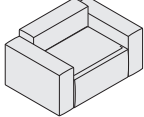
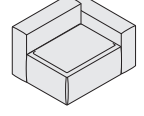
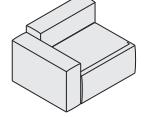
TITLE	SERIES	STYLE	UNIT	DIMENSIONS	YDG	Textile Upholstery Grades														
						COM	A	B	C	D	E	F	G	H	I	J	K	L	M	
Single Chair, Low Both Arms 	Boxed	YM	9	113151P	56W x 36D x 26H	8.3	3,973	4,634	4,987	5,336	5,693	6,052	6,443	6,842	7,299	7,900	8,615	9,330	10,032	10,752
	Rolled Front	YM	8	113151P	56W x 36D x 26H	8	3,973	4,616	4,965	5,301	5,650	5,997	6,383	6,766	7,214	7,799	8,495	9,195	9,876	10,572
Single Chair, Low Left Arm 	Boxed	YM	9	113151L	46W x 36D x 26H	6.4	3,223	3,738	4,013	4,286	4,563	4,844	5,148	5,458	5,814	6,283	6,840	7,397	7,945	8,506
	Rolled Front	YM	8	113151L	46W x 36D x 26H	6.2	3,223	3,720	3,991	4,251	4,520	4,789	5,088	5,382	5,729	6,182	6,720	7,262	7,789	8,326
Single Chair, Low Right Arm 	Boxed	YM	9	113151R	46W x 36D x 26H	6.4	3,223	3,738	4,013	4,286	4,563	4,844	5,148	5,458	5,814	6,283	6,840	7,397	7,945	8,506
	Rolled Front	YM	8	113151R	46W x 36D x 26H	6.2	3,223	3,720	3,991	4,251	4,520	4,789	5,088	5,382	5,729	6,182	6,720	7,262	7,789	8,326

To Order Select Below

1. Series/Style

- YM9
Yoom Boxed
- YM8
Yoom Rolled Front

2. Unit

- 113151P SINGLE CHAIR, LOW BOTH ARMS
- 113151L SINGLE CHAIR, LOW LEFT ARM
- 113151R SINGLE CHAIR, LOW RIGHT ARM

3. Seam Options

- SS SINGLE SEAM ON ALL EDGES
- SP PINCH SEAM ON TOP EDGES
SINGLE SEAM ON SIDE EDGES
- SW STANDARD WELT CORD ON ALL EDGES **+10% OF COM LIST**

4. Glides/Casters/Legs

- PG PLASTIC GLIDE
 - FG FELT GLIDE
 - RG RUBBER GLIDE
- Glide Recommendations**
For easier movement, order Plastic Glides for carpet, Felt Glides for hard floors and Rubber Glides for static positioning.

5. Power

- CH HARD WHEEL CASTER **+89**
 - CS SOFT WHEEL CASTER **+89**
- Recommended for mobility in collaborative settings.
- L1 ROUND METAL LEGS **+156**
- Round Legs increase seating height by 2". Round Legs are available in standard Stylex powder coated painted metal finishes and Polished Aluminum.

6. Options

- G GANGING

7. Upholstery

- See **general information section for details on textile program and COM/COL information.**
- Yoom Rolled textiles must be cut up the roll. Yoom is designed to have a casual look and feel. It is meant to show wrinkling with most fabrics.
- To specify leather, use Yoom Soft found on [page 30](#).

Yoom

PRE-CONFIGURED: SINGLE FULL CHAIR

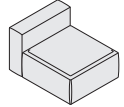
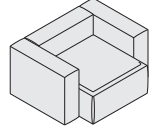
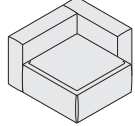
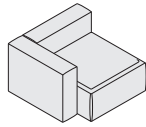
TITLE	SERIES	STYLE	UNIT	DIMENSIONS	YDG	Textile Upholstery Grades														
						COM	A	B	C	D	E	F	G	H	I	J	K	L	M	
Single Full Chair, Armless 	Boxed	YM	9	123100	36W x 45D x 26H	5.5	2,773	3,201	3,432	3,660	3,891	4,123	4,378	4,634	4,932	5,322	5,786	6,252	6,710	7,175
	Rolled Front	YM	8	123100	36W x 45D x 26H	5.3	2,773	3,193	3,420	3,641	3,869	4,095	4,347	4,595	4,890	5,273	5,726	6,184	6,634	7,084
Single Full Chair, High Both Arms 	Boxed	YM	9	123131P	56W x 45D x 26H	9.7	4,571	5,343	5,756	6,168	6,583	7,003	7,462	7,922	8,456	9,158	9,994	10,834	11,656	12,497
	Rolled Front	YM	8	123131P	56W x 45D x 26H	9.4	4,571	5,319	5,720	6,111	6,517	6,919	7,369	7,805	8,330	9,011	9,814	10,630	11,428	12,224
Single Full Chair, High Left Arm 	Boxed	YM	9	123131L	46W x 45D x 26H	7.6	3,672	4,272	4,594	4,914	5,237	5,563	5,920	6,278	6,694	7,240	7,890	8,543	9,183	9,836
	Rolled Front	YM	8	123131L	46W x 45D x 26H	7.3	3,672	4,256	4,570	4,876	5,193	5,507	5,858	6,200	6,610	7,142	7,770	8,407	9,031	9,654
Single Full Chair, High Right Arm 	Boxed	YM	9	123131R	46W x 45D x 26H	7.6	3,672	4,272	4,594	4,914	5,237	5,563	5,920	6,278	6,694	7,240	7,890	8,543	9,183	9,836
	Rolled Front	YM	8	123131R	46W x 45D x 26H	7.3	3,672	4,256	4,570	4,876	5,193	5,507	5,858	6,200	6,610	7,142	7,770	8,407	9,031	9,654

To Order Select Below

1. Series/Style

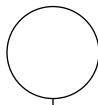
- 



 YM9
Yoom
Boxed
- 

 YM8
Yoom
Rolled Front

2. Unit

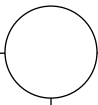
- 



Unit
 123100 SINGLE FULL CHAIR, ARMLESS
 123131P SINGLE FULL CHAIR, HIGH BOTH ARMS
 123131L SINGLE FULL CHAIR, HIGH LEFT ARM
 123131R SINGLE FULL CHAIR, HIGH RIGHT ARM

3. Seam Options

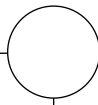
- 



Seam Options
 SS SINGLE SEAM ON ALL EDGES
 SP PINCH SEAM ON TOP EDGES
 SINGLE SEAM ON SIDE EDGES
 SW STANDARD WELT CORD ON ALL EDGES **+10% OF COM LIST**

4. Glides/Casters/Legs

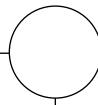
- 



Glides
 PG PLASTIC GLIDE
 FG FELT GLIDE
 RG RUBBER GLIDE

Glide Recommendations
 For easier movement, order Plastic Glides for carpet, Felt Glides for hard floors and Rubber Glides for static positioning.
- 

Casters
 CH HARD WHEEL CASTER **+89**
 CS SOFT WHEEL CASTER **+89**

 Recommended for mobility in collaborative settings.
- 

Legs
 L1 ROUND METAL LEGS **+156**

 Round Legs increase seating height by 2". Round Legs are available in standard Stylex powder coated painted metal finishes and Polished Aluminum.

5. Power

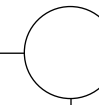
- 



Power
 Refer to power ordering steps on [page 8](#).

6. Options

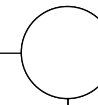
- 



Options
 G GANGING

7. Upholstery

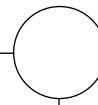
- 



Upholstery
 See [general information section](#) for details on textile program and COM/COL information.

 Yoom Rolled textiles must be cut up the roll. Yoom is designed to have a casual look and feel. It is meant to show wrinkling with most fabrics.

 To specify leather, use Yoom Soft found on [page 30](#).

Yoom

PRE-CONFIGURED: SINGLE FULL CHAIR

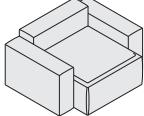
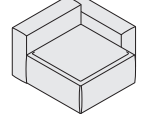
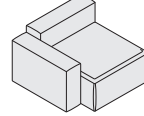
TITLE	SERIES	STYLE	UNIT	DIMENSIONS	YDG	Textile Upholstery Grades														
						COM	A	B	C	D	E	F	G	H	I	J	K	L	M	
Single Full Chair, Low Both Arms 	Boxed	YM	9	123151P	56W x 45D x 26H	9.2	4,273	4,993	5,380	5,760	6,151	6,539	6,968	7,402	7,902	8,556	9,336	10,118	10,884	11,667
	Rolled Front	YM	8	123151P	56W x 45D x 26H	8.8	4,273	4,985	5,368	5,741	6,129	6,511	6,937	7,363	7,860	8,507	9,276	10,050	10,808	11,576
Single Full Chair, Low Left Arm 	Boxed	YM	9	123151L	46W x 45D x 26H	7.3	3,523	4,097	4,406	4,710	5,021	5,331	5,673	6,018	6,417	6,939	7,561	8,185	8,797	9,421
	Rolled Front	YM	8	123151L	46W x 45D x 26H	7	3,523	4,089	4,394	4,691	4,999	5,303	5,642	5,979	6,375	6,890	7,501	8,117	8,721	9,330
Single Full Chair, Low Right Arm 	Boxed	YM	9	123151R	46W x 45D x 26H	7.3	3,523	4,097	4,406	4,710	5,021	5,331	5,673	6,018	6,417	6,939	7,561	8,185	8,797	9,421
	Rolled Front	YM	8	123151R	46W x 45D x 26H	7	3,523	4,089	4,394	4,691	4,999	5,303	5,642	5,979	6,375	6,890	7,501	8,117	8,721	9,330

To Order Select Below

1. Series/Style

- YM9
Yoom Boxed
- YM8
Yoom Rolled Front

2. Unit

- Unit
- 123151P SINGLE FULL CHAIR, LOW BOTH ARMS
- 123151L SINGLE FULL CHAIR, LOW LEFT ARM
- 123151R SINGLE FULL CHAIR, LOW RIGHT ARM

3. Seam Options

- Seam Options
- SS SINGLE SEAM ON ALL EDGES
- SP PINCH SEAM ON TOP EDGES
SINGLE SEAM ON SIDE EDGES
- SW STANDARD WELT CORD ON ALL EDGES **+10% OF COM LIST**

4. Glides/Casters/Legs

- Glides
 - PG PLASTIC GLIDE
 - FG FELT GLIDE
 - RG RUBBER GLIDE
- Glide Recommendations**
For easier movement, order Plastic Glides for carpet, Felt Glides for hard floors and Rubber Glides for static positioning.

5. Power

- Casters
 - CH HARD WHEEL CASTER **+89**
 - CS SOFT WHEEL CASTER **+89**
- Recommended for mobility in collaborative settings.
- Legs
 - L1 ROUND METAL LEGS **+156**
- Round Legs increase seating height by 2". Round Legs are available in standard Stylex powder coated painted metal finishes and Polished Aluminum.

6. Options

- Power
 - Options
 - G GANGING
- Refer to power ordering steps on [page 8](#).

7. Upholstery

- Upholstery
- See [general information section](#) for details on textile program and COM/COL information.
- Yoom Rolled textiles must be cut up the roll. Yoom is designed to have a casual look and feel. It is meant to show wrinkling with most fabrics.
- To specify leather, use Yoom Soft found on [page 30](#).

Yoom

PRE-CONFIGURED: DOUBLE CHAIR

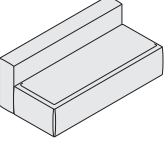
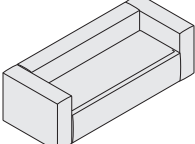
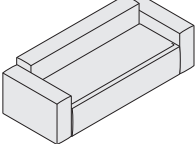
TITLE	SERIES	STYLE	UNIT	DIMENSIONS	YDG	Textile Upholstery Grades														
						COM	A	B	C	D	E	F	G	H	I	J	K	L	M	
Double Chair, Armless 	Boxed	YM	9	143400	70W x 36D x 26H	8.6	4,272	4,956	5,329	5,689	6,061	6,433	6,840	7,249	7,728	8,353	9,098	9,837	10,569	11,316
	Rolled Front	YM	8	143400	70W x 36D x 26H	8.3	4,272	4,925	5,279	5,621	5,972	6,323	6,711	7,103	7,554	8,149	8,855	9,562	10,255	10,962
Double Chair, High Both Arms 	Boxed	YM	9	143431P	90W x 36D x 26H	12.8	6,070	7,098	7,653	8,197	8,753	9,313	9,924	10,537	11,252	12,189	13,306	14,419	15,515	16,638
	Rolled Front	YM	8	143431P	90W x 36D x 26H	12.3	6,070	7,051	7,579	8,091	8,620	9,147	9,733	10,313	10,994	11,887	12,943	14,008	15,049	16,102
Double Chair, Low Both Arms 	Boxed	YM	9	143451P	90W x 36D x 26H	12.2	5,772	6,748	7,277	7,789	8,321	8,849	9,430	10,017	10,698	11,587	12,648	13,703	14,743	15,808
	Rolled Front	YM	8	143451P	90W x 36D x 26H	11.9	5,772	6,717	7,227	7,721	8,232	8,739	9,301	9,871	10,524	11,383	12,405	13,428	14,429	15,454

To Order Select Below

1. Series/Style

- Yoom Boxed**
- Yoom Rolled Front**

2. Unit

- Unit**
- 143400 DOUBLE CHAIR, ARMLESS
- 143431P DOUBLE CHAIR, HIGH BOTH ARMS
- 143451P DOUBLE CHAIR, LOW BOTH ARMS

3. Seam Options

- Seam Options**
- SS SINGLE SEAM ON ALL EDGES
- SP PINCH SEAM ON TOP EDGES
SINGLE SEAM ON SIDE EDGES
- SW STANDARD WELT CORD ON ALL EDGES **+10% OF COM LIST**

4. Glides/Casters/Legs

- Glides**
- PG PLASTIC GLIDE
- FG FELT GLIDE
- RG RUBBER GLIDE
- Glide Recommendations**
For easier movement, order Plastic Glides for carpet, Felt Glides for hard floors and Rubber Glides for static positioning.
- Legs**
- L1 ROUND METAL LEGS **+156**
- Round Legs increase seating height by 2". Round Legs are available in standard Stylex powder coated painted metal finishes and Polished Aluminum.

5. Power

- Power**
- Refer to power ordering steps on [page 8](#).

6. Options

- Options**
- G GANGING

7. Upholstery

- Upholstery**
- See [general information section](#) for details on textile program and COM/COL information.
- Yoom Rolled textiles must be cut up the roll. Yoom is designed to have a casual look and feel. It is meant to show wrinkling with most fabrics.
- To specify leather, use Yoom Soft found on [page 30](#).

Yoom

PRE-CONFIGURED: DOUBLE FULL CHAIR

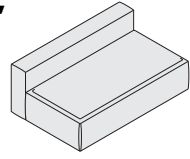
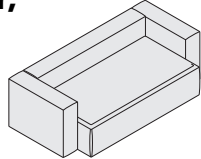
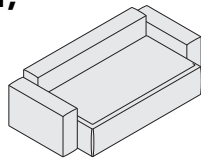
TITLE	SERIES	STYLE	UNIT	DIMENSIONS	YDG	Textile Upholstery Grades														
						COM	A	B	C	D	E	F	G	H	I	J	K	L	M	
Double Full Chair, Armless 	Boxed	YM	9	153400	70W x 45D x 26H	8.6	4,871	5,643	6,061	6,466	6,885	7,305	7,762	8,221	8,761	9,461	10,300	11,135	11,956	12,794
	Rolled Front	YM	8	153400	70W x 45D x 26H	9.4	4,871	5,524	5,878	6,219	6,572	6,924	7,311	7,702	8,154	8,749	9,454	10,162	10,856	11,563
Double Full Chair, High Both Arms 	Boxed	YM	9	153431P	90W x 45D x 26H	12.9	6,669	7,785	8,385	8,974	9,577	10,185	10,846	11,509	12,285	13,297	14,508	15,717	16,902	18,116
	Rolled Front	YM	8	153431P	90W x 45D x 26H	13.5	6,669	7,650	8,178	8,689	9,220	9,748	10,333	10,912	11,594	12,487	13,542	14,608	15,650	16,703
Double Full Chair, Low Both Arms 	Boxed	YM	9	153451P	90W x 45D x 26H	12.4	6,371	7,435	8,009	8,566	9,145	9,721	10,352	10,989	11,731	12,695	13,850	15,001	16,130	17,286
	Rolled Front	YM	8	153451P	90W x 45D x 26H	13	6,371	7,316	7,826	8,319	8,832	9,340	9,901	10,470	11,124	11,983	13,004	14,028	15,030	16,055

To Order Select Below

1. Series/Style

- YM9
Yoom Boxed
- YM8
Yoom Rolled Front

2. Unit

- 153400 DOUBLE FULL CHAIR, ARMLESS
- 153431P DOUBLE FULL CHAIR, HIGH BOTH ARMS
- 153451P DOUBLE FULL CHAIR, LOW BOTH ARMS

3. Seam Options

- SS SINGLE SEAM ON ALL EDGES
- SP PINCH SEAM ON TOP EDGES
SINGLE SEAM ON SIDE EDGES
- SW STANDARD WELT CORD ON ALL EDGES **+10% OF COM LIST**

4. Glides/Casters/Legs

- PG PLASTIC GLIDE
 - FG FELT GLIDE
 - RG RUBBER GLIDE
- Glide Recommendations**
For easier movement, order Plastic Glides for carpet, Felt Glides for hard floors and Rubber Glides for static positioning.
- L1 ROUND METAL LEGS **+156**
- Round Legs increase seating height by 2". Round Legs are available in standard Stylex powder coated painted metal finishes and Polished Aluminum.

5. Power

- Power
Refer to power ordering steps on [page 8](#).

6. Options

- G GANGING

7. Upholstery

- Upholstery
See [general information section](#) for details on textile program and COM/COL information.
- Yoom Rolled textiles must be cut up the roll. Yoom is designed to have a casual look and feel. It is meant to show wrinkling with most fabrics.
- To specify leather, use Yoom Soft found on [page 30](#).

Yoom

PRE-CONFIGURED: CHAISE, CORNER, & SINGLE NARROW

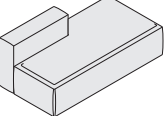
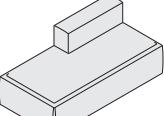
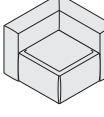
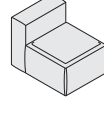
TITLE	SERIES	STYLE	UNIT	DIMENSIONS	Textile Upholstery Grades															
					YDG	COM	A	B	C	D	E	F	G	H	I	J	K	L	M	
Chaise Right w/Back 	Boxed	YM	9	1631	70W x 36D x 26H	7.4	4,121	4,697	5,006	5,309	5,621	5,933	6,273	6,617	7,016	7,540	8,160	8,785	9,396	10,022
	Rolled Front	YM	8	1631	70W x 36D x 26H	7.2	4,121	4,679	4,980	5,272	5,575	5,877	6,211	6,539	6,931	7,439	8,041	8,647	9,242	9,842
Chaise Left w/Back 	Boxed	YM	9	1731	70W x 36D x 26H	7.4	4,121	4,697	5,006	5,309	5,621	5,933	6,273	6,617	7,016	7,540	8,160	8,785	9,396	10,022
	Rolled Front	YM	8	1731	70W x 36D x 26H	7.2	4,121	4,679	4,980	5,272	5,575	5,877	6,211	6,539	6,931	7,439	8,041	8,647	9,242	9,842
Corner Chair 	Boxed	YM	9	1337	36W x 36D x 26H	5	2,624	3,027	3,246	3,457	3,677	3,895	4,135	4,373	4,655	5,021	5,457	5,896	6,324	6,760
Single Narrow Chair 	Boxed	YM	9	1333	27W x 36D x 26H	3.3	2,100	2,356	2,496	2,631	2,771	2,912	3,063	3,216	3,396	3,631	3,908	4,188	4,464	4,740
	Rolled Front	YM	8	1333	27W x 36D x 26H	4	2,100	2,418	2,586	2,753	2,925	3,097	3,288	3,475	3,696	3,989	4,329	4,674	5,014	5,356

To Order Select Below

1. Series/Style

YM9	Yoom Boxed
YM8	Yoom Rolled Front

2. Unit

Unit
1631 CHAISE RIGHT W/BACK
1731 CHAISE LEFT W/BACK
1337 CORNER CHAIR
1333 SINGLE NARROW CHAIR

For a rolled front corner chair, modular pieces **YM913** (boxed single narrow seat) and **YM837** (rolled front corner back) should be used together.

3. Seam Options

Seam Options	
SS	SINGLE SEAM ON ALL EDGES
SP	PINCH SEAM ON TOP EDGES SINGLE SEAM ON SIDE EDGES
SW	STANDARD WELT CORD ON ALL EDGES

+10% OF COM LIST

4. Glides/Casters/Legs

Glides
PG PLASTIC GLIDE
FG FELT GLIDE
RG RUBBER GLIDE

Glide Recommendations
For easier movement, order Plastic Glides for carpet, Felt Glides for hard floors and Rubber Glides for static positioning.

5. Power

Casters	
CH	HARD WHEEL CASTER +89
CS	SOFT WHEEL CASTER +89

Not available on chaise. Recommended for mobility in collaborative settings.

Legs	
L1	ROUND METAL LEGS +156

Round Legs increase seating height by 2". Round Legs are available in standard Stylex powder coated painted metal finishes and Polished Aluminum.

6. Options

Options
G GANGING

7. Upholstery



See general information section for details on textile program and COM/COL information.

Yoom Rolled textiles must be cut up the roll. Yoom is designed to have a casual look and feel. It is meant to show wrinkling with most fabrics.

To specify leather, use Yoom Soft found on [page 30](#).

Yoom Soft

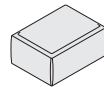
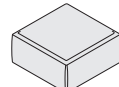
MODULAR: SEATS

TITLE	SERIES	STYLE	UNIT	DIMENSIONS	COM	COL	Textile Upholstery Grades										Leather Upholstery Grades									
							YDG	SQFT	COM	A	B	C	D	E	F	G	H	I	J	K	L	M	W	X	Y	E1
Single Seat 	Boxed	YM	6	11	36.25W x 27.25D x 15H	2.5	36	1,757	1,957	2,065	2,170	2,281	2,387	2,507	2,627	2,768	2,952	3,170	3,385	3,603	3,818	2,767	3,029	3,879	4,230	5,188
	Rolled Front	YM	5	11	36.25W x 27.25D x 15H	2.5	40	1,757	1,947	2,053	2,154	2,258	2,361	2,477	2,591	2,724	2,898	3,106	3,316	3,520	3,728	2,942	3,250	4,244	4,661	5,786
Single Full Seat 	Boxed	YM	6	12	36.25W x 36.25D x 15H	3.3	43	2,216	2,477	2,618	2,754	2,897	3,039	3,194	3,351	3,533	3,772	4,056	4,341	4,620	4,904	3,441	3,762	4,792	5,222	6,385
	Rolled Front	YM	5	12	36.25W x 36.25D x 15H	3.3	48	2,216	2,477	2,618	2,754	2,897	3,039	3,194	3,351	3,533	3,772	4,056	4,341	4,620	4,904	3,630	3,998	5,186	5,679	7,019
Single Narrow Seat 	Boxed	YM	6	13	36.25W x 36.25D x 15H	1.7	29	1,450	1,582	1,651	1,721	1,791	1,863	1,941	2,018	2,111	2,229	2,371	2,515	2,654	2,796	2,273	2,491	3,179	3,469	4,250
	Rolled Front	YM	5	13	36.25W x 27.25D x 15H	2	32	1,450	1,607	1,693	1,775	1,860	1,945	2,040	2,132	2,243	2,385	2,556	2,727	2,895	3,065	2,368	2,624	3,407	3,734	4,618

To Order Select Below

1. Series/Style

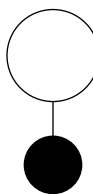

YM6

**Yoom Soft
Boxed**

YM5

**Yoom Soft
Rolled Front**

2. Unit

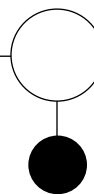

Unit

11 SINGLE SEAT

12 SINGLE FULL SEAT

13 SINGLE NARROW SEAT

3. Seam Options

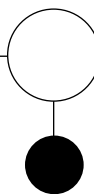

Seam Options

SS SINGLE SEAM ON ALL EDGES

SP PINCH SEAM ON TOP EDGES
SINGLE SEAM ON SIDE EDGES

SW STANDARD WELT CORD
ON ALL EDGES **+10% OF
COM LIST**

4. Glides/Casters/Legs

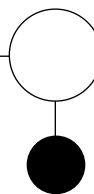

Glides

PG PLASTIC GLIDE

FG FELT GLIDE

RG RUBBER GLIDE

Glide Recommendations
For easier movement, order Plastic
Glides for carpet, Felt Glides for hard
floors and Rubber Glides for static
positioning.

Casters

CH HARD WHEEL CASTER **+89**

CS SOFT WHEEL CASTER **+89**

Recommended for mobility in
collaborative settings.

Legs

L1 ROUND METAL LEGS **+156**

Round Legs increase seating height by 2".
Round Legs are available in standard Stylex
powder coated painted metal finishes and
Polished Aluminum.

5. Power

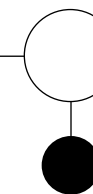

Power

Refer to power
ordering steps
on [page 8](#).

6. Options

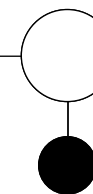

Options

G GANGING

7. Upholstery

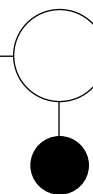

Upholstery

See [general information
section for details on textile
program and COM/COL
information.](#)

Yoom Rolled textiles must be cut up
the roll. Yoom is designed to have a
casual look and feel. It is meant to
show wrinkling with most fabrics.

Yoom Soft

MODULAR: SEATS

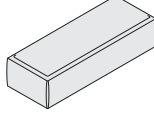
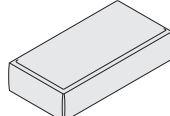
TITLE	SERIES	STYLE	UNIT	DIMENSIONS	COM	COL	Textile Upholstery Grades										Leather Upholstery Grades									
							YDG	SQFT	COM	A	B	C	D	E	F	G	H	I	J	K	L	M	W	X	Y	E1
Double Seat 	Boxed	YM	6	14	70.25W x 27.25D x 15H	4.54	61	2,979	3,327	3,515	3,699	3,888	4,078	4,286	4,493	4,738	5,055	5,434	5,813	6,185	6,565	4,704	5,153	6,601	7,206	8,842
	Rolled Front	YM	5	14	70.25W x 27.25D x 15H	4.4	67	2,979	3,317	3,502	3,681	3,866	4,051	4,254	4,455	4,692	5,003	5,373	5,741	6,107	6,474	4,961	5,480	7,147	7,842	9,722
	Rolled Side	YM	4	14	70.25W x 27.25D x 15H	5.5	67	2,979	3,415	3,651	3,880	4,116	4,352	4,612	4,873	5,178	5,574	6,048	6,522	6,988	7,460	4,961	5,480	7,147	7,842	9,722
Double Full Seat 	Boxed	YM	6	15	70.25W x 36.25D x 15H	5.5	72	3,894	4,329	4,565	4,794	5,034	5,269	5,528	5,788	6,094	6,491	6,964	7,437	7,905	8,378	5,925	6,455	8,165	8,876	10,800
	Rolled Front	YM	5	15	70.25W x 36.25D x 15H	5.5	79	3,894	4,321	4,553	4,776	5,009	5,242	5,498	5,752	6,049	6,439	6,903	7,367	7,824	8,287	6,234	6,844	8,811	9,630	11,848
	Rolled Side	YM	4	15	70.25W x 36.25D x 15H	5.5	79	3,894	4,329	4,565	4,794	5,034	5,269	5,528	5,788	6,094	6,491	6,964	7,437	7,905	8,378	6,234	6,844	8,811	9,630	11,848

To Order Select Below

1. Series/Style

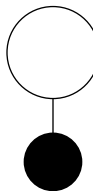

YM6

**Yoom Soft
Boxed**

YM5

**Yoom Soft
Rolled Front**

YM4

**Yoom Soft
Rolled Side**

2. Unit

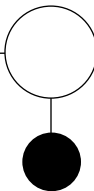

Unit

14 DOUBLE SEAT

15 DOUBLE FULL SEAT

3. Seam Options

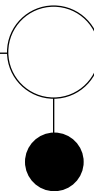

Seam Options

SS SINGLE SEAM ON ALL EDGES

SP PINCH SEAM ON TOP EDGES
SINGLE SEAM ON SIDE EDGES

SW STANDARD WELT CORD
ON ALL EDGES **+10% OF
COM LIST**

4. Glides/Casters/Legs

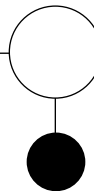

Glides

PG PLASTIC GLIDE

FG FELT GLIDE

RG RUBBER GLIDE

Glide Recommendations
For easier movement, order Plastic
Glides for carpet, Felt Glides for hard
floors and Rubber Glides for static
positioning.

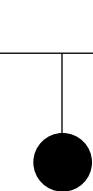

Legs

L1 ROUND METAL LEGS **+156**

Round Legs increase seating height by 2".
Round Legs are available in standard Stylex
powder coated painted metal finishes and
Polished Aluminum.

5. Power

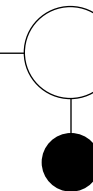

Power

**Refer to power
ordering steps
on page 8.**

6. Options

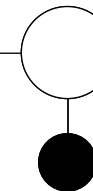

Options

G GANGING

7. Upholstery

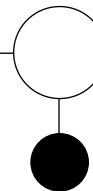

Upholstery

**See general information
section for details on textile
program and COM/COL
information.**

Yoom Rolled textiles must be cut up
the roll. Yoom is designed to have a
casual look and feel. It is meant to
show wrinkling with most fabrics.

See **page 9** for more information
on rolled side specification.

Yoom Soft

MODULAR: SEATS

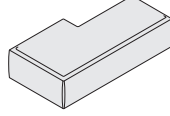
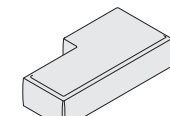
TITLE	SERIES	STYLE	UNIT	DIMENSIONS	COM	COL	Textile Upholstery Grades										Leather Upholstery Grades									
							YDG	SQFT	COM	A	B	C	D	E	F	G	H	I	J	K	L	M	W	X	Y	E1
Chaise Right 	Boxed	YM	6	16	70.25W x 36.25/27.25D x 15H	5.2	64	3,894	4,304	4,527	4,743	4,964	5,187	5,431	5,675	5,963	6,336	6,780	7,225	7,664	8,108	5,708	6,178	7,700	8,334	10,052
	Rolled Front	YM	5	16	70.25W x 36.25/27.25D x 15H	5	70	3,894	4,295	4,513	4,723	4,942	5,160	5,397	5,637	5,920	6,283	6,718	7,153	7,584	8,019	5,963	6,502	8,240	8,964	10,924
	Rolled Side	YM	4	16	70.25W x 36.25/27.25D x 15H	5.5	70	3,894	4,329	4,565	4,794	5,034	5,269	5,528	5,788	6,094	6,491	6,964	7,437	7,905	8,378	5,963	6,502	8,240	8,964	10,924
Chaise Left 	Boxed	YM	6	17	70.25W x 36.25/27.25D x 15H	5.2	64	3,894	4,304	4,527	4,743	4,964	5,187	5,431	5,675	5,963	6,336	6,780	7,225	7,664	8,108	5,708	6,178	7,700	8,334	10,052
	Rolled Front	YM	5	17	70.25W x 36.25/27.25D x 15H	5	70	3,894	4,295	4,513	4,723	4,942	5,160	5,397	5,637	5,920	6,283	6,718	7,153	7,584	8,019	5,963	6,502	8,240	8,964	10,924
	Rolled Side	YM	4	17	70.25W x 36.25/27.25D x 15H	5.5	70	3,894	4,329	4,565	4,794	5,034	5,269	5,528	5,788	6,094	6,491	6,964	7,437	7,905	8,378	5,963	6,502	8,240	8,964	10,924

To Order Select Below

1. Series/Style

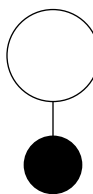

YM6

**Yoom Soft
Boxed**

YM5

**Yoom Soft
Rolled Front**

YM4

**Yoom Soft
Rolled Side**

2. Unit

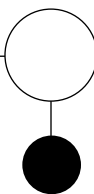

Unit

16 CHAISE RIGHT SEAT

17 CHAISE LEFT SEAT

3. Seam Options

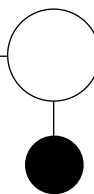

Seam Options

SS SINGLE SEAM ON ALL EDGES

SP PINCH SEAM ON TOP EDGES
SINGLE SEAM ON SIDE EDGES

SW STANDARD WELT CORD
ON ALL EDGES **+10% OF
COM LIST**

4. Glides/Casters/Legs

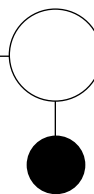

Glides

PG PLASTIC GLIDE

FG FELT GLIDE

RG RUBBER GLIDE

Glide Recommendations
For easier movement, order Plastic
Glides for carpet, Felt Glides for hard
floors and Rubber Glides for static
positioning.

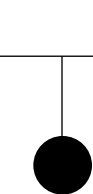

Legs

L1 ROUND METAL LEGS **+156**

Round Legs increase seating height by 2".
Round Legs are available in standard Stylex
powder coated painted metal finishes and
Polished Aluminum.

5. Power

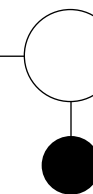

Power

**Refer to power
ordering steps
on page 8.**

6. Options

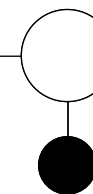

Options

G GANGING

7. Upholstery

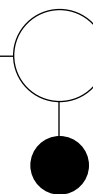

Upholstery

**See general information
section for details on textile
program and COM/COL
information.**

Yoom Rolled textiles must be cut up
the roll. Yoom is designed to have a
casual look and feel. It is meant to
show wrinkling with most fabrics.

See **page 9** for more information
on rolled side specification.

Yoom Soft

MODULAR: BACKS

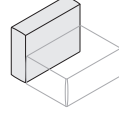
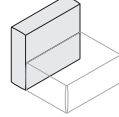
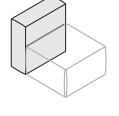
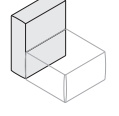
TITLE	SERIES	STYLE	UNIT	DIMENSIONS	COM	COL	Textile Upholstery Grades										Leather Upholstery Grades									
							YDG	SQFT	COM	A	B	COL	C	D	E	F	G	H	I	J	K	L	M	W	X	Y
Single Back/ Single Arm High 	Boxed	YM	6	31	36.25W x 9D x 26H	2.2	29	1,147	1,319	1,414	1,507	1,600	1,696	1,800	1,904	2,025	2,183	2,373	2,564	2,749	2,938	1,980	2,196	2,892	3,186	3,973
	Rolled Front	YM	5	31	36.25W x 9D x 26H	2.1	33	1,147	1,310	1,402	1,487	1,576	1,668	1,767	1,866	1,982	2,132	2,311	2,493	2,669	2,849	2,109	2,359	3,170	3,507	4,419
Single High Back 	Boxed	YM	6	32	36.25W x 9D x 30H	2.5	34	1,260	1,450	1,556	1,658	1,760	1,866	1,981	2,094	2,228	2,403	2,610	2,820	3,023	3,232	2,211	2,458	3,257	3,590	4,491
	Rolled Front	YM	5	32	36.25W x 9D x 30H	2.3	37	1,260	1,444	1,544	1,639	1,738	1,836	1,945	2,057	2,183	2,352	2,548	2,748	2,944	3,144	2,350	2,633	3,546	3,928	4,960
Single Narrow Back 	Boxed	YM	6	33	27.25W x 9D x 26H	1.7	24	1,069	1,201	1,272	1,339	1,411	1,483	1,559	1,638	1,729	1,848	1,990	2,132	2,272	2,414	1,735	1,908	2,468	2,702	3,331
	Rolled Front	YM	5	33	27.25W x 9D x 26H	2.1	26	1,069	1,234	1,324	1,411	1,500	1,592	1,692	1,787	1,905	2,057	2,235	2,415	2,594	2,773	1,829	2,028	2,664	2,931	3,649
Single Narrow High Back 	Boxed	YM	6	38	27.25W x 9D x 30H	1.9	23	1,236	1,372	1,448	1,520	1,594	1,670	1,749	1,832	1,929	2,054	2,200	2,350	2,496	2,645	2,179	2,424	3,217	3,545	4,438
	Rolled Front	YM	5	38	27.25W x 9D x 30H	1.8	23	1,236	1,372	1,448	1,520	1,594	1,670	1,749	1,832	1,929	2,054	2,200	2,350	2,496	2,645	2,179	2,424	3,217	3,545	4,438

To Order Select Below

1. Series/Style

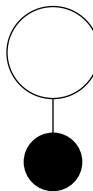

YM6

**Yoom Soft
Boxed**

YM5

**YoomSoft
Rolled Front**

2. Unit

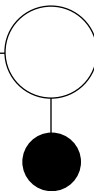

Unit

31 SINGLE BACK/SINGLE ARM HIGH

32 SINGLE HIGH BACK

33 SINGLE NARROW BACK

38 SINGLE NARROW HIGH BACK

3. Seam Options

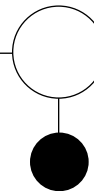

Seam Options

SS SINGLE SEAM ON ALL EDGES

PINCH SEAM ON TOP EDGES
SP SINGLE SEAM ON SIDE EDGES

SW STANDARD WELT CORD ON ALL EDGES **+10% OF COM LIST**

4. Upholstery

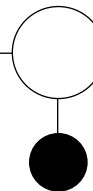

Upholstery

See general information section for details on textile program and COM/COL information.

Yoom Rolled textiles must be cut up the roll. Yoom is designed to have a casual look and feel. It is meant to show wrinkling with most fabrics.

Yoom Soft

MODULAR: BACKS

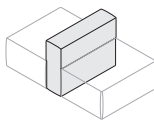
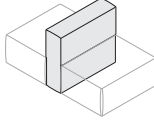
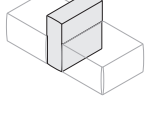
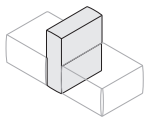
TITLE	SERIES	STYLE	UNIT	DIMENSIONS	COM	COL	Textile Upholstery Grades										Leather Upholstery Grades									
							YDG	SQFT	COM	A	B	C	D	E	F	G	H	I	J	K	L	M	W	X	Y	E1
Single Thin Back to Back 	Boxed	YM	6	39	36.25W x 9D x 26H	2.1	22	1,275	1,436	1,525	1,612	1,699	1,786	1,885	1,982	2,096	2,244	2,420	2,597	2,772	2,945	2,363	2,646	3,562	3,941	4,974
	Rolled Front	YM	5	39	36.25W x 9D x 26H	2.1	22	1,275	1,436	1,525	1,612	1,699	1,786	1,885	1,982	2,096	2,244	2,420	2,597	2,772	2,945	2,363	2,646	3,562	3,941	4,974
Single Thin Back to Back High 	Boxed	YM	6	40	36.25W x 9D x 30H	2.2	24	1,424	1,596	1,687	1,780	1,871	1,966	2,066	2,169	2,287	2,443	2,630	2,817	3,001	3,186	2,514	2,796	3,712	4,092	5,123
	Rolled Front	YM	5	40	36.25W x 9D x 30H	2.2	24	1,424	1,596	1,687	1,780	1,871	1,966	2,066	2,169	2,287	2,443	2,630	2,817	3,001	3,186	2,514	2,796	3,712	4,092	5,123
Single Thin Back to Back Narrow 	Boxed	YM	6	41	27.25W x 9D x 26H	1.6	18	1,275	1,393	1,460	1,521	1,589	1,651	1,725	1,797	1,880	1,988	2,120	2,249	2,378	2,507	2,363	2,646	3,562	3,941	4,974
	Rolled Front	YM	5	41	27.25W x 9D x 26H	1.6	18	1,275	1,393	1,460	1,521	1,589	1,651	1,725	1,797	1,880	1,988	2,120	2,249	2,378	2,507	2,363	2,646	3,562	3,941	4,974
Single Thin Back to Back Narrow High 	Boxed	YM	6	42	27.25W x 9D x 30H	1.8	23	1,424	1,560	1,635	1,707	1,782	1,856	1,937	2,019	2,116	2,242	2,387	2,537	2,683	2,832	2,514	2,796	3,712	4,092	5,123
	Rolled Front	YM	5	42	27.25W x 9D x 30H	1.8	23	1,424	1,560	1,635	1,707	1,782	1,856	1,937	2,019	2,116	2,242	2,387	2,537	2,683	2,832	2,514	2,796	3,712	4,092	5,123

To Order Select Below

1. Series/Style

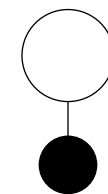

YM6

Yoom Soft Boxed

YM5

Yoom Soft Rolled Front

2. Unit

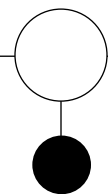

Unit

39 SINGLE THIN BACK TO BACK

40 SINGLE THIN BACK TO BACK HIGH

41 SINGLE THIN BACK TO BACK NARROW

42 SINGLE THIN BACK TO BACK NARROW HIGH

3. Seam Options

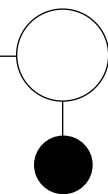

Seam Options

SS SINGLE SEAM ON ALL EDGES

SP PINCH SEAM ON TOP EDGES
SINGLE SEAM ON SIDE EDGES

SW STANDARD WELT CORD ON ALL EDGES **+10% OF COM LIST**

4. Upholstery

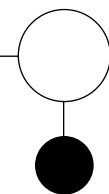

Upholstery

See general information section for details on textile program and COM/COL information.

Yoom Rolled textiles must be cut up the roll. Yoom is designed to have a casual look and feel. It is meant to show wrinkling with most fabrics.

Yoom Soft

MODULAR: BACKS

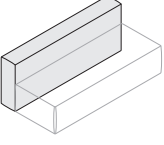
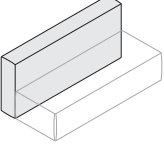
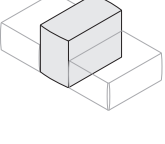
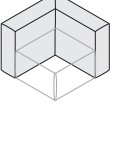
TITLE	SERIES	STYLE	UNIT	DIMENSIONS	COM	COL	Textile Upholstery Grades										Leather Upholstery Grades									
							YDG	SQFT	COM	A	B	C	D	E	F	G	H	I	J	K	L	M	W	X	Y	E1
Double Back 	Boxed	YM	6	34	70.25W x 9D x 26H	4.4	53	2,138	2,485	2,676	2,859	3,048	3,238	3,446	3,653	3,897	4,215	4,594	4,974	5,346	5,725	3,619	4,007	5,254	5,772	7,179
	Rolled Front	YM	5	34	70.25W x 9D x 36H	4.1	57	2,138	2,460	2,637	2,806	2,980	3,155	3,347	3,541	3,767	4,058	4,410	4,762	5,105	5,455	3,831	4,275	5,695	6,288	7,893
Double High Back 	Boxed	YM	6	35	70.25W x 9D x 30H	4.8	60	2,407	2,779	2,982	3,178	3,384	3,588	3,813	4,032	4,296	4,638	5,046	5,453	5,853	6,261	4,101	4,542	5,969	6,563	8,169
	Rolled Front	YM	5	35	70.25W x 9D x 30H	4.7	65	2,407	2,770	2,970	3,164	3,360	3,560	3,777	3,998	4,254	4,586	4,981	5,381	5,772	6,171	4,332	4,835	6,453	7,127	8,954
Single Back to Back 	Boxed	YM	6	36	36.25W x 18D x 26H	3.3	35	1,450	1,712	1,854	1,991	2,133	2,274	2,432	2,586	2,770	3,008	3,293	3,577	3,857	4,140	2,439	2,696	3,526	3,871	4,809
	Rolled Front	YM	5	36	36.25W x 18D x 26H	3.2	38	1,450	1,704	1,842	1,972	2,111	2,248	2,399	2,548	2,727	2,958	3,232	3,507	3,776	4,051	2,561	2,849	3,780	4,167	5,219
Corner Back 	Boxed	YM	6	37	36.25W x 36.25D x 26H	3.5	45	1,832	2,111	2,263	2,410	2,562	2,713	2,879	3,045	3,241	3,493	3,797	4,101	4,398	4,701	3,114	3,447	4,522	4,973	6,183
	Rolled Front	YM	5	37	36.25W x 36.25D x 26H	0.3	50	1,832	2,103	2,249	2,392	2,539	2,685	2,846	3,007	3,195	3,442	3,737	4,029	4,320	4,612	3,301	3,683	4,916	5,431	6,822

To Order Select Below

1. Series/Style

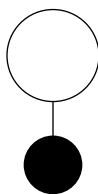

YM6

**Yoom Soft
Boxed**

YM5

**Yoom Soft
Rolled Front**

2. Unit

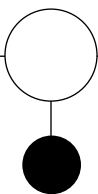

Unit

34 DOUBLE BACK

35 DOUBLE HIGH BACK

36 SINGLE BACK TO BACK

37 CORNER BACK

3. Seam Options

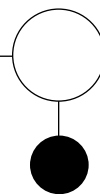

Seam Options

SS SINGLE SEAM ON ALL EDGES

SP PINCH SEAM ON TOP EDGES
SINGLE SEAM ON SIDE EDGES

SW STANDARD WELT CORD ON ALL EDGES **+10% OF COM LIST**

4. Upholstery

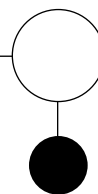

Upholstery

See general information section for details on textile program and COM/COL information.

Yoom Rolled textiles must be cut up the roll. Yoom is designed to have a casual look and feel. It is meant to show wrinkling with most fabrics.

Yoom Soft

MODULAR: ARMS

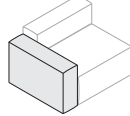
TITLE	SERIES	STYLE	UNIT	DIMENSIONS	COM		Textile Upholstery Grades										Leather Upholstery Grades									
					YDG	COL	COM	A	B	C	D	E	F	G	H	I	J	K	L	M	W	X	Y	E1	E2	
Arm Single Low 	Boxed	YM	6	51	36.25W x 10.375D x 22H	1.9	30	954	1,103	1,184	1,262	1,342	1,421	1,511	1,599	1,704	1,836	1,997	2,158	2,319	2,479	1,788	2,008	2,707	3,003	3,791
	Rolled Front	YM	5	51	36.25W x 10.375D x 22H	1.9	30	954	1,103	1,184	1,262	1,342	1,421	1,511	1,599	1,704	1,836	1,997	2,158	2,319	2,479	1,913	2,166	2,970	3,306	4,215

To Order Select Below

1. Series/Style

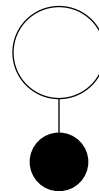

YM6

**Yoom Soft
Boxed**

YM5

**Yoom Soft
Rolled Front**

2. Unit

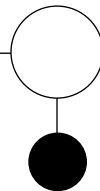

Unit

51 SINGLE ARM LOW

For Modular Single High Arm, refer to Single Back/Single Arm style on [Page 33](#).

3. Seam Options

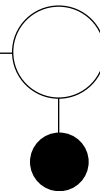

Seam Options

SS SINGLE SEAM ON ALL EDGES

SP PINCH SEAM ON TOP EDGES
SINGLE SEAM ON SIDE EDGES

SW STANDARD WELT CORD ON ALL EDGES **+10% OF COM LIST**

4. Upholstery

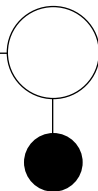

Upholstery

See general information section for details on textile program and COM/COL information.

Yoom Rolled textiles must be cut up the roll. Yoom is designed to have a casual look and feel. It is meant to show wrinkling with most fabrics.

Yoom Soft

PRE-CONFIGURED: SINGLE CHAIR

TITLE	SERIES	STYLE	UNIT	DIMENSIONS	COM	COL	Textile Upholstery Grades														Leather Upholstery Grades					
							YDG	SQFT	COM	A	B	COL	C	D	E	F	G	H	I	J	K	L	M	W	X	Y
Single Chair, Armless	Boxed	YM	6	113100	36.25W x 36.25D x 26H	4.5	65	2,904	3,276	3,479	3,677	3,881	4,083	4,307	4,531	4,793	5,135	5,543	5,949	6,352	6,756	4,747	5,225	6,771	7,416	9,161
Single Chair, High Both Arms	Boxed	YM	6	113131P	55.25W x 36.25D x 26H	8.8	124	5,198	5,914	6,307	6,691	7,081	7,475	7,907	8,339	8,843	9,501	10,289	11,077	11,850	12,632	8,707	9,617	12,555	13,788	17,107
Single Chair, High Left Arm	Boxed	YM	6	113131L	45.75W x 36D x 26H	7.6	95	4,051	4,595	4,893	5,184	5,481	5,779	6,107	6,435	6,818	7,318	7,916	8,513	9,101	9,694	6,727	7,421	9,663	10,602	13,134
Single Chair, High Right Arm	Boxed	YM	6	113131R	45.75W x 36.25D x 26H	7.6	95	4,051	4,595	4,893	5,184	5,481	5,779	6,107	6,435	6,818	7,318	7,916	8,513	9,101	9,694	6,727	7,421	9,663	10,602	13,134

To Order Select Below

1. Series/Style

- YM6
Yoom Soft Boxed
- YM5
Yoom Soft Rolled Front

2. Unit

- 113100 SINGLE CHAIR, ARMLESS
- 113131P SINGLE CHAIR, HIGH BOTH ARMS
- 113131L SINGLE CHAIR, HIGH LEFT ARM
- 113131R SINGLE CHAIR, HIGH RIGHT ARM

3. Seam Options

- SS SINGLE SEAM ON ALL EDGES
- SP PINCH SEAM ON TOP EDGES
SINGLE SEAM ON SIDE EDGES
- SW STANDARD WELT CORD ON ALL EDGES **+10% OF COM LIST**

4. Glides/Casters/Legs

- Glides**
 - PG PLASTIC GLIDE
 - FG FELT GLIDE
 - RG RUBBER GLIDE

Glide Recommendations
For easier movement, order Plastic Glides for carpet, Felt Glides for hard floors and Rubber Glides for static positioning.
- Casters**
 - CH HARD WHEEL CASTER **+89**
 - CS SOFT WHEEL CASTER **+89**

Recommended for mobility in collaborative settings.
- Legs**
 - L1 ROUND METAL LEGS **+156**

Round Legs increase seating height by 2". Round Legs are available in standard Stylex powder coated painted metal finishes and Polished Aluminum.

5. Power

- Power**
Refer to power ordering steps on page 8.

6. Options

- Options**
 - G GANGING

7. Upholstery

- Upholstery**
See general information section for details on textile program and COM/COL information.
- Yoom Rolled textiles must be cut up the roll. Yoom is designed to have a casual look and feel. It is meant to show wrinkling with most fabrics.

Yoom Soft

PRE-CONFIGURED: SINGLE CHAIR

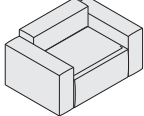
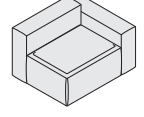
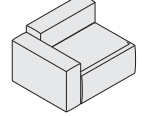
TITLE	SERIES	STYLE	UNIT	DIMENSIONS	COM YDG	COL SQFT	Textile Upholstery Grades										Leather Upholstery Grades									
							COM	A	B	COL	C	D	E	F	G	H	I	J	K	L	M	W	X	Y	E1	E2
Single Chair, Low Both Arms 	Boxed	YM	6	113151P	55.25W x 36.25D x 26H	8.3	124	4,812	5,482	5,847	6,201	6,565	6,925	7,329	7,729	8,201	8,807	9,537	10,265	10,990	11,714	8,323	9,241	12,185	13,422	16,743
	Rolled Front	YM	5	113151P	55.25W x 36.25D x 26H	8	138	4,812	5,463	5,823	6,165	6,518	6,871	7,266	7,655	8,114	8,702	9,411	10,125	10,827	11,535	8,877	9,941	13,354	14,780	18,635
Single Chair, Low Left Arm 	Boxed	YM	6	113151L	45.75W x 36.25D x 26H	7.3	95	3,858	4,379	4,663	4,939	5,223	5,504	5,818	6,130	6,497	6,971	7,540	8,107	8,671	9,235	6,535	7,233	9,478	10,419	12,952
	Rolled Front	YM	5	113151L	45.75W x 36.25D x 26H	6.2	105	3,858	4,360	4,639	4,903	5,176	5,450	5,755	6,056	6,410	6,866	7,414	7,967	8,508	9,056	6,964	7,775	10,384	11,474	14,420
Single Chair, Low Right Arm 	Boxed	YM	6	113151R	45.75W x 36.25D x 26H	7.3	95	3,858	4,379	4,663	4,939	5,223	5,504	5,818	6,130	6,497	6,971	7,540	8,107	8,671	9,235	6,535	7,233	9,478	10,419	12,952
	Rolled Front	YM	5	113151R	45.75W x 36.25D x 26H	6.2	105	3,858	4,360	4,639	4,903	5,176	5,450	5,755	6,056	6,410	6,866	7,414	7,967	8,508	9,056	6,964	7,775	10,384	11,474	14,420

To Order Select Below

1. Series/Style

- YM6
Yoom Soft Boxed
- YM5
Yoom Soft Rolled Front

2. Unit

- 113151P SINGLE CHAIR, LOW BOTH ARMS
- 113151L SINGLE CHAIR, LOW LEFT ARM
- 113151R SINGLE CHAIR, LOW RIGHT ARM

3. Seam Options

- SS SINGLE SEAM ON ALL EDGES
- SP PINCH SEAM ON TOP EDGES
SINGLE SEAM ON SIDE EDGES
- SW STANDARD WELT CORD ON ALL EDGES **+10% OF COM LIST**

4. Glides/Casters/Legs

- PG PLASTIC GLIDE
 - FG FELT GLIDE
 - RG RUBBER GLIDE
- Glide Recommendations**
For easier movement, order Plastic Glides for carpet, Felt Glides for hard floors and Rubber Glides for static positioning.
- CH HARD WHEEL CASTER **+89**
 - CS SOFT WHEEL CASTER **+89**
- Recommended for mobility in collaborative settings.
- L1 ROUND METAL LEGS **+156**
- Round Legs increase seating height by 2". Round Legs are available in standard Stylex powder coated painted metal finishes and Polished Aluminum.

5. Power

- Power
Refer to power ordering steps on page 8.

6. Options

- G GANGING

7. Upholstery

- Upholstery
See general information section for details on textile program and COM/COL information.
- Yoom Rolled textiles must be cut up the roll. Yoom is designed to have a casual look and feel. It is meant to show wrinkling with most fabrics.

Yoom Soft

PRE-CONFIGURED: SINGLE FULL CHAIR

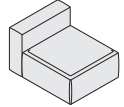
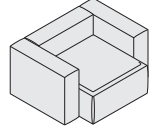
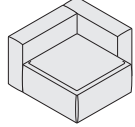
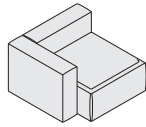
TITLE	SERIES	STYLE	UNIT	DIMENSIONS	COM	COL	Textile Upholstery Grades														Leather Upholstery Grades					
							YDG	SQFT	COM	A	B	COL	C	D	E	F	G	H	I	J	K	L	M	W	X	Y
Single Full Chair, Armless 	Boxed	YM	6	123100	36.25W x 45.25D x 26H	5.5	73	3,363	3,796	4,032	4,261	4,497	4,735	4,994	5,255	5,558	5,955	6,429	6,905	7,369	7,842	5,421	5,958	7,684	8,408	10,358
	Rolled Front	YM	5	123100	36.25W x 45.25D x 26H	5.3	81	3,363	3,787	4,020	4,241	4,473	4,707	4,961	5,217	5,515	5,904	6,367	6,834	7,289	7,753	5,739	6,357	8,356	9,186	11,438
Single Full Chair, High Both Arms 	Boxed	YM	6	123131P	55.25W x 45.25D x 26H	9.7	132	5,657	6,434	6,860	7,275	7,697	8,127	8,594	9,063	9,608	10,321	11,175	12,033	12,867	13,718	9,381	10,350	13,468	14,780	18,304
	Rolled Front	YM	5	123131P	55.25W x 45.25D x 26H	9.4	146	5,657	6,407	6,824	7,215	7,625	8,043	8,495	8,949	9,479	10,168	10,989	11,820	12,627	13,451	9,957	11,075	14,696	16,200	20,276
Single Full Chair, High Left Arm 	Boxed	YM	6	123131L	45.75W x 45.25D x 26H	7.4	103	4,510	5,115	5,446	5,768	6,097	6,431	6,794	7,159	7,583	8,138	8,802	9,469	10,118	10,780	7,401	8,154	10,576	11,594	14,331
	Rolled Front	YM	5	123131L	45.75W x 45.25D x 26H	7.3	113	4,510	5,097	5,422	5,728	6,049	6,375	6,728	7,083	7,497	8,036	8,678	9,327	9,958	10,602	7,848	8,716	11,526	12,693	15,857
Single Full Chair, High Right Arm 	Boxed	YM	6	123131R	45.75W x 45.25D x 26H	7.4	103	4,510	5,115	5,446	5,768	6,097	6,431	6,794	7,159	7,583	8,138	8,802	9,469	10,118	10,780	7,401	8,154	10,576	11,594	14,331
	Rolled Front	YM	5	123131R	45.75W x 45.25D x 26H	7.3	113	4,510	5,097	5,422	5,728	6,049	6,375	6,728	7,083	7,497	8,036	8,678	9,327	9,958	10,602	7,848	8,716	11,526	12,693	15,857

To Order Select Below

1. Series/Style

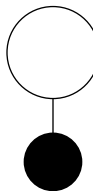

YM6

Yoom Soft Boxed

YM5

Yoom Soft Rolled Front

2. Unit

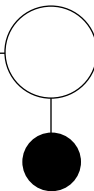

Unit

123100 SINGLE FULL CHAIR, ARMLESS

123131P SINGLE FULL CHAIR, HIGH BOTH ARMS

123131L SINGLE FULL CHAIR, HIGH LEFT ARM

123131R SINGLE FULL CHAIR, HIGH RIGHT ARM

3. Seam Options

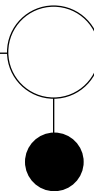

Seam Options

SS SINGLE SEAM ON ALL EDGES

SP PINCH SEAM ON TOP EDGES
SINGLE SEAM ON SIDE EDGES

SW STANDARD WELT CORD ON ALL EDGES **+10% OF COM LIST**

4. Glides/Casters/Legs

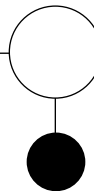

Glides

PG PLASTIC GLIDE

FG FELT GLIDE

RG RUBBER GLIDE

Glide Recommendations
For easier movement, order Plastic Glides for carpet, Felt Glides for hard floors and Rubber Glides for static positioning.

Casters

CH HARD WHEEL CASTER **+89**

CS SOFT WHEEL CASTER **+89**

Recommended for mobility in collaborative settings.

Legs

L1 ROUND METAL LEGS **+156**

Round Legs increase seating height by 2". Round Legs are available in standard Stylex powder coated painted metal finishes and Polished Aluminum.

5. Power

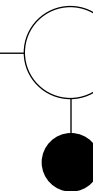

Power

Refer to power ordering steps on page 8.

6. Options

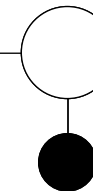

Options

G GANGING

7. Upholstery

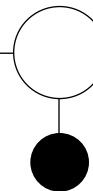

Upholstery

See general information section for details on textile program and COM/COL information.

Yoom Rolled textiles must be cut up the roll. Yoom is designed to have a casual look and feel. It is meant to show wrinkling with most fabrics.

Yoom Soft

PRE-CONFIGURED: SINGLE FULL CHAIR

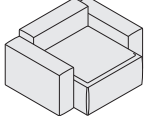
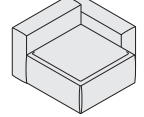
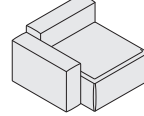
TITLE	SERIES	STYLE	UNIT	DIMENSIONS	COM	COL	Textile Upholstery Grades														Leather Upholstery Grades					
							YDG	SQFT	COM	A	B	C	D	E	F	G	H	I	J	K	L	M	W	X	Y	E1
Single Full Chair, Low Both Arms 	Boxed	YM	6	123151P	55.25W x 45.25D x 26H	9.2	132	5,271	6,002	6,400	6,785	7,181	7,577	8,016	8,453	8,966	9,627	10,423	11,221	12,007	12,800	8,997	9,974	13,098	14,414	17,940
	Rolled Front	YM	5	123151P	55.25W x 45.25D x 26H	8.8	146	5,271	5,993	6,388	6,765	7,157	7,549	7,983	8,415	8,923	9,576	10,361	11,150	11,927	12,711	9,565	10,689	14,296	15,798	19,868
Single Full Chair, Low Left Arm 	Boxed	YM	6	123151L	45.75W x 45.25D x 26H	7.3	103	4,317	4,899	5,216	5,523	5,839	6,156	6,505	6,854	7,262	7,791	8,426	9,063	9,688	10,321	7,209	7,966	10,391	11,411	14,149
	Rolled Front	YM	5	123151L	45.75W x 45.25D x 26H	7	113	4,317	4,890	5,204	5,503	5,815	6,128	6,472	6,816	7,219	7,740	8,364	8,992	9,608	10,232	7,652	8,523	11,326	12,492	15,653
Single Full Chair, Low Right Arm 	Boxed	YM	6	123151R	45.75W x 45.25D x 26H	7.3	103	4,317	4,899	5,216	5,523	5,839	6,156	6,505	6,854	7,262	7,791	8,426	9,063	9,688	10,321	7,209	7,966	10,391	11,411	14,149
	Rolled Front	YM	5	123151R	45.75W x 45.25D x 26H	7	113	4,317	4,890	5,204	5,503	5,815	6,128	6,472	6,816	7,219	7,740	8,364	8,992	9,608	10,232	7,652	8,523	11,326	12,492	15,653

To Order Select Below

1. Series/Style

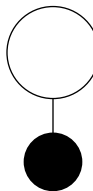

YM6

Yoom Soft Boxed

YM5

Yoom Soft Rolled Front

2. Unit

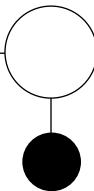

Unit

123151P SINGLE FULL CHAIR, LOW BOTH ARMS

123151L SINGLE FULL CHAIR, LOW LEFT ARM

123151R SINGLE FULL CHAIR, LOW RIGHT ARM

3. Seam Options

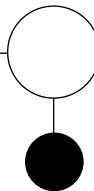

Seam Options

SS SINGLE SEAM ON ALL EDGES

SP PINCH SEAM ON TOP EDGES
SINGLE SEAM ON SIDE EDGES

SW STANDARD WELT CORD ON ALL EDGES **+10% OF COM LIST**

4. Glides/Casters/Legs

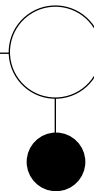

Glides

PG PLASTIC GLIDE

FG FELT GLIDE

RG RUBBER GLIDE

Glide Recommendations
For easier movement, order Plastic Glides for carpet, Felt Glides for hard floors and Rubber Glides for static positioning.

Casters

CH HARD WHEEL CASTER **+89**

CS SOFT WHEEL CASTER **+89**

Recommended for mobility in collaborative settings.

Legs

L1 ROUND METAL LEGS **+156**

Round Legs increase seating height by 2". Round Legs are available in standard Stylex powder coated painted metal finishes and Polished Aluminum.

5. Power

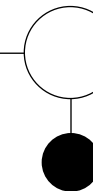

Power

Refer to power ordering steps on page 8.

6. Options

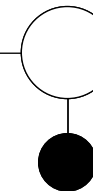

Options

G GANGING

7. Upholstery

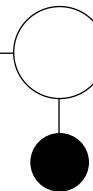

Upholstery

See general information section for details on textile program and COM/COL information.

Yoom Rolled textiles must be cut up the roll. Yoom is designed to have a casual look and feel. It is meant to show wrinkling with most fabrics.

Yoom Soft

PRE-CONFIGURED: DOUBLE CHAIR

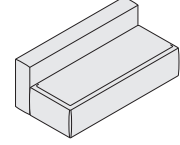
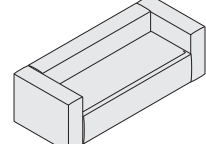
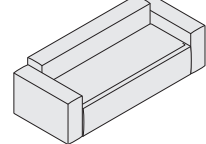
TITLE	SERIES	STYLE	UNIT	DIMENSIONS	COM	COL	Textile Upholstery Grades													Leather Upholstery Grades						
							YDG	SQFT	COM	A	B	COL	C	D	E	F	G	H	I	J	K	L	M	W	X	Y
Double Chair, Armless 	Boxed	YM	6	143400	70.25W x 36.25D x 26H	8.6	114	5,117	5,812	6,191	6,558	6,936	7,316	7,732	8,146	8,635	9,270	10,028	10,787	11,531	12,290	8,323	9,160	11,855	12,978	16,021
	Rolled Front	YM	5	143400	70.25W x 36.25D x 26H	8.3	125	5,117	5,777	6,139	6,487	6,846	7,206	7,601	7,996	8,459	9,061	9,783	10,503	11,212	11,929	8,792	9,755	12,842	14,130	17,615
Double Chair, High Both Arms 	Boxed	YM	6	143431P	89.25W x 36.25D x 26H	12.8	173	7,411	8,450	9,019	9,572	10,136	10,708	11,332	11,954	12,685	13,636	14,774	15,915	17,029	18,166	12,283	13,552	17,639	19,350	23,967
	Rolled Front	YM	5	143431P	89.25W x 36.25D x 26H	12.3	190	7,411	8,397	8,943	9,461	9,998	10,542	11,135	11,728	12,423	13,325	14,405	15,489	16,550	17,627	13,010	14,473	19,182	21,144	26,453
Double Chair, Low Both Arms 	Boxed	YM	6	143451P	89.25W x 36.25D x 26H	12.2	173	7,025	8,018	8,559	9,082	9,620	10,158	10,754	11,344	12,043	12,942	14,022	15,103	16,169	17,248	11,899	13,176	17,269	18,984	23,603
	Rolled Front	YM	5	143451P	89.25W x 36.25D x 26H	11.9	190	7,025	7,983	8,507	9,011	9,530	10,048	10,623	11,194	11,867	12,733	13,777	14,819	15,850	16,887	12,618	14,087	18,782	20,742	26,045

To Order Select Below

1. Series/Style

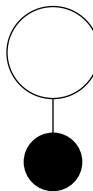

YM6

**Yoom Soft
Boxed**

YM5

**Yoom Soft
Rolled Front**

2. Unit

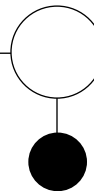

Unit

143400

DOUBLE CHAIR,
ARMLESS

143431P

DOUBLE CHAIR,
HIGH BOTH ARMS

143451P

DOUBLE CHAIR,
LOW BOTH ARMS

3. Seam Options

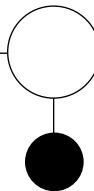

Seam Options

SS

SINGLE SEAM ON ALL EDGES

SP

PINCH SEAM ON TOP EDGES
SINGLE SEAM ON SIDE EDGES

SW

STANDARD WELT CORD
ON ALL EDGES

**+10% OF
COM LIST**

4. Glides/Casters/Legs

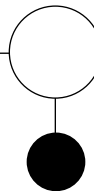

Glides

PG

PLASTIC GLIDE

FG

FELT GLIDE

RG

RUBBER GLIDE

Glide Recommendations

For easier movement, order Plastic Glides for carpet, Felt Glides for hard floors and Rubber Glides for static positioning.

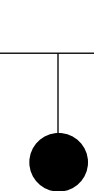

Legs

L1

ROUND METAL LEGS **+156**

Round Legs increase seating height by 2". Round Legs are available in standard Stylex powder coated painted metal finishes and Polished Aluminum.

5. Power

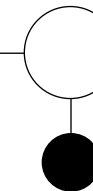

Power

Refer to power ordering steps on [page 8](#).

6. Options

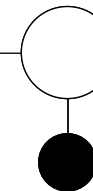

Options

G

GANGING

7. Upholstery

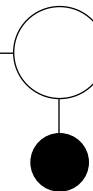

Upholstery

See [general information section](#) for details on textile program and COM/COL information.

Yoom Rolled textiles must be cut up the roll. Yoom is designed to have a casual look and feel. It is meant to show wrinkling with most fabrics.

Yoom Soft

PRE-CONFIGURED: DOUBLE FULL CHAIR

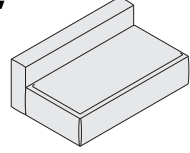
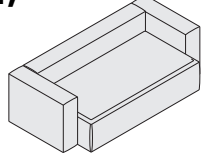
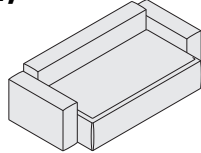
TITLE	SERIES	STYLE	UNIT	DIMENSIONS	COM	COL	Textile Upholstery Grades										Leather Upholstery Grades									
							YDG	SQFT	COM	A	B	C	D	E	F	G	H	I	J	K	L	M	W	X	Y	E1
Double Full Chair, Armless 	Boxed	YM	6	153400	70.25W x 45.25D x 26H	9.7	125	6,032	6,814	7,241	7,653	8,082	8,507	8,974	9,441	9,991	10,706	11,558	12,411	13,251	14,103	9,544	10,462	13,419	14,648	17,979
	Rolled Front	YM	5	153400	70.25W x 45.25D x 26H	9.4	137	6,032	6,781	7,190	7,582	7,989	8,397	8,845	9,293	9,816	10,497	11,313	12,129	12,929	13,742	10,065	11,119	14,506	15,918	19,741
Double Full Chair, High Both Arms 	Boxed	YM	6	153431P	89.25W x 45.25D x 26H	13.9	184	8,326	9,452	10,069	10,667	11,282	11,899	12,574	13,249	14,041	15,072	16,304	17,539	18,749	19,979	13,504	14,854	19,203	21,020	25,925
	Rolled Front	YM	5	153431P	89.25W x 45.25D x 26H	13.5	202	8,326	9,401	9,994	10,556	11,141	11,733	12,379	13,025	13,780	14,761	15,935	17,115	18,267	19,440	14,283	15,837	20,846	22,932	28,579
Double Full Chair, Low Both Arms 	Boxed	YM	6	153451P	89.25W x 45.25D x 26H	13.3	184	7,940	9,020	9,609	10,177	10,766	11,349	11,996	12,639	13,399	14,378	15,552	16,727	17,889	19,061	13,120	14,478	18,833	20,654	25,561
	Rolled Front	YM	5	153451P	89.25W x 45.25D x 26H	13	202	7,940	8,987	9,558	10,106	10,673	11,239	11,867	12,491	13,224	14,169	15,307	16,445	17,567	18,700	13,891	15,451	20,446	22,530	28,171

To Order Select Below

1. Series/Style

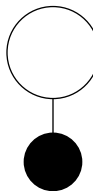

YM6

**Yoom Soft
Boxed**

YM5

**Yoom Soft
Rolled Front**

2. Unit

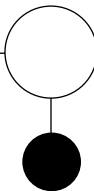

Unit

153400 DOUBLE FULL CHAIR, ARMLESS

153431P DOUBLE FULL CHAIR, HIGH BOTH ARMS

153451P DOUBLE FULL CHAIR, LOW BOTH ARMS

3. Seam Options

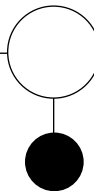

Seam Options

SS SINGLE SEAM ON ALL EDGES

SP PINCH SEAM ON TOP EDGES
SINGLE SEAM ON SIDE EDGES

SW STANDARD WELT CORD ON ALL EDGES **+10% OF COM LIST**

4. Glides/Casters/Legs

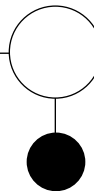

Glides

PG PLASTIC GLIDE

FG FELT GLIDE

RG RUBBER GLIDE

Glide Recommendations
For easier movement, order Plastic Glides for carpet, Felt Glides for hard floors and Rubber Glides for static positioning.

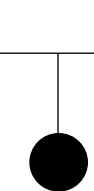

Legs

L1 ROUND METAL LEGS **+156**

Round Legs increase seating height by 2". Round Legs are available in standard Stylex powder coated painted metal finishes and Polished Aluminum.

5. Power

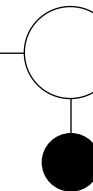

Power

Refer to power ordering steps on [page 8](#).

6. Options

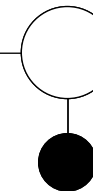

Options

G GANGING

7. Upholstery

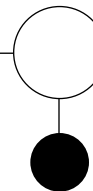

Upholstery

See [general information section](#) for details on textile program and COM/COL information.

Yoom Rolled textiles must be cut up the roll. Yoom is designed to have a casual look and feel. It is meant to show wrinkling with most fabrics.

Yoom Soft

PRE-CONFIGURED: CHAISE, CORNER, & SINGLE NARROW

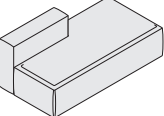
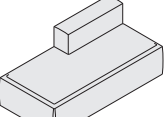
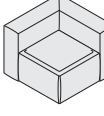
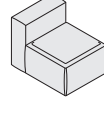
TITLE	SERIES	STYLE	UNIT	DIMENSIONS	COM	COL	Textile Upholstery Grades														Leather Upholstery Grades					
							YDG	SQFT	COM	A	B	COL	C	D	E	F	G	H	I	J	K	L	M	W	X	Y
Chaise Right w/Back 	Boxed	YM	6	1631	70.25W x 36.25D x 26H	7.4	94	5,041	5,623	5,941	6,250	6,564	6,883	7,231	7,579	7,988	8,519	9,153	9,789	10,413	11,046	7,688	8,374	10,592	11,520	14,025
	Rolled Front	YM	5	1631	70.25W x 36.25D x 26H	7.2	103	5,041	5,605	5,915	6,210	6,518	6,828	7,164	7,503	7,902	8,415	9,029	9,646	10,253	10,868	8,072	8,861	11,410	12,471	15,343
Chaise Left w/Back 	Boxed	YM	6	1731	70.25W x 36.25D x 26H	7.4	94	5,041	5,623	5,941	6,250	6,564	6,883	7,231	7,579	7,988	8,519	9,153	9,789	10,413	11,046	7,688	8,374	10,592	11,520	14,025
	Rolled Front	YM	5	1731	70.25W x 36.25D x 26H	7.2	103	5,041	5,605	5,915	6,210	6,518	6,828	7,164	7,503	7,902	8,415	9,029	9,646	10,253	10,868	8,072	8,861	11,410	12,471	15,343
Corner Chair 	Boxed	YM	6	1337	36.25W x 36.25D x 26H	5	75	3,282	3,693	3,914	4,131	4,353	4,576	4,820	5,063	5,352	5,722	6,168	6,616	7,052	7,497	5,387	5,938	7,701	8,442	10,433
Single Narrow Chair 	Boxed	YM	6	1333	27.25W x 36.25D x 26H	3.3	53	2,519	2,783	2,923	3,060	3,202	3,346	3,500	3,656	3,840	4,077	4,361	4,647	4,926	5,210	4,008	4,399	5,647	6,171	7,581
	Rolled Front	YM	5	1333	27.25W x 36.25D x 26H	4	57	2,519	2,841	3,017	3,186	3,360	3,537	3,732	3,919	4,148	4,442	4,791	5,142	5,489	5,838	4,197	4,652	6,071	6,665	8,267

To Order Select Below

1. Series/Style

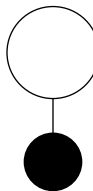

YM6

**Yoom
Boxed**

YM5

**Yoom
Rolled Front**

2. Unit

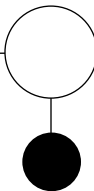

Unit

1631 CHAISE RIGHT W/BACK

1731 CHAISE LEFT W/BACK

1337 CORNER CHAIR

1333 SINGLE NARROW CHAIR

For a rolled front corner chair, modular pieces **YM913** (boxed single narrow seat) and **YM837** (rolled front corner back) should be used together.

3. Seam Options

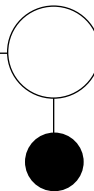

Seam Options

SS SINGLE SEAM ON ALL EDGES

SP PINCH SEAM ON TOP EDGES
SINGLE SEAM ON SIDE EDGES

SW STANDARD WELT CORD ON ALL EDGES **+10% OF COM LIST**

4. Glides/Casters/Legs

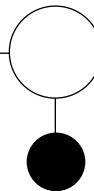

Glides

PG PLASTIC GLIDE

FG FELT GLIDE

RG RUBBER GLIDE

Glide Recommendations
For easier movement, order Plastic Glides for carpet, Felt Glides for hard floors and Rubber Glides for static positioning.

Casters

CH HARD WHEEL CASTER **+89**

CS SOFT WHEEL CASTER **+89**

Not available on chaise. Recommended for mobility in collaborative settings.

Legs

L1 ROUND METAL LEGS **+156**

Round Legs increase seating height by 2". Round Legs are available in standard Stylex powder coated painted metal finishes and Polished Aluminum.

5. Power

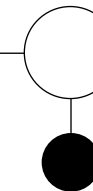

Power

Refer to power ordering steps on page 8.

6. Options

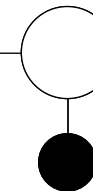

Options

G GANGING

7. Upholstery

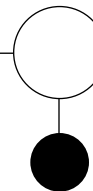

Upholstery

See general information section for details on textile program and COM/COL information.

Yoom Rolled textiles must be cut up the roll. Yoom is designed to have a casual look and feel. It is meant to show wrinkling with most fabrics.