

**stylex**

# **Luna**

PRICE LIST  
Effective June 10, 2024

# General Information

## STYLEX PRICE LIST

### GENERAL INFORMATION

#### Terms

Net 30 days from date of invoice,  
F. O. B . Delanco, New Jersey.

#### Damaged Shipments

All Stylex products are carefully inspected before they are packed in sturdy cartons designed to satisfy shipping requirements. Stylex is not responsible for damage in shipment. The transportation company assumes responsibility for delivering products to you in good condition when the bill of lading is signed. You protect yourself by refusing shipments showing damage or shortage until transportation company has noted on the delivery sheet the extent of damage or shortage. Concealed damage should be reported to the carrier as soon as discovered, but no later than 5 days after receiving shipment.

#### Return/Restocking Policy

Return shipments will not be accepted unless specifically authorized by Stylex in writing. The Return Authorization number should be clearly marked on the carton. The customer returning Stylex products is responsible for return shipping costs. Merchandise must be returned unused. Returned merchandise is subject to a 35% restocking fee.

#### Custom Products

Modifications to standard products will be considered for large runs. Contact factory for price quotations.

#### Design Changes

In keeping with modern manufacturing advances, Stylex reserves the right to incorporate minor modifications and design changes in products without notice.

#### Cancellation/Change Order Policy

Regarding requests for order cancellation and/or order modification, please be advised that no charges will be applied before production, unless inventory has been specifically requisitioned to fulfill your order. Once orders proceed to the production phase, they cannot be altered or canceled under any circumstances. All requests for order cancellations or order changes must be submitted in writing and will only be considered valid upon approval by Stylex.

### WARRANTY

Except as provided below, Stylex warrants exclusively to the original Purchaser of our product that all parts, under normal use and service, will be free from defects in workmanship and material for a period of ten (10) years from the date of purchase. "Normal use and service" means that the product will be used in a typical office environment for 40-45 hours per week.

This warranty is subject to the following limitations, exclusions and provisions:

Limitations involving materials and components:

**Wood components of plywood stacking chairs**  
(such as Brooks and Welcome)  
5 years

#### Upholstery

(including mesh used for Click, F4, Insight, and Zephyr Mesh)  
3 years

#### SAVA Mesh

10 years

#### COM Upholstery

No warranty  
Stylex makes every effort to ensure that the COM Upholstery it approves is suitable for the intended use. Nevertheless, we will not warrant, and assume no responsibility for, the durability or tailoring quality of any COM or COL . If you have any concerns about the ultimate appearance of any covering, please order an upholstered sample.

#### Painted Stack Chair Frames

No Warranty

We will not warrant the finish of painted stack chair frames against damage from stacking. Please order chrome frames for chairs that will be stacked.

#### Felt Glides

No warranty

Due to the different surfaces on which felt glides may be used, we cannot warrant their durability over time.

If this product fails during normal use and service within the applicable warranty period (other than through normal wear and tear), please send a description of the relevant part and the nature of the defect, together with proof of purchase of the product to [qm@stylexdesign.com](mailto:qm@stylexdesign.com). PLEASE DO NOT RETURN PARTS OR THE PRODUCT TO STYLEX UNLESS INSTRUCTED TO DO SO BY STYLEX. Stylex will, at its discretion, either repair or replace the defective product or part at no cost. Labor requests must receive approval and will be authorized on a case-by-case basis. We will only reimburse for labor costs directly incurred, excluding any travel-related expenses. Purchaser may be required (at the option of Stylex) to return to Stylex at Purchaser's expense any defective part with all freight or shipping charges prepaid. The foregoing warranty shall be void if the product has been altered or repaired (other than by Stylex). The warranty does not cover damage to the product caused by accident, neglect, misuse, abuse, modification to the product by anyone other than Stylex or damage caused by use of the product for a purpose other than that for which it was designed. This warranty extends only to the original Purchaser of the product.

#### No Other Warranties

This warranty is in lieu of all other warranties, expressed or implied, including, but not limited to, implied warranties of merchantability and fitness for a particular purpose. The rights and remedies provided herein are the exclusive rights and remedies of the original purchaser of the product.

#### No Liability For Damages

In no event shall Stylex or its suppliers be responsible or liable for any special, indirect, consequential, or incidental damages. In no event shall the liability of Stylex exceed the actual purchase price paid to Stylex for the product.

#### Out of Warranty Products

For all products no longer covered by our warranty, please refer to our Design for Durability and Upgradability Policy. Contact Customer Service if you would like to purchase any replaceable components to further extend the life of any Stylex seating product. This warranty applies to all Stylex products purchased on April 13, 2018, and thereafter.

### PRODUCT TAKE BACK PROGRAM

In order to be good stewards of our products, Stylex offers a pathway towards a Product Take Back Program as a more viable solution to the end of our products' originally intended life.

Stylex supports the sustainable programs of ANEW and offers their added value to our clients through a comprehensive take-back solution for surplus office furniture and materials of any kind, in any condition. ANEW is a 501(c)(3) non-profit organization that exists to provide companies with smart, cost effective alternatives for their surplus furniture and other items with the priority of matching it to non- profits, public agencies and the underserved, within the local community of the project site. Corporate Social Responsibility is raised while the impact on the environment is lowered by diverting products and materials otherwise destined for landfill.

Stylex is proud to offer ANEW to customers dedicated to strengthening their community network by repurposing their furniture, fixtures and architectural materials to those in need. In 2014, Stylex committed to making this relationship a part of our strategic sales strategy. Visit [www.anewfound.org](http://www.anewfound.org) to find out more.

To initiate a Product Take Back strategy through ANEW, contact Stylex Customer Service at 800-257-5742.

For other end of life recovery options, please see our Product Disassembly Instructions and End of Life Recovery Options documents available on our website in the resources section of each product in our line.

### FREIGHT PROGRAM

Freight charges will be calculated as a percentage of the net product price and added to the invoice at the time of shipment. The continental United States has been divided into three zones. Please use the map below to determine freight charges for the product's destination. Minimum freight charge is \$150. Please let us know if you will be shipping to a residential address or require inside delivery as this requires an additional fee. Also please note we need to be made aware if a liftgate is required prior to delivery. If any requests are made at the time of delivery, applicable charges will apply.

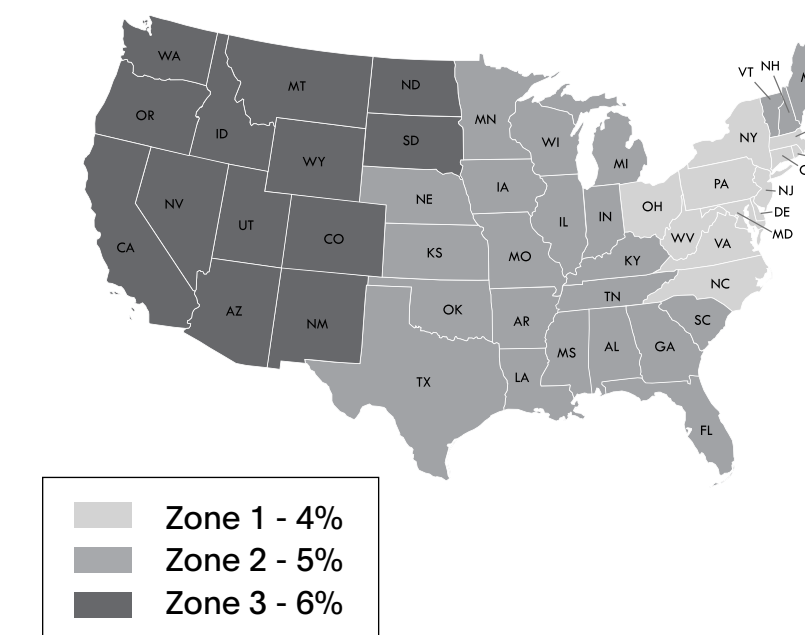

### ZONE 1 - 4%

Connecticut  
Delaware  
New York  
New Jersey  
Maryland  
Massachusetts  
North Carolina  
Ohio  
Pennsylvania  
Rhode Island  
Virginia  
Washington D.C.  
West Virginia

### ZONE 2 - 5%

Alabama  
Arkansas  
Canada, Ontario  
Canada, Quebec  
Florida  
Georgia  
Iowa  
Illinois  
Indiana  
Kansas  
Kentucky  
Louisiana  
Nebraska  
New Hampshire  
Oklahoma  
Maine  
Michigan  
Minnesota  
Missouri  
Mississippi  
South Carolina  
Tennessee  
Texas  
Vermont  
Wisconsin

### ZONE 3 - 6%

Arizona  
California  
Colorado  
Idaho  
Montana  
Nevada  
New Mexico  
North Dakota  
Oregon  
South Dakota  
Utah  
Washington  
Wyoming

#### Quote Per Project

Alaska  
Hawaii  
Canada  
(outside Ontario & Quebec)  
Mexico

# General Information

## STYLEX PRICE LIST

### TEXTILE PARTNERS & APPROVALS

#### Textile Partners

To customize your furniture performance needs and design vision, Stylex offers a wide selection of in-graded leathers and textiles from Grades A through Y. We've partnered with leading manufacturers on the options, focusing on color, price, durability, and construction. To view our partners and explore our digital carded program with broadly approved textiles, visit [this page](#). We stand by these textiles: They're tried and tested, and will effortlessly fit into any design aesthetic.

#### Textile Approvals

All textiles must be approved for the product you are specifying. For the related approved textile lists, visit [this page](#).

### CAL 117 AND 133 COMPLIANCE

#### CAL 117-2013

All Stylex seating satisfies the requirements of CAL 117-2013 so long as one of our standard or in-graded fabrics is applied. COM textiles cannot be so guaranteed. Please contact the supplier of COM's directly to determine the fire retardancy of any COM supplied to us.

#### CAL 133

Most Stylex seating can be ordered to meet the requirements of CAL 133. When ordering, simply specify "CAL 133 compliance required". The upcharge for this option is \$54 list per yard. Please refer to the COM yardage of each model to determine the number of yards required. We do frequently require full-scale burn tests in order to certify CAL 133 before an order will be accepted. Such burn tests may increase normal lead times and do carry additional charges. Please contact customer service for details.

### CUSTOMER'S OWN MATERIAL/LEATHER

Customer's own material (COM) and customer's own leather (COL) will generally be upholstered at the price designated in each product's price list. Please be advised, however, that we specifically reserve the right to charge a higher price when we determine that special circumstances, such as unusual repeats or challenging materials, present themselves. All orders for custom coverings must be approved by Stylex before they will be accepted for production. To submit proposed textile for approval, please use the COM form [here](#).

#### Special Note:

We assume no responsibility for the durability or tailoring quality of any COM or COL. Directional covers in particular may not meet your satisfaction due to the design of certain products. Please be advised that COM and COL orders are not subject to return. If you have doubts about the ultimate appearance of certain coverings, please order a sample done with that specific COM or COL. In addition, while we inspect fabrics for mill imperfections, some are difficult to recognize. We cannot be responsible for defects, color inaccuracies, dye lot variations, or other flaws.

Under no circumstances will we be responsible for COM shortages, flaws, or other such problems. Finally, it is not our responsibility to police the receipt of COM's in order to meet delivery deadlines, and we assume our customers are aware of any undue delay in the shipment of their COM fabrics.

**COM fabric and COL leather should be sent prepaid to: Stylex**

**Attn: COM/COL - [Your PO #]  
740 Coopertown Road  
Delanco, NJ 08075**

**Clearly mark fabric or leather with the dealers name, purchase order number, and furniture model number of the item to be covered. Actual furniture orders should include the same information, as well as a description of the fabric or leather, including pattern and color number, in order to provide a cross reference.**

Yardage requirements shown in the price list are based on non-directional goods of 54" width. Fabrics less than 54" wide or those requiring matching (stripes, prints, or large patterned designs) call for additional yardage. We will be happy to supply yardage requirements for large quantities where economies may be realized.

**Add the following yardage for stripes, plaids, or patterns with repeats:**

Fabric Width	Plain Fabric	2-14" Repeat	15-24" Repeat	25-27" Repeat	28-36" Repeat
54"	0%	10%	15%	20%	25%
50"	10%	20%	25%	30%	35%
48"	15%	25%	30%	35%	40%
45"	40%	50%	55%	60%	65%
36"	50%	60%	65%	70%	75%

### COM/COL FORM

To avoid delay in processing COM orders we request that you submit a sample of your COM fabric stapled to this form which can be downloaded [here](#). If a fabric has a stripe or design, the size of the repeat should be indicated. Please indicate the fabric supplier's name, fabric number, and color. Also indicate the Stylex product on which the fabric will be used.

The fabric supplier must indicate on his shipping labels the dealer name and purchase order number as well as the Stylex model number.

#### Please Note:

No order may be entered into production or have a shipping date assigned until all related COM is received at the factory.



### CENTER OF STRIPE OR DESIGN

TOP OF CHAIR	TOP OF CHAIR
--------------	--------------

1. Size of Repeat

2. Fabric Supplier

3. Fabric Number

4. Color

5. Stylex Product

# Luna

# Contents

ABOUT	5	SEATING: ELEVATED	17
STATEMENT OF LINE	6	SEATING: PLINTH	25
PRODUCT INFORMATION	10	TRAY TABLE	33
DIMENSIONS	11	TABLET ARM	34
HOW TO ORDER	13	PLANTER	36
COLORS, MATERIALS, AND FINISHES	16		

CLICK THE TITLES ABOVE TO NAVIGATE THROUGH THE DOCUMENT  
PRODUCT HEADERS ON SUBSEQUENT PAGES LINK BACK TO THIS PAGE

# Luna

ABOUT

Introducing Luna, banquette seating that offers precise customization down to the inch, ensuring a perfect fit even in the most unconventional spaces. With segments ranging from 25" to 60", Luna allows you to create symmetrical and tailored seating arrangements, whether running or stand alone, with the option for half-moon-shaped arms. Luna seamlessly integrates with our Still screens, and the collection includes options for high or low backs, a planter for enclosed layouts, and a trio of accessory tables. Pricing is offered in seven different buckets, conveniently divided into 5" increments, ensuring efficiency and ease in specification. For layout assistance, our Design Application team is at your service – get in touch at [designapplication@stylexdesign.com](mailto:designapplication@stylexdesign.com).



ELEVATED, LOW BACK



PLINTH, HIGH BACK, PLANTERS

# Luna

## SPECIFICATION GUIDE: STATEMENT OF LINE, ELEVATED SEATING

### OVERVIEW

<b>Elevated Low Back</b>	Standard	Arm Left	Arm Right	Arm Both	Armless End Left	Armless End Right
	Round Inside Corner	Square Inside Corner	Round Outside Corner	Round End Cap		
<b>Elevated High Back</b>	Standard	Arm Left	Arm Right	Arm Both	Armless End Left	Armless End Right
	Round Inside Corner	Square Inside Corner	Round Outside Corner	Round End Cap		

### PRODUCT INFORMATION

#### Design

A Stylex Design, by Anthony Land

#### Legs (Elevated)

Elevated units come with cast aluminum legs, available in a polished finish and Stylex's standard powder coat colors. They can also be ordered without legs for custom millwork.

#### Configuration

Luna can be ordered as freestanding units or as part of a larger layout. When ordering, it's crucial to specify whether each line item is freestanding or for the start/mid/end of a layout. Arrange them from left to right as viewed from a seated perspective. We highly recommend using CET Designer for specifying this product for optimal accuracy.

#### Use

Designed for indoor use only.

#### Performance Standards

Manufactured to comply with:  
ANSI/BIFMA X5.4 Lounge Seating Tests

#### Certifications

GREENGUARD Gold  
BIFMA LEVEL® 2 Certified

# Luna

## SPECIFICATION GUIDE: STATEMENT OF LINE, PLINTH SEATING

OVERVIEW						
<b>Plinth Low Back</b>	Standard	Arm Left	Arm Right	Arm Both	Armless End Left	Armless End Right
	Round Inside Corner	Square Inside Corner	Round Outside Corner	Round End Cap		
<b>Plinth High Back</b>	Standard	Arm Left	Arm Right	Arm Both	Armless End Left	Armless End Right
	Round Inside Corner	Square Inside Corner	Round Outside Corner	Round End Cap		

### PRODUCT INFORMATION

**Design**

A Stylex Design, by Anthony Land

**Toe Kick (Plinth)**

Plinth units include a 2.625" black laminate toe kick.

**Configuration**

Luna can be ordered as freestanding units or as part of a larger layout. When ordering, it's crucial to specify whether each line item is freestanding or for the start/mid/end of a layout. Arrange them from left to right as viewed from a seated perspective. We highly recommend using CET Designer for specifying this product for optimal accuracy.

**Use**

Designed for indoor use only.

**Performance Standards**

Manufactured to comply with:  
ANSI/BIFMA X5.4 Lounge Seating Tests

**Certifications**

GREENGUARD Gold  
BIFMA LEVEL® 2 Certified

# Luna

## SPECIFICATION GUIDE: STATEMENT OF LINE, PLANTERS, TRAYS AND TABLET ARMS

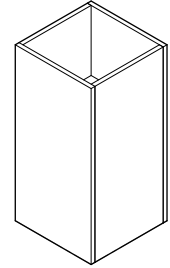
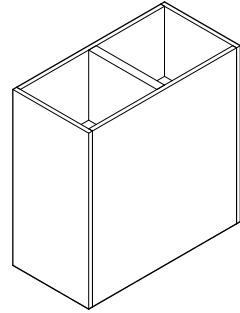
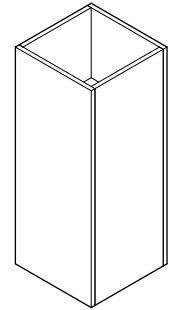
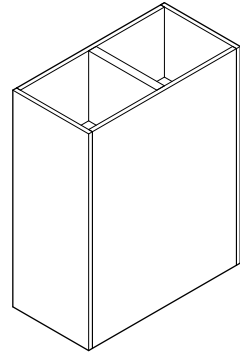
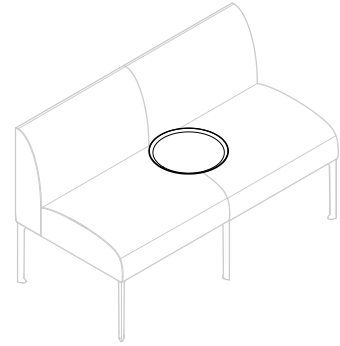
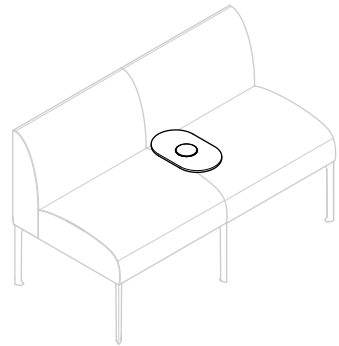
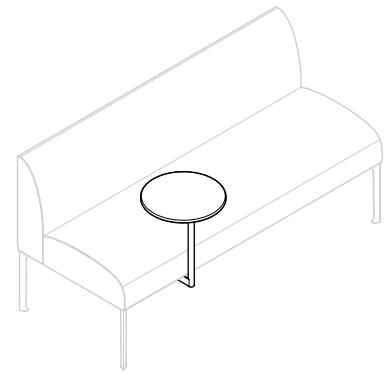
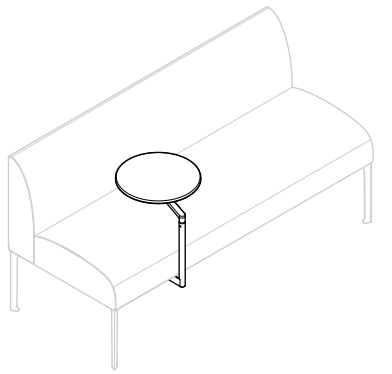
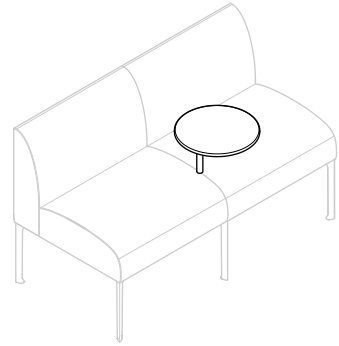
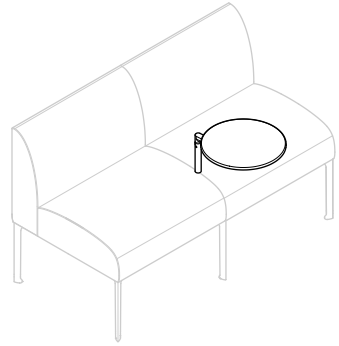
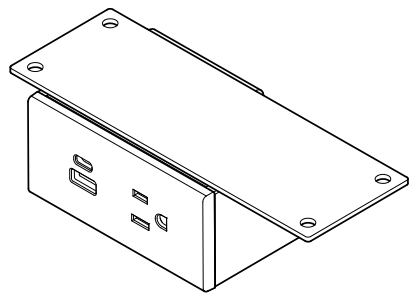
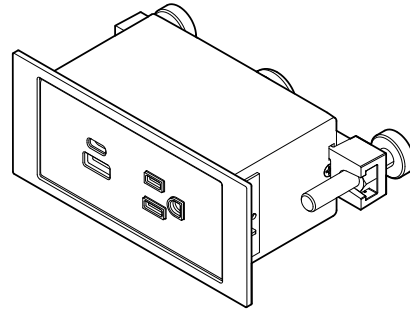
OVERVIEW						
<b>Planter Low Back Height</b>	Single 	Double 				
<b>Planter High Back Height</b>	Single 	Double 				
<b>Tray &amp; Tablet Arm</b>	Round Tray Table 	Wireless Charging Tray 	Under Mount, Single Swivel 	Under Mount, Dual Swivel 	Seat Mount, Single Swivel 	Seat Mount, Dual Swivel 
<b>Power</b>	Under Mount (for Elevated style) 	Flush Mount (for Plinth style) 				

## PRODUCT INFORMATION

### Planters

Planters extend to the floor, resting on height-adjustable glides, and feature a black laminate finish over an MDF core. They are concealed on all vertical sides by seat units or a wall. Please note that enclosed planters are not intended to be exposed; they should be surrounded by seating units or placed against a wall. Exposed planters can be exposed on all sides.

### Tray Tables and Tablet Arms

The round tray table is made of steel and available in 26 powder coat finishes.

The wireless charging tray comes in four different solid wood finish options, featuring a black wireless surface mount charging unit in the center of the oval top.

Tablet arms are available in single or dual swivel, with four solid wood finish options.

### Power

Elevated units offer undermount power beneath the seats, while plinth units offer flush mount power in the front. You can specify power units to be hardwired or equipped with a 3-prong plug. These units feature one USB-A port, one USB-C port, and a standard grounded 3-prong electrical outlet. Additional power options include daisy chain and wireless surface mount charging. Default cord lengths are 10 feet, with custom lengths available. Power units come with wire management clips for every 1-foot length of cord. Daisy chain infeeds are offered in 5', 10', and 15' standard lengths.

### Use

Designed for indoor use only.

### Performance Standards

Manufactured to comply with:  
ANSI/BIFMA X5.4 Lounge Seating Tests





### Certifications

GREENGUARD Gold  
BIFMA LEVEL® 2 Certified

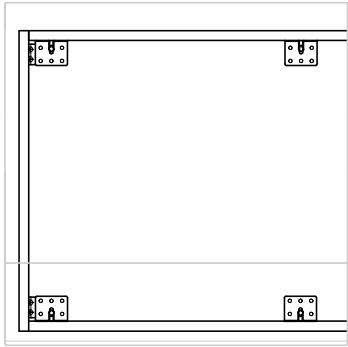
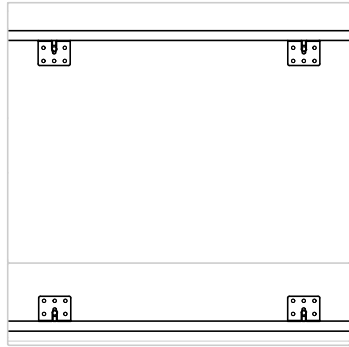
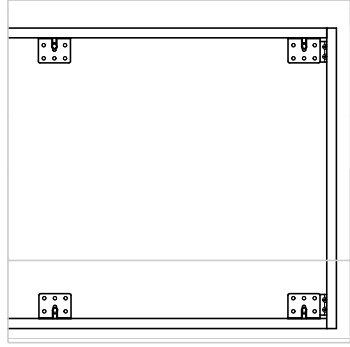
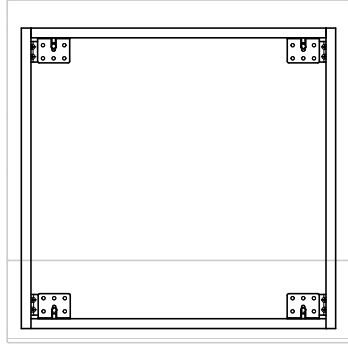
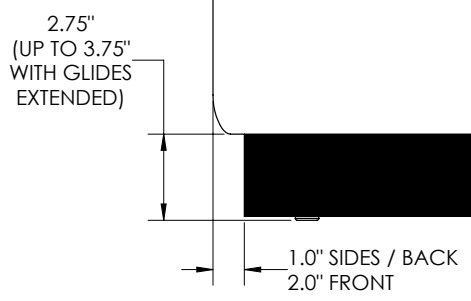
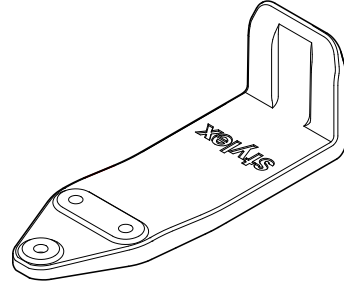
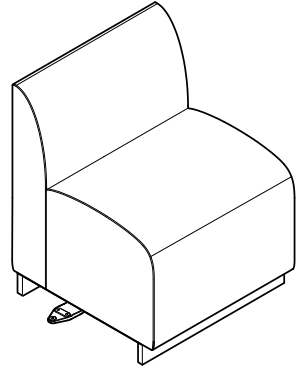
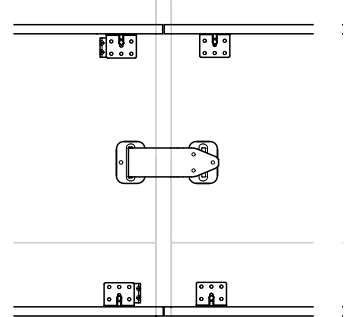
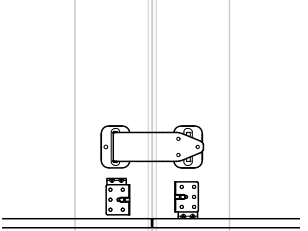
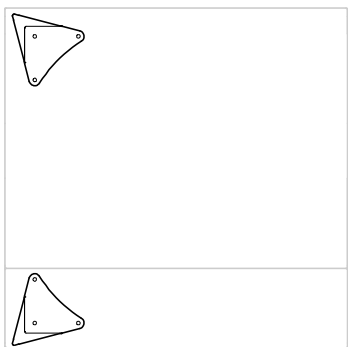
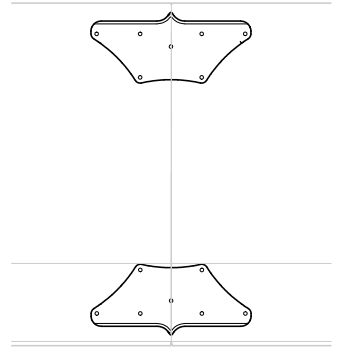
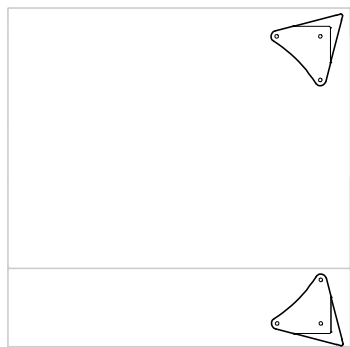
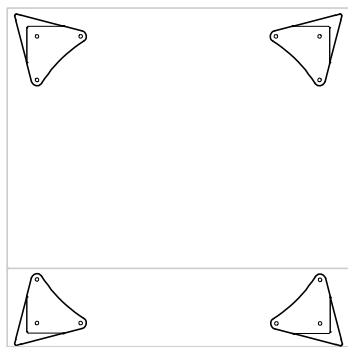
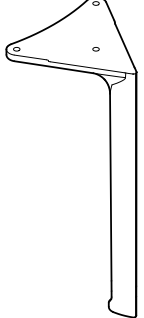
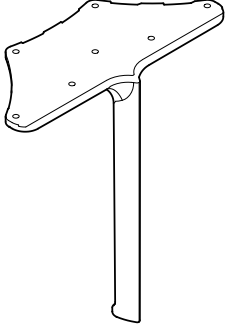

# Luna

## SPECIFICATION GUIDE: ACCESSORIES AND DETAILS

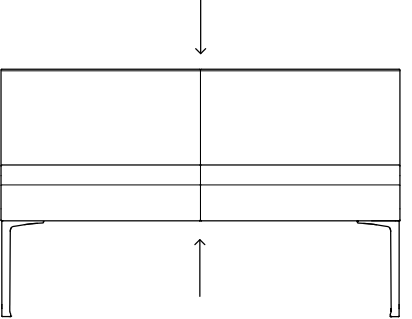
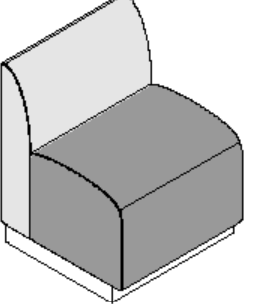
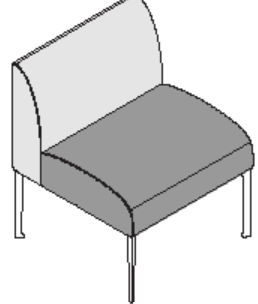
OVERVIEW						
<b>Plinth Position</b>	Start 	Mid 	End 	Freestanding 		Plinth Inset 
<b>Plinth Ganging</b>	Ganging Bracket 		Side-to-Side 	Back-to-Back 		
<b>Elevated Leg Position</b>	Start 	Mid 	End 	Freestanding 	Start, End Leg Elevated 	Mid Leg Elevated 
<b>Upholstery Details</b>	Standard 	Armless End 	Arm 	Mid Seam (for units 46" and larger) 	Dual Fabric for Plinth Textile 1 - Seat Textile 2 - Back 	Dual Fabric for Elevated Textile 1 - Seat Textile 2 - Back 

## PRODUCT INFORMATION

### Plinth

The plinth is designed to provide a continuous appearance at the front, back, and exposed ends of a unit. However, the plinth side panels are removed when ordered as the Start, Mid, and End of a ganged layout.

### Ganging

Elevated style units employ mid legs for ganging seating units side-to-side and back-to-back, while plinth style units use ganging brackets to connect seats in the same manner. Plinth Start, Mid, and End units can be ganged side-to-side and come with cast aluminum drop-on ganging brackets for tool-free assembly.

### Elevated - Legs

Elevated seats share a leg between non-standalone units, while standalone units have four legs. The legs for elevated units are installed in the field.

### Glides

All units come standard with adjustable glides, allowing for 3/4" adjustment.

### Upholstery Details

- Standard units feature a top-edge seam and are designed to be flush side to side.
- Armless End and Arm units have a roll-style seam at the exposed end of a layout.
- Units 46" and larger include a middle seam.
- Luna offers a dual upholstery option.

### Use

Designed for indoor use only.

### Performance Standards

Manufactured to comply with:  
ANSI/BIFMA X5.4 Lounge Seating Tests

### Certifications

GREENGUARD Gold  
BIFMA LEVEL® 2 Certified

# Luna

## SPECIFICATION GUIDE: PRODUCT INFORMATION, POWER

OVERVIEW	POSITION 2 (RIGHT)	POSITION 1 AND 2 (LEFT AND RIGHT)	POSITION 1 (LEFT)
<b>Elevated</b>			
<b>Plinth Standard</b>			
<b>Plinth with Arm(s) (Arm Right Shown)</b>			
<b>Plinth Armless (Armless Right Shown)</b>			

### PRODUCT INFORMATION

#### Power

Elevated units offer undermount power beneath the seats, while plinth units offer flush mount power in the front. You can specify power units to be hardwired or equipped with a 3-prong plug. These units feature one USB-A port, one USB-C port, and a standard grounded 3-prong electrical outlet. Additional power options include daisy chain and wireless surface mount charging. Default cord lengths are 10 feet, with custom lengths available. Power units come with wire management clips for every 1-foot length of cord. Daisy chain infeeds are offered in 5', 10', and 15' standard lengths.

#### Mounting Options

Under mount power is designated by (U) in the model code. Flush mount power is designated by (F) in the model code.

#### Cord Length

Both the standard cord and the conduit whip are 10ft long. Other lengths are available as a custom order.

#### Colors

Under mount power units are offered in black (B), gray (G), and white (W), while flush mount power units are available in black (B) only.

#### Cable Management

All elevated units include cable mounts and screws for assembly and installation. Power units come with wire management clips for every 1-foot length of cord.

For plinth units against a wall, the rear-side toe kick can be removed to allow for cord egress.

For plinth units not against a wall, the unit may be raised up by extending the glides or the installer may cut a small mouse hole in the toe kick. See assembly instructions for more information.

#### Location

On elevated units, the power is located under the front edge, next to the leg. For plinth units, the power is flush to the front, positioned 8" on center from the side of the unit. However, for arm and armless units, the power is located 16" on center from that side. Units with a tapered front (Arm and Armless) under 45" in length cannot have power on the same side as the arm feature. For units 46" and longer, both left and right power options are available. Units with two arms under 45" in length cannot have power, and power is not available for corner or endcap units.

#### Example

UB1 - Under mount, black, position 1  
FHB12 - Flush mount, hardwired, black, positions 1 & 2

### To Order Select Below

#### 1. Power Type

	<b>Power</b>
--	STANDARD POWER
DC	DAISY CHAINED

#### 2. Mount Type

	<b>Mount</b>	
U	UNDER MOUNT (ELEVATED)	<b>+623</b>
F	FLUSH MOUNT (PLINTH)	<b>+568</b>
UH	UNDER MOUNT HARDWIRE (ELEVATED)	<b>+816</b>
FH	FLUSH MOUNT HARDWIRE (PLINTH)	<b>+784</b>

Hardwire only available in Standard Power

#### 3. Color

	<b>Color</b>
B	BLACK
G	GRAY
W	WHITE

Flush mount only available in black and gray.

#### 4. Location

	<b>Location</b>
1	POSITION 1 (LEFT)
2	POSITION 2 (RIGHT)

# Luna

## SPECIFICATION GUIDE: PRODUCT INFORMATION, DAISY CHAIN POWER

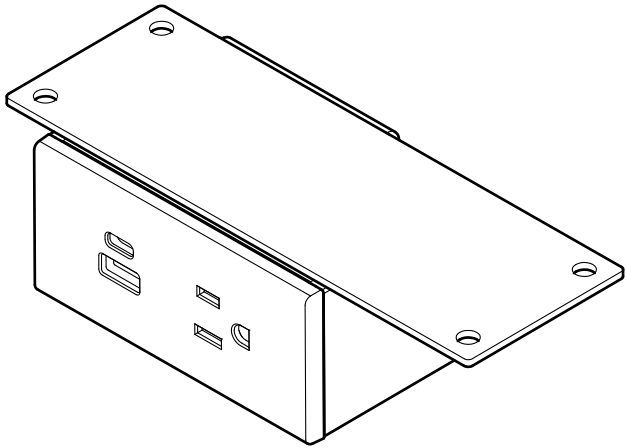
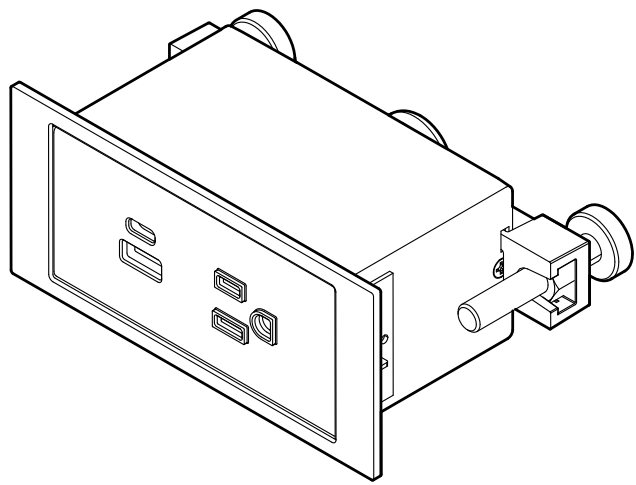
OVERVIEW	UNDER MOUNT (ELEVATED)	SURFACE MOUNT (PLINTH)	
<p><b>Power Units</b></p>			

### PRODUCT INFORMATION

#### Power

Elevated units offer undermount power beneath the seats, while plinth units offer flush mount power in the front. You can specify power units to be hardwired or equipped with a 3-prong plug. These units feature one USB-A port, one USB-C port, and a standard grounded 3-prong electrical outlet. Additional power options include daisy chain and wireless surface mount charging. Default cord lengths are 10 feet, with custom lengths available. Power units come with wire management clips for every 1-foot length of cord. Daisy chain infeeds are offered in 5', 10', and 15' standard lengths.

#### Mounting Options

Under mount power is designated by (U) in the model code. Flush mount power is designated by (F) in the model code.

#### Cord Length

Both the standard cord and the conduit whip are 10ft long. Other lengths are available as a custom order.

#### Colors

Under-mount power units are offered in black (B), gray (G), and white (W), while flush-mount power units are available in black (B) only.

#### Cable Management

All elevated units include cable mounts and screws for assembly and installation. Power units come with wire management clips for every 1-foot length of cord.

For plinth units against a wall, the rear-side toe kick can be removed to allow for cord egress.

For plinth units not against a wall, the unit may be raised up by extending the glides or the installer may cut a small mouse hole in the toe kick. See assembly instructions for more information.

#### Location

On elevated units, the power is located under the front edge, next to the leg. For plinth units, the power is flush to the front, positioned 8" on center from the side of the unit. However, for arm and armless units, the power is located 16" on center from that side. Units with a tapered front (Arm and Armless) under 45" in length cannot have power on the same side as the arm feature. For units 46" and longer, both left and right power options are available. Units with two arms under 45" in length cannot have power, and power is not available for corner or endcap units.

#### Order Entry

Please get in touch with [designapplication@stylexdesign.com](mailto:designapplication@stylexdesign.com). CET is required for order entry to determine jumper lengths and system configuration. All daisy chain units are entered under 1 line.

### To Order Select Below

#### 1. Power System

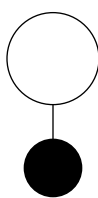

#### Power System

LNPSBS LUNA POWER SYSTEM **+2,039**

#### 2. Options

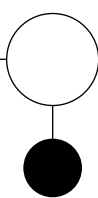

#### Options

UNDER MOUNT (ELEVATED) **+39**

FLUSH MOUNT (PLINTH) **+59**

JUMPER EXTENSION **+138**

# Luna

## SPECIFICATION GUIDE: DIMENSIONS, SEATING

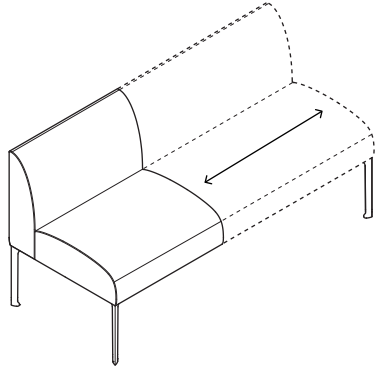
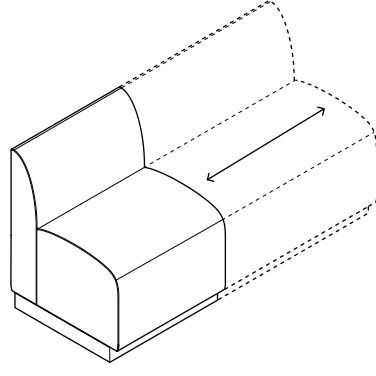
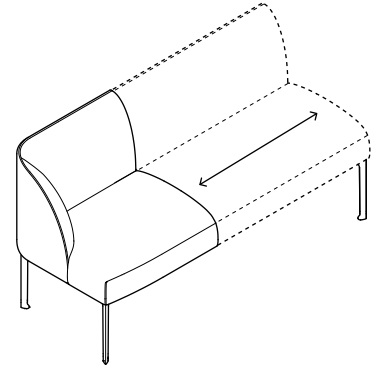
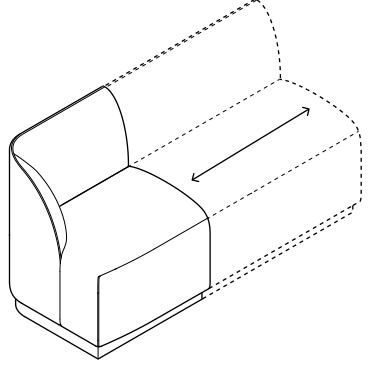
OVERVIEW		ELEVATED & PLINTH SEATING							
<p><b>Dimensions</b></p> <p>A. Overall Width            B. Overall Depth            C1. Overall Height Low Back            C2. Overall Height High Back            D. Seat Width            E. Seat Depth            F. Seat Height            G. Leg Height            H1. Back Height Low Back            H2. Back Height High Back</p> <p>Back and seat dimensions are based on compressed, seated dimensions.</p> <p>Elevated seating available without legs for customer's own millwork.</p>	 	<p><b>Standard</b></p> <p>A. 25 - 60            B. 25            C1. 31.5            C2. 38.5            D. 25 - 60            E. 19            F. 17.75            G. 12.25            H1. 13.75            H2. 20.75</p>	<p><b>Arm Left/Right</b></p> <p>A. 25 - 60            B. 25            C1. 31.5            C2. 38.5            D. 18 - 53            E. 19            F. 17.75            G. 12.25            H1. 13.75            H2. 20.75</p>	<p><b>Arm Both</b></p> <p>A. 30 - 60            B. 25            C1. 31.5            C2. 38.5            D. 16 - 46            E. 19            F. 17.75            G. 12.25            H1. 13.75            H2. 20.75</p>	<p><b>Armless End Left/Right</b></p> <p>A. 25 - 60            B. 25            C1. 31.5            C2. 38.5            D. 25 - 60            E. 19            F. 17.75            G. 12.25            H1. 13.75            H2. 20.75</p>	<p><b>Round Inside Corner</b></p> <p>A. 25            B. 25            C1. 31.5            C2. 38.5            D. 19            E. 19            F. 17.75            G. 12.25            H1. 13.75            H2. 20.75</p>	<p><b>Square Inside Corner</b></p> <p>A. 25            B. 25            C1. 31.5            C2. 38.5            D. 19            E. 19            F. 17.75            G. 12.25            H1. 13.75            H2. 20.75</p>	<p><b>Round Outside Corner</b></p> <p>A. 25            B. 25            C1. 31.5            C2. 38.5            D. 19            E. 19            F. 17.75            G. 12.25            H1. 13.75            H2. 20.75</p>	<p><b>Round End Cap</b></p> <p>A. 50 - 75            B. 25            C1. 31.5            C2. 38.5            D. 50 - 75            E. 19            F. 17.75            G. 12.25            H1. 13.75            H2. 20.75</p>
<p><b>Arm Choice</b></p> <p>A. Arm Width            B. Arm Depth</p>	 		<p><b>Arm Left/Right</b></p> <p>A. 7            B. 9</p>	<p><b>Arm Both</b></p> <p>A. 7            B. 9</p>					

# Luna

## SPECIFICATION GUIDE: DIMENSIONS, PLANTERS, TRAYS, TABLET

OVERVIEW	PLANTERS, FOR LOW BACK		PLANTERS, FOR HIGH BACK					
<p><b>Dimensions</b></p> <p>A. Width</p> <p>B. Depth</p> <p>C. Height</p>	<p><b>Single</b></p> <p>A. 15</p> <p>B. 15</p> <p>C. 31</p>		<p><b>Double</b></p> <p>A. 30</p> <p>B. 15</p> <p>C. 31</p>	<p><b>Single</b></p> <p>A. 15</p> <p>B. 15</p> <p>C. 38</p>	<p><b>Double</b></p> <p>A. 15</p> <p>B. 15</p> <p>C. 38</p>			
<p>A. Interior Height</p> <p>B. Interior Width (Top)</p> <p>C. Interior Width (Bottom)</p>	<p><b>Planter Liner</b></p> <p>A. 11.5</p> <p>B. 12.5</p> <p>C. 11.5</p>							
<p>A. Diameter</p> <p>B. Height Above Seat</p>	<p><b>Round Tray Table</b></p> <p>A. 13</p> <p>B. 2.5</p>	<p><b>Tablet Arm, Under Mount</b></p> <p>A. 14</p> <p>B. 8.5</p>	<p><b>Tablet Arm, Seat Mount</b></p> <p>A. 14</p> <p>B. 8.5</p>					
<p>A. Width</p> <p>B. Depth</p> <p>C. Height Above Seat</p>	<p><b>Wireless Charging Tray</b></p> <p>A. 8</p> <p>B. 13</p> <p>C. 3</p>							

# Luna

SPECIFICATION GUIDE: HOW TO ORDER, SEATING, ELEVATED

## MODEL CODE BREAKDOWN

Sample Model Code: LNE21L27DFSBBLUB12COM

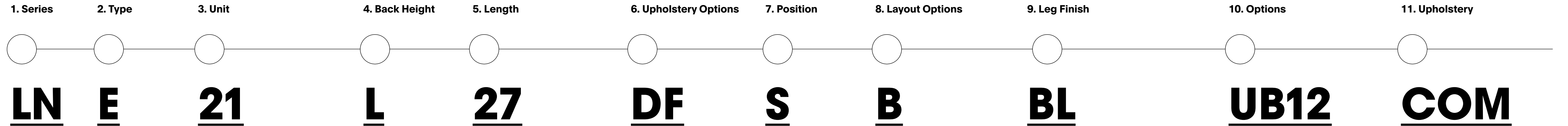

1. Series	2. Type	3. Unit	4. Back Height	5. Length	6. Upholstery Options	7. Position	8. Layout Options	9. Leg Finish	10. Options	11. Upholstery
<b>LN</b>	<b>E</b>	<b>21</b>	<b>L</b>	<b>27</b>	<b>DF</b>	<b>S</b>	<b>B</b>	<b>BL</b>	<b>UB12</b>	<b>COM</b>
<b>Series</b> LN LUNA	<b>Type</b> E ELEVATED	<b>Unit</b> 11 STANDARD 21 ARM LEFT 22 ARM RIGHT 23 ARM BOTH 31 ARMLESS END LEFT 32 ARMLESS END RIGHT 41 ROUND INSIDE CORNER 42 SQUARE INSIDE CORNER 51 ROUND OUTSIDE CORNER 52 ROUND END CAP	<b>Back Height</b> H HIGH BACK L LOW BACK	<b>Width</b> XX CUSTOM LENGTH 25 WIDTH (CORNERS)  Units available by the inch between 25 - 60" • 11 - STANDARD • 21 - ARM LEFT • 22 - ARM RIGHT • 31 - ARMLESS LEFT • 32 - ARMLESS RIGHT  Units available by the inch between 30 - 60" • 23 - ARM BOTH  Units available by the inch between 50 - 75" • 52 - ROUND END CAP  Units required to be 25" • 41 - ROUND INSIDE CORNER • 42 - SQUARE INSIDE CORNER • 51 - ROUND OUTSIDE CORNER	<b>Upholstery Options</b> DF DUAL UPHOLSTERY	<b>Position</b> F FREESTANDING S START M MID E END NL NO LEGS	<b>Layout Options</b> B BACK-TO-BACK  Back-to-back not available on mid units.  End units with arms cannot gang back-to-back via mid leg on the same side as the arm feature.	<b>Standard Powder Coated Metal</b> BL BLUE BM BLACK MATTE BR BRASS BT BLACK TWILIGHT CP CHAMPAGNE DB DARK BRONZE DG DARK GRAY DP DUSTY PINK FG FOREST GREEN LG LIGHT GRAY MG MEADOW GREEN MK MILK MS METALLIC SILVER NK NICKEL NV NAVY OR ORANGE PY PALE YELLOW RD RED RO RED ORANGE RR RUSTY RED SB SOFT BLUE SD SAND TC TERRACOTTA TP TAUPE TS TEXTURED SLATE YL YELLOW  <b>Other</b> AL POLISHED ALUMINUM	<b>Power Options</b> U___ UNDER MOUNT _B__ BLACK _G__ GRAY _W__ WHIT __H_ HARDWIRE ___1 POSITION 1 (LEFT) ___2 POSITION 2 (RIGHT)  <b>See power ordering options and rules.</b>  <b>Accessory Attachment</b> T TRAY/TABLET ARM ATTACHED TO UNIT  Accessory (tray table / tablet arm) attached to right side of seat unit. Not applicable for undermount tablet arms	<b>Textile Grades</b> COM CUSTOMER'S OWN MATERIAL A GRADE A B GRADE B C GRADE C D GRADE D E GRADE E F GRADE F G GRADE G H GRADE H I GRADE I J GRADE J K GRADE K L GRADE L M GRADE M  Note: Select highest grade in the case of dual upholstery

# Luna

SPECIFICATION GUIDE: HOW TO ORDER, SEATING, PLINTH

## MODEL CODE BREAKDOWN

Sample Model Code: LNP21L27DFSBLM05FB12COM

1. Series	2. Type	3. Unit	4. Back Height	5. Length	6. Upholstery Options	7. Position	8. Layout Options	9. Plinth Finish	10. Options	11. Upholstery
<b><u>LN</u></b>	<b><u>P</u></b>	<b><u>21</u></b>	<b><u>L</u></b>	<b><u>27</u></b>	<b><u>DF</u></b>	<b><u>S</u></b>	<b><u>B</u></b>	<b><u>LM05</u></b>	<b><u>UB12</u></b>	<b><u>COM</u></b>
<b>Series</b> LN LUNA	<b>Type</b> P PLINTH	<b>Unit</b> 11 STANDARD 21 ARM LEFT 22 ARM RIGHT 23 ARM BOTH 31 ARMLESS END LEFT 32 ARMLESS END RIGHT 41 ROUND INSIDE CORNER 42 SQUARE INSIDE CORNER 51 ROUND OUTSIDE CORNER 52 ROUND END CAP	<b>Back Height</b> H HIGH BACK L LOW BACK	<b>Width</b> XX CUSTOM LENGTH 25 WIDTH (CORNERS)  Units available by the inch between 25 - 60" • 11 - STANDARD • 21 - ARM LEFT • 22 - ARM RIGHT • 31 - ARMLESS LEFT • 32 - ARMLESS RIGHT  Units available by the inch between 30 - 60" • 23 - ARM BOTH  Units available by the inch between 50 - 75" • 52 - ROUND END CAP  Units required to be 25" • 41 - ROUND INSIDE CORNER • 42 - SQUARE INSIDE CORNER • 51 - ROUND OUTSIDE CORNER	<b>Upholstery Options</b> DF DUAL UPHOLSTERY	<b>Position</b> F FREESTANDING S START M MID E END NL NO LEGS	<b>Layout Options</b> B BACK-TO-BACK  Back-to-back not available on mid units.  End units with arms cannot gang back-to-back via mid leg on the same side as the arm feature.	<b>Plinth Toe Kick Finish</b> LM05 DOVE GRAY LM09 BLACK LM14 WALNUT HEIGHTS LM18 CASTLE OAK	<b>Power Options</b> F___ FLUSH MOUNT _B__ BLACK _G__ GRAY __H_ HARDWIRE ___1 POSITION 1 (LEFT) ___2 POSITION 2 (RIGHT)  <b>See power ordering options and rules.</b>  <b>Accessory Attachment</b> T TRAY/TABLET ARM ATTACHED TO UNIT  Accessory (tray table / tablet arm) attached to right side of seat unit. Not applicable for undermount tablet arms	<b>Textile Grades</b> COM CUSTOMER'S OWN MATERIAL A GRADE A B GRADE B C GRADE C D GRADE D E GRADE E F GRADE F G GRADE G H GRADE H I GRADE I J GRADE J K GRADE K L GRADE L M GRADE M  Note: Select highest grade in the case of dual upholstery

# Luna

SPECIFICATION GUIDE: HOW TO ORDER, TRAY AND TABLET

---

## MODEL CODE BREAKDOWN

---

Sample Model Code: LNE72SW81BM

1. Series

2. Type

3. Top Finish

4. Finish

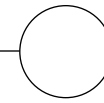
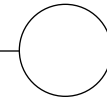
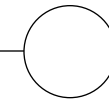
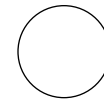

**LN** **72**

**SW81**

**BM**

### Series

LN LUNA

### Type

- 71 ROUND TRAY TABLE
- 72 WIRELESS CHARGING TRAY
- 75 TABLET ARM, UNDER MOUNT SINGLE SWIVEL
- 76 TABLET ARM, UNDER MOUNT DUAL SWIVEL
- 77 TABLET ARM, SEAT MOUNT SINGLE SWIVEL
- 78 TABLET ARM, SEAT MOUNT DUAL SWIVEL

### Wood Finish

- SW81 WHITE OAK
- SW83 MAPLE
- SW85 WALNUT
- SW87 OPAQUE BLACK

Not applicable for Round Table Tray

### Standard Powder Coated Metal

- BL BLUE
- BM BLACK MATTE
- BR BRASS
- BT BLACK TWILIGHT
- CP CHAMPAGNE
- DB DARK BRONZE
- DG DARK GRAY
- DP DUSTY PINK
- FG FOREST GREEN
- LG LIGHT GRAY
- MG MEADOW GREEN
- MK MILK
- MS METALLIC SILVER
- NK NICKEL
- NV NAVY
- OR ORANGE
- PY PALE YELLOW
- RD RED
- RO RED ORANGE
- RR RUSTY RED
- SB SOFT BLUE
- SD SAND
- TC TERRACOTTA
- TP TAUPE
- TS TEXTURED SLATE
- YL YELLOW

Not applicable for Wireless Charging Tray



# Luna

SPECIFICATION GUIDE: HOW TO ORDER, PLANTER

---

## MODEL CODE BREAKDOWN

---

Sample Model Code: LN6P2ABLM09

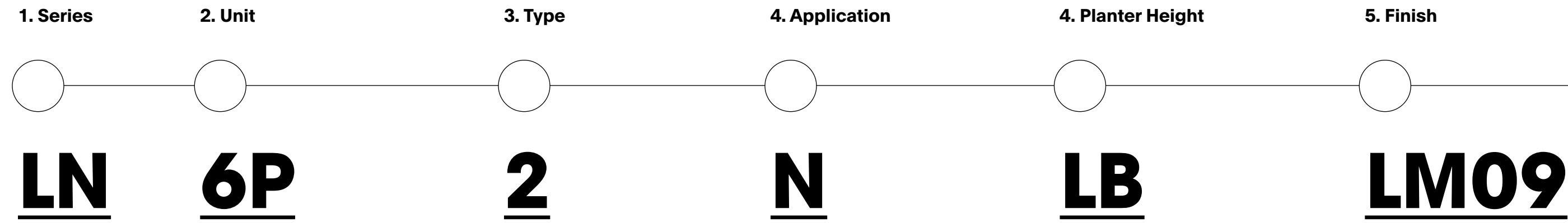

**Series**  
LN LUNA

**Unit**  
6P PLANTER

**Type**  
1 SINGLE  
2 DOUBLE

**Application**  
A ENCLOSED  
B EXPOSED

Enclosed planters (A) are not designed to be exposed, they must be surrounded by seating units. They utilize a butt-joint construction. Exposed planters (B) can be specified in any application and use a miter-joint construction.

**Back Height**  
LB LOW BACK  
HB HIGH BACK

**Finish**  
LM05 DOVE GRAY  
LM09 BLACK  
LM14 WALNUT HEIGHTS  
LM18 CASTLE OAK  
WV46 NATURAL FLAT CUT WALNUT  
WV48 NATURAL WHITE OAK

Black Laminate, LM09 is the only available planter finish for Enclosed planters.

# Luna

COLORS, MATERIALS, AND FINISHES

## POWDER COATED PAINTED METAL



## SOLID WOOD



## LAMINATE



## WOOD VENEER



# Luna

ELEVATED: STANDARD

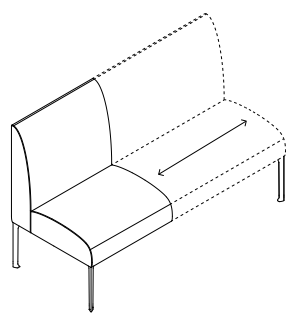
	WIDTHS	SERIES	TYPE	UNIT	BACK HEIGHT	DIMENSIONS	Yardage Requirements			Textile Upholstery Grades														
							SEAT	BACK	BACK/SEAT	COM	A	B	C	D	E	F	G	H	I	J	K	L	M	
 <p><b>Elevated, Standard, Low Back</b></p>	25-30in Wide	LN	E	11	L	25-30W x 25D x 31H	1	1.3	2.2	2,002	2,155	2,241	2,326	2,412	2,498	2,592	2,684	2,795	2,928	3,083	3,247	3,406	3,559	
	31-35in Wide	LN	E	11	L	31-35W x 25D x 31H	1.3	1.4	2.6	2,205	2,381	2,480	2,578	2,676	2,776	2,884	2,989	3,117	3,269	3,448	3,637	3,819	3,996	
	36-40in Wide	LN	E	11	L	36-40W x 25D x 31H	1.4	1.6	2.8	2,408	2,600	2,707	2,813	2,920	3,028	3,146	3,260	3,399	3,565	3,759	3,964	4,162	4,354	
	41-45in Wide	LN	E	11	L	41-45W x 25D x 31H	1.5	1.7	3.1	2,611	2,825	2,946	3,064	3,185	3,305	3,437	3,565	3,721	3,907	4,124	4,354	4,576	4,791	
	46-50in Wide	LN	E	11	L	46-50W x 25D x 31H	1.7	1.9	3.5	2,814	3,051	3,185	3,316	3,449	3,583	3,729	3,871	4,043	4,248	4,490	4,744	4,989	5,227	
	51-55in Wide	LN	E	11	L	51-55W x 25D x 31H	1.8	2	3.8	3,017	3,277	3,424	3,568	3,714	3,860	4,020	4,176	4,365	4,590	4,855	5,133	5,403	5,664	
	56-60in Wide	LN	E	11	L	56-60W x 25D x 31H	2	2.2	4.1	3,220	3,503	3,663	3,819	3,978	4,138	4,312	4,481	4,687	4,932	5,220	5,523	5,816	6,100	
 <p><b>Elevated, Standard, High Back</b></p>	25-30in Wide	LN	E	11	H	25-30W x 25D x 38H	1	2.1	3	2,118	2,325	2,441	2,555	2,671	2,788	2,915	3,038	3,188	3,367	3,577	3,799	4,013	4,220	
	31-35in Wide	LN	E	11	H	31-35W x 25D x 38H	1.3	2.4	3.5	2,327	2,564	2,698	2,829	2,962	3,096	3,242	3,384	3,556	3,761	4,003	4,257	4,502	4,740	
	36-40in Wide	LN	E	11	H	36-40W x 25D x 38H	1.4	2.7	4	2,535	2,811	2,966	3,118	3,273	3,428	3,597	3,762	3,962	4,201	4,481	4,776	5,061	5,337	
	41-45in Wide	LN	E	11	H	41-45W x 25D x 38H	1.5	3	4.4	2,743	3,049	3,221	3,391	3,562	3,735	3,923	4,106	4,328	4,594	4,905	5,233	5,550	5,857	
	46-50in Wide	LN	E	11	H	46-50W x 25D x 38H	1.7	2.7	4.3	2,952	3,250	3,418	3,583	3,751	3,919	4,103	4,281	4,498	4,756	5,060	5,380	5,689	5,988	
	51-55in Wide	LN	E	11	H	51-55W x 25D x 38H	1.8	3	4.7	3,160	3,481	3,662	3,840	4,020	4,201	4,399	4,591	4,825	5,103	5,430	5,774	6,107	6,429	
	56-60in Wide	LN	E	11	H	56-60W x 25D x 38H	2	3.2	5.1	3,368	3,720	3,918	4,113	4,310	4,509	4,725	4,936	5,191	5,496	5,854	6,231	6,596	6,949	

To Order Select Below

<p><b>1. Series/Type/Unit</b></p> <p>LNE11</p> <p><b>Luna Elevated Standard</b></p>	<p><b>2. Back Height</b></p> <p>H HIGH BACK</p> <p>L LOW BACK</p>	<p><b>3. Width</b></p> <p>XX WIDTH</p> <p>Available in 25-60"</p>	<p><b>4. Upholstery Options</b></p> <p>DF DUAL UPHOLSTERY</p>	<p><b>5. Postion</b></p> <p>F FREESTANDING</p> <p>S START</p> <p>M MID</p> <p>E END</p> <p>NL NO LEGS</p>	<p><b>6. Layout Options</b></p> <p>B BACK-TO-BACK</p> <p>Back-to-back not available on mid units.</p>	<p><b>7. Leg Finish</b></p> <p><b>Standard Powder Coated Metal</b></p> <p>BL BLUE</p> <p>BM BLACK MATTE</p> <p>BR BRASS</p> <p>BT BLACK TWILIGHT</p> <p>CP CHAMPAGNE</p> <p>DB DARK BRONZE</p> <p>DG DARK GRAY</p> <p>DP DUSTY PINK</p> <p>FG FOREST GREEN</p> <p>LG LIGHT GRAY</p> <p>MG MEADOW GREEN</p> <p>MK MILK</p> <p>MS METALLIC SILVER</p> <p><b>Polished Metal</b></p> <p>AL POLISHED ALUMINUM</p>	<p><b>8. Options</b></p> <p><b>Power Options</b></p> <p><b>See under mount power ordering options and rules.</b></p> <p><b>Accessory Attachment</b></p> <p>T TRAY/TABLET ARM ATTACHED TO UNIT</p> <p>Accessory attaches to right side of seat unit. Trays and tablet arm seat mount units can only be used between units.</p>	<p><b>9. Upholstery</b></p> <p><b>See general information section for details on textile program and COM information.</b></p>
---	---	---	---	---	---	--	---	---

# Luna

ELEVATED: ARM LEFT OR RIGHT

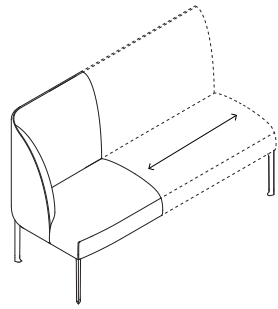
	WIDTHS	SERIES	TYPE	UNIT	BACK HEIGHT	DIMENSIONS	Yardage Requirements			Textile Upholstery Grades														
							SEAT	BACK	BACK/SEAT	COM	A	B	C	D	E	F	G	H	I	J	K	L	M	
 <p><b>Elevated, Arm Left/Right, Low Back</b></p>	25-30in Wide	LN	E	21/22	L	25-30W x 25D x 31H	1.3	1.4	2.6	2,474	2,650	2,749	2,847	2,945	3,045	3,153	3,258	3,386	3,538	3,717	3,906	4,088	4,265	
	31-35in Wide	LN	E	21/22	L	31-35W x 25D x 31H	1.5	1.6	2.9	2,679	2,878	2,990	3,100	3,212	3,324	3,446	3,565	3,710	3,882	4,084	4,298	4,504	4,703	
	36-40in Wide	LN	E	21/22	L	36-40W x 25D x 31H	1.6	1.7	3.2	2,884	3,106	3,231	3,354	3,478	3,603	3,740	3,872	4,034	4,226	4,451	4,689	4,919	5,142	
	41-45in Wide	LN	E	21/22	L	41-45W x 25D x 31H	1.6	1.9	3.3	3,089	3,326	3,460	3,591	3,724	3,858	4,004	4,146	4,318	4,523	4,765	5,019	5,264	5,502	
	46-50in Wide	LN	E	21/22	L	46-50W x 25D x 31H	1.7	1.9	3.5	3,294	3,524	3,653	3,780	3,909	4,038	4,179	4,317	4,483	4,682	4,915	5,161	5,399	5,629	
	51-55in Wide	LN	E	21/22	L	51-55W x 25D x 31H	1.7	2	3.6	3,499	3,744	3,882	4,017	4,155	4,293	4,443	4,590	4,767	4,980	5,229	5,491	5,745	5,990	
	56-60in Wide	LN	E	21/22	L	56-60W x 25D x 31H	1.8	2.1	3.9	3,703	3,971	4,122	4,270	4,420	4,571	4,736	4,896	5,090	5,322	5,595	5,882	6,159	6,427	
 <p><b>Elevated, Arm Left/Right, High Back</b></p>	25-30in Wide	LN	E	21/22	H	25-30W x 25D x 38H	1.3	1.8	3	2,675	2,882	2,998	3,112	3,228	3,345	3,472	3,595	3,745	3,924	4,134	4,356	4,570	4,777	
	31-35in Wide	LN	E	21/22	H	31-35W x 25D x 38H	1.5	2.1	3.5	2,886	3,123	3,257	3,388	3,521	3,655	3,801	3,943	4,115	4,320	4,562	4,816	5,061	5,299	
	36-40in Wide	LN	E	21/22	H	36-40W x 25D x 38H	1.6	2.4	3.9	3,096	3,364	3,515	3,663	3,813	3,964	4,129	4,289	4,483	4,715	4,988	5,275	5,552	5,820	
	41-45in Wide	LN	E	21/22	H	41-45W x 25D x 38H	1.7	2.7	4.3	3,306	3,604	3,772	3,937	4,105	4,273	4,457	4,635	4,852	5,110	5,414	5,734	6,043	6,342	
	46-50in Wide	LN	E	21/22	H	46-50W x 25D x 38H	1.6	2.2	3.7	3,516	3,769	3,911	4,050	4,192	4,334	4,490	4,641	4,824	5,043	5,300	5,570	5,832	6,085	
	51-55in Wide	LN	E	21/22	H	51-55W x 25D x 38H	1.7	2.4	4	3,726	4,002	4,157	4,309	4,464	4,619	4,788	4,953	5,153	5,392	5,672	5,967	6,252	6,528	
	56-60in Wide	LN	E	21/22	H	56-60W x 25D x 38H	1.8	2.6	4.3	3,936	4,234	4,402	4,567	4,735	4,903	5,087	5,265	5,482	5,740	6,044	6,364	6,673	6,972	

To Order Select Below

<p><b>1. Series/Type/Unit</b></p> <p>LUNA ELEVATED ARM LEFT LNE21</p> <p>LUNA ELEVATED ARM RIGHT LNE22</p> <p>Elevated Arm Right shown above</p>	<p><b>2. Back Height</b></p> <p>H HIGH BACK</p> <p>L LOW BACK</p>	<p><b>3. Length</b></p> <p>XX LENGTH</p> <p>Available in 25-60"</p>	<p><b>4. Upholstery Options</b></p> <p>DF DUAL UPHOLSTERY</p>	<p><b>5. Postion</b></p> <p>F FREESTANDING</p> <p>S START</p> <p>E END</p> <p>NL NO LEGS</p>	<p><b>6. Leg Finish</b></p> <p><b>Standard Powder Coated Metal</b></p> <p>BL BLUE</p> <p>BM BLACK MATTE</p> <p>BR BRASS</p> <p>BT BLACK TWILIGHT</p> <p>CP CHAMPAGNE</p> <p>DB DARK BRONZE</p> <p>DG DARK GRAY</p> <p>DP DUSTY PINK</p> <p>FG FOREST GREEN</p> <p>LG LIGHT GRAY</p> <p>MG MEADOW GREEN</p> <p>MK MILK</p> <p>MS METALLIC SILVER</p> <p><b>Polished Metal</b></p> <p>AL POLISHED ALUMINUM</p>	<p><b>7. Options</b></p> <p><b>Power Options</b></p> <p>See under mount power ordering options and rules.</p> <p><b>Accessory Attachment</b></p> <p>T TRAY/TABLET ARM ATTACHED TO UNIT</p> <p>Accessory attaches to right side of seat unit. Trays and tablet arm seat mount units can only be used between units. Not available on Arm Right Units.</p>	<p><b>8. Upholstery</b></p> <p>See general information section for details on textile program and COM information.</p>
--	---	---	---	--	--	--	--

# Luna

ELEVATED: ARM BOTH

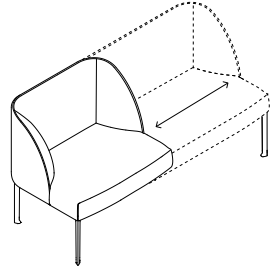
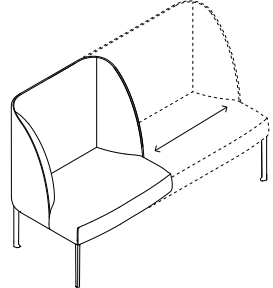
	WIDTHS	SERIES	TYPE	UNIT	BACK HEIGHT	DIMENSIONS	Yardage Requirements			Textile Upholstery Grades														
							SEAT	BACK	BACK/SEAT	COM	A	B	C	D	E	F	G	H	I	J	K	L	M	
 <p><b>Elevated, Arm Both, Low Back</b></p>	30-35in Wide	LN	E	23	L	30-35W x 25D x 31H	1.7	1.9	3.5	3,103	3,340	3,474	3,605	3,738	3,872	4,018	4,160	4,332	4,537	4,779	5,033	5,278	5,516	
	36-40in Wide	LN	E	23	L	36-40W x 25D x 31H	1.8	2	3.8	3,311	3,571	3,718	3,862	4,008	4,154	4,314	4,470	4,659	4,884	5,149	5,427	5,697	5,958	
	41-45in Wide	LN	E	23	L	41-45W x 25D x 31H	2	2.2	4.1	3,519	3,802	3,962	4,118	4,277	4,437	4,611	4,780	4,986	5,231	5,519	5,822	6,115	6,399	
	46-50in Wide	LN	E	23	L	46-50W x 25D x 31H	1.6	2.1	3.6	3,727	3,972	4,110	4,245	4,383	4,521	4,671	4,818	4,995	5,208	5,457	5,719	5,973	6,218	
	51-55in Wide	LN	E	23	L	51-55W x 25D x 31H	1.7	2.2	3.9	3,935	4,203	4,354	4,502	4,652	4,803	4,968	5,128	5,322	5,554	5,827	6,114	6,391	6,659	
	56-60in Wide	LN	E	23	L	56-60W x 25D x 31H	1.8	2.4	4.1	4,143	4,426	4,586	4,742	4,901	5,061	5,235	5,404	5,610	5,855	6,143	6,446	6,739	7,023	
 <p><b>Elevated, Arm Both, High Back</b></p>	30-35in Wide	LN	E	23	H	30-35W x 25D x 38H	1.7	2	3.7	3,390	3,643	3,785	3,924	4,066	4,208	4,364	4,515	4,698	4,917	5,174	5,444	5,706	5,959	
	36-40in Wide	LN	E	23	H	36-40W x 25D x 38H	1.8	2.2	4	3,603	3,879	4,034	4,186	4,341	4,496	4,665	4,830	5,030	5,269	5,549	5,844	6,129	6,405	
	41-45in Wide	LN	E	23	H	41-45W x 25D x 38H	2	2.4	4.3	3,817	4,115	4,283	4,448	4,616	4,784	4,968	5,146	5,363	5,621	5,925	6,245	6,554	6,853	
	46-50in Wide	LN	E	23	H	46-50W x 25D x 38H	1.6	2.6	4	4,030	4,306	4,461	4,613	4,768	4,923	5,092	5,257	5,457	5,696	5,976	6,271	6,556	6,832	
	51-55in Wide	LN	E	23	H	51-55W x 25D x 38H	1.7	2.8	4.3	4,244	4,542	4,710	4,875	5,043	5,211	5,395	5,573	5,790	6,048	6,352	6,672	6,981	7,280	
	56-60in Wide	LN	E	23	H	56-60W x 25D x 38H	1.8	2.9	4.7	4,457	4,778	4,959	5,137	5,317	5,498	5,696	5,888	6,122	6,400	6,727	7,071	7,404	7,726	

**To Order Select Below**

<p><b>1. Series/Type/Unit</b></p> <p>LNE23</p> <p><b>Luna Elevated Arm Both</b></p>	<p><b>2. Back Height</b></p> <p>H HIGH BACK L LOW BACK</p>	<p><b>3. Length</b></p> <p>XX LENGTH</p> <p>Available in 30-60"</p>	<p><b>4. Upholstery Options</b></p> <p>DF DUAL UPHOLSTERY</p>	<p><b>5. Postion</b></p> <p>F FREESTANDING NL NO LEGS</p>	<p><b>6. Layout Options</b></p> <p>B BACK-TO-BACK</p> <p>Back-to-back not available on mid units.</p> <p>End units with arms cannot gang back-to-back via mid leg on the same side as the arm feature.</p>	<p><b>7. Leg Finish</b></p> <p><b>Standard Powder Coated Metal</b></p> <p>BL BLUE BM BLACK MATTE BR BRASS BT BLACK TWILIGHT CP CHAMPAGNE DB DARK BRONZE DG DARK GRAY DP DUSTY PINK FG FOREST GREEN LG LIGHT GRAY MG MEADOW GREEN MK MILK MS METALLIC SILVER</p> <p><b>Polished Metal</b></p> <p>AL POLISHED ALUMINUM</p>	<p><b>8. Options</b></p> <p><b>Power Options</b></p> <p><b>See under mount power ordering options and rules.</b></p>	<p><b>9. Upholstery</b></p> <p><b>See general information section for details on textile program and COM information</b></p>
---	--	---	---	---	--	--	--	--

# Luna

ELEVATED: ARMLESS LEFT OR RIGHT

	WIDTHS	SERIES	TYPE	UNIT	BACK HEIGHT	DIMENSIONS	Yardage Requirements			Textile Upholstery Grades														
							SEAT	BACK	BACK/SEAT	COM	A	B	C	D	E	F	G	H	I	J	K	L	M	
	Elevated, Armless End Left/Right, Low Back	25-30in Wide	LN	E	31/32	L	25-30W x 25D x 31H	1.3	1.3	2.5	2,119	2,288	2,382	2,475	2,570	2,665	2,768	2,869	2,991	3,137	3,308	3,489	3,663	3,832
	31-35in Wide	LN	E	31/32	L	31-35W x 25D x 31H	1.5	1.4	2.8	2,322	2,514	2,621	2,727	2,834	2,942	3,060	3,174	3,313	3,479	3,673	3,878	4,076	4,268	
	36-40in Wide	LN	E	31/32	L	36-40W x 25D x 31H	1.6	1.6	3.1	2,525	2,739	2,860	2,978	3,099	3,219	3,351	3,479	3,635	3,821	4,038	4,268	4,490	4,705	
	41-45in Wide	LN	E	31/32	L	41-45W x 25D x 31H	1.7	1.7	3.3	2,728	2,958	3,087	3,214	3,343	3,472	3,613	3,751	3,917	4,116	4,349	4,595	4,833	5,063	
	46-50in Wide	LN	E	31/32	L	46-50W x 25D x 31H	1.7	1.9	3.5	2,931	3,168	3,302	3,433	3,566	3,700	3,846	3,988	4,160	4,365	4,607	4,861	5,106	5,344	
	51-55in Wide	LN	E	31/32	L	51-55W x 25D x 31H	1.8	2	3.8	3,134	3,394	3,541	3,685	3,831	3,977	4,137	4,293	4,482	4,707	4,972	5,250	5,520	5,781	
	56-60in Wide	LN	E	31/32	L	56-60W x 25D x 31H	2	2.1	4.1	3,337	3,620	3,780	3,936	4,095	4,255	4,429	4,598	4,804	5,049	5,337	5,640	5,933	6,217	
	Elevated, Armless End Left/Right, High	25-30in Wide	LN	E	31/32	H	25-30W x 25D x 38H	1.3	2.1	3.3	2,240	2,470	2,599	2,726	2,855	2,984	3,125	3,263	3,429	3,628	3,861	4,107	4,345	4,575
	31-35in Wide	LN	E	31/32	H	31-35W x 25D x 38H	1.5	2.5	3.8	2,449	2,709	2,856	3,000	3,146	3,292	3,452	3,608	3,797	4,022	4,287	4,565	4,835	5,096	
	36-40in Wide	LN	E	31/32	H	36-40W x 25D x 38H	1.6	2.8	4.3	2,657	2,955	3,123	3,288	3,456	3,624	3,808	3,986	4,203	4,461	4,765	5,085	5,394	5,693	
	41-45in Wide	LN	E	31/32	H	41-45W x 25D x 38H	1.7	3.1	4.8	2,865	3,194	3,379	3,561	3,746	3,931	4,134	4,330	4,569	4,854	5,189	5,541	5,882	6,212	
	46-50in Wide	LN	E	31/32	H	46-50W x 25D x 38H	1.7	2.7	4.2	3,074	3,365	3,528	3,689	3,852	4,016	4,195	4,369	4,580	4,832	5,128	5,439	5,741	6,032	
	51-55in Wide	LN	E	31/32	H	51-55W x 25D x 38H	1.8	2.9	4.7	3,282	3,603	3,784	3,962	4,142	4,323	4,521	4,713	4,947	5,225	5,552	5,896	6,229	6,551	
	56-60in Wide	LN	E	31/32	H	56-60W x 25D x 38H	2	3.1	5	3,490	3,834	4,028	4,219	4,412	4,606	4,818	5,024	5,274	5,572	5,922	6,291	6,648	6,993	

To Order Select Below

<p><b>1. Series/Type/Unit</b></p> <p>LUNA ELEVATED ARMLESS LEFT LNE31</p> <p>LUNA ELEVATED ARMLESS RIGHT LNE32</p> <p>Elevated Armless Right shown above</p>	<p><b>2. Back Height</b></p> <p>H HIGH BACK L LOW BACK</p>	<p><b>3. Width</b></p> <p>XX WIDTH</p> <p>Available in 25-60"</p>	<p><b>4. Upholstery Options</b></p> <p>DF DUAL UPHOLSTERY</p>	<p><b>5. Position</b></p> <p>F FREESTANDING S START E END NL NO LEGS</p>	<p><b>6. Layout Options</b></p> <p>B BACK-TO-BACK</p> <p>Back-to-back not available on mid units.</p>	<p><b>7. Leg Finish</b></p> <p><b>Standard Powder Coated Metal</b></p> <p>BL BLUE BM BLACK MATTE BR BRASS BT BLACK TWILIGHT CP CHAMPAGNE DB DARK BRONZE DG DARK GRAY DP DUSTY PINK FG FOREST GREEN LG LIGHT GRAY MG MEADOW GREEN MK MILK MS METALLIC SILVER</p> <p><b>Polished Metal</b></p> <p>AL POLISHED ALUMINUM</p>	<p><b>8. Options</b></p> <p><b>Power Options</b></p> <p>See under mount power ordering options and rules.</p> <p><b>Accessory Attachment</b></p> <p>T TRAY/TABLET ARM ATTACHED TO UNIT</p> <p>Accessory attaches to right side of seat unit. Trays and tablet arm seat mount units can only be used between units. Not available on Armless Right Units.</p>	<p><b>9. Upholstery</b></p> <p>See general information section for details on textile program and COM information.</p>
--	--	---	---	--	---	--	--	--

# Luna

ELEVATED: ROUND INSIDE CORNER

	WIDTH	SERIES	TYPE	UNIT	BACK HEIGHT	DIMENSIONS	Yardage Requirements			Textile Upholstery Grades													
							SEAT	BACK	BACK/SEAT	COM	A	B	C	D	E	F	G	H	I	J	K	L	M
 <p><b>Elevated, Round Inside Corner, Low Back</b></p>	25	LN	E	41	L	25W x 25D x 31H	0.8	1.7	2.4	2,238	2,399	2,489	2,578	2,668	2,759	2,858	2,954	3,071	3,210	3,373	3,545	3,712	3,873
 <p><b>Elevated, Round Inside Corner, High Back</b></p>	25	LN	E	41	H	25W x 25D x 38H	0.8	2.6	3.2	2,453	2,675	2,800	2,923	3,047	3,172	3,309	3,441	3,603	3,795	4,020	4,258	4,488	4,711

**To Order Select Below**

**1. Series/Type/Unit**

○

●

---

LNE41

---

**Luna**  
Elevated  
Round Inside Corner

**2. Back Height**

○

● **Back Height**

---

H HIGH BACK

---

L LOW BACK

**3. Width**

○

● **Width**

---

25 WIDTH

**4. Upholstery Options**

○

● **Upholstery Options**

---

DF DUAL UPHOLSTERY

**5. Position**

○

● **Position**

---

M MID

---

NL NO LEGS

**6. Leg Finish**

○

● **Standard Powder Coated Metal**

---

BL BLUE

---

BM BLACK MATTE

---

BR BRASS

---

BT BLACK TWILIGHT

---

CP CHAMPAGNE

---

DB DARK BRONZE

---

DG DARK GRAY

---

DP DUSTY PINK

---

FG FOREST GREEN

---

LG LIGHT GRAY

---

MG MEADOW GREEN

---

MK MILK

---

MS METALLIC SILVER

---

NK NICKEL

---

NV NAVY

---

OR ORANGE

---

PY PALE YELLOW

---

RD RED

---

RO RED ORANGE

---

RR RUSTY RED

---

SB SOFT BLUE

---

SD SAND

---

TC TERRACOTTA

---

TP TAUPE

---

TS TEXTURED SLATE

---

YL YELLOW

---

● **Polished Metal**

---

AL POLISHED ALUMINUM

**7. Upholstery**

○

● **See general information section for details on textile program and COM information**

# Luna

ELEVATED: SQUARE INSIDE CORNER

	WIDTH	SERIES	TYPE	UNIT	BACK HEIGHT	DIMENSIONS	Yardage Requirements			Textile Upholstery Grades													
							SEAT	BACK	BACK/SEAT	COM	A	B	C	D	E	F	G	H	I	J	K	L	M
 <p><b>Elevated, Square Inside Corner, Low Back</b></p>	25	LN	E	42	L	25W x 25D x 31H	0.8	1.7	2.4	2,208	2,369	2,459	2,548	2,638	2,729	2,828	2,924	3,041	3,180	3,343	3,515	3,682	3,843
 <p><b>Elevated, Square Inside Corner, High Back</b></p>	25	LN	E	42	H	25W x 25D x 38H	0.8	2.7	3.3	2,364	2,594	2,723	2,850	2,979	3,108	3,249	3,387	3,553	3,752	3,985	4,231	4,469	4,699

**To Order Select Below**

**1. Series/Type/Unit**

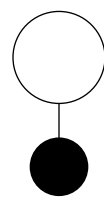

LNE42

**Luna**  
Elevated  
Square Inside Corner

**2. Back Height**

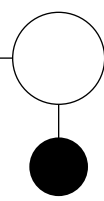

**Back Height**

H HIGH BACK

L LOW BACK

**3. Width**

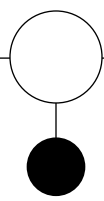

**Width**

25 WIDTH

**4. Upholstery Options**

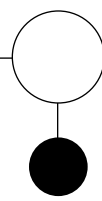

**Upholstery Options**

DF DUAL UPHOLSTERY

**5. Position**

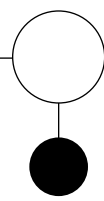

**Position**

M MID

NL NO LEGS

**6. Leg Finish**

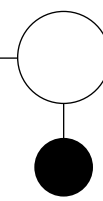

**Standard Powder Coated Metal**

BL BLUE

BM BLACK MATTE

BR BRASS

BT BLACK TWILIGHT

CP CHAMPAGNE

DB DARK BRONZE

DG DARK GRAY

DP DUSTY PINK

FG FOREST GREEN

LG LIGHT GRAY

MG MEADOW GREEN

MK MILK

MS METALLIC SILVER

NK NICKEL

NV NAVY

OR ORANGE

PY PALE YELLOW

RD RED

RO RED ORANGE

RR RUSTY RED

SB SOFT BLUE

SD SAND

TC TERRACOTTA

TP TAUPE

TS TEXTURED SLATE

YL YELLOW

**Polished Metal**

AL POLISHED ALUMINUM

**7. Upholstery**

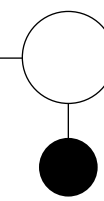

**See general information section for details on textile program and COM information**



# Luna

ELEVATED: ROUND OUTSIDE CORNER

	WIDTH	SERIES	TYPE	UNIT	BACK HEIGHT	DIMENSIONS	Yardage Requirements			Textile Upholstery Grades													
							SEAT	BACK	BACK/SEAT	COM	A	B	C	D	E	F	G	H	I	J	K	L	M
 <p><b>Elevated, Round Outside Corner, Low Back</b></p>	25	LN	E	51	L	25W x 25D x 31H	1.4	0.5	1.8	1,452	1,575	1,644	1,711	1,780	1,849	1,924	1,998	2,086	2,193	2,317	2,448	2,575	2,698
 <p><b>Elevated, Round Outside Corner, High Back</b></p>	25	LN	E	51	H	25W x 25D x 38H	1.4	0.5	1.8	1,563	1,686	1,755	1,822	1,891	1,960	2,035	2,109	2,197	2,304	2,428	2,559	2,686	2,809

**To Order Select Below**

**1. Series/Type/Unit**

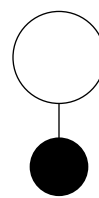

LNE51  
**Luna Elevated Round Outside Corner**

**2. Back Height**

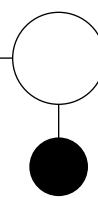

**Back Height**  
H HIGH BACK  
L LOW BACK

**3. Width**

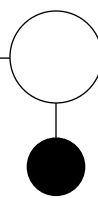

**Width**  
25 WIDTH

**4. Upholstery Options**

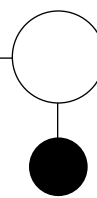

**Upholstery Options**  
DF DUAL UPHOLSTERY

**5. Postion**

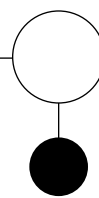

**Position**  
M MID  
NL NO LEGS

**6. Leg Finish**

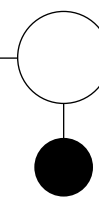

**Standard Powder Coated Metal**

BL	BLUE	NK	NICKEL
BM	BLACK MATTE	NV	NAVY
BR	BRASS	OR	ORANGE
BT	BLACK TWILIGHT	PY	PALE YELLOW
CP	CHAMPAGNE	RD	RED
DB	DARK BRONZE	RO	RED ORANGE
DG	DARK GRAY	RR	RUSTY RED
DP	DUSTY PINK	SB	SOFT BLUE
FG	FOREST GREEN	SD	SAND
LG	LIGHT GRAY	TC	TERRACOTTA
MG	MEADOW GREEN	TP	TAUPE
MK	MILK	TS	TEXTURED SLATE
MS	METALLIC SILVER	YL	YELLOW

**Polished Metal**

AL	POLISHED ALUMINUM
----	-------------------

**7. Options**

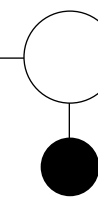

**Accessory Attachment**  
T TRAY/TABLET ARM ATTACHED TO UNIT

Accessory attaches to right side of seat unit. Trays and tablet arm seat mount units can only be used between units

**8. Upholstery**

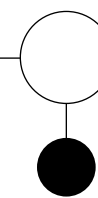

**See general information section for details on textile program and COM information**

# Luna

ELEVATED: ROUND END CAP

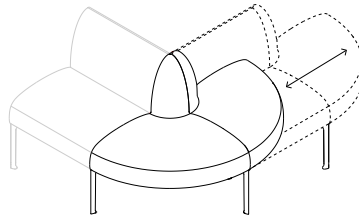
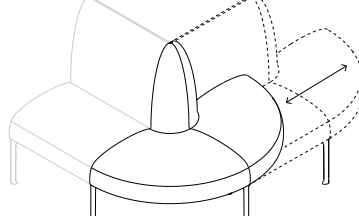
	WIDTHS	SERIES	TYPE	UNIT	BACK HEIGHT	DIMENSIONS	Yardage Requirements			Textile Upholstery Grades														
							SEAT	BACK	BACK/SEAT	COM	A	B	C	D	E	F	G	H	I	J	K	L	M	
	Elevated, Round End Cap, Low Back	50-55in Wide	LN	E	52	L	50-55W x 25D x 31H	1.9	0.7	2.6	2,859	3,035	3,134	3,232	3,330	3,430	3,538	3,643	3,771	3,923	4,102	4,291	4,473	4,650
	56-60in Wide	LN	E	52	L	56-60W x 25D x 31H	1.9	0.8	2.7	2,974	3,158	3,261	3,363	3,466	3,569	3,682	3,792	3,925	4,085	4,271	4,468	4,658	4,842	
	61-65in Wide	LN	E	52	L	61-65W x 25D x 31H	2	1	3	3,088	3,295	3,411	3,525	3,641	3,758	3,885	4,008	4,158	4,337	4,547	4,769	4,983	5,190	
	66-70in Wide	LN	E	52	L	66-70W x 25D x 31H	2.1	1.1	3.2	3,203	3,425	3,550	3,673	3,797	3,922	4,059	4,191	4,353	4,545	4,770	5,008	5,238	5,461	
	71-75in Wide	LN	E	52	L	71-75W x 25D x 31H	2.2	1.4	3.6	3,317	3,562	3,700	3,835	3,973	4,111	4,261	4,408	4,585	4,798	5,047	5,309	5,563	5,808	
	Elevated, Round End Cap, High Back	50-55in Wide	LN	E	52	H	50-55W x 25D x 38H	1.9	0.9	2.8	2,941	3,133	3,240	3,346	3,453	3,561	3,679	3,793	3,932	4,098	4,292	4,497	4,695	4,887
	56-60in Wide	LN	E	52	H	56-60W x 25D x 38H	1.9	1	2.9	3,052	3,251	3,363	3,473	3,585	3,697	3,819	3,938	4,083	4,255	4,457	4,671	4,877	5,076	
	61-65in Wide	LN	E	52	H	61-65W x 25D x 38H	2	1.4	3.3	3,164	3,394	3,523	3,650	3,779	3,908	4,049	4,187	4,353	4,552	4,785	5,031	5,269	5,499	
	66-70in Wide	LN	E	52	H	66-70W x 25D x 38H	2.1	1.6	3.7	3,275	3,528	3,670	3,809	3,951	4,093	4,249	4,400	4,583	4,802	5,059	5,329	5,591	5,844	
	71-75in Wide	LN	E	52	H	71-75W x 25D x 38H	2.2	1.9	4.1	3,386	3,669	3,829	3,985	4,144	4,304	4,478	4,647	4,853	5,098	5,386	5,689	5,982	6,266	

To Order Select Below

<p><b>1. Series/Type/Unit</b></p> <p>●</p> <hr/> <p>LNE52</p> <hr/> <p><b>Luna</b> <b>Elevated</b> <b>Round End Cap</b></p>	<p><b>2. Back Height</b></p> <p>●</p> <hr/> <p>H HIGH BACK</p> <hr/> <p>L LOW BACK</p>	<p><b>3. Width</b></p> <p>●</p> <hr/> <p>XX WIDTH</p> <hr/> <p>Available in 50-75"</p> <p>65" is for wrapping around planters.</p>	<p><b>4. Upholstery Options</b></p> <p>●</p> <hr/> <p>DF DUAL UPHOLSTERY</p>	<p><b>5. Postion</b></p> <p>●</p> <hr/> <p>M MID</p> <hr/> <p>NL NO LEGS</p>	<p><b>6. Leg Finish</b></p> <p>●</p> <hr/> <p><b>Standard Powder Coated Metal</b></p> <table border="0"> <tr><td>BL</td><td>BLUE</td><td>NK</td><td>NICKEL</td></tr> <tr><td>BM</td><td>BLACK MATTE</td><td>NV</td><td>NAVY</td></tr> <tr><td>BR</td><td>BRASS</td><td>OR</td><td>ORANGE</td></tr> <tr><td>BT</td><td>BLACK TWILIGHT</td><td>PY</td><td>PALE YELLOW</td></tr> <tr><td>CP</td><td>CHAMPAGNE</td><td>RD</td><td>RED</td></tr> <tr><td>DB</td><td>DARK BRONZE</td><td>RO</td><td>RED ORANGE</td></tr> <tr><td>DG</td><td>DARK GRAY</td><td>RR</td><td>RUSTY RED</td></tr> <tr><td>DP</td><td>DUSTY PINK</td><td>SB</td><td>SOFT BLUE</td></tr> <tr><td>FG</td><td>FOREST GREEN</td><td>SD</td><td>SAND</td></tr> <tr><td>LG</td><td>LIGHT GRAY</td><td>TC</td><td>TERRACOTTA</td></tr> <tr><td>MG</td><td>MEADOW GREEN</td><td>TP</td><td>TAUPE</td></tr> <tr><td>MK</td><td>MILK</td><td>TS</td><td>TEXTURED SLATE</td></tr> <tr><td>MS</td><td>METALLIC SILVER</td><td>YL</td><td>YELLOW</td></tr> </table> <hr/> <p>●</p> <hr/> <p><b>Polished Metal</b></p> <hr/> <p>AL POLISHED ALUMINUM</p>	BL	BLUE	NK	NICKEL	BM	BLACK MATTE	NV	NAVY	BR	BRASS	OR	ORANGE	BT	BLACK TWILIGHT	PY	PALE YELLOW	CP	CHAMPAGNE	RD	RED	DB	DARK BRONZE	RO	RED ORANGE	DG	DARK GRAY	RR	RUSTY RED	DP	DUSTY PINK	SB	SOFT BLUE	FG	FOREST GREEN	SD	SAND	LG	LIGHT GRAY	TC	TERRACOTTA	MG	MEADOW GREEN	TP	TAUPE	MK	MILK	TS	TEXTURED SLATE	MS	METALLIC SILVER	YL	YELLOW	<p><b>7. Options</b></p> <p>●</p> <hr/> <p>T TRAY/TABLET ARM ATTACHED TO UNIT</p> <hr/> <p>Accessory attaches to right side of seat unit. Trays and tablet arm seat mount units can only be used between units</p>	<p><b>8. Upholstery</b></p> <p>●</p> <hr/> <p>See <a href="#">general information section</a> for details on textile program and COM information</p>
BL	BLUE	NK	NICKEL																																																								
BM	BLACK MATTE	NV	NAVY																																																								
BR	BRASS	OR	ORANGE																																																								
BT	BLACK TWILIGHT	PY	PALE YELLOW																																																								
CP	CHAMPAGNE	RD	RED																																																								
DB	DARK BRONZE	RO	RED ORANGE																																																								
DG	DARK GRAY	RR	RUSTY RED																																																								
DP	DUSTY PINK	SB	SOFT BLUE																																																								
FG	FOREST GREEN	SD	SAND																																																								
LG	LIGHT GRAY	TC	TERRACOTTA																																																								
MG	MEADOW GREEN	TP	TAUPE																																																								
MK	MILK	TS	TEXTURED SLATE																																																								
MS	METALLIC SILVER	YL	YELLOW																																																								

# Luna

PLINTH: STANDARD

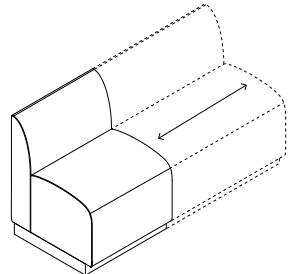
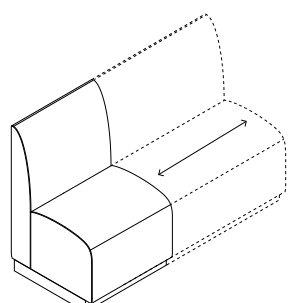
	WIDTHS	SERIES	TYPE	UNIT	BACK HEIGHT	DIMENSIONS	Yardage Requirements			Textile Upholstery Grades														
							SEAT	BACK	BACK/SEAT	COM	A	B	C	D	E	F	G	H	I	J	K	L	M	
 <p><b>Plinth, Standard, Low Back</b></p>	25-30in Wide	LN	P	11	L	25-30W x 25D x 31H	1.7	1.5	3	2,516	2,723	2,839	2,953	3,069	3,186	3,313	3,436	3,586	3,765	3,975	4,197	4,411	4,618	
	31-35in Wide	LN	P	11	L	31-35W x 25D x 31H	1.8	1.6	3.3	2,699	2,929	3,058	3,185	3,314	3,443	3,584	3,722	3,888	4,087	4,320	4,566	4,804	5,034	
	36-40in Wide	LN	P	11	L	36-40W x 25D x 31H	1.9	1.8	3.7	2,882	3,135	3,277	3,416	3,558	3,700	3,856	4,007	4,190	4,409	4,666	4,936	5,198	5,451	
	41-45in Wide	LN	P	11	L	41-45W x 25D x 31H	2.1	1.9	4	3,065	3,341	3,496	3,648	3,803	3,958	4,127	4,292	4,492	4,731	5,011	5,306	5,591	5,867	
	46-50in Wide	LN	P	11	L	46-50W x 25D x 31H	2.2	2.1	4.2	3,248	3,539	3,702	3,863	4,026	4,190	4,369	4,543	4,754	5,006	5,302	5,613	5,915	6,206	
	51-55in Wide	LN	P	11	L	51-55W x 25D x 31H	2.5	2.2	4.6	3,431	3,745	3,921	4,095	4,271	4,448	4,641	4,828	5,056	5,328	5,647	5,983	6,308	6,622	
	56-60in Wide	LN	P	11	L	56-60W x 25D x 31H	2.6	2.5	4.9	3,614	3,951	4,140	4,326	4,515	4,705	4,912	5,113	5,358	5,650	5,992	6,353	6,701	7,039	
 <p><b>Plinth, Standard, High Back</b></p>	25-30in Wide	LN	P	11	H	25-30W x 25D x 38H	1.7	2.4	3.9	2,660	2,928	3,079	3,227	3,377	3,528	3,693	3,853	4,047	4,279	4,552	4,839	5,116	5,384	
	31-35in Wide	LN	P	11	H	31-35W x 25D x 38H	1.8	2.7	4.3	2,890	3,188	3,356	3,521	3,689	3,857	4,041	4,219	4,436	4,694	4,998	5,318	5,627	5,926	
	36-40in Wide	LN	P	11	H	36-40W x 25D x 38H	1.9	3	4.9	3,120	3,457	3,646	3,832	4,021	4,211	4,418	4,619	4,864	5,156	5,498	5,859	6,207	6,545	
	41-45in Wide	LN	P	11	H	41-45W x 25D x 38H	2.1	3.2	5.3	3,350	3,717	3,924	4,127	4,333	4,540	4,766	4,986	5,252	5,571	5,944	6,338	6,718	7,086	
	46-50in Wide	LN	P	11	H	46-50W x 25D x 38H	2.2	2.9	5.1	3,580	3,932	4,130	4,325	4,522	4,721	4,937	5,148	5,403	5,708	6,066	6,443	6,808	7,161	
	51-55in Wide	LN	P	11	H	51-55W x 25D x 38H	2.5	3.1	5.5	3,810	4,193	4,408	4,619	4,834	5,050	5,285	5,514	5,792	6,123	6,512	6,922	7,318	7,702	
	56-60in Wide	LN	P	11	H	56-60W x 25D x 38H	2.6	3.3	5.9	4,039	4,444	4,673	4,897	5,125	5,353	5,602	5,845	6,140	6,491	6,903	7,338	7,758	8,164	

**To Order Select Below**

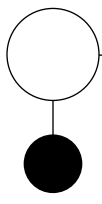
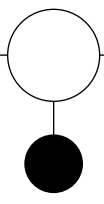
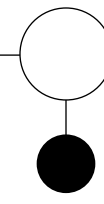
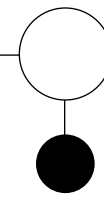
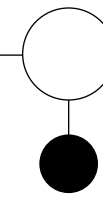
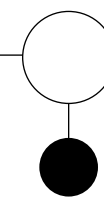
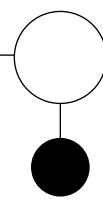
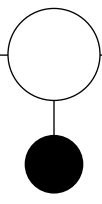
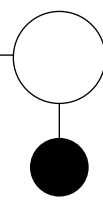
<p><b>1. Series/Type/Unit</b></p>  <hr/> <p>LNP11</p> <p><b>Luna Plinth Standard</b></p>	<p><b>2. Back Height</b></p>  <hr/> <p>H HIGH BACK</p> <p>L LOW BACK</p>	<p><b>3. Length</b></p>  <hr/> <p>XX LENGTH</p> <p>Available in 25-60"</p>	<p><b>4. Upholstery Options</b></p>  <hr/> <p>DF DUAL UPHOLSTERY</p>	<p><b>5. Position</b></p>  <hr/> <p>F FREESTANDING</p> <p>S START</p> <p>M MID</p> <p>E END</p>	<p><b>6. Layout Options</b></p>  <hr/> <p>B BACK-TO-BACK</p> <p>Back-to-back not available on mid units.</p>	<p><b>7. Plinth Finish</b></p>  <hr/> <p>LM05 DOVE GRAY</p> <p>LM09 BLACK</p> <p>LM14 WALNUT HEIGHTS</p> <p>LM18 CASTLE OAK</p>	<p><b>8. Options</b></p>  <hr/> <p><b>Power Options</b></p> <p><b>See flush mount power ordering options and rules.</b></p> <hr/> <p><b>Accessory Attachment</b></p> <p>T TRAY/TABLET ARM ATTACHED TO UNIT</p> <p>Accessory attaches to right side of seat unit. Trays and tablet arm seat mount units can only be used between units. Not available on Arm Right Units</p>	<p><b>9. Upholstery</b></p>  <hr/> <p><b>See general information section for details on textile program and COM information</b></p>
--	---	---	--	--	---	--	--	--

# Luna

PLINTH: ARM LEFT OR RIGHT

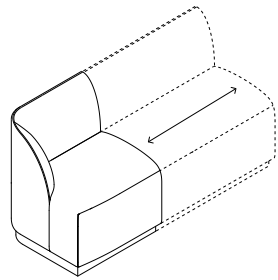
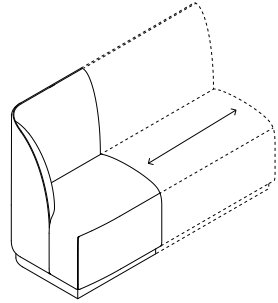
	WIDTHS	SERIES	TYPE	UNIT	BACK HEIGHT	DIMENSIONS	Yardage Requirements			Textile Upholstery Grades														
							SEAT	BACK	BACK/SEAT	COM	A	B	C	D	E	F	G	H	I	J	K	L	M	
 <p><b>Plinth, Arm Left/Right, Low Back</b></p>	25-30in Wide	LN	P	21/22	L	25-30W x 25D x 31H	1.5	1.6	3	3,090	3,297	3,413	3,527	3,643	3,760	3,887	4,010	4,160	4,339	4,549	4,771	4,985	5,192	
	31-35in Wide	LN	P	21/22	L	31-35W x 25D x 31H	1.7	1.8	3.3	3,276	3,506	3,635	3,762	3,891	4,020	4,161	4,299	4,465	4,664	4,897	5,143	5,381	5,611	
	36-40in Wide	LN	P	21/22	L	36-40W x 25D x 31H	1.8	1.9	3.7	3,461	3,714	3,856	3,995	4,137	4,279	4,435	4,586	4,769	4,988	5,245	5,515	5,777	6,030	
	41-45in Wide	LN	P	21/22	L	41-45W x 25D x 31H	1.9	2.1	4	3,646	3,922	4,077	4,229	4,384	4,539	4,708	4,873	5,073	5,312	5,592	5,887	6,172	6,448	
	46-50in Wide	LN	P	21/22	L	46-50W x 25D x 31H	2	2.2	4.1	3,831	4,114	4,274	4,430	4,589	4,749	4,923	5,092	5,298	5,543	5,831	6,134	6,427	6,711	
	51-55in Wide	LN	P	21/22	L	51-55W x 25D x 31H	2.1	2.4	4.4	4,016	4,322	4,494	4,664	4,835	5,008	5,196	5,379	5,601	5,867	6,178	6,506	6,823	7,130	
	56-60in Wide	LN	P	21/22	L	56-60W x 25D x 31H	2.2	2.5	4.7	4,201	4,522	4,703	4,881	5,061	5,242	5,440	5,632	5,866	6,144	6,471	6,815	7,148	7,470	
 <p><b>Plinth, Arm Left/Right, High Back</b></p>	25-30in Wide	LN	P	21/22	H	25-30W x 25D x 38H	1.5	2.4	3.7	3,324	3,577	3,719	3,858	4,000	4,142	4,298	4,449	4,632	4,851	5,108	5,378	5,640	5,893	
	31-35in Wide	LN	P	21/22	H	31-35W x 25D x 38H	1.7	2.6	4.1	3,555	3,838	3,998	4,154	4,313	4,473	4,647	4,816	5,022	5,267	5,555	5,858	6,151	6,435	
	36-40in Wide	LN	P	21/22	H	36-40W x 25D x 38H	1.8	2.9	4.6	3,786	4,100	4,276	4,450	4,626	4,803	4,996	5,183	5,411	5,683	6,002	6,338	6,663	6,977	
	41-45in Wide	LN	P	21/22	H	41-45W x 25D x 38H	1.9	3.2	5.1	4,017	4,369	4,567	4,762	4,959	5,158	5,374	5,585	5,840	6,145	6,503	6,880	7,245	7,598	
	46-50in Wide	LN	P	21/22	H	46-50W x 25D x 38H	2	3.2	5.2	4,248	4,608	4,810	5,009	5,211	5,413	5,634	5,850	6,111	6,422	6,788	7,173	7,546	7,906	
	51-55in Wide	LN	P	21/22	H	51-55W x 25D x 38H	2.1	3.6	5.5	4,479	4,862	5,077	5,288	5,503	5,719	5,954	6,183	6,461	6,792	7,181	7,591	7,987	8,371	
	56-60in Wide	LN	P	21/22	H	56-60W x 25D x 38H	2.2	3.8	6	4,710	5,123	5,356	5,584	5,816	6,049	6,303	6,550	6,850	7,208	7,628	8,071	8,499	8,913	

**To Order Select Below**

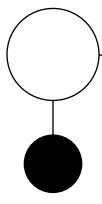
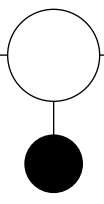
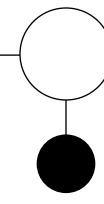
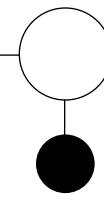
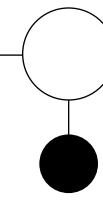
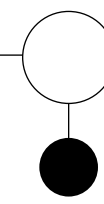
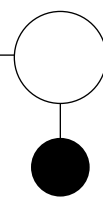
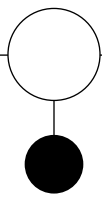
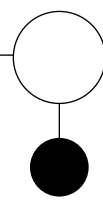
<p><b>1. Series/Type/Unit</b></p>  <p>LUNA PLINTH ARM LEFT LNP21</p> <p>LUNA PLINTH ARM RIGHT LNP22</p> <p>Plinth Arm Right shown above</p>	<p><b>2. Back Height</b></p>  <p>Back Height</p> <p>H HIGH BACK</p> <p>L LOW BACK</p>	<p><b>3. Length</b></p>  <p>Length</p> <p>XX LENGTH</p> <p>Available in 25-60"</p>	<p><b>4. Upholstery Options</b></p>  <p>Upholstery Options</p> <p>DF DUAL UPHOLSTERY</p>	<p><b>5. Position</b></p>  <p>Position</p> <p>F FREESTANDING</p> <p>S START</p> <p>E END</p>	<p><b>6. Layout Options</b></p>  <p>Layout Options</p> <p>B BACK-TO-BACK</p> <p>Back-to-back not available on mid units.</p>	<p><b>7. Plinth Finish</b></p>  <p>Plinth Finish</p> <p>LM05 DOVE GRAY</p> <p>LM09 BLACK</p> <p>LM14 WALNUT HEIGHTS</p> <p>LM18 CASTLE OAK</p>	<p><b>8. Options</b></p>  <p>Power Options</p> <p>See flush mount power ordering options and rules.</p> <p><b>Accessory Attachment</b></p> <p>T TRAY/TABLET ARM ATTACHED TO UNIT</p> <p>Accessory attaches to right side of seat unit. Trays and tablet arm seat mount units can only be used between units. Not available on Arm Right Units</p>	<p><b>9. Upholstery</b></p>  <p>See general information section for details on textile program and COM information</p>
---	--	---	--	---	---	---	--	---

# Luna

PLINTH: ARM BOTH

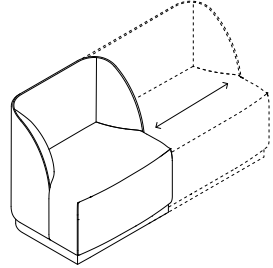
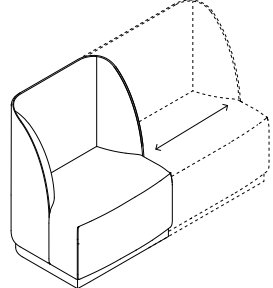
	WIDTHS	SERIES	TYPE	UNIT	BACK HEIGHT	DIMENSIONS	Yardage Requirements			Textile Upholstery Grades														
							SEAT	BACK	BACK/SEAT	COM	A	B	C	D	E	F	G	H	I	J	K	L	M	
 <p><b>Plinth, Arm Both, Low Back</b></p>	30-35in Wide	LN	P	23	L	30-35W x 25D x 31H	1.4	2	3.2	3,957	4,179	4,304	4,427	4,551	4,676	4,813	4,945	5,107	5,299	5,524	5,762	5,992	6,215	
	36-40in Wide	LN	P	23	L	36-40W x 25D x 31H	1.5	2.1	3.5	4,147	4,384	4,518	4,649	4,782	4,916	5,062	5,204	5,376	5,581	5,823	6,077	6,322	6,560	
	41-45in Wide	LN	P	23	L	41-45W x 25D x 31H	1.6	2.4	3.8	4,336	4,596	4,743	4,887	5,033	5,179	5,339	5,495	5,684	5,909	6,174	6,452	6,722	6,983	
	46-50in Wide	LN	P	23	L	46-50W x 25D x 31H	1.7	2.5	4.1	4,526	4,809	4,969	5,125	5,284	5,444	5,618	5,787	5,993	6,238	6,526	6,829	7,122	7,406	
	51-55in Wide	LN	P	23	L	51-55W x 25D x 31H	1.8	2.6	4.3	4,716	5,014	5,182	5,347	5,515	5,683	5,867	6,045	6,262	6,520	6,824	7,144	7,453	7,752	
	56-60in Wide	LN	P	23	L	56-60W x 25D x 31H	2	2.8	4.7	4,905	5,226	5,407	5,585	5,765	5,946	6,144	6,336	6,570	6,848	7,175	7,519	7,852	8,174	
 <p><b>Plinth, Arm Both, High Back</b></p>	30-35in Wide	LN	P	23	H	30-35W x 25D x 38H	1.4	2.8	4	4,284	4,560	4,715	4,867	5,022	5,177	5,346	5,511	5,711	5,950	6,230	6,525	6,810	7,086	
	36-40in Wide	LN	P	23	H	36-40W x 25D x 38H	1.5	3	4.3	4,484	4,782	4,950	5,115	5,283	5,451	5,635	5,813	6,030	6,288	6,592	6,912	7,221	7,520	
	41-45in Wide	LN	P	23	H	41-45W x 25D x 38H	1.6	3.2	4.7	4,684	5,005	5,186	5,364	5,544	5,725	5,923	6,115	6,349	6,627	6,954	7,298	7,631	7,953	
	46-50in Wide	LN	P	23	H	46-50W x 25D x 38H	1.7	3.6	5.1	4,884	5,236	5,434	5,629	5,826	6,025	6,241	6,452	6,707	7,012	7,370	7,747	8,112	8,465	
	51-55in Wide	LN	P	23	H	51-55W x 25D x 38H	1.8	3.8	5.5	5,084	5,467	5,682	5,893	6,108	6,324	6,559	6,788	7,066	7,397	7,786	8,196	8,592	8,976	
	56-60in Wide	LN	P	23	H	56-60W x 25D x 38H	2	4	5.9	5,284	5,689	5,918	6,142	6,370	6,598	6,847	7,090	7,385	7,736	8,148	8,583	9,003	9,409	

**To Order Select Below**

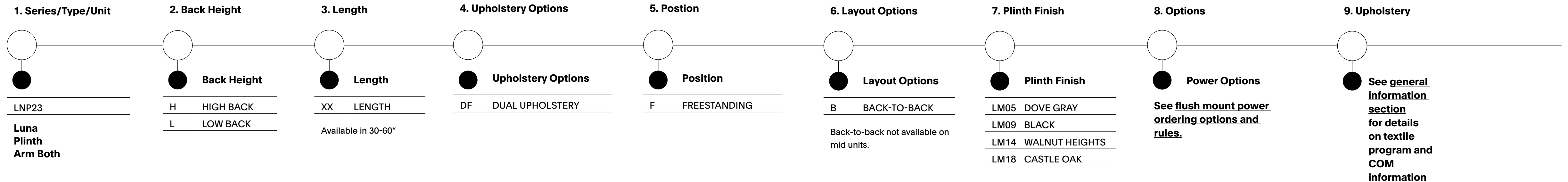

# Luna

PLINTH: ARMLESS LEFT OR RIGHT

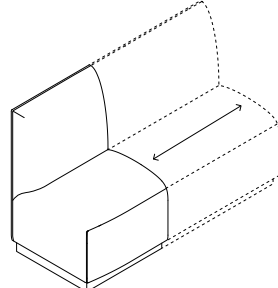
	WIDTHS	SERIES	TYPE	UNIT	BACK HEIGHT	DIMENSIONS	Yardage Requirements			Textile Upholstery Grades														
							SEAT	BACK	BACK/SEAT	COM	A	B	C	D	E	F	G	H	I	J	K	L	M	
 <p><b>Plinth, Armless End Left/Right, Low Back</b></p>	25-30in Wide	LN	P	31/32	L	25-30W x 25D x 31H	1.6	1.3	2.8	2,626	2,818	2,925	3,031	3,138	3,246	3,364	3,478	3,617	3,783	3,977	4,182	4,380	4,572	
	31-35in Wide	LN	P	31/32	L	31-35W x 25D x 31H	1.8	1.5	3.1	2,844	3,058	3,179	3,297	3,418	3,538	3,670	3,798	3,954	4,140	4,357	4,587	4,809	5,024	
	36-40in Wide	LN	P	31/32	L	36-40W x 25D x 31H	1.9	1.6	3.5	3,061	3,298	3,432	3,563	3,696	3,830	3,976	4,118	4,290	4,495	4,737	4,991	5,236	5,474	
	41-45in Wide	LN	P	31/32	L	41-45W x 25D x 31H	2.1	1.7	3.8	3,278	3,538	3,685	3,829	3,975	4,121	4,281	4,437	4,626	4,851	5,116	5,394	5,664	5,925	
	46-50in Wide	LN	P	31/32	L	46-50W x 25D x 31H	2.2	1.9	4	3,495	3,771	3,926	4,078	4,233	4,388	4,557	4,722	4,922	5,161	5,441	5,736	6,021	6,297	
	51-55in Wide	LN	P	31/32	L	51-55W x 25D x 31H	2.4	2	4.3	3,712	4,010	4,178	4,343	4,511	4,679	4,863	5,041	5,258	5,516	5,820	6,140	6,449	6,748	
	56-60in Wide	LN	P	31/32	L	56-60W x 25D x 31H	2.6	2.2	4.7	3,929	4,250	4,431	4,609	4,789	4,970	5,168	5,360	5,594	5,872	6,199	6,543	6,876	7,198	
 <p><b>Plinth, Armless End Left/Right, High Back</b></p>	25-30in Wide	LN	P	31/32	H	25-30W x 25D x 38H	1.6	2.4	3.8	2,779	3,039	3,186	3,330	3,476	3,622	3,782	3,938	4,127	4,352	4,617	4,895	5,165	5,426	
	31-35in Wide	LN	P	31/32	H	31-35W x 25D x 38H	1.8	2.6	4.3	3,009	3,307	3,475	3,640	3,808	3,976	4,160	4,338	4,555	4,813	5,117	5,437	5,746	6,045	
	36-40in Wide	LN	P	31/32	H	36-40W x 25D x 38H	1.9	2.9	4.8	3,239	3,568	3,753	3,935	4,120	4,305	4,508	4,704	4,943	5,228	5,563	5,915	6,256	6,586	
	41-45in Wide	LN	P	31/32	H	41-45W x 25D x 38H	2.1	3.2	5.2	3,469	3,829	4,031	4,230	4,432	4,634	4,855	5,071	5,332	5,643	6,009	6,394	6,767	7,127	
	46-50in Wide	LN	P	31/32	H	46-50W x 25D x 38H	2.2	2.8	5	3,699	4,043	4,237	4,428	4,621	4,815	5,027	5,233	5,483	5,781	6,131	6,500	6,857	7,202	
	51-55in Wide	LN	P	31/32	H	51-55W x 25D x 38H	2.4	3	5.3	3,929	4,296	4,503	4,706	4,912	5,119	5,345	5,565	5,831	6,150	6,523	6,917	7,297	7,665	
	56-60in Wide	LN	P	31/32	H	56-60W x 25D x 38H	2.6	3.2	5.8	4,159	4,557	4,781	5,001	5,224	5,448	5,693	5,931	6,220	6,565	6,969	7,396	7,808	8,207	

**To Order Select Below**

<p><b>1. Series/Type/Unit</b></p> <p>LUNA PLINTH ARMLESS LEFT LNP31</p> <p>LUNA PLINTH ARMLESS RIGHT LNEP2</p>	<p><b>2. Back Height</b></p> <p>H HIGH BACK</p> <p>L LOW BACK</p>	<p><b>3. Width</b></p> <p>XX WIDTH</p> <p>Available in 25-60"</p>	<p><b>4. Upholstery Options</b></p> <p>DF DUAL UPHOLSTERY</p>	<p><b>5. Postion</b></p> <p>F FREESTANDING</p> <p>S START</p> <p>E END</p>	<p><b>6. Layout Options</b></p> <p>B BACK-TO-BACK</p> <p>Back-to-back not available on mid units.</p>	<p><b>7. Plinth Finish</b></p> <p>LM05 DOVE GRAY</p> <p>LM09 BLACK</p> <p>LM14 WALNUT HEIGHTS</p> <p>LM18 CASTLE OAK</p>	<p><b>8. Options</b></p> <p>Power Options</p> <p>See flush mount power ordering options and rules.</p> <p>Accessory Attachment</p> <p>T TRAY/TABLET ARM ATTACHED TO UNIT</p>	<p><b>9. Upholstery</b></p> <p>See general information section for details on textile program and COM information</p>
--	---	---	---	--	---	--	--	---

Plinth Armless Right shown above

Accessory attaches to right side of seat unit. Trays and tablet arm seat mount units can only be used between units. Not available on Armless Right Units

# Luna

PLINTH: ROUND INSIDE CORNER

	WIDTH	SERIES	TYPE	UNIT	BACK HEIGHT	DIMENSIONS	Yardage Requirements			Textile Upholstery Grades													
							SEAT	BACK	BACK/SEAT	COM	A	B	C	D	E	F	G	H	I	J	K	L	M
 <p><b>Plinth, Round Inside Corner, Low Back</b></p>	25	LN	P	41	L	25W x 25D x 31H	1.3	2	3.2	2,695	2,917	3,042	3,165	3,289	3,414	3,551	3,683	3,845	4,037	4,262	4,500	4,730	4,953
 <p><b>Plinth, Round Inside Corner, High Back</b></p>	25	LN	P	41	H	25W x 25D x 38H	1.3	2.8	4	3,084	3,360	3,515	3,667	3,822	3,977	4,146	4,311	4,511	4,750	5,030	5,325	5,610	5,886

**To Order Select Below**

**1. Series/Type/Unit**

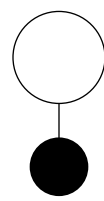

LNP41

**Luna  
Plinth  
Round Inside Corner**

**2. Back Height**

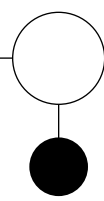

**Back Height**

H HIGH BACK

L LOW BACK

**3. Width**

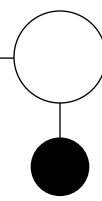

**Width**

25 WIDTH

**4. Upholstery Options**

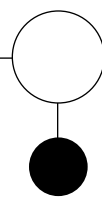

**Upholstery Options**

DF DUAL UPHOLSTERY

**5. Postion**

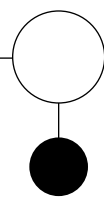

**Position**

M MID

**6. Plinth Finish**

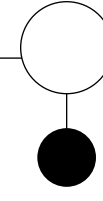

**Plinth Finish**

LM05 DOVE GRAY

LM09 BLACK

LM14 WALNUT HEIGHTS

LM18 CASTLE OAK

**7. Upholstery**

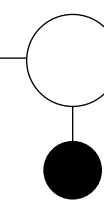

**See general information section for details on textile program and COM information**

# Luna

PLINTH: SQUARE INSIDE CORNER

	WIDTH	SERIES	TYPE	UNIT	BACK HEIGHT	DIMENSIONS	Yardage Requirements			Textile Upholstery Grades													
							SEAT	BACK	BACK/SEAT	COM	A	B	C	D	E	F	G	H	I	J	K	L	M
 <p><b>Plinth, Square Inside Corner, Low Back</b></p>	25	LN	P	42	L	25W x 25D x 31H	1.3	2.1	3.2	2,763	2,985	3,110	3,233	3,357	3,482	3,619	3,751	3,913	4,105	4,330	4,568	4,798	5,021
 <p><b>Plinth, Square Inside Corner, High Back</b></p>	25	LN	P	42	H	25W x 25D x 38H	1.3	2.8	4	2,936	3,212	3,367	3,519	3,674	3,829	3,998	4,163	4,363	4,602	4,882	5,177	5,462	5,738

**To Order Select Below**

**1. Series/Type/Unit**

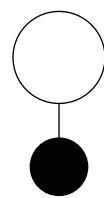

LNP42

**Luna  
Plinth  
Square Inside Corner**

**2. Back Height**

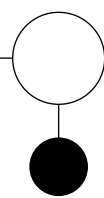

**Back Height**  
H HIGH BACK  
L LOW BACK

**3. Width**

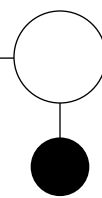

**Width**  
25 WIDTH

**4. Upholstery Options**

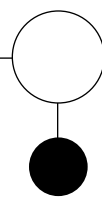

**Upholstery Options**  
DF DUAL UPHOLSTERY

**5. Postion**

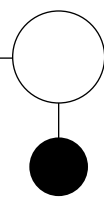

**Position**  
M MID

**6. Plinth Finish**

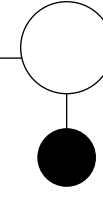

**Plinth Finish**  
LM05 DOVE GRAY  
LM09 BLACK  
LM14 WALNUT HEIGHTS  
LM18 CASTLE OAK

**7. Upholstery**

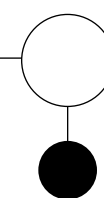

**See general information section for details on textile program and COM information**



# Luna

## PLINTH: ROUND OUTSIDE CORNER

	WIDTH	SERIES	TYPE	UNIT	BACK HEIGHT	DIMENSIONS	Yardage Requirements			Textile Upholstery Grades													
							SEAT	BACK	BACK/SEAT	COM	A	B	C	D	E	F	G	H	I	J	K	L	M
 <p><b>Plinth, Round Outside Corner, Low Back</b></p>	25	LN	P	51	L	25W x 25D x 31H	1.9	0.5	2.4	1,977	2,138	2,228	2,317	2,407	2,498	2,597	2,693	2,810	2,949	3,112	3,284	3,451	3,612
 <p><b>Plinth, Round Outside Corner, High Back</b></p>	25	LN	P	51	H	25W x 25D x 38H	1.9	0.8	2.6	2,111	2,287	2,386	2,484	2,582	2,682	2,790	2,895	3,023	3,175	3,354	3,543	3,725	3,902

### To Order Select Below

#### 1. Series/Type/Unit

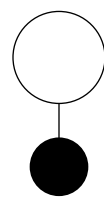

LNP51

**Luna  
Plinth  
Round Outside Corner**

#### 2. Back Height

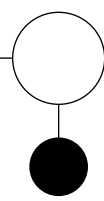

**Back Height**  
H HIGH BACK  
L LOW BACK

#### 3. Width

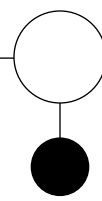

**Width**  
25 WIDTH

#### 4. Upholstery Options

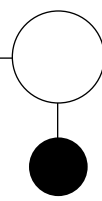

**Upholstery Options**  
DF DUAL UPHOLSTERY

#### 5. Position

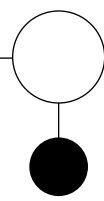

**Position**  
M MID

#### 6. Options

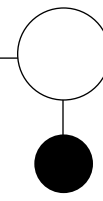

**Accessory Attachment**  
TRAY/TABLET ARM  
ATTACHED TO UNIT

Accessory attaches to right side of seat unit. Trays and tablet arm seat mount units can only be used between units

#### 7. Plinth Finish

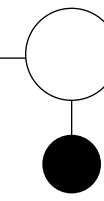

**Plinth Finish**  
LM05 DOVE GRAY  
LM09 BLACK  
LM14 WALNUT HEIGHTS  
LM18 CASTLE OAK

#### 8. Upholstery

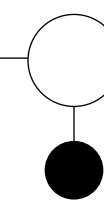

**See general information section for details on textile program and COM information**

# Luna

## PLINTH: ROUND END CAP

	WIDTHS	SERIES	TYPE	UNIT	BACK HEIGHT	DIMENSIONS	Yardage Requirements			Textile Upholstery Grades														
							SEAT	BACK	BACK/SEAT	COM	A	B	C	D	E	F	G	H	I	J	K	L	M	
	50-55in Wide	LN	P	52	L	50-55W x 25D x 31H	2.8	0.8	3.6	3,356	3,601	3,739	3,874	4,012	4,150	4,300	4,447	4,624	4,837	5,086	5,348	5,602	5,847	
	56-60in Wide	LN	P	52	L	56-60W x 25D x 31H	3	1	3.9	3,540	3,808	3,959	4,107	4,257	4,408	4,573	4,733	4,927	5,159	5,432	5,719	5,996	6,264	
	61-65in Wide	LN	P	52	L	61-65W x 25D x 31H	3	1.1	4.1	3,724	4,007	4,167	4,323	4,482	4,642	4,816	4,985	5,191	5,436	5,724	6,027	6,320	6,604	
	66-70in Wide	LN	P	52	L	66-70W x 25D x 31H	3	1.4	4.2	3,908	4,199	4,362	4,523	4,686	4,850	5,029	5,203	5,414	5,666	5,962	6,273	6,575	6,866	
	71-75in Wide	LN	P	52	L	71-75W x 25D x 31H	3	1.5	4.4	4,092	4,398	4,570	4,740	4,911	5,084	5,272	5,455	5,677	5,943	6,254	6,582	6,899	7,206	
	50-55in Wide	LN	P	52	H	50-55W x 25D x 38H	2.8	1.1	3.9	3,487	3,755	3,906	4,054	4,204	4,355	4,520	4,680	4,874	5,106	5,379	5,666	5,943	6,211	
	56-60in Wide	LN	P	52	H	56-60W x 25D x 38H	3	1.4	4.2	3,674	3,965	4,128	4,289	4,452	4,616	4,795	4,969	5,180	5,432	5,728	6,039	6,341	6,632	
	61-65in Wide	LN	P	52	H	61-65W x 25D x 38H	3	1.6	4.6	3,860	4,174	4,350	4,524	4,700	4,877	5,070	5,257	5,485	5,757	6,076	6,412	6,737	7,051	
	66-70in Wide	LN	P	52	H	66-70W x 25D x 38H	3	1.8	4.8	4,047	4,376	4,561	4,743	4,928	5,113	5,316	5,512	5,751	6,036	6,371	6,723	7,064	7,394	
	71-75in Wide	LN	P	52	H	71-75W x 25D x 38H	3.1	2.1	5.1	4,233	4,585	4,783	4,978	5,175	5,374	5,590	5,801	6,056	6,361	6,719	7,096	7,461	7,814	

### To Order Select Below

<p><b>1. Series/Type/Unit</b></p> <p>LNP52</p> <p><b>Luna Plinth Round End Cap</b></p>	<p><b>2. Back Height</b></p> <p>H HIGH BACK</p> <p>L LOW BACK</p>	<p><b>3. Width</b></p> <p>XX WIDTH</p> <p>Available in 50-75"</p>	<p><b>4. Upholstery Options</b></p> <p>DF DUAL UPHOLSTERY</p>	<p><b>5. Postion</b></p> <p>M MID</p>	<p><b>6. Options</b></p> <p>T TRAY/TABLET ARM ATTACHED TO UNIT</p> <p>Accessory attaches to right side of seat unit. Trays and tablet arm seat mount units can only be used between units</p>	<p><b>7. Plinth Finish</b></p> <p>LM05 DOVE GRAY</p> <p>LM09 BLACK</p> <p>LM14 WALNUT HEIGHTS</p> <p>LM18 CASTLE OAK</p>	<p><b>8. Upholstery</b></p> <p>See <a href="#">general information section</a> for details on textile program and COM information</p>
--	---	---	---	---------------------------------------	---	--	---

# Luna

TRAY TABLE: ROUND OR WIRELESS CHARGING

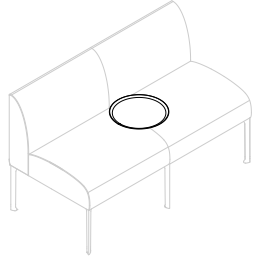
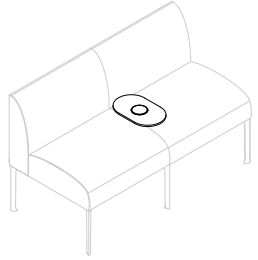
	SERIES	TYPE	DIMENSIONS	PRICE
<b>Tray Table, Round Tray Table</b> 	LN	71	13W x 13D	503
<b>Tray Table, Wireless Charging Tray</b> 	LN	72	8W x 13D	840

**To Order Select Below**

**1. Series/Type**

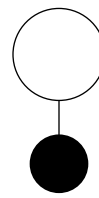

- LN71 ROUND TRAY TABLE
- LN72 WIRELESS CHARGING TRAY

**2. Top Finish**

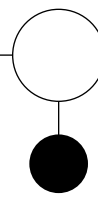

**Wood Finish**

- SW81 WHITE OAK
- SW83 MAPLE
- SW85 WALNUT **+70**
- SW87 OPAQUE BLACK

Only applicable for Wireless Charging Tray

**3. Finish**

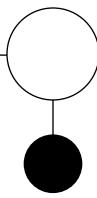

**Standard Powder Coated Metal**

- |                    |                   |
|--------------------|-------------------|
| BL BLUE            | NK NICKEL         |
| BM BLACK MATTE     | NV NAVY           |
| BR BRASS           | OR ORANGE         |
| BT BLACK TWILIGHT  | PY PALE YELLOW    |
| CP CHAMPAGNE       | RD RED            |
| DB DARK BRONZE     | RO RED ORANGE     |
| DG DARK GRAY       | RR RUSTY RED      |
| DP DUSTY PINK      | SB SOFT BLUE      |
| FG FOREST GREEN    | SD SAND           |
| LG LIGHT GRAY      | TC TERRACOTTA     |
| MG MEADOW GREEN    | TP TAUPE          |
| MK MILK            | TS TEXTURED SLATE |
| MS METALLIC SILVER | YL YELLOW         |

Only applicable for Round Tray Table

# Luna

TABLET ARM: UNDER MOUNT

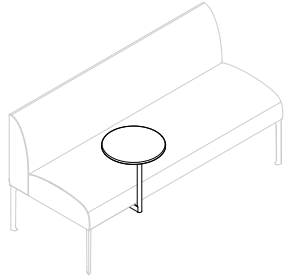
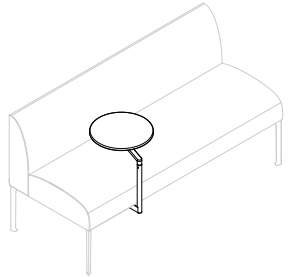
	SERIES	TYPE	DIMENSIONS	PRICE
<b>Tray Table, Tablet Arm, Under Single</b> 	LN	75	14W x 14D	800
<b>Tray Table, Tablet Arm, Under Dual</b> 	LN	76	14W x 14D	800

**To Order Select Below**

**1. Series/Type**

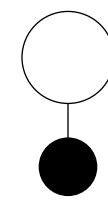

LN75	UNDER MOUNT SINGLE SWIVEL
LN72	UNDER MOUNT DUAL SWIVEL

**2. Top Finish**

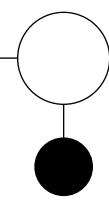

**Wood Finish**

SW81	WHITE OAK
SW83	MAPLE
SW85	WALNUT <b>+70</b>
SW87	OPAQUE BLACK

**3. Finish**

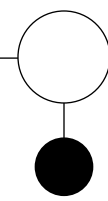

**Standard Powder Coated Metal**

BL	BLUE	NK	NICKEL
BM	BLACK MATTE	NV	NAVY
BR	BRASS	OR	ORANGE
BT	BLACK TWILIGHT	PY	PALE YELLOW
CP	CHAMPAGNE	RD	RED
DB	DARK BRONZE	RO	RED ORANGE
DG	DARK GRAY	RR	RUSTY RED
DP	DUSTY PINK	SB	SOFT BLUE
FG	FOREST GREEN	SD	SAND
LG	LIGHT GRAY	TC	TERRACOTTA
MG	MEADOW GREEN	TP	TAUPE
MK	MILK	TS	TEXTURED SLATE
MS	METALLIC SILVER	YL	YELLOW

# Luna

TABLET ARM: SEAT MOUNT

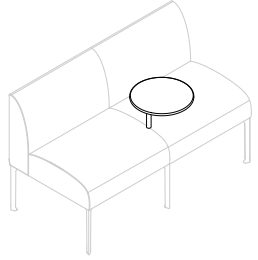
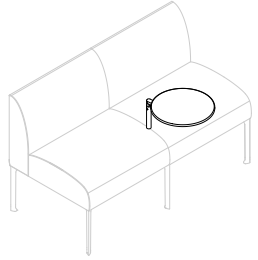
	SERIES	TYPE	DIMENSIONS	PRICE
<b>Tray Table, Tablet Arm, Seat Single</b> 	LN	77	14W x 14D	800
<b>Tray Table, Tablet Arm, Seat Dual</b> 	LN	78	14W x 14D	800

**To Order Select Below**

**1. Series/Type**

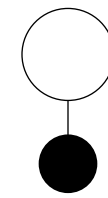

- LN77 SEAT MOUNT SINGLE SWIVEL
- LN78 SEAT MOUNT DUAL SWIVEL

**2. Top Finish**

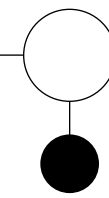

**Wood Finish**

- SW81 WHITE OAK
- SW83 MAPLE
- SW85 WALNUT **+70**
- SW87 OPAQUE BLACK

**3. Finish**

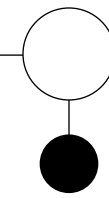

**Standard Powder Coated Metal**

- |                    |                   |
|--------------------|-------------------|
| BL BLUE            | NK NICKEL         |
| BM BLACK MATTE     | NV NAVY           |
| BR BRASS           | OR ORANGE         |
| BT BLACK TWILIGHT  | PY PALE YELLOW    |
| CP CHAMPAGNE       | RD RED            |
| DB DARK BRONZE     | RO RED ORANGE     |
| DG DARK GRAY       | RR RUSTY RED      |
| DP DUSTY PINK      | SB SOFT BLUE      |
| FG FOREST GREEN    | SD SAND           |
| LG LIGHT GRAY      | TC TERRACOTTA     |
| MG MEADOW GREEN    | TP TAUPE          |
| MK MILK            | TS TEXTURED SLATE |
| MS METALLIC SILVER | YL YELLOW         |

# Luna

PLANTER: ENCLOSED

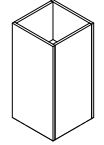
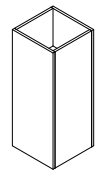
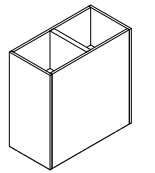
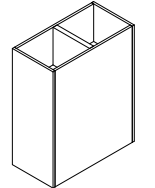
		SERIES	TYPE	HEIGHT	DIMENSIONS	PRICE
Planter, Enclosed, Single, Low Back		LNP	6P1A	LB	15W x 15D x 31H	1,680
Planter, Enclosed, Single, High Back		LNP	6P1A	HB	15W x 15D x 38H	1,919
Planter, Enclosed, Double, Low Back		LNP	6P2A	LB	15W x 30D x 31H	2,426
Planter, Enclosed, Double, High Back		LNP	6P2A	HB	15W x 30D x 38H	2,745

**To Order Select Below**

**1. Series/Type**

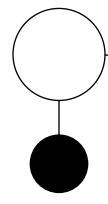

- LUNA PLANTER SINGLE ENCLOSED
- LNP6P1A

---

- LUNA PLANTER DOUBLE ENCLOSED
- LNP6P2A

**2. Planter Height**

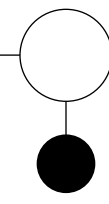

- Planter Height**
- LB LOW BACK
  - HB HIGH BACK

**3. Finish**

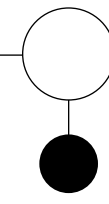

- Finish**
- LM09 BLACK

# Luna

PLANTER: EXPOSED

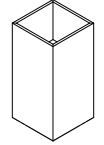
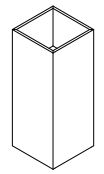
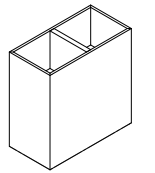
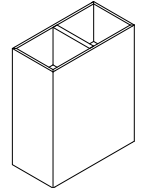
		SERIES	TYPE	HEIGHT	DIMENSIONS	LAMINATE	WOOD VENEER
Planter, Exposed, Single, Low Back		LNP	6P1B	LB	15W x 15D x 31H	2039	4,028
Planter, Exposed, Single, High Back		LNP	6P1B	HB	15W x 15D x 38H	2285	4,407
Planter, Exposed, Double, Low Back		LNP	6P2B	LB	15W x 30D x 31H	3278	5,027
Planter, Exposed, Double, High Back		LNP	6P2B	HB	15W x 30D x 38H	3597	<b>5,393</b>

**To Order Select Below**

**1. Series/Type**

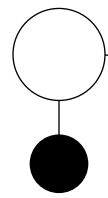

- LUNA PLANTER SINGLE
- LNP6P1B EXPOSED

---

- LUNA PLANTER DOUBLE
- LNP6P2B EXPOSED

**2. Planter Height**

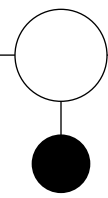

- Planter Height**
- LB LOW BACK
  - HB HIGH BACK

**3. Finish**

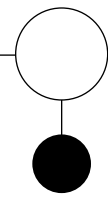

- Finish**
- LM05 DOVE GRAY
  - LM09 BLACK
  - LM14 WALNUT HEIGHTS
  - LM18 CASTLE OAK
  - WV46 NATURAL FLAT CUT WALNUT
  - WV48 NATURAL WHITE OAK