

stylex

F4

PRICE LIST

Effective November 01, 2024

General Information

STYLEX PRICE LIST

GENERAL INFORMATION

Terms

Net 30 days from date of invoice,
F. O. B . Delanco, New Jersey.

Damaged Shipments

All Stylex products are carefully inspected before they are packed in sturdy cartons designed to satisfy shipping requirements. Stylex is not responsible for damage in shipment. The transportation company assumes responsibility for delivering products to you in good condition when the bill of lading is signed. You protect yourself by refusing shipments showing damage or shortage until transportation company has noted on the delivery sheet the extent of damage or shortage. Concealed damage should be reported to the carrier as soon as discovered, but no later than 5 days after receiving shipment.

Return/Restocking Policy

Return shipments will not be accepted unless specifically authorized by Stylex in writing. The Return Authorization number should be clearly marked on the carton. The customer returning Stylex products is responsible for return shipping costs. Merchandise must be returned unused. Returned merchandise is subject to a 35% restocking fee.

Special Products

Modifications to standard products will be considered for large runs. Contact factory for price quotations.

Design Changes

In keeping with modern manufacturing advances, Stylex reserves the right to incorporate minor modifications and design changes in products without notice.

Cancellation/Change Order Policy

Regarding requests for order cancellation and/or order modification, please be advised that no charges will be applied before production, unless inventory has been specifically requisitioned to fulfill your order. Once orders proceed to the production phase, they cannot be altered or canceled under any circumstances. All requests for order cancellations or order changes must be submitted in writing and will only be considered valid upon approval by Stylex.

WARRANTY

Except as provided below, Stylex warrants exclusively to the original Purchaser of our product that all parts, under normal use and service, will be free from defects in workmanship and material for a period of ten (10) years from the date of purchase. "Normal use and service" means that the product will be used in a typical office environment for 40-45 hours per week.

This warranty is subject to the following limitations, exclusions and provisions:

Limitations involving materials and components:

Wood components of plywood stacking chairs
(such as Brooks and Welcome)
5 years

Upholstery

(including mesh used for Click, F4, Insight, and Zephyr Mesh)
3 years

SAVA Mesh

10 years

Pneumatic Cylinders

3 years

COM Upholstery

No warranty
Stylex makes every effort to ensure that the COM Upholstery it approves is suitable for the intended use. Nevertheless, we will not warrant, and assume no responsibility for, the durability or tailoring quality of any COM or COL . If you have any concerns about the ultimate appearance of any covering, please order an upholstered sample.

Painted Stack Chair Frames

No Warranty
We will not warrant the finish of painted stack chair frames against damage from stacking. Please order chrome frames for chairs that will be stacked.

Felt Glides

No warranty
Due to the different surfaces on which felt glides may be used, we cannot warrant their durability over time.

If this product fails during normal use and service within the applicable warranty period (other than through normal wear and tear), please submit a warranty claim at stylexdesign.com/warranty-claim/. Quantity, model details, description of issue, and Stylex certified labels are required for submission. PLEASE DO NOT RETURN PARTS OR THE PRODUCT TO STYLEX UNLESS INSTRUCTED TO DO SO BY STYLEX. Stylex will, at its discretion, either repair or replace the defective product or part at no cost. Labor requests must receive approval and will be authorized on a case-by-case basis. We will only reimburse for labor costs directly incurred, excluding any travel-related expenses. Purchaser may be required (at the option of Stylex) to return to Stylex at Purchaser's expense any defective part with all freight or shipping charges prepaid. The foregoing warranty shall be void if the product has been altered or repaired (other than by Stylex). The warranty does not cover damage to the product caused by accident, neglect, misuse, abuse, modification to the product by anyone other than Stylex or damage caused by use of the product for a purpose other than that for which it was designed. This warranty extends only to the original Purchaser of the product.

No Other Warranties

This warranty is in lieu of all other warranties, expressed or implied, including, but not limited to, implied warranties of merchantability and fitness for a particular purpose. The rights and remedies provided herein are the exclusive rights and remedies of the original purchaser of the product.

No Liability For Damages

In no event shall Stylex or its suppliers be responsible or liable for any special, indirect, consequential, or incidental damages. In no event shall the liability of Stylex exceed the actual purchase price paid to Stylex for the product.

Out of Warranty Products

For all products no longer covered by our warranty, please refer to our Design for Durability and Upgradability Policy. Contact your Account Manager if you would like to purchase any replaceable components to further extend the life of any Stylex seating product. This warranty applies to all Stylex products purchased on April 13, 2018, and thereafter.

PRODUCT TAKE BACK PROGRAM

In order to be good stewards of our products, Stylex offers a pathway towards a Product Take Back Program as a more viable solution to the end of our products' originally intended life.

Stylex supports the sustainable programs of ANEW and offers their added value to our clients through a comprehensive take-back solution for surplus office furniture and materials of any kind, in any condition. ANEW is a 501(c)(3) non-profit organization that exists to provide companies with smart, cost effective alternatives for their surplus furniture and other items with the priority of matching it to non- profits, public agencies and the underserved, within the local community of the project site. Corporate Social Responsibility is raised while the impact on the environment is lowered by diverting products and materials otherwise destined for landfill.

Stylex is proud to offer ANEW to customers dedicated to strengthening their community network by repurposing their furniture, fixtures and architectural materials to those in need. In 2014, Stylex committed to making this relationship a part of our strategic sales strategy. Visit www.anewfound.org to find out more.

To initiate a Product Take Back strategy through ANEW, contact Stylex Account Management at 800-257-5742.

For other end of life recovery options, please see our Product Disassembly Instructions and End of Life Recovery Options documents available on our website in the resources section of each product in our line.

FREIGHT PROGRAM

Freight charges will be calculated as a percentage of the net product price and added to the invoice at the time of shipment. The continental United States has been divided into three zones. Please use the map below to determine freight charges for the product's destination. Minimum freight charge is \$250. Please let us know if you will be shipping to a residential address or require inside delivery as this requires an additional fee. Also please note we need to be made aware if a liftgate is required prior to delivery. If any requests are made at the time of delivery, applicable charges will apply.

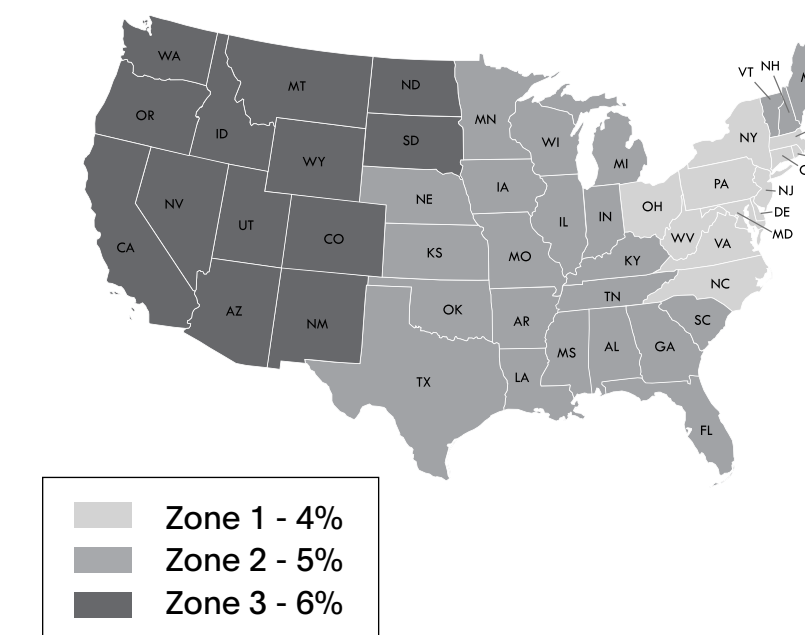

ZONE 1 - 4%

Connecticut
Delaware
New York
New Jersey
Maryland
Massachusetts
North Carolina
Ohio
Pennsylvania
Rhode Island
Virginia
Washington D.C.
West Virginia

ZONE 2 - 5%

Alabama
Arkansas
Canada, Ontario
Canada, Quebec
Florida
Georgia
Iowa
Illinois
Indiana
Kansas
Kentucky
Louisiana
Nebraska
New Hampshire
Oklahoma
Maine
Michigan
Minnesota
Missouri
Mississippi
South Carolina
Tennessee
Texas
Vermont
Wisconsin

ZONE 3 - 6%

Arizona
California
Colorado
Idaho
Montana
Nevada
New Mexico
North Dakota
Oregon
South Dakota
Utah
Washington
Wyoming

Quote Per Project

Alaska
Hawaii
Canada
(outside Ontario & Quebec)
Mexico

General Information

STYLEX PRICE LIST

TEXTILE PARTNERS & APPROVALS

Textile Partners

To customize your furniture performance needs and design vision, Stylex offers a wide selection of in-graded leathers and textiles from Grades A through Y. We've partnered with leading manufacturers on the options, focusing on color, price, durability, and construction. To view our partners and explore our digital carded program with broadly approved textiles, visit [this page](#). We stand by these textiles: They're tried and tested, and will effortlessly fit into any design aesthetic.

Textile Approvals

All textiles must be approved for the product you are specifying. For the related approved textile lists, visit [this page](#).

CAL 117 AND 133 COMPLIANCE

CAL 117-2013

CAL 117-2013 compliance is a requirement for all textiles applied on our seating products. All Stylex seating products meet this standard.

CAL 133

Most Stylex seating can be ordered to meet the requirements of CAL 133. When ordering, simply specify "CAL 133 compliance required". The upcharge for this option is \$54 list per yard. Please refer to the COM yardage of each model to determine the number of yards required. We do frequently require full-scale burn tests in order to certify CAL 133 before an order will be accepted. Such burn tests may increase normal lead times and do carry additional charges. Please contact your Stylex account manager for details.

CUSTOMER'S OWN MATERIAL/LEATHER

Customer's own material (COM) and customer's own leather (COL) will generally be upholstered at the price designated in each product's price list. Please be advised, however, that we specifically reserve the right to charge a higher price when we determine that special circumstances, such as unusual repeats or challenging materials, present themselves. All orders for custom coverings must be approved by Stylex before they will be accepted for production. To submit proposed textile for approval, please use the COM form [here](#).

Special Note:

We assume no responsibility for the durability or tailoring quality of any COM or COL. Directional covers in particular may not meet your satisfaction due to the design of certain products. Please be advised that COM and COL orders are not subject to return. If you have doubts about the ultimate appearance of certain coverings, please order a sample done with that specific COM or COL. In addition, while we inspect fabrics for mill imperfections, some are difficult to recognize. We cannot be responsible for defects, color inaccuracies, dye lot variations, or other flaws.

Under no circumstances will we be responsible for COM shortages, flaws, or other such problems. Finally, it is not our responsibility to police the receipt of COM's in order to meet delivery deadlines, and we assume our customers are aware of any undue delay in the shipment of their COM fabrics.

COM fabric and COL leather should be sent prepaid to: Stylex

**Attn: COM/COL - [Your Stylex PO #]
740 Coopertown Road
Delanco, NJ 08075**

All COM/COL sent to Stylex must be accompanied with a packing list which indicates the dealers' name, Stylex corresponding PO number, sales order number, COM/COL supplier name, textile pattern, colorway and shipped quantity. Stylex requires COM to be sent in as continuous yardage in the same dielot.

Yardage requirements shown in the price list are based on non-directional goods of 54" width. Fabrics less than 54" wide or those requiring matching (stripes, prints, or large patterned designs) call for additional yardage. We will be happy to supply yardage requirements for large quantities where economies may be realized.

Add the following yardage for stripes, plaids, or patterns with repeats:

Fabric Width	Plain Fabric	2-14" Repeat	15-24" Repeat	25-27" Repeat	28-36" Repeat
54"	0%	10%	15%	20%	25%
50"	10%	20%	25%	30%	35%
48"	15%	25%	30%	35%	40%
45"	40%	50%	55%	60%	65%
36"	50%	60%	65%	70%	75%

COM/COL FORM

To avoid delay in processing COM orders we request that you submit a sample of your COM textile stapled to this form which can be downloaded [here](#). If a textile has a stripe or design, the size of the repeat should be indicated. Please indicate the textile supplier's name, textile number, and color. Also indicate the Stylex product on which the textile will be used. If a certain direction of application is required, please ensure that information is communicated directly to your Stylex account manager.

The fabric supplier must indicate on his shipping labels the dealer name and purchase order number as well as the Stylex model number.

Please Note:

No order may be entered into production or have a shipping date assigned until all related COM is received at the factory.



CENTER OF STRIPE OR DESIGN

TOP OF CHAIR	TOP OF CHAIR
--------------	--------------

1. Size of Repeat

2. Textile Supplier

3. Textile Number

4. Color

5. Stylex Product

Contents

<hr/>		<hr/>	
COLORS, MATERIALS, AND FINISHES	5	STANDARD HEIGHT	9
<hr/>		<hr/>	
STATEMENT OF LINE	6	COUNTER STOOL	12
<hr/>		<hr/>	
DIMENSIONS	7	BAR STOOL	15
<hr/>		<hr/>	
HOW TO ORDER	8		
<hr/>			

CLICK THE TITLES ABOVE TO NAVIGATE THROUGH THE DOCUMENT
PRODUCT HEADERS ON SUBSEQUENT PAGES LINK BACK TO THIS PAGE

F4

COLORS, MATERIALS, AND FINISHES

POWDER COATED & POLISHED METAL

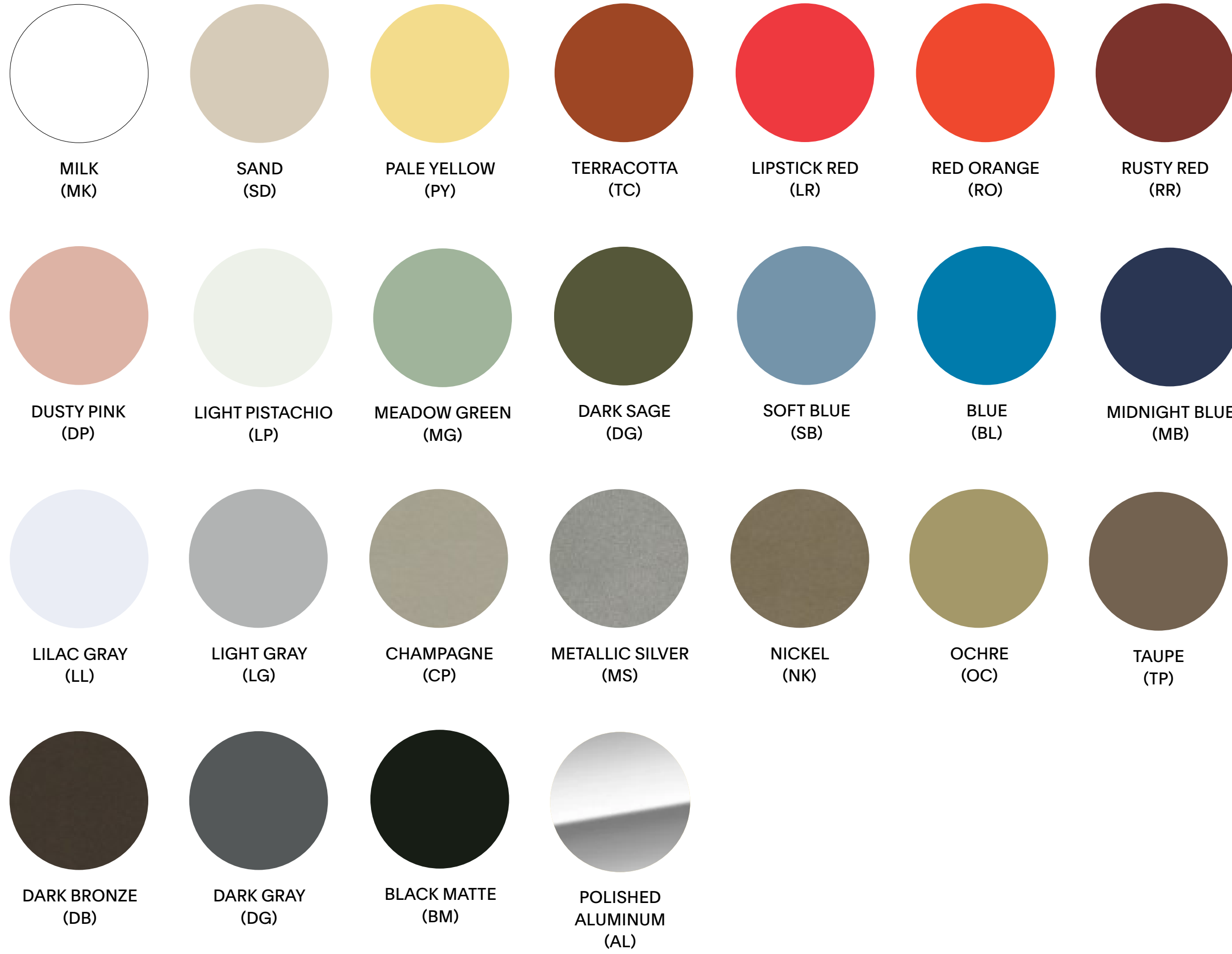

MESH BACK & KNIT SEAT



BACK FRAME







WOOD ARMS

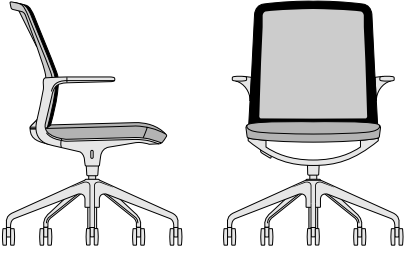
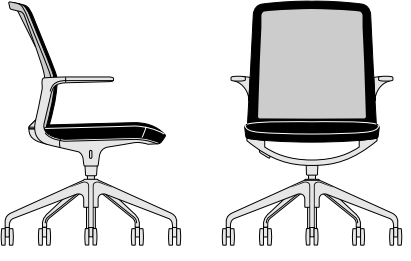
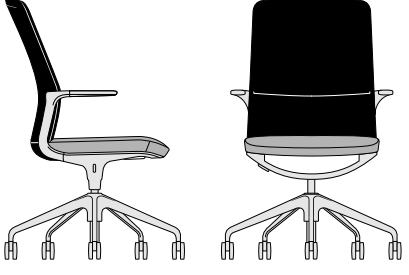
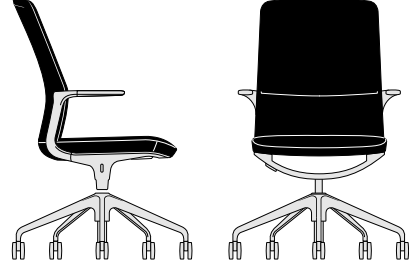
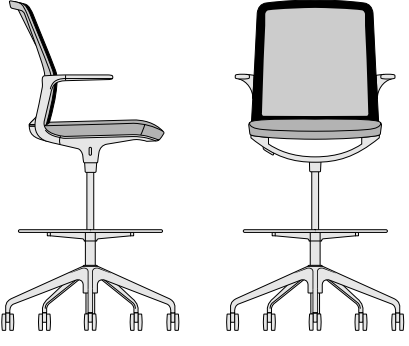
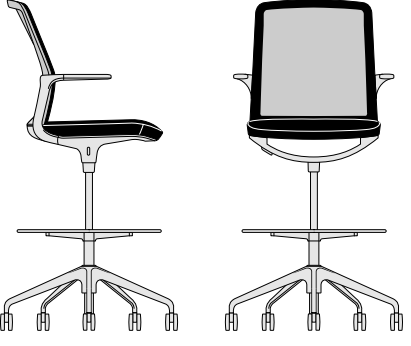
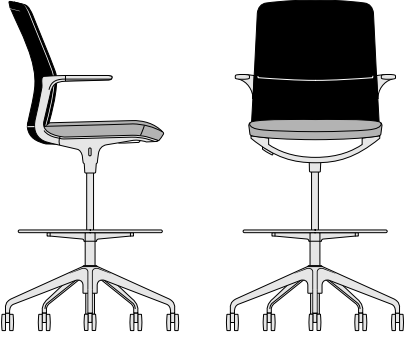

F4

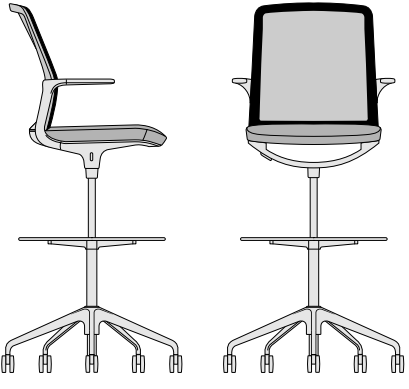
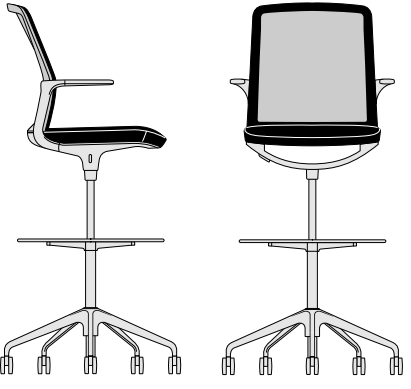
SPECIFICATION GUIDE: STATEMENT OF LINE

OVERVIEW	MESH BACK/KNIT SEAT	MESH BACK/UPHOLSTERED SEAT	UPHOLSTERED BACK/KNIT SEAT	FULLY UPHOLSTERED
Standard Height Arm or Armless	Medium Back 	Medium Back 	Medium or High Back 	Medium or High Back 
Counter Stool Arm or Armless	Medium Back 	Medium Back 	Medium or High Back 	Medium or High Back 
Bar Stool Arm or Armless	Medium Back 	Medium Back 	Medium or High Back 	Medium or High Back 

OPTIONS

Contrasting Thread

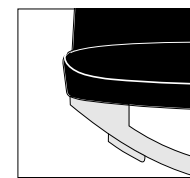

Dual Upholstered Seat and Back

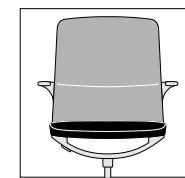

Decorative Upholstery

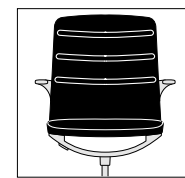

Arm Caps

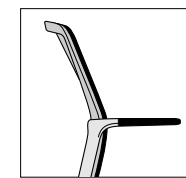

PRODUCT INFORMATION

Design
Fig 40

Back Construction

Upholstered backs utilize an internal frame of welded steel rod integrated with a flexible B-surface material and covered with polyurethane foam.

Mesh backs have injection-molded, glass-filled frames to which the mesh is applied.

Seat Construction

Both upholstered and knit seats incorporate a flexible polypropylene seat pan on which is placed a dual-density cushion of molded, CFC-free foam.

The mechanism, comprised primarily of steel and aluminum, has fixed tension with movement controlled by two series of leaf springs, one on either side of the seat. A height adjustment button is located on the right side of the cast aluminum yoke supporting the seat pan.

Bases

Bases are produced from cast aluminum and have five blades. Casters are available in black, gray, and chrome trim, all in carpet or soft wheel versions.

Use

Designed for indoor use only.

Performance Standards

Manufactured to comply with:
ANSI/BIFMA X5.1 General-Purpose Office Chairs - Tests

Certifications

GREENGUARD Gold
LEVEL® 2

F4

SPECIFICATION GUIDE: DIMENSIONS

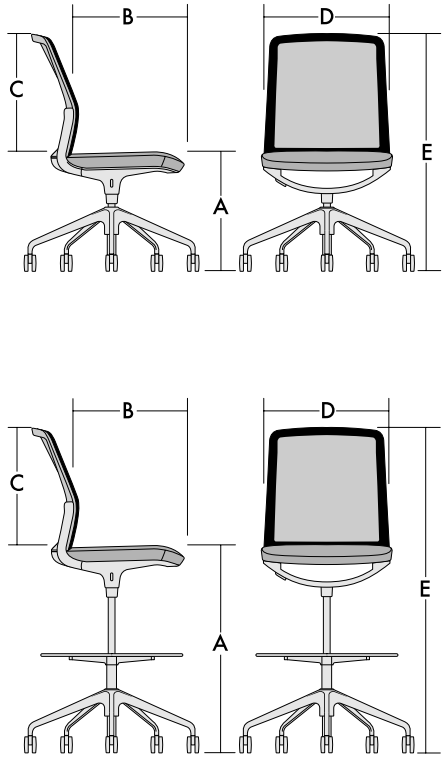
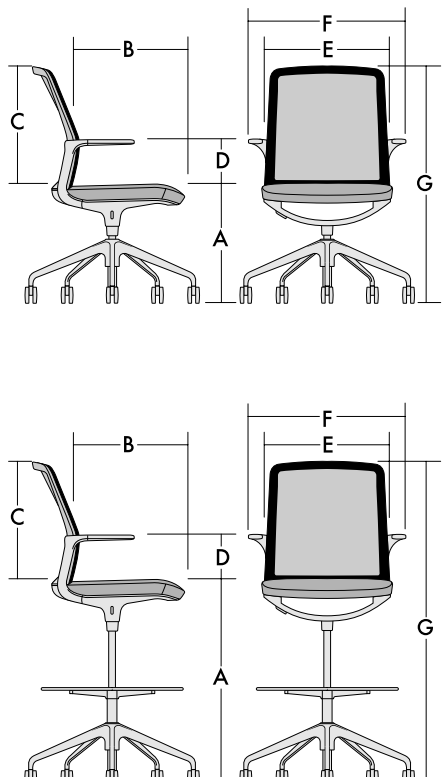
DIMENSIONS	STANDARD HEIGHT		COUNTER STOOL		BAR STOOL	
<p>Armless Models</p> <p>A. Seat Height B. Seat Depth C. Back Height D. Seat Width E. Maximum Overall Height</p> 	<p>Medium Back</p> <p>A. 17.75 - 22.75 B. 17 C. 18 D. 19.5 E. 36 - 41</p>	<p>High Back</p> <p>A. 17.75 - 22.75 B. 17 C. 20.5 D. 19.5 E. 38.5 - 43.5</p>	<p>Medium Back</p> <p>A. 24 - 31.5 B. 17 C. 18 D. 19.5 E. 42.25 - 49.75</p>	<p>High Back</p> <p>A. 24 - 31.5 B. 17 C. 20.5 D. 19.5 E. 44.75 - 52.25</p>	<p>Medium Back</p> <p>A. 26.5 - 36.5 B. 17 C. 18 D. 19.5 E. 44.75 - 54.75</p>	<p>High Back</p> <p>A. 26.5 - 36.5 B. 17 C. 20.5 D. 19.5 E. 49.25 - 57.25</p>
<p>Arm Models</p> <p>A. Seat Height B. Seat Depth C. Back Height D. Arm Height E. Back Width F. Overall Arm Width G. Maximum Overall Height</p> 	<p>Medium Back</p> <p>A. 17.75 - 22.75 B. 17 C. 18 D. 6.75 E. 17.25 F. 24 G. 36 - 41</p>	<p>High Back</p> <p>A. 17.75 - 22.75 B. 17 C. 20.5 D. 6.75 E. 17.25 F. 24 G. 38.5 - 43.5</p>	<p>Medium Back</p> <p>A. 24 - 31.5 B. 17 C. 18 D. 6.75 E. 17.25 F. 24 G. 42.25 - 49.75</p>	<p>High Back</p> <p>A. 24 - 31.5 B. 17 C. 20.5 D. 6.75 E. 17.25 F. 24 G. 44.75 - 52.25</p>	<p>Medium Back</p> <p>A. 26.5 - 36.5 B. 17 C. 18 D. 6.75 E. 17.25 F. 24 G. 44.75 - 54.75</p>	<p>High Back</p> <p>A. 26.5 - 36.5 B. 17 C. 20.5 D. 6.75 E. 17.25 F. 24 G. 49.25 - 57.25</p>

F4

SPECIFICATION GUIDE: HOW TO ORDER

MODEL CODE BREAKDOWN

Sample Model Code: F262MBCA1ALB1T11CTM01COM

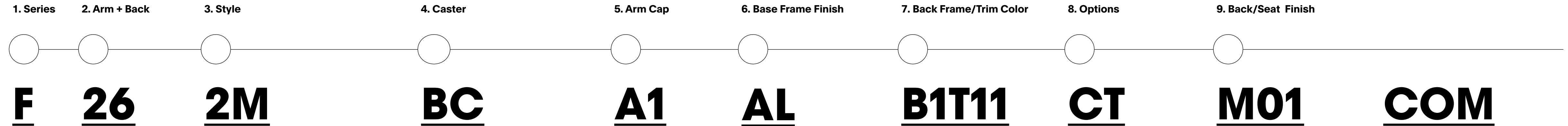

1. Series	2. Arm + Back	3. Style	4. Caster	5. Arm Cap	6. Base Frame Finish	7. Back Frame/Trim Color	8. Options	9. Back/Seat Finish	
F	26	2M	BC	A1	AL	B1T11	CT	M01	COM
Series F F4	Arm 1 ARMLESS 2 ARM Back 6 MEDIUM BACK 8 HIGH BACK	Style Standard Height 1 MESH BACK, KNIT SEAT 2 MESH BACK, UPHOLSTERED SEAT 3 UPHOLSTERED BACK, KNIT SEAT 4 FULLY UPHOLSTERED 4DF DUAL UPHOLSTERY Counter Stool 1M MESH BACK, KNIT SEAT 2M MESH BACK, UPHOLSTERED SEAT 3M UPHOLSTERED BACK, KNIT SEAT 4M FULLY UPHOLSTERED 4MDF DUAL UPHOLSTERY Bar Stool 1H MESH BACK, KNIT SEAT 2H MESH BACK, UPHOLSTERED SEAT 3H UPHOLSTERED BACK, KNIT SEAT 4H FULLY UPHOLSTERED 4HDF DUAL UPHOLSTERY	Casters Black Casters BC BLACK CARPET CASTERS BS BLACK SOFT CASTERS Chrome Casters CC CHROME TRIM CASTERS CS CHROME TRIM SOFT CASTERS Gray Casters GC GRAY CARPET CASTERS GS GRAY SOFT CASTERS	Arm Cap Polyurethane A1 BLACK A2 GRAY Wood 81 WHITE OAK 85 WALNUT Aluminum 70 ALUMINUM	Base Frame Color Standard Powder Coat BL BLUE BM BLACK MATTE CP CHAMPAGNE DB DARK BRONZE DG DARK GRAY DP DUSTY PINK DS DARK SAGE LG LIGHT GRAY LL LILAC GRAY LP LIGHT PISTACHIO LR LIPSTICK RED MB MIDNIGHT BLUE MG MEADOW GREEN MK MILK MS METALLIC SILVER NK NICKEL OC OCHRE PY PALE YELLOW RO RED ORANGE RR RUSTY RED SB SOFT BLUE SD SAND TC TERRACOTTA TP TAUPE Chrome AL POLISHED ALUMINUM	Back Frame B1 BLACK B2 GRAY B3 WHITE Trim Color T01 CHROME CYLINDER BLACK CAP, BUTTON T11 ALL BLACK T22 ALL GRAY T31 WHITE CYLINDER, BLACK CAP, BUTTON T32 WHITE CYLINDER, GRAY CAP, BUTTON	Options HL HEIGHT LOCK CT CONTRASTING THREAD Decorative Upholstery D1 CHANNEL D2 LOOP	Mesh Back Color M01 BLACK M02 GRAPHITE M03 SMOKE M05 WHITE M13 POPPY M15 MIDNIGHT BLUE M22 BLACK/SMOKE M23 BLACK/BRONZE M26 BLACK/MIDNIGHT BLUE M27 BLACK/RED M28 WHITE/SMOKE Knit Seat Color K01 BLACK K02 GRAPHITE K03 SMOKE K13 POPPY K15 MIDNIGHT BLUE K22 BLACK/SMOKE K23 BLACK/BRONZE K26 MIDNIGHT BLUE/BLACK K27 RED/BLACK K28 WHITE/SMOKE	Textile Grades COM CUSTOMER'S OWN MATERIAL A GRADE A B GRADE B C GRADE C D GRADE D E GRADE E F GRADE F G GRADE G H GRADE H I GRADE I J GRADE J K GRADE K L GRADE L M GRADE M Leather Grades COL CUSTOMER'S OWN LEATHER W GRADE W X GRADE X Y GRADE Y E1 GRADE E1 E2 GRADE E2

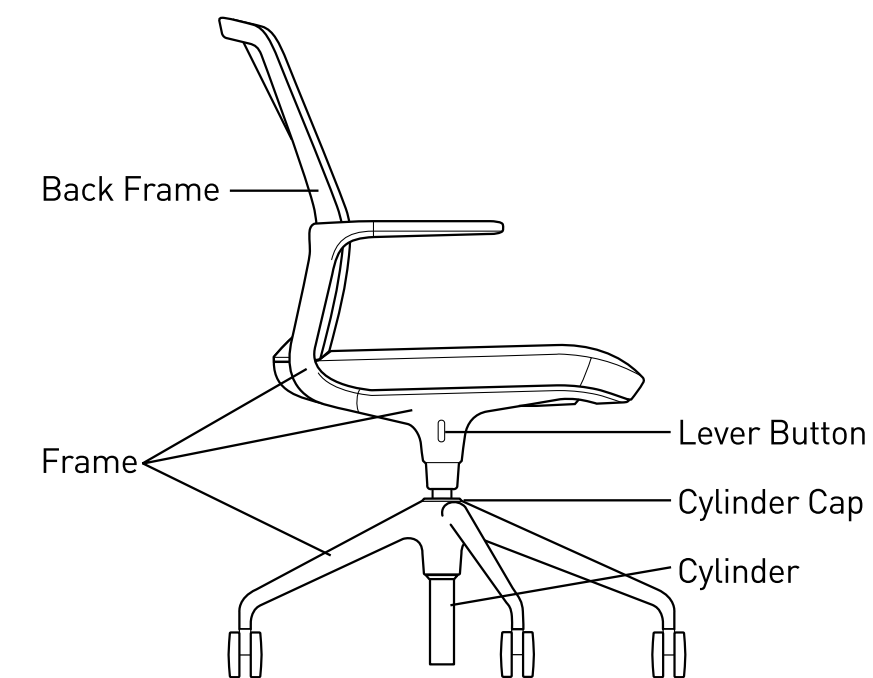

Note: Select highest grade in the case of dual upholstery

F4

STANDARD HEIGHT: MESH BACK

TITLE	SERIES	ARM	BACK	UPH	HEIGHT	DIMENSIONS	YDG	SQFT	Textile Upholstery Grades												Leather Upholstery Grades							
									COM	COL	COM	A	B	COL	C	D	E	F	G	H	I	J	K	L	M	W	X	Y
Standard Height, Mesh Back and Knit Seat, Medium Back, Arm	F	2	6	1		24W x 26D x 36 - 41H	0	0	1,306																			
Standard Height, Mesh Back and Knit Seat, Medium Back, Armless	F	1	6	1		19.5W x 26D x 36 - 41H	0	0	1,279																			
Standard Height, Mesh Back and Upholstered Seat, Medium Back, Arm	F	2	6	2		24W x 26D x 36 - 41H	0.8	9	1,269	1,326	1,358	1,389	1,419	1,453	1,487	1,522	1,562	1,615	1,679	1,741	1,805	1,868	1,552	1,613	1,806	1,887	2,106	
Standard Height, Mesh Back and Upholstered Seat, Medium Back, Armless	F	1	6	2		19.5W x 26D x 36 - 41H	0.8	9	1,242	1,298	1,331	1,361	1,392	1,425	1,460	1,493	1,534	1,588	1,652	1,713	1,777	1,840	1,525	1,586	1,778	1,860	2,079	

To Order Select Below

1. Series/Arm/Back/Style

	F261
F4 Standard Height, Mesh Back and Knit Seat Medium Back, Arm	
F161	
F4 Standard Height, Mesh Back and Knit Seat Medium Back, Armless	
F262	
F4 Standard Height, Mesh Back and Upholstered Seat Medium Back, Arm	
F162	
F4 Standard Height, Mesh Back and Upholstered Seat Medium Back, Armless	

2. Casters

	Hard Casters
BC	HARD, BLACK
GC	HARD, GRAY +29
CC	HARD, CHROME TRIM +102
	Soft Casters
BS	SOFT, BLACK +44
GS	SOFT, GRAY +55
CS	SOFT, CHROME TRIM +128

3. Arm Cap

	Polyurethane
A1	BLACK
A2	GRAY
	Wood
81	WHITE OAK +234
85	WALNUT +234
	Aluminum
70	ALUMINUM +85

Aluminum arm caps match the chosen frame finish

4. Base Frame Finish

	Standard Powder Coated Metal	+105
BL	BLUE	
BM	BLACK MATTE	
CP	CHAMPAGNE	
DB	DARK BRONZE	
DG	DARK GRAY	
DP	DUSTY PINK	
DS	DARK SAGE	
LG	LIGHT GRAY	
LL	LILAC GRAY	
LP	LIGHT PISTACHIO	
LR	LIPSTICK RED	
MB	MIDNIGHT BLUE	
	Polished Metal	
AL	POLISHED ALUMINUM	

5. Back Frame/Trim Color

	Back Frame
B1	BLACK
B2	GRAY
B3	WHITE
	Trim Color
T01	CHROME CYLINDER, BLACK CAP, BUTTON
T11	ALL BLACK
T22	ALL GRAY
T31	WHITE CYLINDER, BLACK CAP, BUTTON
T32	WHITE CYLINDER, GRAY CAP, BUTTON

6. Options

	Options
HL	HEIGHT LOCK
CT	CONTRASTING THREAD

7. Back/Seat Choice

	Mesh Back Color
M01	BLACK
M02	GRAPHITE
M03	SMOKE
M05	WHITE
M13	POPPY
M15	MIDNIGHT BLUE
	Knit Seat Color
K01	BLACK
K02	GRAPHITE
K03	SMOKE
K13	POPPY
K15	MIDNIGHT BLUE
M22	BLACK/SMOKE
M23	BLACK/BRONZE
M26	BLACK/MIDNIGHT BLUE
M27	BLACK/RED
M28	WHITE/SMOKE
K22	BLACK/SMOKE
K23	BLACK/BRONZE
K26	BLACK/MIDNIGHT BLUE
K27	BLACK/RED

Upholstery
See general information section for details on textile program and COM/COL information.



F4

STANDARD HEIGHT: UPHOLSTERED BACK/KNIT SEAT



TITLE	SERIES	ARM	BACK	UPH	HEIGHT	DIMENSIONS	YDG	SQFT	Textile Upholstery Grades												Leather Upholstery Grades						
									COM	COL	COM	A	B	COL	C	D	E	F	G	H	I	J	K	L	M	W	X
Standard Height, Upholstered Back and Knit Seat, Medium Back, Arm	F	2	6	3		24W x 26D x 36 - 41H	0.8	11	1,709	1,768	1,802	1,832	1,865	1,898	1,934	1,971	2,012	2,066	2,131	2,196	2,259	2,324	2,028	2,105	2,352	2,458	2,696
Standard Height, Upholstered Back and Knit Seat, Medium Back, Armless	F	1	6	3		19.5W x 26D x 36 - 41H	0.8	11	1,682	1,741	1,774	1,805	1,838	1,871	1,906	1,944	1,985	2,038	2,103	2,168	2,232	2,297	2,001	2,078	2,324	2,429	2,669
Standard Height, Upholstered Back and Knit Seat, High Back, Arm	F	2	8	3		24W x 26D x 38.5 - 43.5H	1	15	1,828	1,904	1,946	1,986	2,030	2,073	2,117	2,163	2,218	2,287	2,372	2,455	2,538	2,621	2,149	2,225	2,474	2,577	2,816
Standard Height, Upholstered Back and Knit Seat, High Back, Armless	F	1	8	3		19.5W x 26D x 38.5 - 43.5H	1	15	1,800	1,877	1,919	1,959	2,003	2,046	2,090	2,136	2,190	2,259	2,344	2,428	2,511	2,594	2,122	2,198	2,447	2,550	2,789

To Order Select Below





1. Series/Arm/Back/Style

	
F263	F4 Standard Height, Upholstered Back and Knit Seat Medium Back, Arm
F163	F4 Standard Height, Upholstered Back and Knit Seat Medium Back, Armless
F283	F4 Standard Height, Upholstered Back and Knit Seat High Back, Arm
F183	F4 Standard Height, Upholstered Back and Knit Seat High Back, Armless

2. Casters

		Hard Casters
BC	HARD, BLACK	
GC	HARD, GRAY	+29
CC	HARD, CHROME TRIM	+102
	Soft Casters	
BS	SOFT, BLACK	+44
GS	SOFT, GRAY	+55
CS	SOFT, CHROME TRIM	+128

3. Arm Cap



		Polyurethane
A1	BLACK	
A2	GRAY	
	Wood	
81	WHITE OAK	+234
85	WALNUT	+234
	Aluminum	
70	ALUMINUM	+85

Aluminum arm caps match the chosen frame finish



4. Base Frame Finish

		Standard Powder Coated Metal	+105
BL	BLUE	MG	MEADOW GREEN
BM	BLACK MATTE	MK	MILK
CP	CHAMPAGNE	MS	METALLIC SILVER
DB	DARK BRONZE	NK	NICKEL
DG	DARK GRAY	OC	OCHRE
DP	DUSTY PINK	PY	PALE YELLOW
DS	DARK SAGE	RO	RED ORANGE
LG	LIGHT GRAY	RR	RUSTY RED
LL	LILAC GRAY	SB	SOFT BLUE
LP	LIGHT PISTACHIO	SD	SAND
LR	LIPSTICK RED	TC	TERRACOTTA
MB	MIDNIGHT BLUE	TP	TAUPE
	Polished Metal		
AL	POLISHED ALUMINUM		

5. Trim Color

		Trim Color
	CHROME CYLINDER, BLACK CAP, BUTTON	T01
	ALL BLACK	T11
	ALL GRAY	T22
	WHITE CYLINDER, BLACK CAP, BUTTON	T31
	WHITE CYLINDER, GRAY CAP, BUTTON	T32

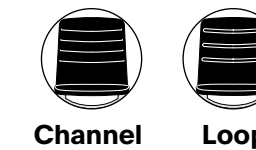

6. Options

		Options
HL	HEIGHT LOCK	
	CONTRASTING THREAD	CT
	Decorative Upholstery	
D1	CHANNEL	+146
D2	LOOP	+146



Channel Loop

7. Back/Seat Choice

		Knit Seat Color	
K01	BLACK	K22	BLACK/SMOKE
K02	GRAPHITE	K23	BLACK/BRONZE
K03	SMOKE	K26	BLACK/MIDNIGHT BLUE
K13	POPPY	K27	BLACK/RED
K15	MIDNIGHT BLUE		

Upholstery

See general information section for details on textile program and COM/COL information.

F4

STANDARD HEIGHT: FULLY UPHOLSTERED

TITLE	SERIES	ARM	BACK	UPH	HEIGHT	DIMENSIONS	YDG	SQFT	Textile Upholstery Grades										Leather Upholstery Grades								
									COM	COL	COM	A	B	COL	C	D	E	F	G	H	I	J	K	L	M	W	X
Standard Height, Fully Upholstered, Medium Back, Arm	F	2	6	4		24W x 26D x 36 - 41H	1.6	20	1,709	1,828	1,894	1,957	2,022	2,087	2,159	2,228	2,313	2,424	2,554	2,684	2,811	2,942	2,257	2,396	2,838	3,021	3,480
Standard Height, Fully Upholstered, Medium Back, Armless	F	1	6	4		19.5W x 26D x 36 - 41H	1.6	20	1,682	1,800	1,866	1,929	1,994	2,059	2,132	2,201	2,286	2,397	2,527	2,657	2,783	2,914	2,230	2,368	2,811	2,994	3,453
Standard Height, Fully Upholstered, High Back, Arm	F	2	8	4		24W x 26D x 38.5 - 43.5H	1.8	23	1,828	1,965	2,038	2,112	2,184	2,259	2,341	2,425	2,520	2,646	2,793	2,942	3,089	3,236	2,381	2,517	2,960	3,144	3,602
Standard Height, Fully Upholstered, High Back, Armless	F	1	8	4		19.5W x 26D x 38.5 - 43.5H	1.8	23	1,800	1,938	2,011	2,084	2,157	2,232	2,314	2,398	2,493	2,619	2,766	2,914	3,062	3,209	2,354	2,490	2,932	3,117	3,574

To Order Select Below

1. Series/Arm/Back/Style

- F264
F4 Standard Height, Fully Upholstered Medium Back, Arm
- F164
F4 Standard Height, Fully Upholstered Medium Back, Armless
- F284
F4 Standard Height, Fully Upholstered High Back, Arm
- F184
F4 Standard Height, Fully Upholstered High Back, Armless

Dual Upholstery

DF DUAL UPHOLSTERY

2. Casters

Hard Casters

BC HARD, BLACK
GC HARD, GRAY **+29**
CC HARD, CHROME TRIM **+102**

Soft Casters

BS SOFT, BLACK **+44**
GS SOFT, GRAY **+55**
CS SOFT, CHROME TRIM **+128**

3. Arm Cap

Polyurethane

A1 BLACK
A2 GRAY

Wood

81 WHITE OAK **+234**
85 WALNUT **+234**

Aluminum

70 ALUMINUM **+85**

Aluminum arm caps match the chosen frame finish

4. Base Frame Finish

Standard Powder Coated Metal **+105**

BL BLUE
BM BLACK MATTE
CP CHAMPAGNE
DB DARK BRONZE
DG DARK GRAY
DP DUSTY PINK
DS DARK SAGE
LG LIGHT GRAY
LL LILAC GRAY
LP LIGHT PISTACHIO
LR LIPSTICK RED
MB MIDNIGHT BLUE
MG MEADOW GREEN
MK MILK
MS METALLIC SILVER
NK NICKEL
OC OCHRE
PY PALE YELLOW
RO RED ORANGE
RR RUSTY RED
SB SOFT BLUE
SD SAND
TC TERRACOTTA
TP TAUPE

Polished Metal

AL POLISHED ALUMINUM

5. Trim Color

Trim Color

T01 CHROME CYLINDER, BLACK CAP, BUTTON
T11 ALL BLACK
T22 ALL GRAY
T31 WHITE CYLINDER, BLACK CAP, BUTTON
T32 WHITE CYLINDER, GRAY CAP, BUTTON

6. Options

Options

HL HEIGHT LOCK
CT CONTRASTING THREAD

Decorative Upholstery

D1 CHANNEL **+146**
D2 LOOP **+146**

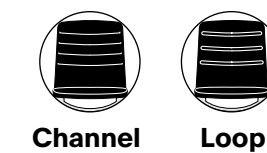

Channel Loop

7. Back/Seat Choice

Upholstery

See general information section for details on textile program and COM/COL information.

When pricing models with more than one fabric, the higher grade fabric will determine the overall grade of the specific product.

F4

COUNTER STOOL: MESH BACK

TITLE	SERIES	ARM	BACK	UPH	HEIGHT	DIMENSIONS	YDG	SQFT	Textile Upholstery Grades												Leather Upholstery Grades							
									COM	COL	COM	A	B	COL	C	D	E	F	G	H	I	J	K	L	M	W	X	Y
Counter Stool, Mesh Back and Knit Seat, Medium Back, Arm	F	2	6	1	M	24W x 26D x 42.25 - 49.75H	0	0	1,472																			
Counter Stool, Mesh Back and Knit Seat, Medium Back, Armless	F	1	6	1	M	19.5W x 26D x 42.25 - 49.75H	0	0	1,445																			
Counter Stool, Mesh Back and Upholstered Seat, Medium Back, Arm	F	2	6	2	M	24W x 26D x 42.25 - 49.75H	0.8	9	1,435	1,491	1,525	1,555	1,585	1,618	1,654	1,687	1,727	1,782	1,844	1,906	1,971	2,033	1,718	1,778	1,972	2,053	2,272	
Counter Stool, Mesh Back and Upholstered Seat, Medium Back, Armless	F	1	6	2	M	19.5W x 26D x 42.25 - 49.75H	0.8	9	1,407	1,464	1,498	1,528	1,557	1,591	1,626	1,660	1,700	1,753	1,817	1,879	1,944	2,006	1,690	1,751	1,945	2,026	2,245	

To Order Select Below

1. Series/Arm/Back/Style

	F261M
	F4 Counter Stool, Mesh Back and Knit Seat Medium Back, Arm
	F161M
	F4 Counter Stool, Mesh Back and Knit Seat Medium Back, Armless
	F262M
	F4 Counter Stool, Mesh Back and Upholstered Seat Medium Back, Arm
	F162M
	F4 Counter Stool, Mesh Back and Upholstered Seat Medium Back, Armless

2. Casters

	Hard Casters
BC	HARD, BLACK
GC	HARD, GRAY +29
CC	HARD, CHROME TRIM +102
	Soft Casters
BS	SOFT, BLACK +44
GS	SOFT, GRAY +55
CS	SOFT, CHROME TRIM +128

3. Arm Cap

	Polyurethane
A1	BLACK
A2	GRAY
	Wood
81	WHITE OAK +234
85	WALNUT +234
	Aluminum
70	ALUMINUM +85

Aluminum arm caps match the chosen frame finish

4. Base Frame Finish

	Standard Powder Coated Metal	+105
BL	BLUE	
BM	BLACK MATTE	
CP	CHAMPAGNE	
DB	DARK BRONZE	
DG	DARK GRAY	
DP	DUSTY PINK	
DS	DARK SAGE	
LG	LIGHT GRAY	
LL	LILAC GRAY	
LP	LIGHT PISTACHIO	
LR	LIPSTICK RED	
MB	MIDNIGHT BLUE	
	Polished Metal	
AL	POLISHED ALUMINUM	

5. Back Frame/Trim Color

	Back Frame
B1	BLACK
B2	GRAY
B3	WHITE
	Trim Color
T01	CHROME CYLINDER, BLACK CAP, BUTTON
T11	ALL BLACK
T22	ALL GRAY
T31	WHITE CYLINDER, BLACK CAP, BUTTON
T32	WHITE CYLINDER, GRAY CAP, BUTTON

6. Options

	Options
HL	HEIGHT LOCK
CT	CONTRASTING THREAD

7. Back/Seat Choice

	Mesh Back Color
M01	BLACK
M02	GRAPHITE
M03	SMOKE
M05	WHITE
M13	POPPY
M15	MIDNIGHT BLUE
	Knit Seat Color
K01	BLACK
K02	GRAPHITE
K03	SMOKE
K13	POPPY
K15	MIDNIGHT BLUE
M22	BLACK/SMOKE
M23	BLACK/BRONZE
M26	BLACK/MIDNIGHT BLUE
M27	BLACK/RED
M28	WHITE/SMOKE
K22	BLACK/SMOKE
K23	BLACK/BRONZE
K26	BLACK/MIDNIGHT BLUE
K27	BLACK/RED

Upholstery

See general information section for details on textile program and COM/COL information.

F4

COUNTER STOOL: UPHOLSTERED BACK/KNIT SEAT



TITLE	SERIES	ARM	BACK	UPH	HEIGHT	DIMENSIONS	YDG	SQFT	Textile Upholstery Grades												Leather Upholstery Grades						
									COM	COL	COM	A	B	COL	C	D	E	F	G	H	I	J	K	L	M	W	X
Counter Stool, Upholstered Back and Knit Seat, Medium Back, Arm	F	2	6	3	M	24W x 26D x 42.25 - 49.75H	0.8	11	1,875	1,934	1,968	1,999	2,031	2,064	2,100	2,137	2,179	2,232	2,296	2,362	2,425	2,491	2,193	2,271	2,518	2,623	2,862
Counter Stool, Upholstered Back and Knit Seat, Medium Back, Armless	F	1	6	3	M	19.5W x 26D x 42.25 - 49.75H	0.8	11	1,848	1,906	1,941	1,971	2,004	2,036	2,073	2,110	2,152	2,205	2,269	2,335	2,398	2,464	2,166	2,244	2,491	2,596	2,835
Counter Stool, Upholstered Back and Knit Seat, High Back, Arm	F	2	8	3	M	24W x 26D x 44.75 - 52.25H	1	15	1,994	2,071	2,112	2,153	2,196	2,239	2,284	2,330	2,384	2,452	2,538	2,622	2,704	2,787	2,315	2,390	2,641	2,744	2,983
Counter Stool, Upholstered Back and Knit Seat, High Back, Armless	F	1	8	3	M	19.5W x 26D x 44.75 - 52.25H	1	15	1,967	2,044	2,084	2,125	2,168	2,211	2,256	2,302	2,357	2,425	2,511	2,595	2,677	2,759	2,288	2,363	2,614	2,715	2,955

To Order Select Below



1. Series/Arm/Back/Style

	
F263M	F4 Counter Stool, Upholstered Back and Knit Seat Medium Back, Arm
F163M	F4 Counter Stool, Upholstered Back and Knit Seat Medium Back, Armless
F283M	F4 Counter Stool, Upholstered Back and Knit Seat High Back, Arm
F183M	F4 Counter Stool, Upholstered Back and Knit Seat High Back, Armless

2. Casters

	
Hard Casters	
BC	HARD, BLACK
GC	HARD, GRAY +29
CC	HARD, CHROME TRIM +102
Soft Casters	
BS	SOFT, BLACK +44
GS	SOFT, GRAY +55
CS	SOFT, CHROME TRIM +128

3. Arm Cap



	
Polyurethane	
A1	BLACK
A2	GRAY
Wood	
81	WHITE OAK +234
85	WALNUT +234
Aluminum	
70	ALUMINUM +85

Aluminum arm caps match the chosen frame finish



4. Base Frame Finish

	
Standard Powder Coated Metal	+105
BL	BLUE
BM	BLACK MATTE
CP	CHAMPAGNE
DB	DARK BRONZE
DG	DARK GRAY
DP	DUSTY PINK
DS	DARK SAGE
LG	LIGHT GRAY
LL	LILAC GRAY
LP	LIGHT PISTACHIO
LR	LIPSTICK RED
MB	MIDNIGHT BLUE
Polished Metal	
AL	POLISHED ALUMINUM



5. Trim Color

	
Trim Color	
	CHROME CYLINDER, BLACK CAP, BUTTON
T01	
T11	ALL BLACK
T22	ALL GRAY
	WHITE CYLINDER, BLACK CAP, BUTTON
T31	
	WHITE CYLINDER, GRAY CAP, BUTTON
T32	

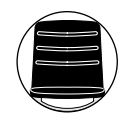
6. Options





	
Options	
HL	HEIGHT LOCK
	CONTRASTING THREAD
CT	
Decorative Upholstery	
D1	CHANNEL +146
D2	LOOP +146
	
Channel	Loop

7. Back/Seat Choice

	
Knit Seat Color	
K01	BLACK
K02	GRAPHITE
K03	SMOKE
K13	POPPY
K15	MIDNIGHT BLUE
K22	BLACK/SMOKE
K23	BLACK/BRONZE
K26	BLACK/MIDNIGHT BLUE
K27	BLACK/RED
Upholstery	
See general information section for details on textile program and COM/COL information.	

F4

COUNTER STOOL: FULLY UPHOLSTERED

TITLE	SERIES	ARM	BACK	UPH	HEIGHT	DIMENSIONS	YDG	SQFT	Textile Upholstery Grades										Leather Upholstery Grades								
									COM	COL	COM	A	B	COL	C	D	E	F	G	H	I	J	K	L	M	W	X
 Counter Stool, Fully Upholstered, Medium Back, Arm	F	2	6	4	M	24W x 26D x 42.25 - 49.75H	1.6	20	1,875	1,994	2,059	2,123	2,187	2,253	2,324	2,394	2,479	2,591	2,721	2,851	2,976	3,108	2,423	2,562	3,005	3,188	3,646
 Counter Stool, Fully Upholstered, Medium Back, Armless	F	1	6	4	M	19.5W x 26D x 42.25 - 49.75H	1.6	20	1,848	1,967	2,032	2,096	2,160	2,226	2,297	2,366	2,451	2,563	2,693	2,823	2,949	3,080	2,396	2,534	2,976	3,161	3,619
 Counter Stool, Fully Upholstered, High Back, Arm	F	2	8	4	M	24W x 26D x 44.75 - 52.25H	1.8	23	1,994	2,131	2,205	2,278	2,350	2,425	2,507	2,592	2,686	2,812	2,960	3,108	3,255	3,403	2,547	2,683	3,125	3,310	3,768
 Counter Stool, Fully Upholstered, High Back, Armless	F	1	8	4	M	19.5W x 26D x 44.75 - 52.25H	1.8	23	1,967	2,103	2,178	2,251	2,322	2,398	2,480	2,564	2,659	2,785	2,932	3,080	3,228	3,376	2,519	2,656	3,098	3,282	3,740

To Order Select Below

1. Series/Arm/Back/Style

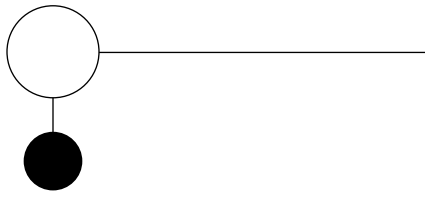

F264M

F4 Counter Stool, Fully Upholstered Medium Back, Arm

F164M

F4 Counter Stool, Fully Upholstered Medium Back, Armless

F284M

F4 Counter Stool, Fully Upholstered High Back, Arm

F184M

F4 Counter Stool, Fully Upholstered High Back, Armless

2. Casters

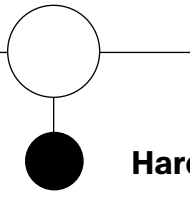

Hard Casters
 BC HARD, BLACK
 GC HARD, GRAY **+29**
 CC HARD, CHROME TRIM **+102**

Soft Casters
 BS SOFT, BLACK **+44**
 GS SOFT, GRAY **+55**
 CS SOFT, CHROME TRIM **+128**

3. Arm Cap

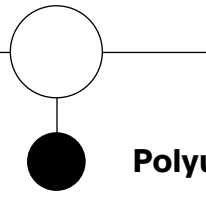

Polyurethane
 A1 BLACK
 A2 GRAY

Wood
 81 WHITE OAK **+234**
 85 WALNUT **+234**

Aluminum
 70 ALUMINUM **+85**

Aluminum arm caps match the chosen frame finish

4. Base Frame Finish

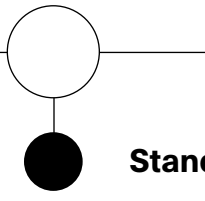

Standard Powder Coated Metal +105
 BL BLUE
 BM BLACK MATTE
 CP CHAMPAGNE
 DB DARK BRONZE
 DG DARK GRAY
 DP DUSTY PINK
 DS DARK SAGE
 LG LIGHT GRAY
 LL LILAC GRAY
 LP LIGHT PISTACHIO
 LR LIPSTICK RED
 MB MIDNIGHT BLUE
 MG MEADOW GREEN
 MK MILK
 MS METALLIC SILVER
 NK NICKEL
 OC OCHRE
 PY PALE YELLOW
 RO RED ORANGE
 RR RUSTY RED
 SB SOFT BLUE
 SD SAND
 TC TERRACOTTA
 TP TAUPE

Polished Metal
 AL POLISHED ALUMINUM

5. Trim Color

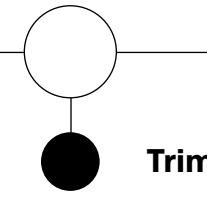

Trim Color
 CHROME CYLINDER, BLACK CAP, BUTTON
 T01
 T11 ALL BLACK
 T22 ALL GRAY
 WHITE CYLINDER, BLACK CAP, BUTTON
 T31
 WHITE CYLINDER, GRAY CAP, BUTTON
 T32

6. Options

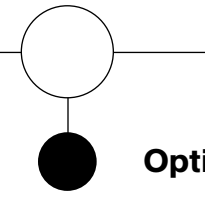

Options
 HL HEIGHT LOCK
 CONTRASTING THREAD
 CT
Decorative Upholstery
 D1 CHANNEL **+146**
 D2 LOOP **+146**

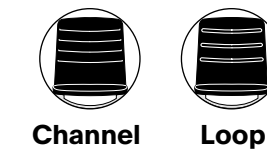

7. Back/Seat Choice

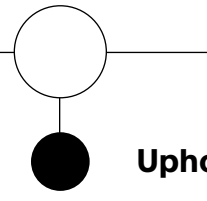

Upholstery
 See general information section for details on textile program and COM/COL information.

When pricing models with more than one fabric, the higher grade fabric will determine the overall grade of the specific product.

F4

BAR STOOL: MESH BACK

TITLE	SERIES	ARM	BACK	UPH	HEIGHT	DIMENSIONS	YDG	SQFT	Textile Upholstery Grades												Leather Upholstery Grades							
									COM	COL	COM	A	B	COL	C	D	E	F	G	H	I	J	K	L	M	W	X	Y
Bar Stool, Mesh Back and Knit Seat, Medium Back, Arm	F	2	6	1	H	24W x 26D x 44.75 - 54.75H	0	0	1,472																			
Bar Stool, Mesh Back and Knit Seat, Medium Back, Armless	F	1	6	1	H	19.5W x 26D x 44.75 - 54.75H	0	0	1,445																			
Bar Stool, Mesh Back and Upholstered Seat, Medium Back, Arm	F	2	6	2	H	24W x 26D x 44.75 - 54.75H	0.8	9	1,435	1,491	1,525	1,555	1,585	1,618	1,654	1,687	1,727	1,782	1,844	1,906	1,971	2,033	1,718	1,778	1,972	2,053	2,272	
Bar Stool, Mesh Back and Upholstered Seat, Medium Back, Armless	F	1	6	2	H	19.5W x 26D x 44.75 - 54.75H	0.8	9	1,407	1,464	1,498	1,528	1,557	1,591	1,626	1,660	1,700	1,753	1,817	1,879	1,944	2,006	1,690	1,751	1,945	2,026	2,245	

To Order Select Below

1. Series/Arm/Back/Style

- F261H
F4 Bar Stool, Mesh Back and Knit Seat Medium Back, Arm
- F161H
F4 Bar Stool, Mesh Back and Knit Seat Medium Back, Armless
- F262H
F4 Bar Stool, Mesh Back and Upholstered Seat Medium Back, Arm
- F162H
F4 Bar Stool, Mesh Back and Upholstered Seat Medium Back, Armless

2. Casters

- Hard Casters**
 - BC HARD, BLACK
 - GC HARD, GRAY **+29**
 - CC HARD, CHROME TRIM **+102**
- Soft Casters**
 - BS SOFT, BLACK **+44**
 - GS SOFT, GRAY **+55**
 - CS SOFT, CHROME TRIM **+128**

3. Arm Cap

- Polyurethane**
 - A1 BLACK
 - A2 GRAY
 - Wood**
 - 81 WHITE OAK **+234**
 - 85 WALNUT **+234**
 - Aluminum**
 - 70 ALUMINUM **+85**
- Aluminum arm caps match the chosen frame finish

4. Base Frame Finish

- Standard Powder Coated Metal +105**
 - BL BLUE
 - BM BLACK MATTE
 - CP CHAMPAGNE
 - DB DARK BRONZE
 - DG DARK GRAY
 - DP DUSTY PINK
 - DS DARK SAGE
 - LG LIGHT GRAY
 - LL LILAC GRAY
 - LP LIGHT PISTACHIO
 - LR LIPSTICK RED
 - MB MIDNIGHT BLUE
 - MG MEADOW GREEN
 - MK MILK
 - MS METALLIC SILVER
 - NK NICKEL
 - OC OCHRE
 - PY PALE YELLOW
 - RO RED ORANGE
 - RR RUSTY RED
 - SB SOFT BLUE
 - SD SAND
 - TC TERRACOTTA
 - TP TAUPE
- Polished Metal**
 - AL POLISHED ALUMINUM

5. Back Frame/Trim Color

- Back Frame**
 - B1 BLACK
 - B2 GRAY
 - B3 WHITE
- Trim Color**
 - T01 CHROME CYLINDER, BLACK CAP, BUTTON
 - T11 ALL BLACK
 - T22 ALL GRAY
 - T31 WHITE CYLINDER, BLACK CAP, BUTTON
 - T32 WHITE CYLINDER, GRAY CAP, BUTTON

6. Options

- Options**
 - HL HEIGHT LOCK
 - CT CONTRASTING THREAD





7. Back/Seat Choice

- Mesh Back Color**
 - M01 BLACK
 - M02 GRAPHITE
 - M03 SMOKE
 - M05 WHITE
 - M13 POPPY
 - M15 MIDNIGHT BLUE
 - M22 BLACK/SMOKE
 - M23 BLACK/BRONZE
 - M26 BLACK/MIDNIGHT BLUE
 - M27 BLACK/RED
 - M28 WHITE/SMOKE
- Knit Seat Color**
 - K01 BLACK
 - K02 GRAPHITE
 - K03 SMOKE
 - K13 POPPY
 - K15 MIDNIGHT BLUE
 - K22 BLACK/SMOKE
 - K23 BLACK/BRONZE
 - K26 BLACK/MIDNIGHT BLUE
 - K27 BLACK/RED

Upholstery
See general information section for details on textile program and COM/COL information.



F4

BAR STOOL: UPHOLSTERED BACK/KNIT SEAT



TITLE	SERIES	ARM	BACK	UPH	HEIGHT	DIMENSIONS	YDG	SQFT	Textile Upholstery Grades												Leather Upholstery Grades						
									COM	COL	COM	A	B	COL	C	D	E	F	G	H	I	J	K	L	M	W	X
Bar Stool, Upholstered Back and Knit Seat, Medium Back, Arm 	F	2	6	3	H	24W x 26D x 44.75 - 54.75H	0.8	11	1,875	1,934	1,968	1,999	2,031	2,064	2,100	2,137	2,179	2,232	2,296	2,362	2,425	2,491	2,193	2,271	2,518	2,623	2,862
Bar Stool, Upholstered Back and Knit Seat, Medium Back, Armless 	F	1	6	3	H	19.5W x 26D x 44.75 - 54.75H	0.8	11	1,848	1,906	1,941	1,971	2,004	2,036	2,073	2,110	2,152	2,205	2,269	2,335	2,398	2,464	2,166	2,244	2,491	2,596	2,835
Bar Stool, Upholstered Back and Knit Seat, High Back, Arm 	F	2	8	3	H	24W x 26D x 49.25 - 57.25H	1	15	1,994	2,071	2,112	2,153	2,196	2,239	2,284	2,330	2,384	2,452	2,538	2,622	2,704	2,787	2,315	2,390	2,641	2,744	2,983
Bar Stool, Upholstered Back and Knit Seat, High Back, Armless 	F	1	8	3	H	19.5W x 26D x 49.25 - 57.25H	1	15	1,967	2,044	2,084	2,125	2,168	2,211	2,256	2,302	2,357	2,425	2,511	2,595	2,677	2,759	2,288	2,363	2,614	2,715	2,955

To Order Select Below



1. Series/Arm/Back/Style

	
F263H	F4 Bar Stool, Upholstered Back and Knit Seat Medium Back, Arm
F163H	F4 Bar Stool, Upholstered Back and Knit Seat Medium Back, Armless
F283H	F4 Bar Stool, Upholstered Back and Knit Seat High Back, Arm
F183H	F4 Bar Stool, Upholstered Back and Knit Seat High Back, Armless

2. Casters

	Hard Casters
BC	HARD, BLACK
GC	HARD, GRAY +29
CC	HARD, CHROME TRIM +102
	Soft Casters
BS	SOFT, BLACK +44
GS	SOFT, GRAY +55
CS	SOFT, CHROME TRIM +128

3. Arm Cap

	Polyurethane
A1	BLACK
A2	GRAY
	Wood
81	WHITE OAK +234
85	WALNUT +234
	Aluminum
70	ALUMINUM +85

Aluminum arm caps match the chosen frame finish



4. Base Frame Finish

	Standard Powder Coated Metal +105
BL	BLUE
BM	BLACK MATTE
CP	CHAMPAGNE
DB	DARK BRONZE
DG	DARK GRAY
DP	DUSTY PINK
DS	DARK SAGE
LG	LIGHT GRAY
LL	LILAC GRAY
LP	LIGHT PISTACHIO
LR	LIPSTICK RED
MB	MIDNIGHT BLUE
	Polished Metal
AL	POLISHED ALUMINUM



5. Trim Color

	Trim Color
	CHROME CYLINDER, BLACK CAP, BUTTON
T01	
T11	ALL BLACK
T22	ALL GRAY
	WHITE CYLINDER, BLACK CAP, BUTTON
T31	
	WHITE CYLINDER, GRAY CAP, BUTTON
T32	

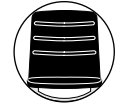
6. Options





	Options
HL	HEIGHT LOCK
	CONTRASTING THREAD
CT	
	Decorative Upholstery
D1	CHANNEL +146
D2	LOOP +146
	Channel
	Loop

7. Back/Seat Choice

	Knit Seat Color
K01	BLACK
K02	GRAPHITE
K03	SMOKE
K13	POPPY
K15	MIDNIGHT BLUE
K22	BLACK/SMOKE
K23	BLACK/BRONZE
K26	BLACK/MIDNIGHT BLUE
K27	BLACK/RED
	Upholstery
	See general information section for details on textile program and COM/COL information.

F4

BAR STOOL: FULLY UPHOLSTERED

TITLE	SERIES	ARM	BACK	UPH	HEIGHT	DIMENSIONS	YDG	SQFT	Textile Upholstery Grades												Leather Upholstery Grades						
									COM	COL	COM	A	B	COL	C	D	E	F	G	H	I	J	K	L	M	W	X
 Bar Stool, Fully Upholstered, Medium Back, Arm	F	2	6	4	H	24W x 26D x 44.75 - 54.75H	1.6	20	1,875	1,994	2,059	2,123	2,187	2,253	2,324	2,394	2,479	2,591	2,721	2,851	2,976	3,108	2,423	2,562	3,005	3,188	3,646
 Bar Stool, Fully Upholstered, Medium Back, Armless	F	1	6	4	H	19.5W x 26D x 44.75 - 54.75H	1.6	20	1,848	1,967	2,032	2,096	2,160	2,226	2,297	2,366	2,451	2,563	2,693	2,823	2,949	3,080	2,396	2,534	2,976	3,161	3,619
 Bar Stool, Fully Upholstered, High Back, Arm	F	2	8	4	H	24W x 26D x 49.25 - 57.25H	1.8	23	1,994	2,131	2,205	2,278	2,350	2,425	2,507	2,592	2,686	2,812	2,960	3,108	3,255	3,403	2,547	2,683	3,125	3,310	3,768
 Bar Stool, Fully Upholstered, High Back, Armless	F	1	8	4	H	19.5W x 26D x 49.25 - 57.25H	1.8	23	1,967	2,103	2,178	2,251	2,322	2,398	2,480	2,564	2,659	2,785	2,932	3,080	3,228	3,376	2,519	2,656	3,098	3,282	3,740

To Order Select Below

1. Series/Arm/Back/Style

- F264H**
F4 Bar Stool, Fully Upholstered Medium Back, Arm
- F164H**
F4 Bar Stool, Fully Upholstered Medium Back, Armless
- F284H**
F4 Bar Stool, Fully Upholstered High Back, Arm
- F184H**
F4 Bar Stool, Fully Upholstered High Back, Armless

2. Casters

- Hard Casters**
 - BC HARD, BLACK
 - GC HARD, GRAY **+29**
 - CC HARD, CHROME TRIM **+102**
- Soft Casters**
 - BS SOFT, BLACK **+44**
 - GS SOFT, GRAY **+55**
 - CS SOFT, CHROME TRIM **+128**

3. Arm Cap

- Polyurethane**
 - A1 BLACK
 - A2 GRAY
 - Wood**
 - 81 WHITE OAK **+234**
 - 85 WALNUT **+234**
 - Aluminum**
 - 70 ALUMINUM **+85**
- Aluminum arm caps match the chosen frame finish



4. Base Frame Finish

- Standard Powder Coated Metal** **+105**
 - BL BLUE
 - BM BLACK MATTE
 - CP CHAMPAGNE
 - DB DARK BRONZE
 - DG DARK GRAY
 - DP DUSTY PINK
 - DS DARK SAGE
 - LG LIGHT GRAY
 - LL LILAC GRAY
 - LP LIGHT PISTACHIO
 - LR LIPSTICK RED
 - MB MIDNIGHT BLUE
 - MG MEADOW GREEN
 - MK MILK
 - MS METALLIC SILVER
 - NK NICKEL
 - OC OCHRE
 - PY PALE YELLOW
 - RO RED ORANGE
 - RR RUSTY RED
 - SB SOFT BLUE
 - SD SAND
 - TC TERRACOTTA
 - TP TAUPE
- Polished Metal**
 - AL POLISHED ALUMINUM

5. Trim Color

- Trim Color**
 - T01 CHROME CYLINDER, BLACK CAP, BUTTON
 - T11 ALL BLACK
 - T22 ALL GRAY
 - T31 WHITE CYLINDER, BLACK CAP, BUTTON
 - T32 WHITE CYLINDER, GRAY CAP, BUTTON

6. Options

- Options**
 - HL HEIGHT LOCK
 - CT CONTRASTING THREAD
 - Decorative Upholstery**
 - D1 CHANNEL **+146**
 - D2 LOOP **+146**
-  Channel
  Loop

7. Back/Seat Choice

- Upholstery**
See general information section for details on textile program and COM/COL information.

When pricing models with more than one fabric, the higher grade fabric will determine the overall grade of the specific product.