

**stylex**

# Ridge

PRICE LIST

Effective November 01, 2024

# General Information

## STYLEX PRICE LIST

### GENERAL INFORMATION

#### Terms

Net 30 days from date of invoice,  
F. O. B . Delanco, New Jersey.

#### Damaged Shipments

All Stylex products are carefully inspected before they are packed in sturdy cartons designed to satisfy shipping requirements. Stylex is not responsible for damage in shipment. The transportation company assumes responsibility for delivering products to you in good condition when the bill of lading is signed. You protect yourself by refusing shipments showing damage or shortage until transportation company has noted on the delivery sheet the extent of damage or shortage. Concealed damage should be reported to the carrier as soon as discovered, but no later than 5 days after receiving shipment.

#### Return/Restocking Policy

Return shipments will not be accepted unless specifically authorized by Stylex in writing. The Return Authorization number should be clearly marked on the carton. The customer returning Stylex products is responsible for return shipping costs. Merchandise must be returned unused. Returned merchandise is subject to a 35% restocking fee.

#### Special Products

Modifications to standard products will be considered for large runs. Contact factory for price quotations.

#### Design Changes

In keeping with modern manufacturing advances, Stylex reserves the right to incorporate minor modifications and design changes in products without notice.

#### Cancellation/Change Order Policy

Regarding requests for order cancellation and/or order modification, please be advised that no charges will be applied before production, unless inventory has been specifically requisitioned to fulfill your order. Once orders proceed to the production phase, they cannot be altered or canceled under any circumstances. All requests for order cancellations or order changes must be submitted in writing and will only be considered valid upon approval by Stylex.

### WARRANTY

Except as provided below, Stylex warrants exclusively to the original Purchaser of our product that all parts, under normal use and service, will be free from defects in workmanship and material for a period of ten (10) years from the date of purchase. "Normal use and service" means that the product will be used in a typical office environment for 40-45 hours per week.

This warranty is subject to the following limitations, exclusions and provisions:

Limitations involving materials and components:

**Wood components of plywood stacking chairs**  
(such as Brooks and Welcome)  
5 years

#### Upholstery

(including mesh used for Click, F4, Insight, and Zephyr Mesh)  
3 years

#### SAVA Mesh

10 years

#### Pneumatic Cylinders

3 years

#### COM Upholstery

No warranty  
Stylex makes every effort to ensure that the COM Upholstery it approves is suitable for the intended use. Nevertheless, we will not warrant, and assume no responsibility for, the durability or tailoring quality of any COM or COL . If you have any concerns about the ultimate appearance of any covering, please order an upholstered sample.

#### Painted Stack Chair Frames

No Warranty  
We will not warrant the finish of painted stack chair frames against damage from stacking. Please order chrome frames for chairs that will be stacked.

#### Felt Glides

No warranty  
Due to the different surfaces on which felt glides may be used, we cannot warrant their durability over time.

If this product fails during normal use and service within the applicable warranty period (other than through normal wear and tear), please submit a warranty claim at [stylexdesign.com/warranty-claim/](http://stylexdesign.com/warranty-claim/). Quantity, model details, description of issue, and Stylex certified labels are required for submission. PLEASE DO NOT RETURN PARTS OR THE PRODUCT TO STYLEX UNLESS INSTRUCTED TO DO SO BY STYLEX. Stylex will, at its discretion, either repair or replace the defective product or part at no cost. Labor requests must receive approval and will be authorized on a case-by-case basis. We will only reimburse for labor costs directly incurred, excluding any travel-related expenses. Purchaser may be required (at the option of Stylex) to return to Stylex at Purchaser's expense any defective part with all freight or shipping charges prepaid. The foregoing warranty shall be void if the product has been altered or repaired (other than by Stylex). The warranty does not cover damage to the product caused by accident, neglect, misuse, abuse, modification to the product by anyone other than Stylex or damage caused by use of the product for a purpose other than that for which it was designed. This warranty extends only to the original Purchaser of the product.

#### No Other Warranties

This warranty is in lieu of all other warranties, expressed or implied, including, but not limited to, implied warranties of merchantability and fitness for a particular purpose. The rights and remedies provided herein are the exclusive rights and remedies of the original purchaser of the product.

#### No Liability For Damages

In no event shall Stylex or its suppliers be responsible or liable for any special, indirect, consequential, or incidental damages. In no event shall the liability of Stylex exceed the actual purchase price paid to Stylex for the product.

#### Out of Warranty Products

For all products no longer covered by our warranty, please refer to our Design for Durability and Upgradability Policy. Contact your Account Manager if you would like to purchase any replaceable components to further extend the life of any Stylex seating product. This warranty applies to all Stylex products purchased on April 13, 2018, and thereafter.

### PRODUCT TAKE BACK PROGRAM

In order to be good stewards of our products, Stylex offers a pathway towards a Product Take Back Program as a more viable solution to the end of our products' originally intended life.

Stylex supports the sustainable programs of ANEW and offers their added value to our clients through a comprehensive take-back solution for surplus office furniture and materials of any kind, in any condition. ANEW is a 501(c)(3) non-profit organization that exists to provide companies with smart, cost effective alternatives for their surplus furniture and other items with the priority of matching it to non- profits, public agencies and the underserved, within the local community of the project site. Corporate Social Responsibility is raised while the impact on the environment is lowered by diverting products and materials otherwise destined for landfill.

Stylex is proud to offer ANEW to customers dedicated to strengthening their community network by repurposing their furniture, fixtures and architectural materials to those in need. In 2014, Stylex committed to making this relationship a part of our strategic sales strategy. Visit [www.anewfound.org](http://www.anewfound.org) to find out more.

To initiate a Product Take Back strategy through ANEW, contact Stylex Account Management at 800-257-5742.

For other end of life recovery options, please see our Product Disassembly Instructions and End of Life Recovery Options documents available on our website in the resources section of each product in our line.

### FREIGHT PROGRAM

Freight charges will be calculated as a percentage of the net product price and added to the invoice at the time of shipment. The continental United States has been divided into three zones. Please use the map below to determine freight charges for the product's destination. Minimum freight charge is \$250. Please let us know if you will be shipping to a residential address or require inside delivery as this requires an additional fee. Also please note we need to be made aware if a liftgate is required prior to delivery. If any requests are made at the time of delivery, applicable charges will apply.

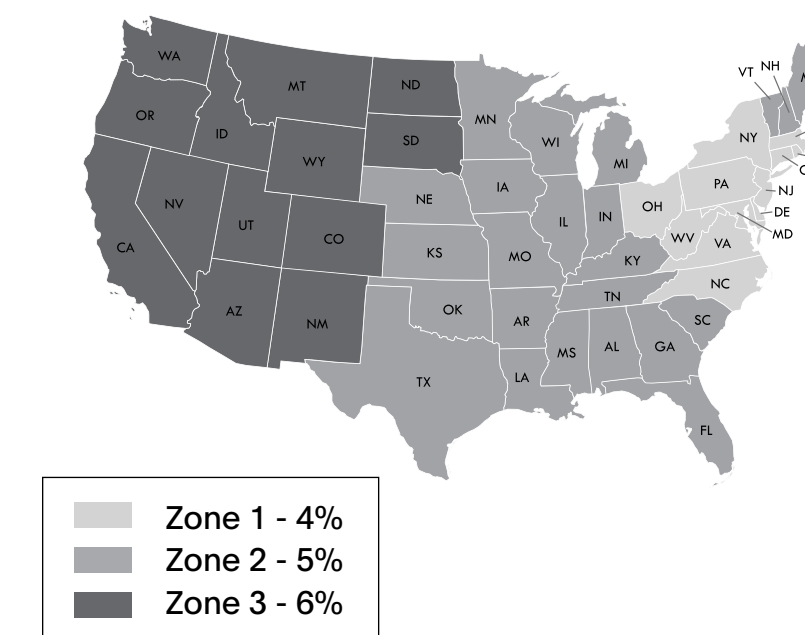

### ZONE 1 - 4%

Connecticut  
Delaware  
New York  
New Jersey  
Maryland  
Massachusetts  
North Carolina  
Ohio  
Pennsylvania  
Rhode Island  
Virginia  
Washington D.C.  
West Virginia

### ZONE 2 - 5%

Alabama  
Arkansas  
Canada, Ontario  
Canada, Quebec  
Florida  
Georgia  
Iowa  
Illinois  
Indiana  
Kansas  
Kentucky  
Louisiana  
Nebraska  
New Hampshire  
Oklahoma  
Maine  
Michigan  
Minnesota  
Missouri  
Mississippi  
South Carolina  
Tennessee  
Texas  
Vermont  
Wisconsin

### ZONE 3 - 6%

Arizona  
California  
Colorado  
Idaho  
Montana  
Nevada  
New Mexico  
North Dakota  
Oregon  
South Dakota  
Utah  
Washington  
Wyoming

**Quote Per Project**  
Alaska  
Hawaii  
Canada  
(outside Ontario & Quebec)  
Mexico

# General Information

## STYLEX PRICE LIST

### TEXTILE PARTNERS & APPROVALS

#### Textile Partners

To customize your furniture performance needs and design vision, Stylex offers a wide selection of in-graded leathers and textiles from Grades A through Y. We've partnered with leading manufacturers on the options, focusing on color, price, durability, and construction. To view our partners and explore our digital carded program with broadly approved textiles, visit [this page](#). We stand by these textiles: They're tried and tested, and will effortlessly fit into any design aesthetic.

#### Textile Approvals

All textiles must be approved for the product you are specifying. For the related approved textile lists, visit [this page](#).

### CAL 117 AND 133 COMPLIANCE

#### CAL 117-2013

CAL 117-2013 compliance is a requirement for all textiles applied on our seating products. All Stylex seating products meet this standard.

#### CAL 133

Most Stylex seating can be ordered to meet the requirements of CAL 133. When ordering, simply specify "CAL 133 compliance required". The upcharge for this option is \$54 list per yard. Please refer to the COM yardage of each model to determine the number of yards required. We do frequently require full-scale burn tests in order to certify CAL 133 before an order will be accepted. Such burn tests may increase normal lead times and do carry additional charges. Please contact your Stylex account manager for details.

### CUSTOMER'S OWN MATERIAL/LEATHER

Customer's own material (COM) and customer's own leather (COL) will generally be upholstered at the price designated in each product's price list. Please be advised, however, that we specifically reserve the right to charge a higher price when we determine that special circumstances, such as unusual repeats or challenging materials, present themselves. All orders for custom coverings must be approved by Stylex before they will be accepted for production. To submit proposed textile for approval, please use the COM form [here](#).

#### Special Note:

We assume no responsibility for the durability or tailoring quality of any COM or COL. Directional covers in particular may not meet your satisfaction due to the design of certain products. Please be advised that COM and COL orders are not subject to return. If you have doubts about the ultimate appearance of certain coverings, please order a sample done with that specific COM or COL. In addition, while we inspect fabrics for mill imperfections, some are difficult to recognize. We cannot be responsible for defects, color inaccuracies, dye lot variations, or other flaws.

Under no circumstances will we be responsible for COM shortages, flaws, or other such problems. Finally, it is not our responsibility to police the receipt of COM's in order to meet delivery deadlines, and we assume our customers are aware of any undue delay in the shipment of their COM fabrics.

#### COM fabric and COL leather should be sent prepaid to: Stylex

**Attn: COM/COL - [Your Stylex PO #]  
740 Coopertown Road  
Delanco, NJ 08075**

**All COM/COL sent to Stylex must be accompanied with a packing list which indicates the dealers' name, Stylex corresponding PO number, sales order number, COM/COL supplier name, textile pattern, colorway and shipped quantity. Stylex requires COM to be sent in as continuous yardage in the same dielot.**

Yardage requirements shown in the price list are based on non-directional goods of 54" width. Fabrics less than 54" wide or those requiring matching (stripes, prints, or large patterned designs) call for additional yardage. We will be happy to supply yardage requirements for large quantities where economies may be realized.

#### Add the following yardage for stripes, plaids, or patterns with repeats:

| Fabric Width | Plain Fabric | 2-14" Repeat | 15-24" Repeat | 25-27" Repeat | 28-36" Repeat |
|--------------|--------------|--------------|---------------|---------------|---------------|
| 54"          | 0%           | 10%          | 15%           | 20%           | 25%           |
| 50"          | 10%          | 20%          | 25%           | 30%           | 35%           |
| 48"          | 15%          | 25%          | 30%           | 35%           | 40%           |
| 45"          | 40%          | 50%          | 55%           | 60%           | 65%           |
| 36"          | 50%          | 60%          | 65%           | 70%           | 75%           |

### COM/COL FORM

To avoid delay in processing COM orders we request that you submit a sample of your COM textile stapled to this form which can be downloaded [here](#). If a textile has a stripe or design, the size of the repeat should be indicated. Please indicate the textile supplier's name, textile number, and color. Also indicate the Stylex product on which the textile will be used. If a certain direction of application is required, please ensure that information is communicated directly to your Stylex account manager.

The fabric supplier must indicate on his shipping labels the dealer name and purchase order number as well as the Stylex model number.

#### Please Note:

No order may be entered into production or have a shipping date assigned until all related COM is received at the factory.



### CENTER OF STRIPE OR DESIGN

|              |              |
|--------------|--------------|
| TOP OF CHAIR | TOP OF CHAIR |
|--------------|--------------|

1. Size of Repeat

2. Textile Supplier

3. Textile Number

4. Color

5. Stylex Product

# Ridge

## SPECIFICATION GUIDE: OVERVIEW AND DIMENSIONS

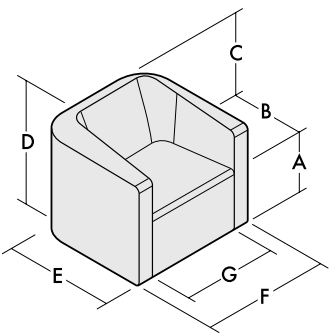
| OVERVIEW   |   |   |   |  |
|--|---|---|---|--|
| <b>Dimensions</b><br>A. Seat Height<br>B. Seat Depth<br>C. Back Height<br>D. Overall Height<br>E. Overall Depth<br>F. Overall Width<br>G. Seat Width |  | <b>Single Seat</b><br>A. 17.3<br>B. 20<br>C. 12.5<br>D. 30<br>E. 31.5<br>F. 32<br>G. 23.5     | <b>Single Seat w/Casters</b><br>A. 18<br>B. 20<br>C. 12.5<br>D. 30.5<br>E. 31.5<br>F. 32<br>G. 23.5 |  |
|  |   | <b>Loveseat</b><br>A. 17.5<br>B. 20<br>C. 12.5<br>D. 30<br>E. 31.5<br>F. 56<br>G. 47.5        | <b>Two Seat Sofa</b><br>A. 17.5<br>B. 20<br>C. 12.5<br>D. 30<br>E. 31.5<br>F. 66<br>G. 57.5         |  |
|  |   | <b>Three Seat Sofa</b><br>A. 17.5<br>B. 20<br>C. 12.5<br>D. 30<br>E. 31.5<br>F. 80<br>G. 71.5 |   |  |

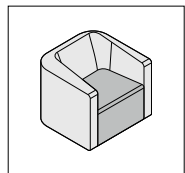
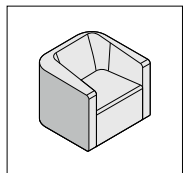
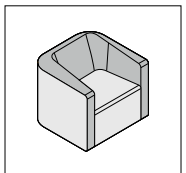
| DUAL UPHOLSTERY OPTIONS   |   |   |
|---|---|---|
| Second Textile on Seat<br> | Second Textile on Outside Back<br> | Second Textile on Seat, Outside Back<br> |

### RIDGE WELT CORD PROGRAM

The Ridge welt cord runs along both sides of the arms and around the back. It can be specified in a second color or to match the primary chair upholstery.

**Please Note:** Welt cords may not be specified with either the dual upholstery option or polyurethane textile.

#### WC1 Matching Textile Welt Cord +310

The welt cord will match the textile or leather used on the chair.

#### WC2 Contrasting Welt Cord +387

The welt cord is a second material. The purchase of additional material may be required.

**COM:** There is a two yard minimum for the contrasting textile welt cord material. Please contact your account manager for the specific yardage required.

#### Customer Supplied Welt Cords

Please contact your account manager if you wish to supply your own welt cords.

#### In-Graded Textile Program

There is a two yard minimum for the contrasting welt cord material when a non-stocked color is selected. Non-stocked, in-graded contrasting welt cord textile can be purchased by the yard. Please contact Stylex customer service for pricing. See In-Stock, Contrasting Welt Cord Program to simplify the selection of a contrasting welt cord.

#### In-Stock Contrasting Welt Cord Program

Stylex stocks a limited number of textile and leather welt cords. This program may help reduce the cost and the work required to specify this option. Here is the current list:

| Maharam Manner +387 | Kvadrat Divina +387 |
|---------------------|---------------------|
| 001 Magic           | 191                 |
| 009 Pathway         | 793                 |
| 008 Cocoa           | 173                 |
| 004 Flint           | 106                 |
| 005 Hush            | 356                 |
| 027 Schooner        | 393                 |

The advantage of using a contrasting welt cord from our in-stock program is that you incur no additional charge for the material required. If, for example, you were to specify an in-graded textile for a contrasting welt cord, you would be required to purchase at least two yards of textile in addition to paying the \$387 (textile)fee. With the in-stock welt cord program, you only pay the \$387 (textile) fee and need not purchase any additional textile.

### PRODUCT INFORMATION

**Design**  
Aodh O Donnell

**Upholstery**  
Textiles for Ridge Lounge must be cut up the roll.

**Glides**  
Ridge is available with 3 glide options: plastic, rubber and felt.

**Use**  
Designed for indoor use only.

**Testing**  
Manufactured to comply with ANSI/ BIFMA X5.4 Lounge Seating tests.

**Certifications**  
GREENGUARD LEVEL® 2

# Ridge

SPECIFICATION GUIDE: HOW TO ORDER

---

## MODEL CODE BREAKDOWN

---

Sample Model Code: RE110CAWC1DF1COM

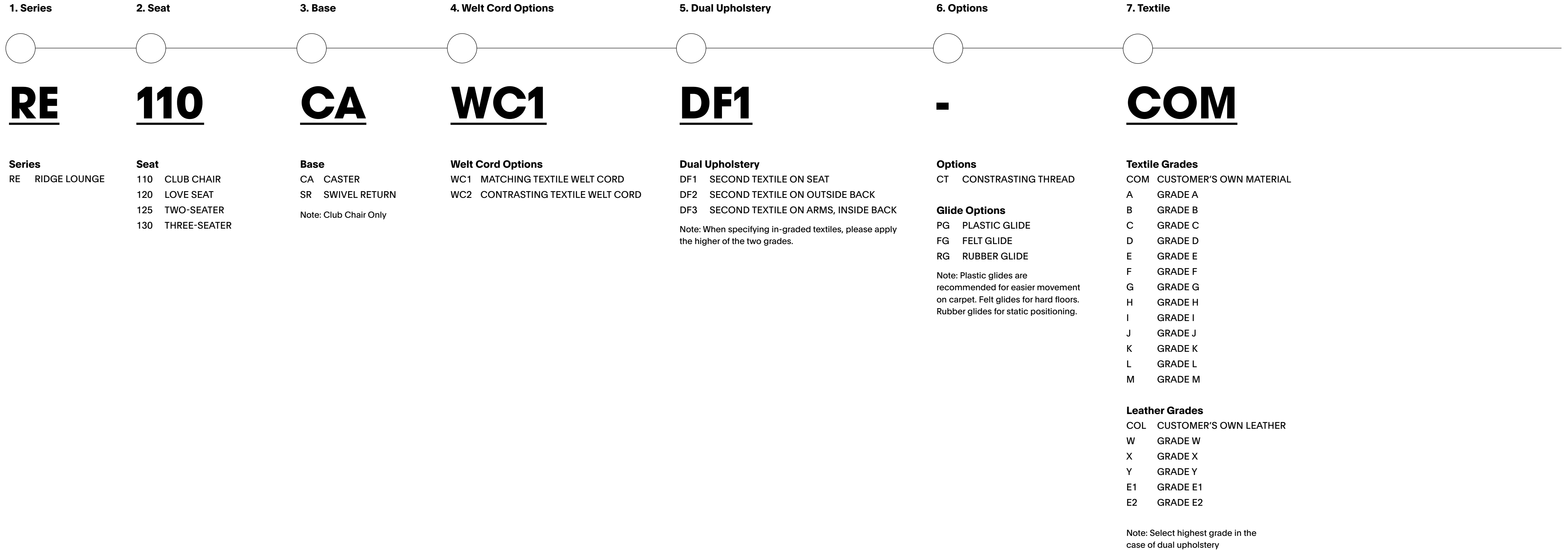



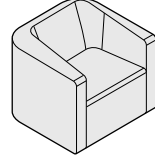
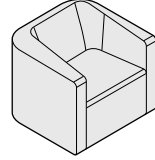
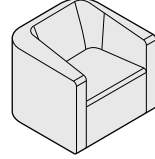

# Ridge

CLUB CHAIR



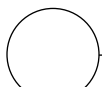
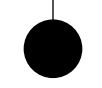

| TITLE  | SERIES | SEAT | BASE | DIMENSIONS           | YDG | Textile Upholstery Grades |       |       |       |       |       |       |       |       |       |       |       |       |       |
|--|--------|------|------|----------------------|-----|---------------------------|-------|-------|-------|-------|-------|-------|-------|-------|-------|-------|-------|-------|-------|
|  |        |      |      |                      |     | COM                       | COL   |       |       |       |       |       |       |       |       |       |       |       |       |
|  |        |      |      |                      |     | COM                       | A     | B     | C     | D     | E     | F     | G     | H     | I     | J     | K     | L     | M     |
| <b>Single Seat</b><br>                    | RE     | 110  | -    | 32W x 31.5D x 30H    | 4.6 | 3,712                     | 4,117 | 4,338 | 4,552 | 4,773 | 4,994 | 5,235 | 5,478 | 5,762 | 6,132 | 6,573 | 7,013 | 7,446 | 7,831 |
| <b>Single Seat with Casters</b><br>       | RE     | 110  | CA   | 32W x 31.5D x 30.5H  | 4.6 | 3,712                     | 4,117 | 4,338 | 4,552 | 4,773 | 4,994 | 5,235 | 5,478 | 5,762 | 6,132 | 6,573 | 7,013 | 7,446 | 7,831 |
| <b>Single Seat with Swivel Return</b><br> | RE     | 110  | SR   | 32W x 31.5D x 30.25H | 4.6 | 4,176                     | 4,582 | 4,803 | 5,017 | 5,236 | 5,458 | 5,697 | 5,940 | 6,225 | 6,595 | 7,036 | 7,476 | 7,912 | 8,294 |

To Order Select Below

1. Series/Seat/Base

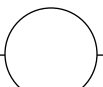
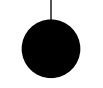
-    
RE110  
**Ridge Club Chair**
-   
RE110CA  
**Ridge Club Chair with Casters**
-   
RE110SR  
**Ridge Club Chair with Swivel Return**

2. Welt Cord Options

-    
**Welt Cord Options**  
The Ridge welt cord runs along both sides of the arms and around the back. It can be specified in a second color or to match the chair upholstery. The welt cord option is not available with the dual fabric option or any polyurethane fabric.
-   
Please see [page 4](#) for a complete explanation of the Ridge Welt Cord Program.
-   
**Matching Welt Cord**  
WC1 MATCHING TEXTILE WELT CORD **+310**  
The welt cord will match textile used on chair.
-   
**Contrasting Welt Cord**  
WC1 CONTRASTING TEXTILE WELT CORD **+387**  
The welt cord will match textile used on chair.

3. Dual Upholstery

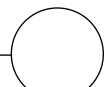
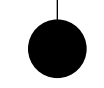
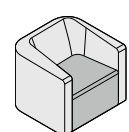
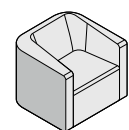
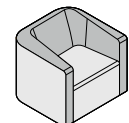
-    
**Dual Upholstery**  
The Dual Upholstery options allow for two fabrics in three different combinations. When specifying In-Graded textiles, please apply the higher of the two grades.
  - DF1 SECOND TEXTILE ON SEAT
  - DF2 SECOND TEXTILE ON OUTSIDE BACK
  - DF3 SECOND TEXTILE ON ARMS, INSIDE BACK
- |   |            |   |                                    |
|---|------------|---|------------------------------------|
|  | <b>DF1</b> | <b>Second Textile on Seat</b><br>Seat<br>Arms, Inside Back, Outside Back              | <b>RE110</b><br>1.2 yds<br>3.5 yds |
|  | <b>DF2</b> | <b>Second Textile Outside Back</b><br>Seat, Inside Back, Arms<br>Outside Back         | <b>RE110</b><br>3.0 yds<br>1.7 yds |
|  | <b>DF3</b> | <b>Second Textile on Arms, Inside Back</b><br>Seat, Outside Back<br>Arms, Inside Back | <b>RE110</b><br>2.8 yds<br>1.9 yds |

4. Options

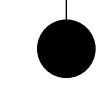
-    
**Options**  
CT CONTRASTING THREAD  
Not available with the welt cord options.
-   
**Glide Options**  
PG PLASTIC GLIDE  
FG FELT GLIDE  
RG RUBBER GLIDE  
Plastic glides are recommended for easier movement on carpet. Felt glides for hard floors. Rubber glides for static positioning.

5. Upholstery

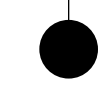
-    
**See general information section for details on textile program and COM/COL information.**  
Textiles for Ridge must be cut up the roll.  
When pricing models with more than one textile, the higher grade textile will determine the overall grade of the specific product.

# Ridge

SOFA

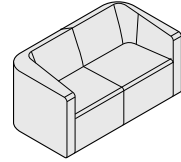
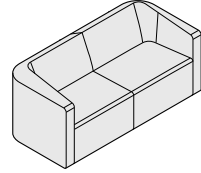
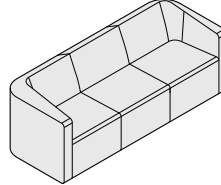
| TITLE   | SERIES | SEAT | BASE | DIMENSIONS        | YDG | Textile Upholstery Grades |       |       |       |       |       |       |        |        |        |        |        |        |        |
|---|--------|------|------|-------------------|-----|---------------------------|-------|-------|-------|-------|-------|-------|--------|--------|--------|--------|--------|--------|--------|
|   |        |      |      |                   |     | COM                       | COL   |       |       |       |       |       |        |        |        |        |        |        |        |
|   |        |      |      |                   |     | COM                       | A     | B     | C     | D     | E     | F     | G      | H      | I      | J      | K      | L      | M      |
| <b> Loveseat </b><br>        | RE     | 120  | -    | 56W x 31.5D x 30H | 8   | 5,258                     | 5,964 | 6,349 | 6,719 | 7,101 | 7,486 | 7,908 | 8,327  | 8,821  | 9,464  | 10,235 | 11,001 | 11,754 | 12,422 |
| <b> Two-Seat Sofa </b><br>   | RE     | 125  | -    | 66W x 31.5D x 30H | 9.5 | 5,877                     | 6,717 | 7,170 | 7,612 | 8,066 | 8,522 | 9,023 | 9,521  | 10,109 | 10,874 | 11,784 | 12,694 | 13,592 | 14,383 |
| <b> Three-Seat Sofa </b><br> | RE     | 130  | -    | 80W x 31.5D x 30H | 9.8 | 6,498                     | 7,360 | 7,830 | 8,284 | 8,756 | 9,225 | 9,741 | 10,254 | 10,861 | 11,649 | 12,588 | 13,530 | 14,454 | 15,271 |

**To Order Select Below**

**1. Series/Seat/Base**

- RE120  
**Ridge Loveseat**
- RE125  
**Ridge Two-Seat Sofa**
- RE130  
**Ridge Three-Seat Sofa**

**2. Welt Cord Options**

- Welt Cord Options**  
The Ridge welt cord runs along both sides of the arms and around the back. It can be specified in a second color or to match the chair upholstery. The welt cord option is not available with the dual fabric option or any polyurethane fabric.
- Matching Welt Cord**  
Please see [page 4](#) for a complete explanation of the Ridge Welt Cord Program.  
WC1 MATCHING TEXTILE WELT CORD **+310**  
The welt cord will match textile used on chair.
- Contrasting Welt Cord**  
WC1 CONTRASTING TEXTILE WELT CORD **+387**  
The welt cord will match textile used on chair.

**3. Dual Upholstery**

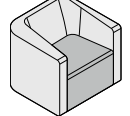
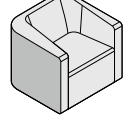
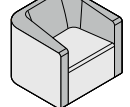
- Dual Upholstery**  
The Dual Upholstery options allow for two fabrics in three different combinations. When specifying In-Graded textiles, please apply the higher of the two grades.
  - DF1 SECOND TEXTILE ON SEAT
  - DF2 SECOND TEXTILE ON OUTSIDE BACK
  - DF3 SECOND TEXTILE ON ARMS, INSIDE BACK
- |   |            |   |                                    |                                    |                                    |
|---|------------|---|------------------------------------|------------------------------------|------------------------------------|
|  | <b>DF1</b> | <b>Second Textile on Seat</b><br>Seat<br>Arms, Inside Back, Outside Back              | <b>RE120</b><br>3.0 yds<br>5.0 yds | <b>RE125</b><br>3.7 yds<br>5.8 yds | <b>RE130</b><br>3.7 yds<br>6.1 yds |
|  | <b>DF2</b> | <b>Second Textile Outside Back</b><br>Seat, Inside Back, Arms<br>Outside Back         | <b>RE120</b><br>5.5 yds<br>2.5 yds | <b>RE125</b><br>6.9 yds<br>2.6 yds | <b>RE130</b><br>7.2 yds<br>2.6 yds |
|  | <b>DF3</b> | <b>Second Textile on Arms, Inside Back</b><br>Seat, Outside Back<br>Arms, Inside Back | <b>RE120</b><br>5.4 yds<br>2.6 yds | <b>RE125</b><br>6.1 yds<br>3.4 yds | <b>RE130</b><br>6.1 yds<br>3.7 yds |

**4. Options**

- Options**  
CT CONTRASTING THREAD  
Not available with the welt cord options.
- Glide Options**  
PG PLASTIC GLIDE  
FG FELT GLIDE  
RG RUBBER GLIDE  
Plastic glides are recommended for easier movement on carpet. Felt glides for hard floors. Rubber glides for static positioning.

**5. Upholstery**

- See general information section for details on textile program and COM/COL information.**  
Textiles for Ridge must be cut up the roll.  
When pricing models with more than one textile, the higher grade textile will determine the overall grade of the specific product.