

stylex

State of Georgia

TERM & CONTRACT NUMBER

April 08, 2024 - November 30, 2025

99999-001-SPD0000198-0063

PRICE LIST INFORMATION

List Pricing Effective November 01, 2023

Please apply appropriate discounting
structure listed below.

Delivered & Installed: 40% off list

Inside Delivery: 41% off list

Dock Delivery: 42% off list

State of Georgia

Contents

BROOKS	3	INSIGHT	159	RIDGE GUEST	327
CLICK	17	INSIGHT EXECUTIVE	182	SAVA	333
COVE LOUNGE	25	INSIGHT MESH	191	SHARE	357
DAU	38	LUNA	197	UNDERLINE	412
DELA	56	MARK 2	235	VERVE	424
EASE UP	71	METRUM	244	WELCOME	454
F4	76	NESTLE	262	ZEPHYR	466
FREE ADDRESS	93	NYC	272		

stylex

Brooks

PRICE LIST

Effective November 01, 2023

General Information

GENERAL INFORMATION

Terms

Net 30 days from date of invoice.
FOB Delanco, NJ

Damaged Shipments

All Stylex products are carefully inspected before they are packed in sturdy cartons designed to satisfy shipping requirements. Stylex is not responsible for damage in shipment. The transportation company assumes responsibility for delivering products to you in good condition when the bill of lading is signed. You protect yourself by refusing shipments showing damage or shortage until transportation company has noted on the delivery sheet the extent of damage or shortage. Concealed damage should be reported to the carrier as soon as discovered, but not later than 15 days after receiving shipment.

Return/Restocking Policy

Return shipments will not be accepted unless specifically authorized by Stylex in writing. The Return Authorization number should be clearly marked on the carton. The customer returning Stylex products is responsible for return shipping costs. Merchandise must be returned unused. Returned merchandise is subject to a 35% restocking fee.

Specials/Customs

Modifications to standard products will be considered for large runs. Contact Stylex for more information.

Design Changes

In keeping with modern manufacturing advances, Stylex reserves the right to incorporate minor modifications and design changes in products without notice.

Cancellation Policy

No charge prior to production except for inventory specifically requisitioned to fulfill the particular order. After production has begun, only actual costs incurred, including labor and material, will be billed to the customer.

WARRANTY

Except as provided below, Stylex warrants exclusively to the original Purchaser of our product that all parts, under normal use and service, will be free from defects in workmanship and material for a period of ten (10) years from the date of purchase. "Normal use and service" means that the product will be used in a typical office environment for 40-45 hours per week.

This warranty is subject to the following limitations, exclusions and provisions:

Wood components of plywood stacking chairs
(such as Brooks and Welcome)
5 years

Upholstery
(including mesh used for Click, F4, Insight, and Zephyr Mesh)
3 years

SAVA Mesh
10 years

COM Upholstery
No warranty
Stylex makes every effort to ensure that the COM Upholstery it approves is suitable for the intended use. Nevertheless, we will not warrant, and assume no responsibility for, the durability or tailoring quality of any COM or COL. If you have any concerns about the ultimate appearance of any covering, please order an upholstered sample.

Painted Stack Chair Frames
No Warranty
We will not warrant the finish of painted stack chair frames against damage from stacking. We recommend ordering chrome frames for chairs that will be stacked.

Felt Glides
No warranty
Due to the different surfaces on which felt glides may be used, we cannot warrant their durability over time.

If this product fails during normal use and service within the applicable warranty period (other than through normal wear and tear), please send a description of the relevant part and the nature of the defect, together with proof of purchase of the product, to Stylex at: Customer Service. c/o Stylex, P.O. Box 5038, Delanco, NJ 08075. PLEASE DO NOT RETURN PARTS OR THE PRODUCT TO STYLEX UNLESS INSTRUCTED TO DO SO BY STYLEX. Stylex will, at its option, either repair or replace the product or the part found defective by Stylex completely without charge for materials or labor. Purchaser may be required (at the option of Stylex) to return to Stylex at Purchaser's expense any defective part with all freight or shipping charges prepaid. The foregoing warranty shall be void if the product has been altered or repaired (other than by Stylex). The warranty does not cover damage to the product caused by accident, neglect, misuse, abuse, modification to the product by anyone other than Stylex or damage caused by use of the product for a purpose other than that for which it was designed. This warranty extends only to the original Purchaser of the product.

No Other Warranties

This warranty is in lieu of all other warranties, expressed or implied, including, but not limited to, implied warranties of merchantability and fitness for a particular purpose. The rights and remedies provided herein are the exclusive rights and remedies of the original purchaser of the product.

No Liability For Damages

In no event shall Stylex or its suppliers be responsible or liable for any special, indirect, consequential, or incidental damages. In no event shall the liability of Stylex exceed the actual purchase price paid to Stylex for the product.

Out of Warranty Products

For all products no longer covered by our warranty, please refer to our Design for Durability and Upgradability Policy. Contact Customer Service if you would like to purchase any replaceable components to further extend the life of any Stylex seating product. This warranty applies to all Stylex products purchased on April 13, 2018, and thereafter.

PRODUCT TAKE BACK PROGRAM

At Stylex, responsible stewardship of our products extends beyond their initial use. Our Product Take Back Program provides a practical solution for the end of our products' intended life cycle.

Through our partnership with ANEW, a 501(c)(3) nonprofit organization, we offer clients a comprehensive take-back solution for surplus office furniture and materials, regardless of their condition. ANEW's mission aligns with ours—to connect surplus resources with non-profits, public agencies, and underserved communities, minimizing landfill impact and maximizing corporate social responsibility.

By repurposing surplus items, we strengthen community networks and reduce environmental impact. Stylex proudly supports ANEW, integrating this partnership into our strategic sales strategy since 2014. Learn more at www.anewfound.org.

Initiate a Product Take Back through ANEW by emailing Stylex at info@stylexdesign.com. For additional end-of-life recovery options, refer to our Product Disassembly Instructions and End of Life Recovery Options documents, available in the Resources section of each product on our website. Together, let's build a sustainable future.

FREIGHT PROGRAM

Stylex offers a Guaranteed Freight Program, which provides the purchaser the ability to determine shipping and handling charges at the time of order. Freight charges will be calculated as a percentage of the net product price and added to the invoice at the time of shipment. The continental United States has been divided into three zones. Please use the map below to determine the freight charges for the product's destination. There is a minimum freight charge of \$150.

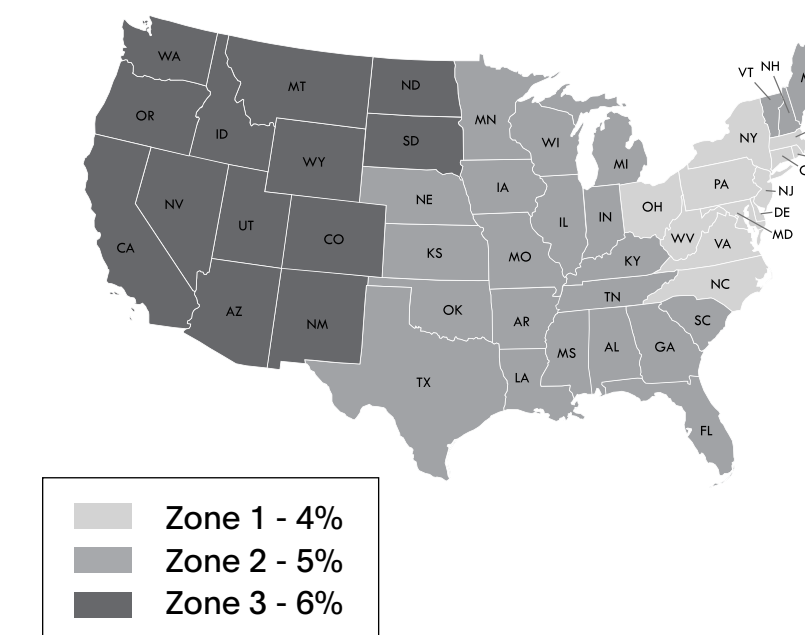

ZONE 1 - 4%

Connecticut
Delaware
New York
New Jersey
Maryland
Massachusetts
North Carolina
Ohio
Pennsylvania
Rhode Island
Virginia
Washington D.C.
West Virginia

ZONE 2 - 5%

Alabama
Arkansas
Canada, Ontario
Canada, Quebec
Florida
Georgia
Iowa
Illinois
Indiana
Kansas
Kentucky
Louisiana
Nebraska
New Hampshire
Oklahoma
Maine
Michigan
Minnesota
Mississippi
South Carolina
Tennessee
Texas
Vermont
Wisconsin

ZONE 3 - 6%

Arizona
California
Colorado
Idaho
Montana
Nevada
New Mexico
North Dakota
Oregon
South Dakota
Utah
Washington
Wyoming

Quote Per Project

Alaska
Hawaii
Canada
(outside Ontario & Quebec)
Mexico

General Information

TEXTILE PARTNERS & APPROVALS

Textile Partners

To customize your furniture performance needs and design vision, Stylex offers a wide selection of in-graded leathers and textiles from Grades A through Y. We've partnered with leading manufacturers on the options, focusing on color, price, durability, and construction. To view our partners and explore our digital carded program with broadly approved textiles, visit [this page](#). We stand by these textiles: They're tried and tested, and will effortlessly fit into any design aesthetic.

Textile Approvals

To view Stylex Approved Textile documents to determine specific product approval status, refer to our Product Tested Textiles documents, available in the Resources section of each product on our website.

CAL 117 AND 133 COMPLIANCE

CAL 117-2013

All Stylex seating satisfies the requirements of CAL 117-2013 so long as one of our standard or in-graded textiles is applied. COM textiles cannot be so guaranteed. Please contact the supplier of COM's directly to determine the fire retardancy of any COM supplied to us.

CAL 133

Most Stylex seating can be ordered to meet the requirements of CAL 133. When ordering, simply specify "CAL 133 compliance required". The upcharge for this option is \$54 list per yard. Please refer to the COM yardage of each model to determine the number of yards required. We do frequently require full-scale burn tests in order to certify CAL 133 before an order will be accepted. Such burn tests may increase normal lead times and do carry additional charges. Please contact customer service for details.

CUSTOMER'S OWN MATERIAL/LEATHER

Customer's own material (COM) and customer's own leather (COL) will generally be upholstered at the price designated in each product's price list. Please be advised, however, that we specifically reserve the right to charge a higher price when we determine that special circumstances, such as unusual repeats or challenging materials, present themselves. All orders for custom coverings must be approved by Stylex before they will be accepted for production. To submit proposed textile for approval, please use the COM form [here](#).

Special Note:

We assume no responsibility for the durability or tailoring quality of any COM or COL. Directional covers in particular may not meet your satisfaction due to the design of certain products. Please be advised that COM and COL orders are not subject to return. If you have doubts about the ultimate appearance of certain coverings, please order a sample done with that specific COM or COL. In addition, while we inspect textiles for mill imperfections, some are difficult to recognize. We cannot be responsible for defects, color inaccuracies, dye lot variations, or other flaws.

Under no circumstances will we be responsible for COM shortages, flaws, or other such problems. Finally, it is not our responsibility to police the receipt of COM's in order to meet delivery deadlines, and we assume our customers are aware of any undue delay in the shipment of their COM textiles.

COM textile and COL leather should be sent prepaid to: Stylex

**Attn: COM/COL - [Your PO #]
740 Coopertown Road
Delanco, NJ 08075**

Clearly mark textile or leather with the dealer's name, purchase order number, and furniture model number of the item to be covered. Actual furniture orders should include the same information, as well as a description of the textile or leather, including pattern and color number, in order to provide a cross reference.

Yardage requirements shown in the price list are based on non-directional goods of 54" width. Textiles less than 54" wide or those requiring matching (stripes, prints, or large patterned designs) call for additional yardage. We will be happy to supply yardage requirements for large quantities where economies may be realized.

Add the following yardage for stripes, plaids, or patterns with repeats:

Textile Width	Plain Textile	2-14" Repeat	15-24" Repeat	25-27" Repeat	28-36" Repeat
54"	0%	10%	15%	20%	25%
50"	10%	20%	25%	30%	35%
48"	15%	25%	30%	35%	40%
45"	40%	50%	55%	60%	65%
36"	50%	60%	65%	70%	75%

COM/COL FORM

To avoid delay in processing COM orders we request that you submit a sample of your COM textile stapled to this form which can be downloaded [here](#). If a textile has a stripe or design, the size of the repeat should be indicated. Please indicate the textile supplier's name, textile number, and color. Also indicate the Stylex product on which the textile will be used.

The textile supplier must indicate on his shipping labels the dealer name and purchase order number as well as the Stylex model number.

Please Note:

No order may be entered into production or have a shipping date assigned until all related COM is received at the factory.



CENTER OF STRIPE OR DESIGN

TOP	TOP
-----	-----

1. Size of Repeat

2. Textile Supplier

3. Textile Number

4. Color

5. Stylex Product

Brooks

Contents

COLORS, MATERIALS, AND FINISHES	5
OVERVIEW AND DIMENSIONS	6
HOW TO ORDER	7

CHAIR	8
COUNTER STOOL	10
BAR STOOL	12

CLICK THE TITLES ABOVE TO NAVIGATE THROUGH THE DOCUMENT
PRODUCT HEADERS ON SUBSEQUENT PAGES LINK BACK TO THIS PAGE

Brooks

COLORS, MATERIALS, AND FINISHES

POWDER COATED PAINTED METAL

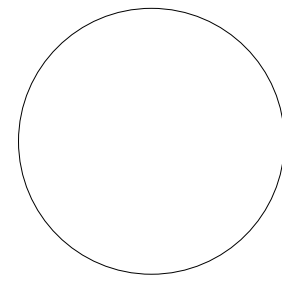

MILK
(MK)

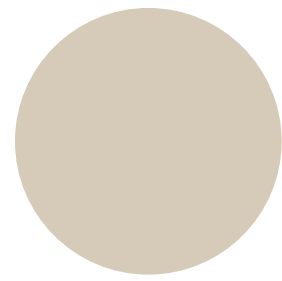

SAND
(SD)

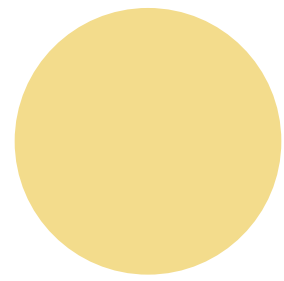

PALE YELLOW
(PY)

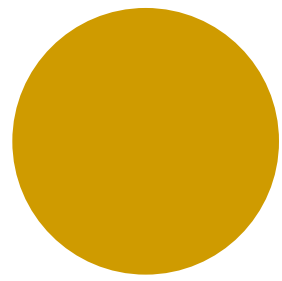

YELLOW
(YL)

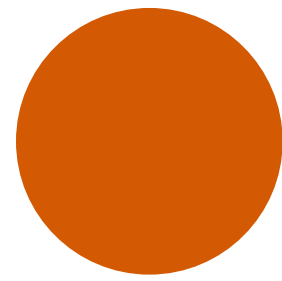

ORANGE
(OR)

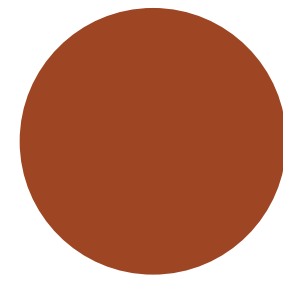

TERRACOTTA
(TC)

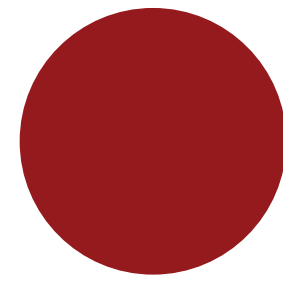

RED
(RD)

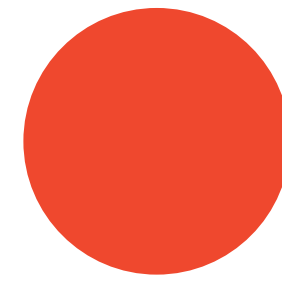

RED ORANGE
(RO)

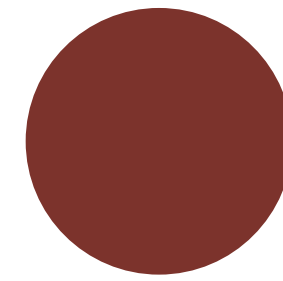

RUSTY RED
(RR)

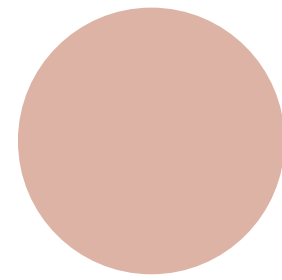

DUSTY PINK
(DP)

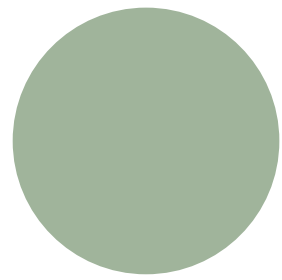

MEADOW GREEN
(MG)

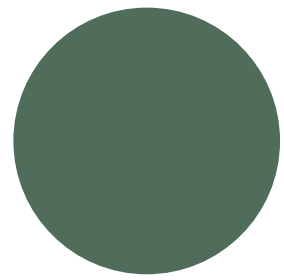

FOREST GREEN
(FG)

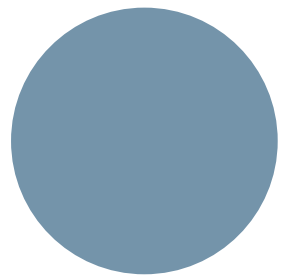

SOFT BLUE
(SB)

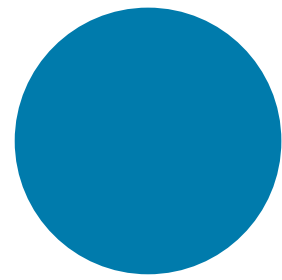

BLUE
(BL)

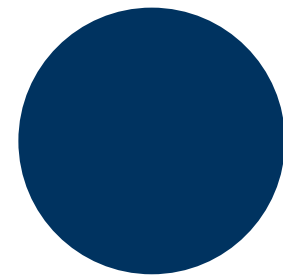

NAVY
(NV)

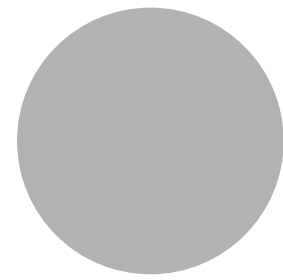

LIGHT GRAY
(LG)



CHAMPAGNE
(CP)

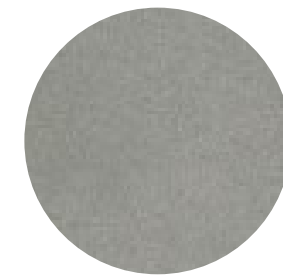

METALLIC SILVER
(MS)



NICKEL
(NK)

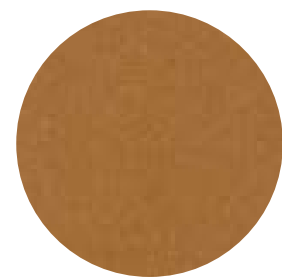

BRASS
(BR)

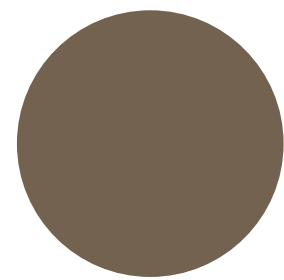

TAUPE
(TP)



DARK BRONZE
(DB)

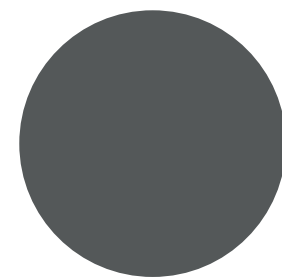

DARK GRAY
(DG)

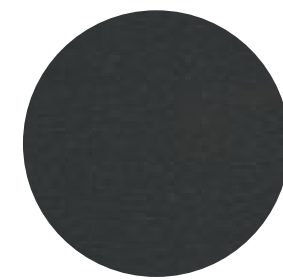

TEXTURED SLATE
(TS)

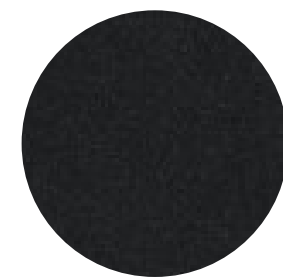

BLACK TWILIGHT
(BT)

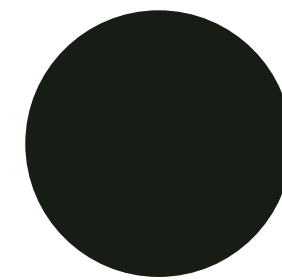

BLACK MATTE
(BM)

POLISHED METAL

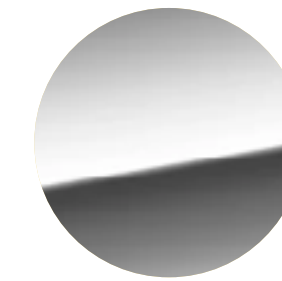

BRIGHT CHROME
(CH)

POLYPROPYLENE

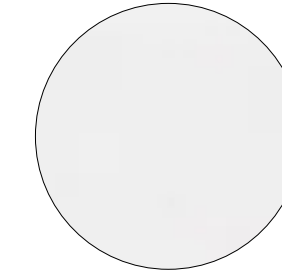

PURE WHITE
(P10)

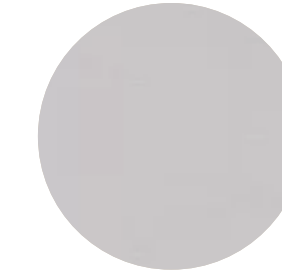

PALE GRAY
(P4)

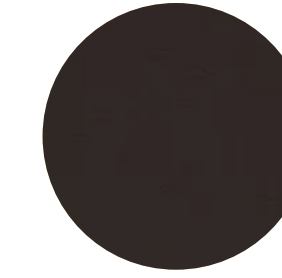

ESPRESSO
(P2)

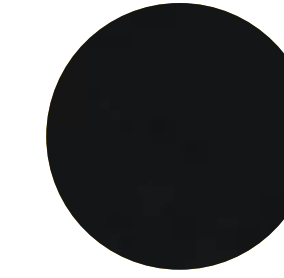

BLACK
(P1)

WOOD FINISH



ALPI RIFT
CUT OAK
(PZ30)

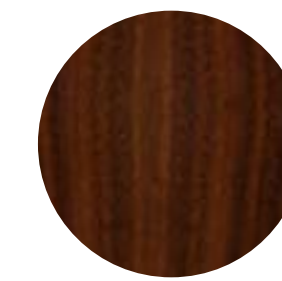

TONED WALNUT
(PZ20)

Brooks

SPECIFICATION GUIDE: OVERVIEW AND DIMENSIONS

OVERVIEW	CHAIR	COUNTER STOOL	BAR STOOL
Upholstered Seat and Wood Back, Arm and Armless Stacking Side Chair Armless: 6 High on the Floor Stacking Side Chair Arms: 6 High on the Floor Models with Wood Backs Cannot be Stacked on Dollies			
Upholstered Seat and Back, Arm and Armless Stacking Side Chair Armless: 6 High on the Floor and 10 High on Dollies Stacking Side Chair Nylon Arms: 6 High on the Floor and 10 High on Dollies Stacking Side Chair Aluminum Arms: 6 High on the Floor and 9 High on Dollies			
Poly Seat and Back, Arm and Armless Stacking Side Chair Armless: 6 High on the Floor and 12 High on Dollies () Stacking Side Chair Nylon Arms: 6 High on the Floor and 10 High on Dollies Stacking Side Chair Aluminum Arms: 6 High on the Floor and 9 High on Dollies			
Upholstered Seat and Poly Back, Arm and Armless Stacking Side Chair Armless: 6 High on the Floor and 10 High on Dollies Stacking Side Chair Nylon Arms: 6 High on the Floor and 10 High on Dollies Stacking Side Chair Aluminum Arms: 6 High on the Floor and 9 High on Dollies			
DIMENSIONS	CHAIR	COUNTER STOOL	BAR STOOL
A1. Seat Height, Wood and Poly A2. Seat Height, Upholstered B. Seat Depth C. Back Height D. Seat Width (Overall Width Armless) E. Maximum Overall Height F. Maximum Overall Depth Arm Choice, Nylon or Aluminum G. Overall Width H. Distance Between Arms I. Arm Height	 A1. 17.5 A2. 18 B. 18 C. 15.5 D. 18.5 E. 31.5 F. 21 G. 24 H. 19 I. 8.5	 A1. 25.5 A2. 26 B. 18 C. 15.5 D. 18.5 E. 39.5 F. 22 G. 24 H. 19 I. 8.5	 A1. 29.5 A2. 30 B. 18 C. 15.5 D. 18.5 E. 43.5 F. 22 G. 24 H. 19 I. 8.5
OPTIONS	Options and Accessories <div style="display: flex; justify-content: space-around; align-items: flex-start;"> <div style="text-align: center;"> Dual Upholstery </div> <div style="text-align: center;"> Wallsaver Legs </div> <div style="text-align: center;"> Transport Dolly </div> </div>		

PRODUCT INFORMATION

Design

Paul Brooks

Construction

Plastic seats and backs are injection-molded polypropylene. Upholstered seats and backs combine high-density CFC-Free polyurethane foam over polypropylene substrates. Exposed wood seats and backs are compound curved plywood with various surface veneers. Frames incorporate 7/8" square steel tube legs with 3/4" square tube cross-stretchers. The back is attached using two cast aluminum supports which are staked into the rear legs. Arms may be either glass-filled nylon or cast aluminum. The stack pad is injection-molded plastic. All attachments are concealed.

Stacking

See accompanying chart for specific quantities that may be stacked on the floor or on a dolly. No chairs with wood backs may be stacked on dollies. Furthermore, only chairs with chrome frames may be stacked on dollies.

Glides

Glides are either plastic or plastic with felt pads.

Ganging

Not available.

Wood Finishes

The beauty of wood consists of its being a product of nature. As such, exposed wood surfaces will not offer the same consistency as man-made materials. Some variation in color, grain, and texture are to be expected, even within the same order. Another consideration is that wood components will tend to darken over time, exaggerating slightly naturally occurring differences. Chairs ordered at different times are likely to be less similar than those ordered together. Therefore, Stylex will not guarantee a precise match of color, grain, or texture of its wood components.

Use

Designed for indoor use only.

Performance Standards

Manufactured to comply with:
ANSI/BIFMA X5.1 General-Purpose Office Chairs - Tests

Certifications

GREENGUARD Gold
LEVEL® 1

Brooks

SPECIFICATION GUIDE: DOLLY DIMENSIONS

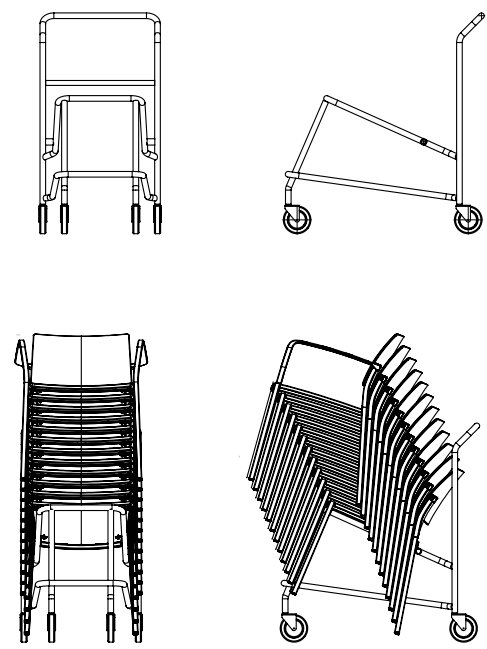
DIMENSIONS	ARMLESS	NYLON ARM	ALUMINUM ARM
<p>A. Width B. Depth C. Height</p> 	<p>Upholstered Seat and Back (10 High)</p> <p>A. 21.75 B. 39.75 C. 58.25</p>	<p>Upholstered Seat and Back (10 High)</p> <p>A. 23.75 B. 39.75 C. 58.25</p>	<p>Upholstered Seat and Back (9 High)</p> <p>A. 23.75 B. 38.75 C. 55.5</p>
	<p>Poly Seat and Back (12 High)</p> <p>A. 21.75 B. 41.25 C. 55.25</p>	<p>Poly Seat and Back (10 High)</p> <p>A. 23.75 B. 39.5 C. 51</p>	<p>Poly Seat and Back (9 High)</p> <p>A. 23.75 B. 38.75 C. 48.75</p>
	<p>Upholstered Seat and Poly Back (10 High)</p> <p>A. 21.75 B. 39.75 C. 58.25</p>	<p>Upholstered Seat and Poly Back (10 High)</p> <p>A. 23.75 B. 39.75 C. 58.25</p>	<p>Upholstered Seat and Poly Back (9 High)</p>

PRODUCT INFORMATION

Design

Paul Brooks

Construction

Plastic seats and backs are injection-molded polypropylene. Upholstered seats and backs combine high-density CFC-Free polyurethane foam over polypropylene substrates. Exposed wood seats and backs are compound curved plywood with various surface veneers. Frames incorporate 7/8" square steel tube legs with 3/4" square tube cross-stretchers. The back is attached using two cast aluminum supports which are staked into the rear legs. Arms may be either glass-filled nylon or cast aluminum. The stack pad is injection-molded plastic. All attachments are concealed.

Stacking

See accompanying chart for specific quantities that may be stacked on the floor or on a dolly. No chairs with wood backs may be stacked on dollies. Furthermore, only chairs with chrome frames may be stacked on dollies.

Glides

Glides are either plastic or plastic with felt pads.

Ganging

Not available.

Wood Finishes

The beauty of wood consists of its being a product of nature. As such, exposed wood surfaces will not offer the same consistency as man-made materials. Some variation in color, grain, and texture are to be expected, even within the same order. Another consideration is that wood components will tend to darken over time, exaggerating slightly naturally occurring differences. Chairs ordered at different times are likely to be less similar than those ordered together. Therefore, Stylex will not guarantee a precise match of color, grain, or texture of its wood components.

Use

Designed for indoor use only.

Testing

Manufactured to comply with ANSI/BIFMA x5.1 General Office Chair test.

Environment

Greenguard Certified.

Brooks

SPECIFICATION GUIDE: HOW TO ORDER

MODEL CODE BREAKDOWN

Sample Model Code: BR24WSPGN1BMDCOM

1. Series	2. Frame	3. Style	4. Back Type	5. Glides	6. Arm Finish	7. Frame Finish	8. Seat Finish	9. Back Finish
BR	2	3	WS	PG	N1	BM	D	COM
Series BR BROOKS	Frame 1 ARMLESS CHAIR 2 ARM CHAIR 7 ARMLESS BAR STOOL 8 ARM BAR STOOL 9 ARMLESS COUNTER STOOL 0 ARM COUNTER STOOL	Style 3 UPHOLSTERED SEAT AND WOOD BACK 4 UPHOLSTERED SEAT AND BACK 5 POLY SEAT AND BACK 6 UPHOLSTERED SEAT AND POLY BACK	Options DF DUAL UPHOLSTERY WS WALLSAVER LEGS CT CONTRASTING THREAD Accessories BRTD BROOKS TRANSPORT DOLLY Finish Advisory for Dolly Use Stylex recommends chrome frames for any stacking application requiring dollies. We will not warrant powder coated frames used on dollies against damage to the finish. In addition, appropriate care must be exercised when stacking powder coated chairs on the floor.	Glides PG PLASTIC GLIDES FG PLASTIC GLIDES WITH FELT PADS	Nylon Arm N1 BLACK N2 ESPRESSO N4 PALE GRAY N10 PURE WHITE Aluminum Arm A ALUMINUM ARMS Note: Aluminum arms will match frame finish	Standard Powder Coated Metal BL BLUE BM BLACK MATTE BR BRASS BT BLACK TWILIGHT CP CHAMPAGNE DB DARK BRONZE DG DARK GRAY DP DUSTY PINK FG FOREST GREEN LG LIGHT GRAY MG MEADOW GREEN MK MILK MS METALLIC SILVER NK NICKEL NV NAVY OR ORANGE PY PALE YELLOW RD RED RO RED ORANGE RR RUSTY RED SB SOFT BLUE SD SAND TC TERRACOTTA TP TAUPE TS TEXTURED SLATE YL YELLOW Chrome CH BRIGHT CHROME	Poly Finish P1 BLACK P2 ESPRESSO P4 PALE GRAY P10 PURE WHITE Textile Grades COM CUSTOMER'S OWN MATERIAL A GRADE A B GRADE B C GRADE C D GRADE D E GRADE E F GRADE F G GRADE G H GRADE H I GRADE I J GRADE J K GRADE K L GRADE L M GRADE M Leather Grades COL CUSTOMER'S OWN LEATHER W GRADE W X GRADE X Y GRADE Y E1 GRADE E1 E2 GRADE E2 Note: Select highest grade in the case of dual upholstery	Poly Finish P1 BLACK P2 ESPRESSO P4 PALE GRAY P10 PURE WHITE Wood Finish PZ20 TONED WALNUT PZ30 ALPI RIFT CUT OAK Textile Grades COM CUSTOMER'S OWN MATERIAL A GRADE A H GRADE H B GRADE B I GRADE I C GRADE C J GRADE J D GRADE D K GRADE K E GRADE E L GRADE L F GRADE F M GRADE M G GRADE G Leather Grades COL CUSTOMER'S OWN LEATHER W GRADE W X GRADE X Y GRADE Y E1 GRADE E1 E2 GRADE E2 Note: Select highest grade in the case of dual upholstery

Brooks

CHAIR: ARMLESS

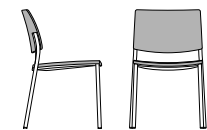
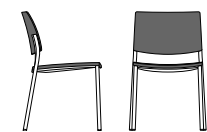
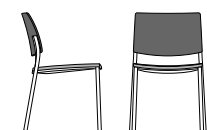
TITLE	SERIES	FRAME	STYLE	DIMENSIONS	Textile Upholstery Grades										Leather Upholstery Grades									
					COM	COL	COM					COL					W	X	Y	E1	E2			
					YDG	SQFT	A	B	C	D	E	F	G	H	I	J						K	L	M
Chair, Armless, Upholstered Seat and Wood Back 	BR	1	3	18.5W x 21D x 31.5H	0.4	6	836	859	876	897	918	939	962	987	1,011	1,040	1,083	1,118	1,152	1,038	1,064	1,180	1,241	1,333
Chair, Armless, Upholstered Seat and Back 	BR	1	4	18.5W x 21D x 31.5H	1	14	757	809	859	908	961	1,012	1,065	1,130	1,193	1,262	1,369	1,456	1,541	1,125	1,174	1,389	1,502	1,674
Chair, Armless, Poly Seat and Poly Back 	BR	1	5	18.5W x 21D x 31.5H	0	0	549																	
Chair, Armless, Upholstered Seat and Poly Back 	BR	1	6	18.5W x 21D x 31.5H	0.4	6	669	687	710	727	750	771	791	818	840	870	912	947	981	869	895	1,012	1,073	1,166

To Order Select Below

1. Series/Frame

BR1

Brooks Chair, Armless

2. Style

3 UPHOLSTERED SEAT AND WOOD BACK

4 UPHOLSTERED SEAT AND BACK

5 POLY SEAT AND POLY BACK

6 UPHOLSTERED SEAT AND POLY BACK

3. Options

DF DUAL UPHOLSTERY

WS WALLSAVER LEGS **+16**

CT CONTRASTING THREAD

Accessories

BRTD BROOKS TRANSPORT DOLLY **+1339**

Finish Advisory for Dolly Use
 Stylex recommends chrome frames for any stacking application requiring dollies. We will not warrant powder coated frames used on dollies against damage to the finish. In addition, appropriate care must be exercised when stacking powder coated chairs on the floor.

4. Glides

PG PLASTIC GLIDES

FG PLASTIC GLIDES WITH FELT PADS

5. Frame Finish

Standard Powder Coated Metal

BL BLUE

BM BLACK MATTE

BR BRASS

BT BLACK TWILIGHT

CP CHAMPAGNE

DB DARK BRONZE

DG DARK GRAY

DP DUSTY PINK

FG FOREST GREEN

LG LIGHT GRAY

MG MEADOW GREEN

MK MILK

MS METALLIC SILVER

Chrome

CH BRIGHT CHROME **+174**

NK NICKEL

NV NAVY

OR ORANGE

PY PALE YELLOW

RD RED

RO RED ORANGE

RR RUSTY RED

SB SOFT BLUE

SD SAND

TC TERRACOTTA

TP TAUPE

TS TEXTURED SLATE

YL YELLOW

6. Seat Finish

Poly Finish

P1 BLACK

P2 ESPRESSO

P4 PALE GRAY

P10 PURE WHITE

Upholstery

See general information section for details on textile program and COM/COL info.

7. Back Finish

Poly Finish

P1 BLACK

P2 ESPRESSO

P4 PALE GRAY

P10 PURE WHITE

Wood Finish

PZ20 TONED WALNUT **+112**

PZ30 ALPI RIFT CUT OAK **+112**

09 CUSTOM COLOR **+375**

Custom Color is per order per color 100 chair minimum. Contact customer service for details.

Upholstery

See general information section for details on textile program and COM/COL info.

Brooks

CHAIR: ARM

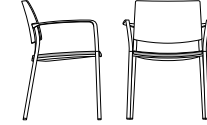
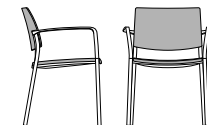
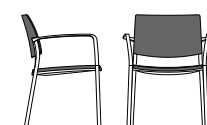
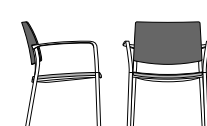
TITLE	SERIES	FRAME	STYLE	DIMENSIONS	Textile Upholstery Grades															Leather Upholstery Grades				
					COM	COL	COM					COL					W	X	Y	E1	E2			
					YDG	SQFT	A	B	C	D	E	F	G	H	I	J						K	L	M
Chair, Arm, Upholstered Seat and Wood Back 	BR	2	3	24W x 21D x 31.5H	0.4	6	918	937	960	978	998	1,020	1,043	1,068	1,092	1,121	1,164	1,199	1,233	1,120	1,145	1,261	1,322	1,413
Chair, Arm, Upholstered Seat and Back 	BR	2	4	24W x 21D x 31.5H	1	14	836	888	937	988	1,040	1,093	1,146	1,209	1,274	1,344	1,451	1,539	1,624	1,205	1,252	1,470	1,584	1,757
Chair, Arm, Poly Seat and Poly Back 	BR	2	5	24W x 21D x 31.5H	0	0	628																	
Chair, Arm, Upholstered Seat and Poly Back 	BR	2	6	24W x 21D x 31.5H	0.4	6	750	769	789	810	831	853	873	897	923	950	993	1,028	1,062	949	974	1,093	1,155	1,249

To Order Select Below

<p>1. Series/Frame</p> <p>BR2</p> <p>Brooks Chair, Arm</p>	<p>2. Style</p> <p>3 UPHOLSTERED SEAT AND WOOD BACK</p> <p>4 UPHOLSTERED SEAT AND BACK</p> <p>5 POLY SEAT AND POLY BACK</p> <p>6 UPHOLSTERED SEAT AND POLY BACK</p>	<p>3. Options</p> <p>DF DUAL UPHOLSTERY</p> <p>WS WALLSAVER LEGS +16</p> <p>CT CONTRASTING THREAD</p> <p>Accessories</p> <p>BRTD BROOKS TRANSPORT DOLLY +1339</p> <p>Finish Advisory for Dolly Use Stylex recommends chrome frames for any stacking application requiring dollies. We will not warrant powder coated frames used on dollies against damage to the finish. In addition, appropriate care must be exercised when stacking powder coated chairs on the floor.</p>	<p>4. Glides</p> <p>PG PLASTIC GLIDES</p> <p>FG PLASTIC GLIDES WITH FELT PADS</p>	<p>5. Arm Finish</p> <p>N1 BLACK</p> <p>N2 ESPRESSO</p> <p>N4 PALE GRAY</p> <p>N10 PURE WHITE</p> <p>Aluminum Arm</p> <p>A ALUMINUM ARM +91</p> <p>Aluminum arms will match frame finish</p>	<p>6. Frame Finish</p> <p>Standard Powder Coated Metal</p> <p>BL BLUE</p> <p>BM BLACK MATTE</p> <p>BR BRASS</p> <p>BT BLACK TWILIGHT</p> <p>CP CHAMPAGNE</p> <p>DB DARK BRONZE</p> <p>DG DARK GRAY</p> <p>DP DUSTY PINK</p> <p>FG FOREST GREEN</p> <p>LG LIGHT GRAY</p> <p>MG MEADOW GREEN</p> <p>MK MILK</p> <p>MS METALLIC SILVER</p> <p>Chrome</p> <p>CH BRIGHT CHROME +238</p> <p>NK NICKEL</p> <p>NV NAVY</p> <p>OR ORANGE</p> <p>PY PALE YELLOW</p> <p>RD RED</p> <p>RO RED ORANGE</p> <p>RR RUSTY RED</p> <p>SB SOFT BLUE</p> <p>SD SAND</p> <p>TC TERRACOTTA</p> <p>TP TAUPE</p> <p>TS TEXTURED SLATE</p> <p>YL YELLOW</p>	<p>7. Seat Finish</p> <p>P1 BLACK</p> <p>P2 ESPRESSO</p> <p>P4 PALE GRAY</p> <p>P10 PURE WHITE</p> <p>Upholstery</p> <p>See general information section for details on textile program and COM/COL info.</p>	<p>8. Back Finish</p> <p>P1 BLACK</p> <p>P2 ESPRESSO</p> <p>P4 PALE GRAY</p> <p>P10 PURE WHITE</p> <p>Wood Finish</p> <p>PZ20 TONED WALNUT +112</p> <p>PZ30 ALPI RIFT CUT OAK +112</p> <p>09 CUSTOM COLOR +375</p> <p>Custom Color is per order per color 100 chair minimum. Contact customer service for details.</p> <p>Upholstery</p> <p>See general information section for details on textile program and COM/COL info.</p>
--	--	---	--	---	--	--	--

Brooks

COUNTER STOOL: ARMLESS

TITLE	SERIES	FRAME	STYLE	DIMENSIONS	COM YDG	COL SQFT	Textile Upholstery Grades										Leather Upholstery Grades							
							COM					COL					W	X	Y	E1	E2			
							A	B	C	D	E	F	G	H	I	J						K	L	M
Counter Stool, Armless, Upholstered Seat and Wood Back	BR	9	3	18.5W x 22D x 39.5H	0.4	6	1,190	1,210	1,233	1,250	1,273	1,293	1,317	1,339	1,363	1,393	1,436	1,471	1,504	1,392	1,418	1,535	1,596	1,689
Counter Stool, Armless, Upholstered Seat and Back	BR	9	4	18.5W x 22D x 39.5H	1	14	1,111	1,161	1,210	1,261	1,313	1,364	1,420	1,485	1,546	1,617	1,724	1,812	1,897	1,478	1,529	1,741	1,853	2,024
Counter Stool, Armless, Poly Seat and Poly Back	BR	9	5	18.5W x 22D x 39.5H	0	0	899																	
Counter Stool, Armless, Upholstered Seat and Poly Back	BR	9	6	18.5W x 22D x 39.5H	0.4	6	1,021	1,044	1,063	1,083	1,100	1,125	1,146	1,173	1,195	1,224	1,267	1,302	1,336	1,222	1,247	1,364	1,425	1,518

To Order Select Below

1. Series/Frame

BR9

Brooks Counter Stool, Armless

2. Style

3 UPHOLSTERED SEAT AND WOOD BACK

4 UPHOLSTERED SEAT AND BACK

5 POLY SEAT AND POLY BACK

6 UPHOLSTERED SEAT AND POLY BACK

3. Options

DF DUAL UPHOLSTERY

WS WALLSAVER LEGS **+16**

CT CONTRASTING THREAD

4. Glides

PG PLASTIC GLIDES

FG PLASTIC GLIDES WITH FELT PADS

5. Frame Finish

Standard Powder Coated Metal

BL BLUE

BM BLACK MATTE

BR BRASS

BT BLACK TWILIGHT

CP CHAMPAGNE

DB DARK BRONZE

DG DARK GRAY

DP DUSTY PINK

FG FOREST GREEN

LG LIGHT GRAY

MG MEADOW GREEN

MK MILK

MS METALLIC SILVER

Chrome

CH BRIGHT CHROME **+207**

NK NICKEL

NV NAVY

OR ORANGE

PY PALE YELLOW

RD RED

RO RED ORANGE

RR RUSTY RED

SB SOFT BLUE

SD SAND

TC TERRACOTTA

TP TAUPE

TS TEXTURED SLATE

YL YELLOW

6. Seat Finish

Poly Finish

P1 BLACK

P2 ESPRESSO

P4 PALE GRAY

P10 PURE WHITE

Upholstery

See general information section for details on textile program and COM/COL info.

7. Back Finish

Poly Finish

P1 BLACK

P2 ESPRESSO

P4 PALE GRAY

P10 PURE WHITE

Wood Finish

PZ20 TONED WALNUT **+112**

PZ30 ALPI RIFT CUT OAK **+112**

09 CUSTOM COLOR **+375**

Custom Color is per order per color 100 chair minimum. Contact customer service for details.

Upholstery

See general information section for details on textile program and COM/COL info.

Brooks

COUNTER STOOL: ARM

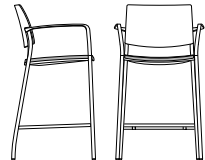
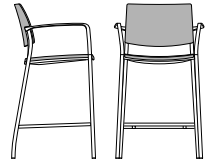
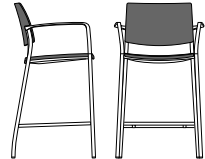
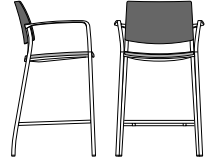
TITLE	SERIES	FRAME	STYLE	DIMENSIONS	COM YDG	COL SQFT	Textile Upholstery Grades										Leather Upholstery Grades							
							COM					COL					W	X	Y	E1	E2			
							A	B	C	D	E	F	G	H	I	J						K	L	M
Counter Stool, Arm, Upholstered Seat and Wood Back 	BR	0	3	24W x 22D x 39.5H	0.4	6	1,273	1,292	1,310	1,331	1,351	1,376	1,394	1,421	1,445	1,474	1,516	1,551	1,585	1,473	1,497	1,616	1,678	1,771
Counter Stool, Arm, Upholstered Seat and Back 	BR	0	4	24W x 22D x 39.5H	1	14	1,190	1,242	1,292	1,342	1,393	1,447	1,499	1,563	1,625	1,698	1,803	1,891	1,976	1,560	1,607	1,823	1,936	2,107
Counter Stool, Arm, Poly Seat and Poly Back 	BR	0	5	24W x 22D x 39.5H	0	0	981																	
Counter Stool, Arm, Upholstered Seat and Poly Back 	BR	0	6	24W x 22D x 39.5H	0.4	6	1,100	1,124	1,143	1,162	1,181	1,205	1,225	1,250	1,276	1,304	1,347	1,382	1,416	1,302	1,329	1,447	1,509	1,603

To Order Select Below

1. Series/Frame

BR0

Brooks Counter Stool, Arm

2. Style

3 UPHOLSTERED SEAT AND WOOD BACK

4 UPHOLSTERED SEAT AND BACK

5 POLY SEAT AND POLY BACK

6 UPHOLSTERED SEAT AND POLY BACK

3. Options

DF DUAL UPHOLSTERY

WS WALLSAVER LEGS **+16**

CT CONTRASTING THREAD

4. Glides

PG PLASTIC GLIDES

FG PLASTIC GLIDES WITH FELT PADS

6. Frame Finish

Standard Powder Coated Metal

BL BLUE

BM BLACK MATTE

BR BRASS

BT BLACK TWILIGHT

CP CHAMPAGNE

DB DARK BRONZE

DG DARK GRAY

DP DUSTY PINK

FG FOREST GREEN

LG LIGHT GRAY

MG MEADOW GREEN

MK MILK

MS METALLIC SILVER

Chrome

CH BRIGHT CHROME **+271**

6. Seat Finish

Poly Finish

P1 BLACK

P2 ESPRESSO

P4 PALE GRAY

P10 PURE WHITE

Upholstery

See general information section for details on textile program and COM/COL info.

7. Back Finish

Poly Finish

P1 BLACK

P2 ESPRESSO

P4 PALE GRAY

P10 PURE WHITE

Wood Finish

PZ20 TONED WALNUT **+112**

PZ30 ALPI RIFT CUT OAK **+112**

09 CUSTOM COLOR **+375**

Custom Color is per order per color 100 chair minimum. Contact customer service for details.

Upholstery

See general information section for details on textile program and COM/COL info.

Brooks

BAR STOOL: ARMLESS

TITLE	SERIES	FRAME	STYLE	DIMENSIONS	Textile Upholstery Grades										Leather Upholstery Grades									
					COM	COL	COM					COL					W	X	Y	E1	E2			
					YDG	SQFT	A	B	C	D	E	F	G	H	I	J						K	L	M
Bar Stool, Armless, Upholstered Seat and Wood Back	BR	7	3	18.5W x 22D x 43.5H	0.4	6	1,190	1,210	1,233	1,250	1,273	1,293	1,317	1,339	1,363	1,393	1,436	1,471	1,504	1,392	1,418	1,535	1,596	1,689
Bar Stool, Armless, Upholstered Seat and Back	BR	7	4	18.5W x 22D x 43.5H	1	14	1,111	1,161	1,210	1,261	1,313	1,364	1,420	1,485	1,546	1,617	1,724	1,812	1,897	1,478	1,529	1,741	1,853	2,024
Bar Stool, Armless, Poly Seat and Poly Back	BR	7	5	18.5W x 22D x 43.5H	0	0	899																	
Bar Stool, Armless, Upholstered Seat and Poly Back	BR	7	6	18.5W x 22D x 43.5H	0.4	6	1,021	1,044	1,063	1,083	1,100	1,125	1,146	1,173	1,195	1,224	1,267	1,302	1,336	1,222	1,247	1,364	1,425	1,518

To Order Select Below

1. Series/Frame

BR7

Brooks Bar Stool, Armless

2. Style

3 UPHOLSTERED SEAT AND WOOD BACK

4 UPHOLSTERED SEAT AND BACK

5 POLY SEAT AND POLY BACK

6 UPHOLSTERED SEAT AND POLY BACK

3. Options

DF DUAL UPHOLSTERY

WS WALLSAVER LEGS **+16**

CT CONTRASTING THREAD

4. Glides

PG PLASTIC GLIDES

FG PLASTIC GLIDES WITH FELT PADS

5. Arm Finish

Nylon Arm

N1 BLACK

N2 ESPRESSO

N4 PALE GRAY

N10 PURE WHITE

Aluminum Arm

A ALUMINUM ARM **+91**

Aluminum arms will match frame finish

5. Frame Finish

Standard Powder Coated Metal

BL BLUE

BM BLACK MATTE

BR BRASS

BT BLACK TWILIGHT

CP CHAMPAGNE

DB DARK BRONZE

DG DARK GRAY

DP DUSTY PINK

FG FOREST GREEN

LG LIGHT GRAY

MG MEADOW GREEN

MK MILK

MS METALLIC SILVER

Chrome

CH BRIGHT CHROME **+207**

NK NICKEL

NV NAVY

OR ORANGE

PY PALE YELLOW

RD RED

RO RED ORANGE

RR RUSTY RED

SB SOFT BLUE

SD SAND

TC TERRACOTTA

TP TAUPE

TS TEXTURED SLATE

YL YELLOW

7. Seat Finish

Poly Finish

P1 BLACK

P2 ESPRESSO

P4 PALE GRAY

P10 PURE WHITE

Upholstery

See general information section for details on textile program and COM/COL info.

8. Back Finish

Poly Finish

P1 BLACK

P2 ESPRESSO

P4 PALE GRAY

P10 PURE WHITE

Wood Finish

PZ20 TONED WALNUT **+112**

PZ30 ALPI RIFT CUT OAK **+112**

09 CUSTOM COLOR **+375**

Custom Color is per order per color 100 chair minimum. Contact customer service for details.

Upholstery

See general information section for details on textile program and COM/COL info.

Brooks

BAR STOOL: ARM

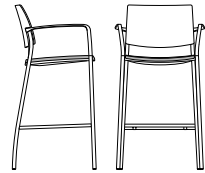
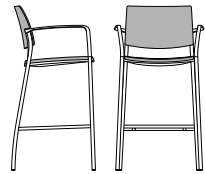
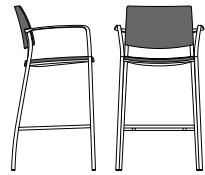
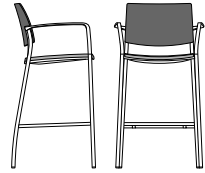
TITLE	SERIES	FRAME	STYLE	DIMENSIONS	Textile Upholstery Grades										Leather Upholstery Grades										
					COM	COL	COM					COL					W	X	Y	E1	E2				
					YDG	SQFT	A	B	C	D	E	F	G	H	I	J						K	L	M	
Bar Stool, Arm, Upholstered Seat and Wood Back		BR	8	3	24W x 22D x 43.5H	0.4	6	1,273	1,292	1,310	1,331	1,351	1,376	1,394	1,421	1,445	1,474	1,516	1,551	1,585	1,473	1,497	1,616	1,678	1,771
Bar Stool, Arm, Upholstered Seat and Back		BR	8	4	24W x 22D x 43.5H	1	14	1,190	1,242	1,292	1,342	1,393	1,447	1,499	1,563	1,625	1,698	1,803	1,891	1,976	1,560	1,607	1,823	1,936	2,107
Bar Stool, Arm, Poly Seat and Poly Back		BR	8	5	24W x 22D x 43.5H	0	0	981																	
Bar Stool, Arm, Upholstered Seat and Poly Back		BR	8	6	24W x 22D x 43.5H	0.4	6	1,100	1,124	1,143	1,162	1,181	1,205	1,225	1,250	1,276	1,304	1,347	1,382	1,416	1,302	1,329	1,447	1,509	1,603

To Order Select Below

1. Series/Frame

BR8

Brooks Bar Stool, Arm

2. Style

3 UPHOLSTERED SEAT AND WOOD BACK

4 UPHOLSTERED SEAT AND BACK

5 POLY SEAT AND POLY BACK

6 UPHOLSTERED SEAT AND POLY BACK

3. Options

DF DUAL UPHOLSTERY

WS WALLSAVER LEGS **+16**

CT CONTRASTING THREAD

4. Glides

PG PLASTIC GLIDES

FG PLASTIC GLIDES WITH FELT PADS

5. Arm Finish

N1 BLACK

N2 ESPRESSO

N4 PALE GRAY

N10 PURE WHITE

Aluminum Arm

A ALUMINUM ARM **+91**

Aluminum arms will match frame finish

6. Frame Finish

Standard Powder Coated Metal

BL BLUE

BM BLACK MATTE

BR BRASS

BT BLACK TWILIGHT

CP CHAMPAGNE

DB DARK BRONZE

DG DARK GRAY

DP DUSTY PINK

FG FOREST GREEN

LG LIGHT GRAY

MG MEADOW GREEN

MK MILK

MS METALLIC SILVER

Chrome

CH BRIGHT CHROME **+271**

NK NICKEL

NV NAVY

OR ORANGE

PY PALE YELLOW

RD RED

RO RED ORANGE

RR RUSTY RED

SB SOFT BLUE

SD SAND

TC TERRACOTTA

TP TAUPE

TS TEXTURED SLATE

YL YELLOW

7. Seat Finish

P1 BLACK

P2 ESPRESSO

P4 PALE GRAY

P10 PURE WHITE

Upholstery

See general information section for details on textile program and COM/COL info.

8. Back Finish

P1 BLACK

P2 ESPRESSO

P4 PALE GRAY

P10 PURE WHITE

Wood Finish

PZ20 TONED WALNUT **+112**

PZ30 ALPI RIFT CUT OAK **+112**

09 CUSTOM COLOR **+375**

Custom Color is per order per color 100 chair minimum. Contact customer service for details.

Upholstery

See general information section for details on textile program and COM/COL info.

stylex

Click

PRICE LIST

Effective November 01, 2023

Updated January 12, 2024

General Information

GENERAL INFORMATION

Terms

Net 30 days from date of invoice,
F. O. B . Delanco, New Jersey.

Damaged Shipments

All Stylex products are carefully inspected before they are packed in sturdy cartons designed to satisfy shipping requirements. Stylex is not responsible for damage in shipment. The transportation company assumes responsibility for delivering products to you in good condition when the bill of lading is signed. You protect yourself by refusing shipments showing damage or shortage until transportation company has noted on the delivery sheet the extent of damage or shortage. Concealed damage should be reported to the carrier as soon as discovered, but not later than 15 days after receiving shipment.

Return/Restocking Policy

Return shipments will not be accepted unless specifically authorized by Stylex in writing. The Return Authorization number should be clearly marked on the carton. The customer returning Stylex products is responsible for return shipping costs. Merchandise must be returned unused. Returned merchandise is subject to a 35% restocking fee.

Custom Products

Modifications to standard products will be considered for large runs. Contact factory for price quotations.

Design Changes

In keeping with modern manufacturing advances, Stylex reserves the right to incorporate minor modifications and design changes in products without notice.

Cancellation Policy

No charge prior to production except for inventory specifically requisitioned to fulfill the particular order. After production has begun, only actual costs incurred, including labor and material, will be billed to the customer.

WARRANTY

Except as provided below, Stylex warrants exclusively to the original Purchaser of our product that all parts, under normal use and service, will be free from defects in workmanship and material for a period of ten (10) years from the date of purchase. "Normal use and service" means that the product will be used in a typical office environment for 40-45 hours per week.

This warranty is subject to the following limitations, exclusions and provisions:

Limitations involving materials and components:

Wood components of plywood stacking chairs
(such as Brooks and Welcome)
5 years

Upholstery

(including mesh used for Click, F4, Insight, and Zephyr Mesh)
3 years

SAVA Mesh

10 years

COM Upholstery

No warranty
Stylex makes every effort to ensure that the COM Upholstery it approves is suitable for the intended use. Nevertheless, we will not warrant, and assume no responsibility for, the durability or tailoring quality of any COM or COL. If you have any concerns about the ultimate appearance of any covering, please order an upholstered sample.

Painted Stack Chair Frames

No Warranty

We will not warrant the finish of painted stack chair frames against damage from stacking. Please order chrome frames for chairs that will be stacked.

Felt Glides

No warranty

Due to the different surfaces on which felt glides may be used, we cannot warrant their durability over time.

If this product fails during normal use and service within the applicable warranty period (other than through normal wear and tear), please send a description of the relevant part and the nature of the defect, together with proof of purchase of the product, to Stylex at: Customer Service. c/o Stylex, P.O. Box 5038, Delanco, NJ 08075. PLEASE DO NOT RETURN PARTS OR THE PRODUCT TO STYLEX UNLESS INSTRUCTED TO DO SO BY STYLEX. Stylex will, at its option, either repair or replace the product or the part found defective by Stylex completely without charge for materials or labor. Purchaser may be required (at the option of Stylex) to return to Stylex at Purchaser's expense any defective part with all freight or shipping charges prepaid. The foregoing warranty shall be void if the product has been altered or repaired (other than by Stylex). The warranty does not cover damage to the product caused by accident, neglect, misuse, abuse, modification to the product by anyone other than Stylex or damage caused by use of the product for a purpose other than that for which it was designed. This warranty extends only to the original Purchaser of the product.

No Other Warranties

This warranty is in lieu of all other warranties, expressed or implied, including, but not limited to, implied warranties of merchantability and fitness for a particular purpose. The rights and remedies provided herein are the exclusive rights and remedies of the original purchaser of the product.

No Liability For Damages

In no event shall Stylex or its suppliers be responsible or liable for any special, indirect, consequential, or incidental damages. In no event shall the liability of Stylex exceed the actual purchase price paid to Stylex for the product.

Out of Warranty Products

For all products no longer covered by our warranty, please refer to our Design for Durability and Upgradability Policy. Contact Customer Service if you would like to purchase any replaceable components to further extend the life of any Stylex seating product. This warranty applies to all Stylex products purchased on April 13, 2018, and thereafter.

PRODUCT TAKE BACK PROGRAM

In order to be good stewards of our products, Stylex offers a pathway towards a Product Take Back Program as a more viable solution to the end of our products' originally intended life.

Stylex supports the sustainable programs of ANEW and offers their added value to our clients through a comprehensive take-back solution for surplus office furniture and materials of any kind, in any condition. ANEW is a 501(c)(3) non-profit organization that exists to provide companies with smart, cost effective alternatives for their surplus furniture and other items with the priority of matching it to non-profits, public agencies and the underserved, within the local community of the project site. Corporate Social Responsibility is raised while the impact on the environment is lowered by diverting products and materials otherwise destined for landfill.

Stylex is proud to offer ANEW to customers dedicated to strengthening their community network by repurposing their furniture, fixtures and architectural materials to those in need. In 2014, Stylex committed to making this relationship a part of our strategic sales strategy. Visit www.anewfound.org to find out more.

To initiate a Product Take Back strategy through ANEW, contact Stylex Customer Service at 800-257-5742.

For other end of life recovery options, please see our Product Disassembly Instructions and End of Life Recovery Options documents available on our website in the resources section of each product in our line.

FREIGHT PROGRAM

Stylex offers a Guaranteed Freight Program, which provides the purchaser the ability to determine shipping and handling charges at the time of order. Freight charges will be calculated as a percentage of the net product price and added to the invoice at the time of shipment. The continental United States has been divided into three zones. Please use the map below to determine the freight charges for the product's destination. There is a minimum freight charge of \$150.

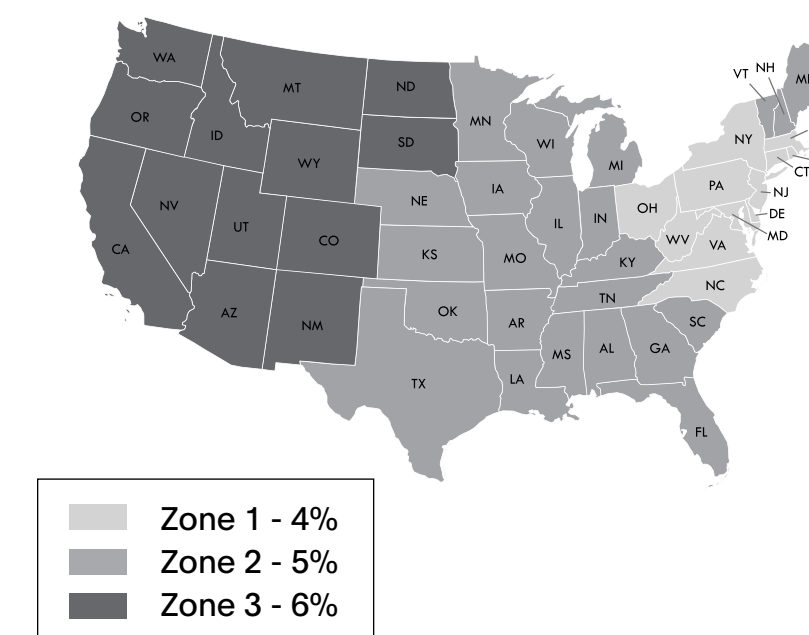

ZONE 1 - 4%

Connecticut
Delaware
New York
New Jersey
Maryland
Massachusetts
North Carolina
Ohio
Pennsylvania
Rhode Island
Virginia
Washington D.C.
West Virginia

ZONE 2 - 5%

Alabama
Arkansas
Canada, Ontario
Canada, Quebec
Florida
Georgia
Iowa
Illinois
Indiana
Kansas
Kentucky
Louisiana
Nebraska
New Hampshire
Oklahoma
Maine
Michigan
Minnesota
Missouri
Mississippi
South Carolina
Tennessee
Texas
Vermont
Wisconsin

ZONE 3 - 6%

Arizona
California
Colorado
Idaho
Montana
Nevada
New Mexico
North Dakota
Oregon
South Dakota
Utah
Washington
Wyoming

Quote Per Project
Alaska
Hawaii
Canada
(outside Ontario & Quebec)
Mexico

General Information

TEXTILE PARTNERS & APPROVALS

Textile Partners

To customize your furniture performance needs and design vision, Stylex offers a wide selection of in-graded leathers and textiles from Grades A through Y. We've partnered with leading manufacturers on the options, focusing on color, price, durability, and construction. To view our partners and explore our digital carded program with broadly approved textiles, visit [this page](#). We stand by these textiles: They're tried and tested, and will effortlessly fit into any design aesthetic.

Textile Approvals

To view Stylex Approved Textile documents to determine specific product approval status, visit [this page](#).

CAL 117 AND 133 COMPLIANCE

CAL 117-2013

All Stylex seating satisfies the requirements of CAL 117-2013 so long as one of our standard or in-graded fabrics is applied. COM textiles cannot be so guaranteed. Please contact the supplier of COM's directly to determine the fire retardancy of any COM supplied to us.

CAL 133

Most Stylex seating can be ordered to meet the requirements of CAL 133. When ordering, simply specify "CAL 133 compliance required". The upcharge for this option is \$54 list per yard. Please refer to the COM yardage of each model to determine the number of yards required. We do frequently require full-scale burn tests in order to certify CAL 133 before an order will be accepted. Such burn tests may increase normal lead times and do carry additional charges. Please contact customer service for details.

CUSTOMER'S OWN MATERIAL/LEATHER

Customer's own material (COM) and customer's own leather (COL) will generally be upholstered at the price designated in each product's price list. Please be advised, however, that we specifically reserve the right to charge a higher price when we determine that special circumstances, such as unusual repeats or challenging materials, present themselves. All orders for custom coverings must be approved by Stylex before they will be accepted for production. To submit proposed textile for approval, please use the COM form [here](#).

Special Note:

We assume no responsibility for the durability or tailoring quality of any COM or COL. Directional covers in particular may not meet your satisfaction due to the design of certain products. Please be advised that COM and COL orders are not subject to return. If you have doubts about the ultimate appearance of certain coverings, please order a sample done with that specific COM or COL. In addition, while we inspect fabrics for mill imperfections, some are difficult to recognize. We cannot be responsible for defects, color inaccuracies, dye lot variations, or other flaws.

Under no circumstances will we be responsible for COM shortages, flaws, or other such problems. Finally, it is not our responsibility to police the receipt of COM's in order to meet delivery deadlines, and we assume our customers are aware of any undue delay in the shipment of their COM fabrics.

COM fabric and COL leather should be sent prepaid to: Stylex

**Attn: COM/COL - [Your PO #]
740 Coopertown Road
Delanco, NJ 08075**

Clearly mark fabric or leather with the dealers name, purchase order number, and furniture model number of the item to be covered. Actual furniture orders should include the same information, as well as a description of the fabric or leather, including pattern and color number, in order to provide a cross reference.

Yardage requirements shown in the price list are based on non-directional goods of 54" width. Fabrics less than 54" wide or those requiring matching (stripes, prints, or large patterned designs) call for additional yardage. We will be happy to supply yardage requirements for large quantities where economies may be realized.

Add the following yardage for stripes, plaids, or patterns with repeats:

Fabric Width	Plain Fabric	2-14" Repeat	15-24" Repeat	25-27" Repeat	28-36" Repeat
54"	0%	10%	15%	20%	25%
50"	10%	20%	25%	30%	35%
48"	15%	25%	30%	35%	40%
45"	40%	50%	55%	60%	65%
36"	50%	60%	65%	70%	75%

COM/COL FORM

To avoid delay in processing COM orders we request that you submit a sample of your COM fabric stapled to this form which can be downloaded [here](#). If a fabric has a stripe or design, the size of the repeat should be indicated. Please indicate the fabric supplier's name, fabric number, and color. Also indicate the Stylex product on which the fabric will be used.

The fabric supplier must indicate on his shipping labels the dealer name and purchase order number as well as the Stylex model number.

Please Note:

No order may be entered into production or have a shipping date assigned until all related COM is received at the factory.



CENTER OF STRIPE OR DESIGN

TOP OF CHAIR	TOP OF CHAIR
--------------	--------------

1. Size of Repeat

2. Fabric Supplier

3. Fabric Number

4. Color

5. Stylex Product

Click

COLORS, MATERIALS, AND FINISHES

MESH BACK & KNIT SEAT



WHITE
(M5)*

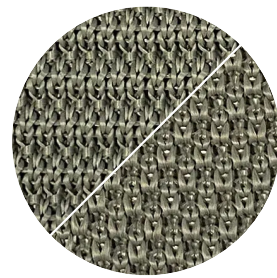

SMOKE
(M3/K3)

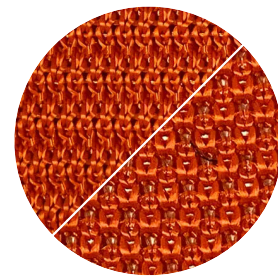

POPPY
(M13/K13)



MIDNIGHT BLUE
(M15/K15)

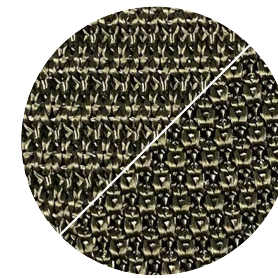

GRAPHITE
(M2/K2)

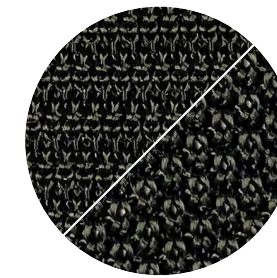

BLACK
(M1/K1)

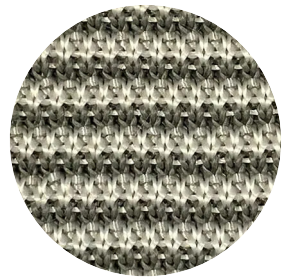

WHITE/SMOKE
(M28)*

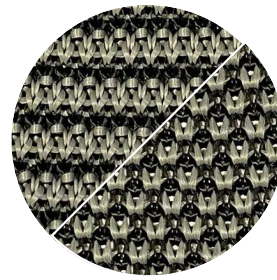

BLACK/SMOKE
(M22/K22)

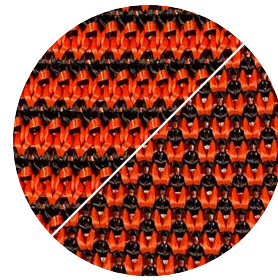

BLACK/RED
(M27/K27)

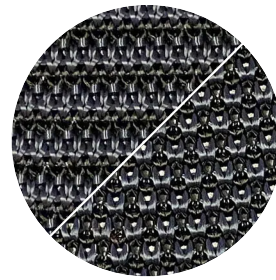

BLACK/MIDNIGHT
BLUE
(M26/K26)

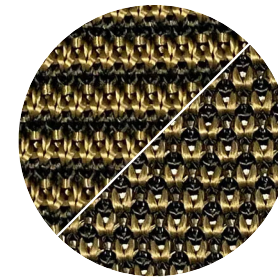

BLACK/BRONZE
(M23/K23)

* NOT OFFERED AS KNIT SEAT

POLYPROPYLENE FRAME

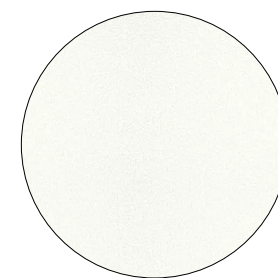

MILK
(02)



LIGHT GRAY
(03)

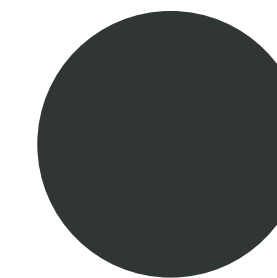

DARK GRAY
(04)

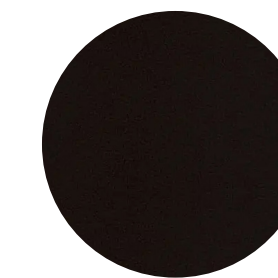

BLACK MATTE
(01)

Click

SPECIFICATION GUIDE: OVERVIEW AND DIMENSIONS

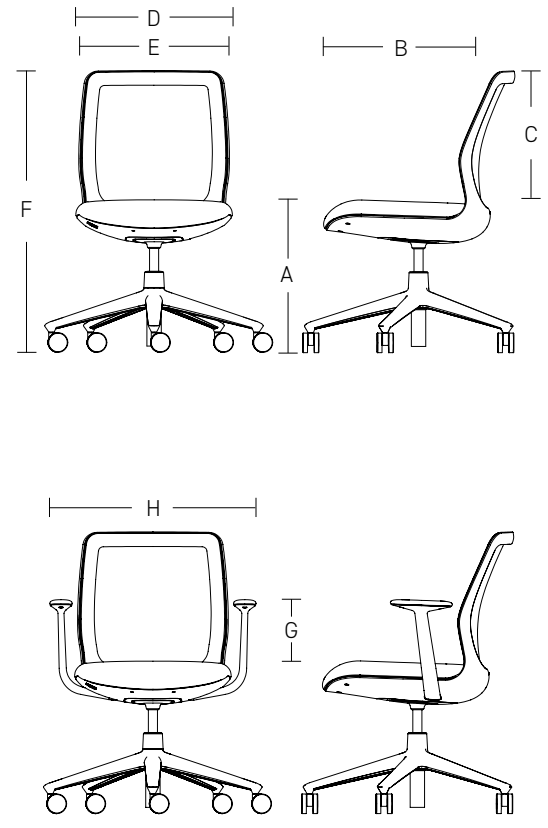
OVERVIEW	CONFERENCE TASK		PRODUCT INFORMATION
<p>Dimensions</p> <ul style="list-style-type: none"> A. Seat Height B. Seat Depth C. Back Height D. Seat Width E. Back Width F. Maximum Overall Height G. Arm Height H. Overall Arm Width 	<p>Armless</p> <ul style="list-style-type: none"> A. 15.25 - 20.25 B. 18.5 C. 18 D. 18.5 E. 17.25 F. 31.5 - 36.5 	<p>Arm</p> <ul style="list-style-type: none"> A. 15.25 - 20.25 B. 18.5 C. 18 D. 18.5 E. 17.25 F. 31.5 - 36.5 G. 8.25 H. 24.5 	<p>PRODUCT INFORMATION</p> <p>Design Mark Kapka/Todd Yetman</p> <p>Seat/Back Construction Frames are injection-molded with mesh backs to which the mesh is applied. Both upholstered and knit seats incorporate a flexible polypropylene seat pan on which is placed a dual-density cushion of molded, CFC-free foam. A height adjustment button is located on the right side of the injection-molded yoke supporting the seat pan. Plastic colors come in black, dark gray, light gray and white. Arm cap colors come in black or light gray.</p> <p>Bases Bases are injection-molded and have five blades. Casters are available in black and gray, both in carpet or soft wheel versions.</p> <p>Testing Manufactured to comply with ANSI/BIFMA X5.1 General Purpose Office Chairs Tests.</p> <p>Environment Greenguard Certified</p> <p>All measurements provided are taken using a BIFMA ISO Chair Measuring Device.</p>

Click

SPECIFICATION GUIDE: HOW TO ORDER

MODEL CODE BREAKDOWN

Sample Model Code: **CL123GBCM01COM**

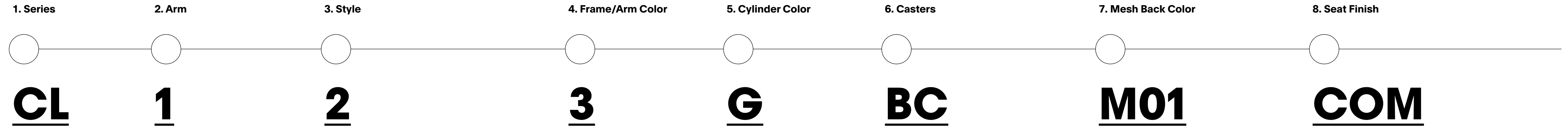

Series
CL CLICK

Arm
1 ARMLESS CHAIR
2 ARM CHAIR

Style
1 KNIT SEAT / MESH BACK
2 UPHOLSTERED SEAT / MESH BACK

Frame Color
1 BLACK
2 MILK
3 LIGHT GRAY
4 DARK GRAY

Arm Cap Color
B BLACK
G LIGHT GRAY

Cylinder Color
B BLACK
G LIGHT GRAY
W WHITE

Casters
BC BLACK CARPET CASTERS
BS BLACK SOFT CASTERS
GC GRAY CARPET CASTERS
GS GRAY SOFT CASTERS

Mesh Back Color
M01 BLACK
M02 GRAPHITE
M03 SMOKE
M05 WHITE
M13 POPPY
M15 MIDNIGHT BLUE
M22 BLACK/SMOKE
M23 BLACK/BRONZE
M26 BLACK/MIDNIGHT BLUE
M27 BLACK/RED
M28 WHITE/SMOKE

Knit Seat Color
K01 BLACK
K02 GRAPHITE
K03 SMOKE
K13 POPPY
K15 MIDNIGHT BLUE
K22 BLACK/SMOKE
K23 BLACK/BRONZE
K26 MIDNIGHT BLUE/BLACK
K27 RED/BLACK

Textile Grades
COM CUSTOMER'S OWN MATERIAL
A GRADE A
B GRADE B
C GRADE C
D GRADE D
E GRADE E
F GRADE F
G GRADE G
H GRADE H
I GRADE I
J GRADE J
K GRADE K
L GRADE L
M GRADE M

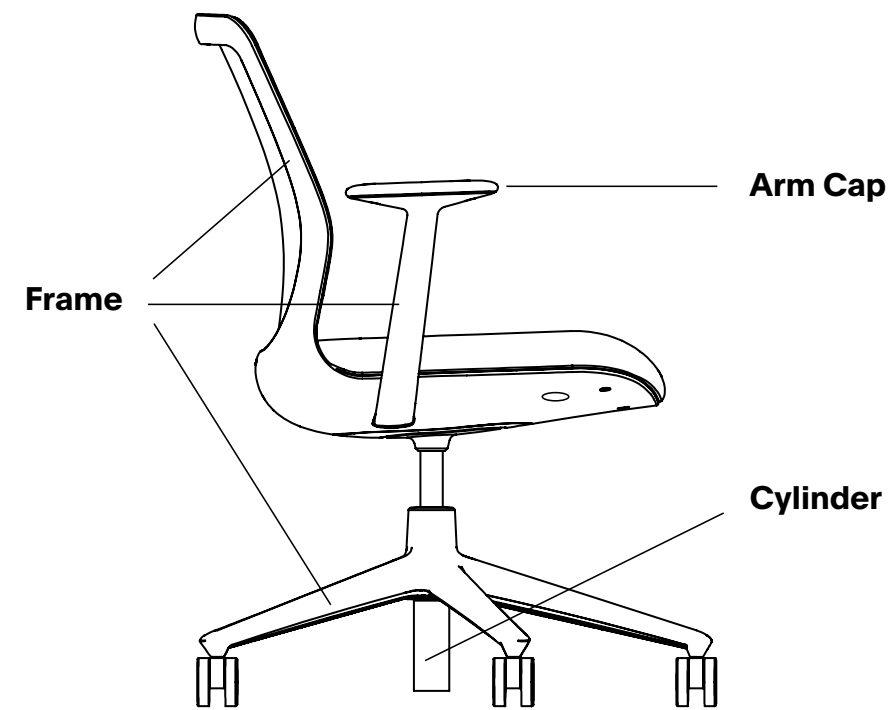

Click

ARMLESS

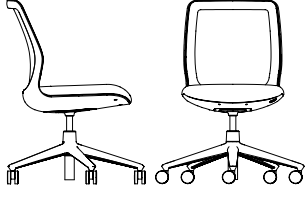
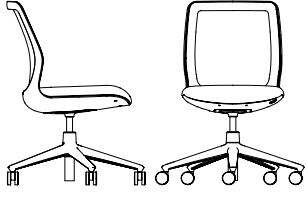
TITLE	SERIES	ARM	STYLE	DIMENSIONS	YDG	Textile Upholstery Grades													
						COM	A	B	C	D	E	F	G	H	I	J	K	L	M
 Armless, Knit Seat, Mesh Back	CL	1	1	18.75W x 29.5D x 31.5 - 36.5H	-	839	-	-	-	-	-	-	-	-	-	-	-	-	-
 Armless, Upholstered Seat, Mesh Back	CL	1	2	18.75W x 29.5D x 31.5 - 36.5H	0.4	813	839	854	868	883	897	914	929	948	972	1,001	1,030	1,058	1,085

To Order Select Below

1. Series/Arm

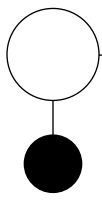

- CL1
- Click Armless**

2. Style

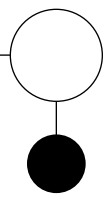

- Style**
- 1 KNIT SEAT / MESH BACK
 - 2 UPHOLSTERED SEAT / MESH BACK

3. Frame

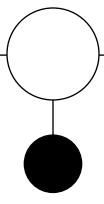

- Frame Color**
- 1 BLACK
 - 2 MILK **+21**
 - 3 LIGHT GRAY **+21**
 - 4 DARK GRAY **+21**

4. Cylinder Color

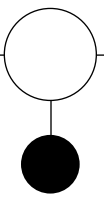

- Cylinder Color**
- B BLACK
 - G LIGHT GRAY
 - W WHITE

5. Casters

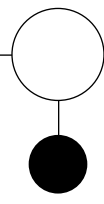

- Casters**
- BC BLACK CARPET CASTERS
 - BS BLACK SOFT CASTERS **+28**
 - GC GRAY CARPET CASTERS **+23**
 - GS GRAY SOFT CASTERS **+39**

6. Mesh Back Color

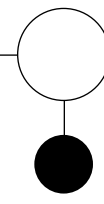

- Mesh Back Color**
- M01 BLACK
 - M02 GRAPHITE
 - M03 SMOKE
 - M05 WHITE
 - M13 POPPY
 - M15 MIDNIGHT BLUE
 - M22 BLACK/SMOKE
 - M23 BLACK/BRONZE
 - M26 BLACK/MIDNIGHT BLUE
 - M27 BLACK/RED
 - M28 WHITE/SMOKE

7. Seat Choice

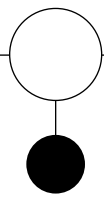

- Knit Seat Color**
- K01 BLACK
 - K02 GRAPHITE
 - K03 SMOKE
 - K13 POPPY
 - K15 MIDNIGHT BLUE
 - K22 BLACK/SMOKE
 - K23 BLACK/BRONZE
 - K26 BLACK/MIDNIGHT BLUE
 - K27 BLACK/RED

Upholstery
 See [general information section](#) for details on textile program and COM/COL information.

Click

ARM

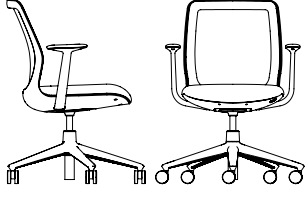
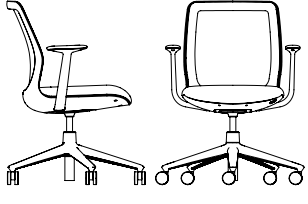
TITLE	SERIES	ARM	STYLE	DIMENSIONS	YDG	Textile Upholstery Grades													
						COM	A	B	C	D	E	F	G	H	I	J	K	L	M
 Arm, Knit Seat, Mesh Back	CL	2	1	24.5W x 29.5D x 31.5 - 36.5H	-	899	-	-	-	-	-	-	-	-	-	-	-	-	-
 Arm, Upholstered Seat, Mesh Back	CL	2	2	24.5W x 29.5D x 31.5 - 36.5H	0.4	873	899	914	928	943	957	973	989	1,008	1,032	1,061	1,090	1,118	1,145

To Order Select Below

1. Series/Arm

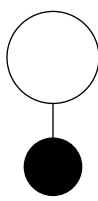

CL2

Click Arm

2. Style

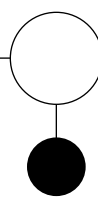

Style

- 1 KNIT SEAT / MESH BACK
- 2 UPHOLSTERED SEAT / MESH BACK

3. Frame/Arm Color

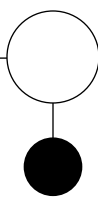

Frame Color

- 1 BLACK
- 2 MILK **+23**
- 3 LIGHT GRAY **+23**
- 4 DARK GRAY **+23**

Arm Cap Color

- B BLACK
- G LIGHT GRAY

4. Cylinder Color

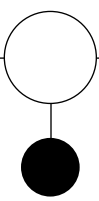

Cylinder Color

- B BLACK
- G LIGHT GRAY
- W WHITE

5. Casters

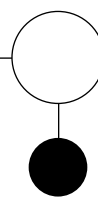

Casters

- BC BLACK CARPET CASTERS
- BS BLACK SOFT CASTERS **+28**
- GC GRAY CARPET CASTERS **+23**
- GS GRAY SOFT CASTERS **+39**

6. Mesh Back Color

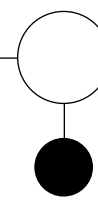

Mesh Back Color

- M01 BLACK
- M02 GRAPHITE
- M03 SMOKE
- M05 WHITE
- M13 POPPY
- M15 MIDNIGHT BLUE
- M22 BLACK/SMOKE
- M23 BLACK/BRONZE
- M26 BLACK/MIDNIGHT BLUE
- M27 BLACK/RED
- M28 WHITE/SMOKE

7. Seat Choice

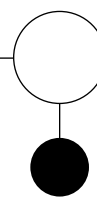

Knit Seat Color

- K01 BLACK
- K02 GRAPHITE
- K03 SMOKE
- K13 POPPY
- K15 MIDNIGHT BLUE
- K22 BLACK/SMOKE
- K23 BLACK/BRONZE
- K26 BLACK/MIDNIGHT BLUE
- K27 BLACK/RED

Upholstery

See [general information section](#) for details on textile program and COM/COL information.

stylex

Cove Lounge

PRICE LIST

Effective November 01, 2023

General Information

GENERAL INFORMATION

Terms

Net 30 days from date of invoice,
F. O. B . Delanco, New Jersey.

Damaged Shipments

All Stylex products are carefully inspected before they are packed in sturdy cartons designed to satisfy shipping requirements. Stylex is not responsible for damage in shipment. The transportation company assumes responsibility for delivering products to you in good condition when the bill of lading is signed. You protect yourself by refusing shipments showing damage or shortage until transportation company has noted on the delivery sheet the extent of damage or shortage. Concealed damage should be reported to the carrier as soon as discovered, but not later than 15 days after receiving shipment.

Return/Restocking Policy

Return shipments will not be accepted unless specifically authorized by Stylex in writing. The Return Authorization number should be clearly marked on the carton. The customer returning Stylex products is responsible for return shipping costs. Merchandise must be returned unused. Returned merchandise is subject to a 35% restocking fee.

Custom Products

Modifications to standard products will be considered for large runs. Contact factory for price quotations.

Design Changes

In keeping with modern manufacturing advances, Stylex reserves the right to incorporate minor modifications and design changes in products without notice.

Cancellation Policy

No charge prior to production except for inventory specifically requisitioned to fulfill the particular order. After production has begun, only actual costs incurred, including labor and material, will be billed to the customer.

WARRANTY

Except as provided below, Stylex warrants exclusively to the original Purchaser of our product that all parts, under normal use and service, will be free from defects in workmanship and material for a period of ten (10) years from the date of purchase. "Normal use and service" means that the product will be used in a typical office environment for 40-45 hours per week.

This warranty is subject to the following limitations, exclusions and provisions:

Limitations involving materials and components:

Wood components of plywood stacking chairs
(such as Brooks and Welcome)
5 years

Upholstery

(including mesh used for Click, F4, Insight, and Zephyr Mesh)
3 years

SAVA Mesh

10 years

COM Upholstery

No warranty
Stylex makes every effort to ensure that the COM Upholstery it approves is suitable for the intended use. Nevertheless, we will not warrant, and assume no responsibility for, the durability or tailoring quality of any COM or COL. If you have any concerns about the ultimate appearance of any covering, please order an upholstered sample.

Painted Stack Chair Frames

No Warranty

We will not warrant the finish of painted stack chair frames against damage from stacking. Please order chrome frames for chairs that will be stacked.

Felt Glides

No warranty

Due to the different surfaces on which felt glides may be used, we cannot warrant their durability over time.

If this product fails during normal use and service within the applicable warranty period (other than through normal wear and tear), please send a description of the relevant part and the nature of the defect, together with proof of purchase of the product, to Stylex at: Customer Service. c/o Stylex, P.O. Box 5038, Delanco, NJ 08075. PLEASE DO NOT RETURN PARTS OR THE PRODUCT TO STYLEX UNLESS INSTRUCTED TO DO SO BY STYLEX. Stylex will, at its option, either repair or replace the product or the part found defective by Stylex completely without charge for materials or labor. Purchaser may be required (at the option of Stylex) to return to Stylex at Purchaser's expense any defective part with all freight or shipping charges prepaid. The foregoing warranty shall be void if the product has been altered or repaired (other than by Stylex). The warranty does not cover damage to the product caused by accident, neglect, misuse, abuse, modification to the product by anyone other than Stylex or damage caused by use of the product for a purpose other than that for which it was designed. This warranty extends only to the original Purchaser of the product.

No Other Warranties

This warranty is in lieu of all other warranties, expressed or implied, including, but not limited to, implied warranties of merchantability and fitness for a particular purpose. The rights and remedies provided herein are the exclusive rights and remedies of the original purchaser of the product.

No Liability For Damages

In no event shall Stylex or its suppliers be responsible or liable for any special, indirect, consequential, or incidental damages. In no event shall the liability of Stylex exceed the actual purchase price paid to Stylex for the product.

Out of Warranty Products

For all products no longer covered by our warranty, please refer to our Design for Durability and Upgradability Policy. Contact Customer Service if you would like to purchase any replaceable components to further extend the life of any Stylex seating product. This warranty applies to all Stylex products purchased on April 13, 2018, and thereafter.

PRODUCT TAKE BACK PROGRAM

In order to be good stewards of our products, Stylex offers a pathway towards a Product Take Back Program as a more viable solution to the end of our products' originally intended life.

Stylex supports the sustainable programs of ANEW and offers their added value to our clients through a comprehensive take-back solution for surplus office furniture and materials of any kind, in any condition. ANEW is a 501(c)(3) non-profit organization that exists to provide companies with smart, cost effective alternatives for their surplus furniture and other items with the priority of matching it to non-profits, public agencies and the underserved, within the local community of the project site. Corporate Social Responsibility is raised while the impact on the environment is lowered by diverting products and materials otherwise destined for landfill.

Stylex is proud to offer ANEW to customers dedicated to strengthening their community network by repurposing their furniture, fixtures and architectural materials to those in need. In 2014, Stylex committed to making this relationship a part of our strategic sales strategy. Visit www.anewfound.org to find out more.

To initiate a Product Take Back strategy through ANEW, contact Stylex Customer Service at 800-257-5742.

For other end of life recovery options, please see our Product Disassembly Instructions and End of Life Recovery Options documents available on our website in the resources section of each product in our line.

FREIGHT PROGRAM

Stylex offers a Guaranteed Freight Program, which provides the purchaser the ability to determine shipping and handling charges at the time of order. Freight charges will be calculated as a percentage of the net product price and added to the invoice at the time of shipment. The continental United States has been divided into three zones. Please use the map below to determine the freight charges for the product's destination. There is a minimum freight charge of \$150.

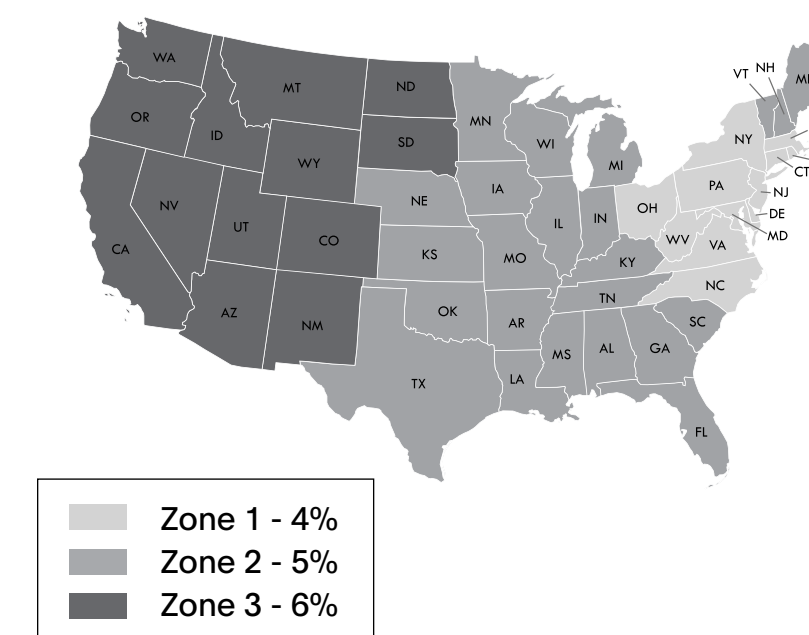

ZONE 1 - 4%

Connecticut
Delaware
New York
New Jersey
Maryland
Massachusetts
North Carolina
Ohio
Pennsylvania
Rhode Island
Virginia
Washington D.C.
West Virginia

ZONE 2 - 5%

Alabama
Arkansas
Canada, Ontario
Canada, Quebec
Florida
Georgia
Iowa
Illinois
Indiana
Kansas
Kentucky
Louisiana
Nebraska
New Hampshire
Oklahoma
Maine
Michigan
Minnesota
Missouri
Mississippi
South Carolina
Tennessee
Texas
Vermont
Wisconsin

ZONE 3 - 6%

Arizona
California
Colorado
Idaho
Montana
Nevada
New Mexico
North Dakota
Oregon
South Dakota
Utah
Washington
Wyoming

Quote Per Project
Alaska
Hawaii
Canada
(outside Ontario & Quebec)
Mexico

General Information

TEXTILE PARTNERS & APPROVALS

Textile Partners

To customize your furniture performance needs and design vision, Stylex offers a wide selection of in-graded leathers and textiles from Grades A through Y. We've partnered with leading manufacturers on the options, focusing on color, price, durability, and construction. To view our partners and explore our digital carded program with broadly approved textiles, visit [this page](#). We stand by these textiles: They're tried and tested, and will effortlessly fit into any design aesthetic.

Textile Approvals

To view Stylex Approved Textile documents to determine specific product approval status, visit [this page](#).

CAL 117 AND 133 COMPLIANCE

CAL 117-2013

All Stylex seating satisfies the requirements of CAL 117-2013 so long as one of our standard or in-graded fabrics is applied. COM textiles cannot be so guaranteed. Please contact the supplier of COM's directly to determine the fire retardancy of any COM supplied to us.

CAL 133

Most Stylex seating can be ordered to meet the requirements of CAL 133. When ordering, simply specify "CAL 133 compliance required". The upcharge for this option is \$54 list per yard. Please refer to the COM yardage of each model to determine the number of yards required. We do frequently require full-scale burn tests in order to certify CAL 133 before an order will be accepted. Such burn tests may increase normal lead times and do carry additional charges. Please contact customer service for details.

CUSTOMER'S OWN MATERIAL/LEATHER

Customer's own material (COM) and customer's own leather (COL) will generally be upholstered at the price designated in each product's price list. Please be advised, however, that we specifically reserve the right to charge a higher price when we determine that special circumstances, such as unusual repeats or challenging materials, present themselves. All orders for custom coverings must be approved by Stylex before they will be accepted for production. To submit proposed textile for approval, please use the COM form [here](#).

Special Note:

We assume no responsibility for the durability or tailoring quality of any COM or COL. Directional covers in particular may not meet your satisfaction due to the design of certain products. Please be advised that COM and COL orders are not subject to return. If you have doubts about the ultimate appearance of certain coverings, please order a sample done with that specific COM or COL. In addition, while we inspect fabrics for mill imperfections, some are difficult to recognize. We cannot be responsible for defects, color inaccuracies, dye lot variations, or other flaws.

Under no circumstances will we be responsible for COM shortages, flaws, or other such problems. Finally, it is not our responsibility to police the receipt of COM's in order to meet delivery deadlines, and we assume our customers are aware of any undue delay in the shipment of their COM fabrics.

COM fabric and COL leather should be sent prepaid to: Stylex

**Attn: COM/COL - [Your PO #]
740 Coopertown Road
Delanco, NJ 08075**

Clearly mark fabric or leather with the dealers name, purchase order number, and furniture model number of the item to be covered. Actual furniture orders should include the same information, as well as a description of the fabric or leather, including pattern and color number, in order to provide a cross reference.

Yardage requirements shown in the price list are based on non-directional goods of 54" width. Fabrics less than 54" wide or those requiring matching (stripes, prints, or large patterned designs) call for additional yardage. We will be happy to supply yardage requirements for large quantities where economies may be realized.

Add the following yardage for stripes, plaids, or patterns with repeats:

Fabric Width	Plain Fabric	2-14" Repeat	15-24" Repeat	25-27" Repeat	28-36" Repeat
54"	0%	10%	15%	20%	25%
50"	10%	20%	25%	30%	35%
48"	15%	25%	30%	35%	40%
45"	40%	50%	55%	60%	65%
36"	50%	60%	65%	70%	75%

COM/COL FORM

To avoid delay in processing COM orders we request that you submit a sample of your COM fabric stapled to this form which can be downloaded [here](#). If a fabric has a stripe or design, the size of the repeat should be indicated. Please indicate the fabric supplier's name, fabric number, and color. Also indicate the Stylex product on which the fabric will be used.

The fabric supplier must indicate on his shipping labels the dealer name and purchase order number as well as the Stylex model number.

Please Note:

No order may be entered into production or have a shipping date assigned until all related COM is received at the factory.



CENTER OF STRIPE OR DESIGN

TOP OF CHAIR	TOP OF CHAIR
--------------	--------------

1. Size of Repeat

2. Fabric Supplier

3. Fabric Number

4. Color

5. Stylex Product

Cove Lounge

Contents

<hr/>		<hr/>	
COLORS, MATERIALS, AND FINISHES	5	CHAIR: FOUR-BLADE ALUMINUM BASE	9
<hr/>		<hr/>	
STATEMENT OF LINE	6	CHAIR: FOUR-BLADE WOOD CAPPED BASE	10
<hr/>		<hr/>	
DIMENSIONS	7	CHAIR: SLED BASE	11
<hr/>		<hr/>	
HOW TO ORDER	8	CHAIR: WOOD LEG	12
<hr/>		<hr/>	
		OTTOMAN	13
		<hr/>	

CLICK THE TITLES ABOVE TO NAVIGATE THROUGH THE DOCUMENT
PRODUCT HEADERS ON SUBSEQUENT PAGES LINK BACK TO THIS PAGE

Cove Lounge

COLORS, MATERIALS, AND FINISHES

POWDER PAINT FRAME FINISHES

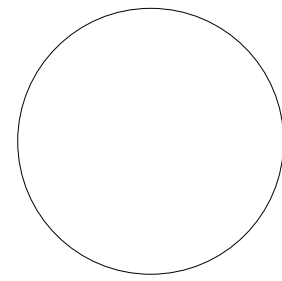

MILK
(MK)

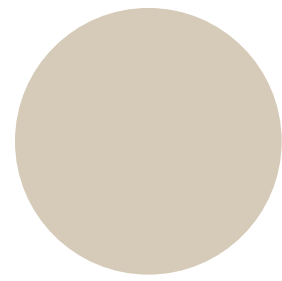

SAND
(SD)

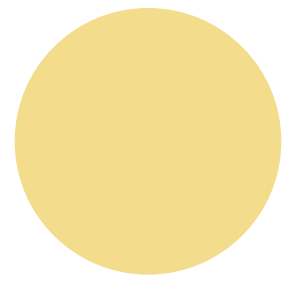

PALE YELLOW
(PY)

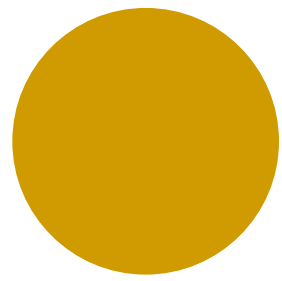

YELLOW
(YL)

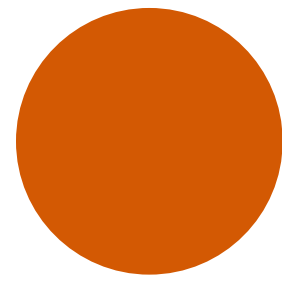

ORANGE
(OR)

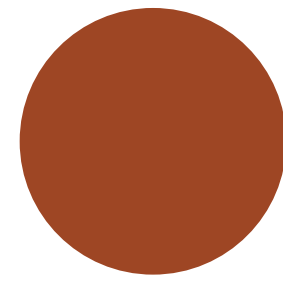

TERRACOTTA
(TC)

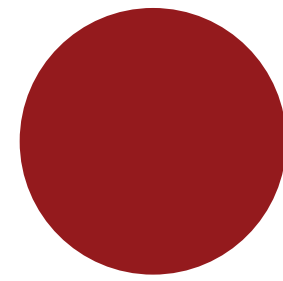

RED
(RD)

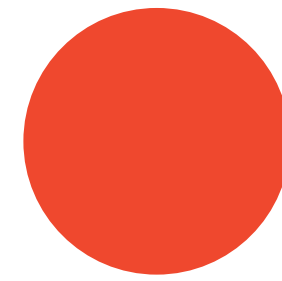

RED ORANGE
(RO)

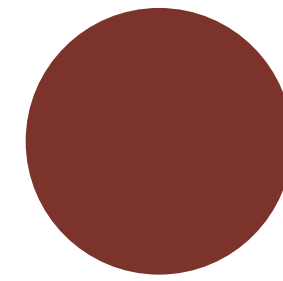

RUSTY RED
(RR)

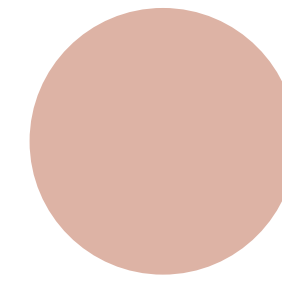

DUSTY PINK
(DP)

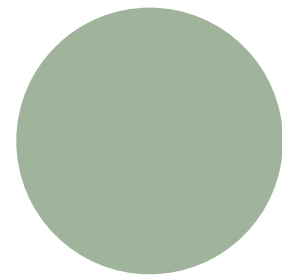

MEADOW GREEN
(MG)

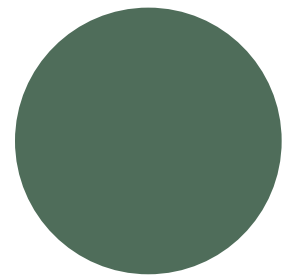

FOREST GREEN
(FG)

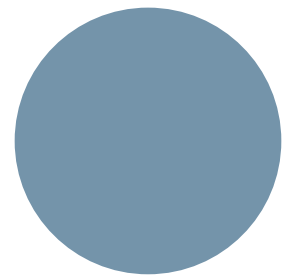

SOFT BLUE
(SB)

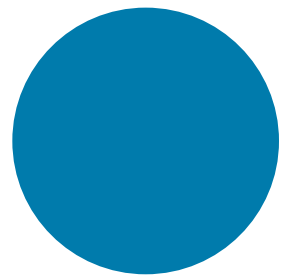

BLUE
(BL)

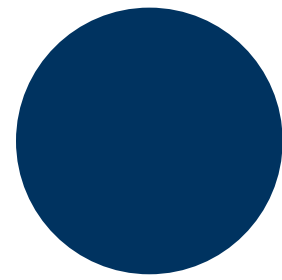

NAVY
(NV)

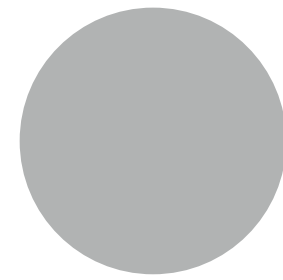

LIGHT GRAY
(LG)



CHAMPAGNE
(CP)

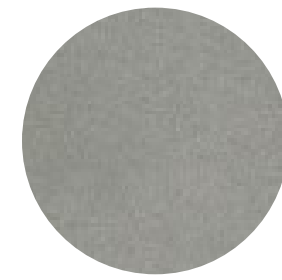

METALLIC SILVER
(MS)

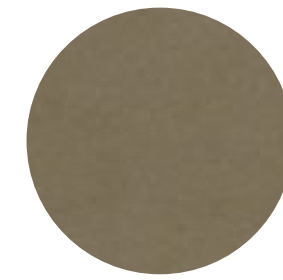

NICKEL
(NK)

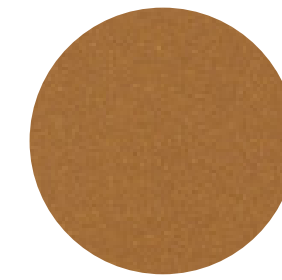

BRASS
(BR)

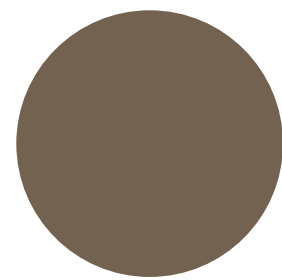

TAUPE
(TP)



DARK BRONZE
(DB)

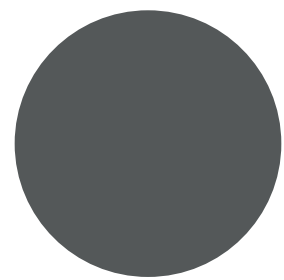

DARK GRAY
(DG)



TEXTURED SLATE
(TS)

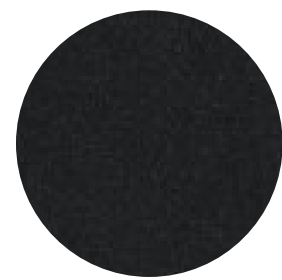

BLACK TWILIGHT
(BT)

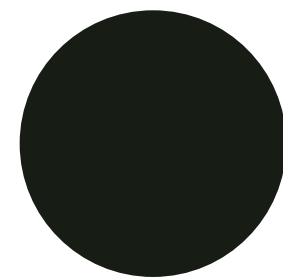

BLACK MATTE
(BM)

POLISHED METAL FRAME FINISH

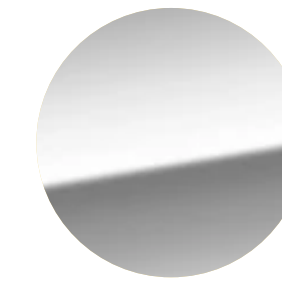

POLISHED AL
(AL)

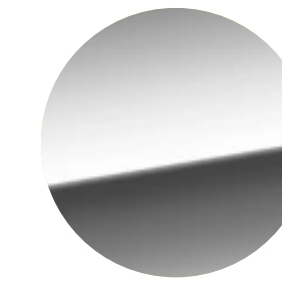

BRIGHT CHROME
(CH)

WOOD LEG FINISH



NATURAL MAPLE
(83)



WHITE OAK
(81)



WALNUT
(85)

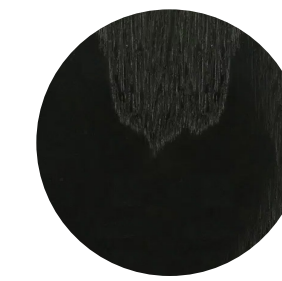

OPAQUE BLACK
(87)

Cove Lounge

SPECIFICATION GUIDE: STATEMENT OF LINE

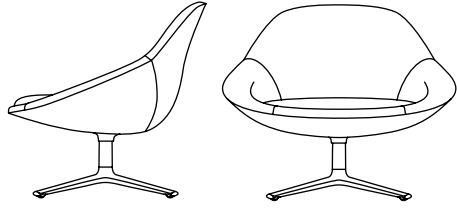
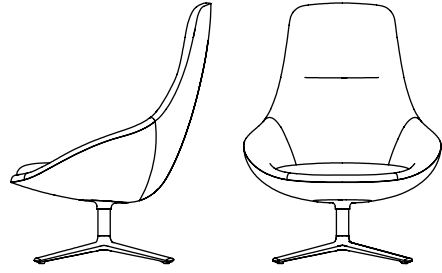
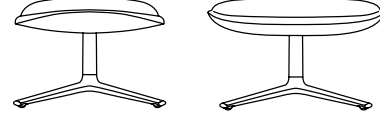
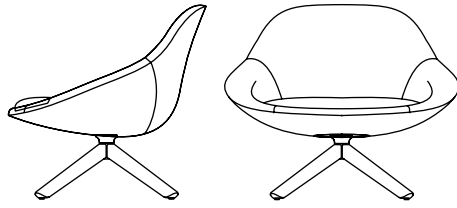
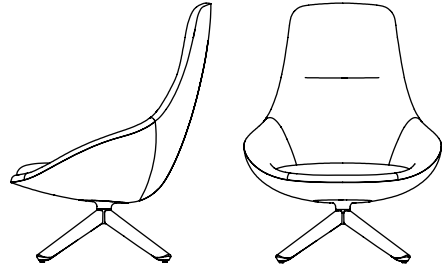
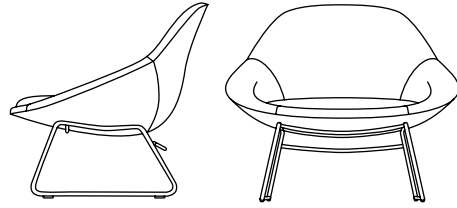
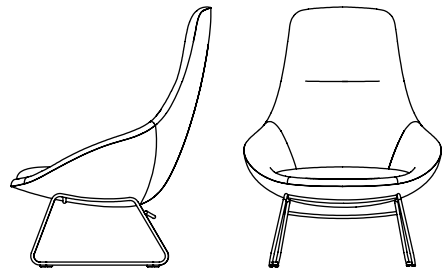
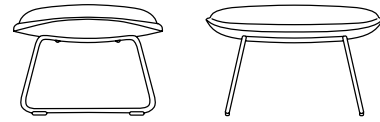
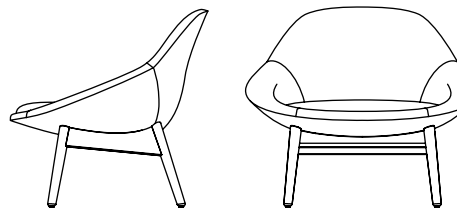
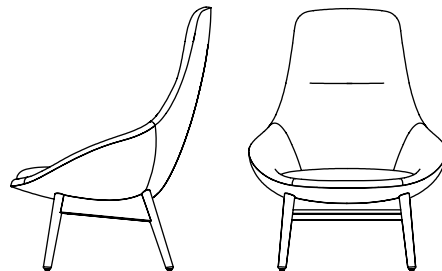
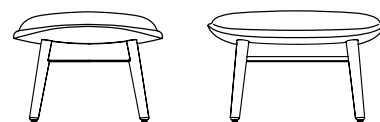
OVERVIEW	LOUNGE	HIGH BACK	OTTOMAN
Four-Blade Aluminum Base Fixed-Height Swivel Fixed-Height Swivel Return Fixed-Height No Swivel			
Four-Blade Wood Capped Base Fixed-Height Swivel Fixed-Height No Swivel			
Sled Base			
Wood Leg			

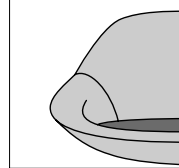
OPTIONS		
Upholstery and Accessories	Contrasting Thread	Dual Upholstered Seat and Shell
		

PRODUCT INFORMATION

Design
Stylex/Brandon Walker

Construction - Chairs
The lounge and high back chairs consist of a rigid, plant-based polyurethane structure, overlaid with soft, molded foam.

Construction - Ottoman
The ottoman consists of a rigid, plant-based polyurethane shell and bent plywood seat, overlaid with soft, molded foam.

Construction - Bases
Sled frames consist of 1/2" diameter steel rod and can be ordered in bright chrome or powder coat. Four-Blade bases are cast aluminum and can be polished or powder coated. Four-Blade wood capped bases consist of wood legs attached to a powder coated steel frame.

Use
Designed for indoor use only.

Performance Standards
Manufactured to comply with:
ANSI/BIFMA X5.4 Lounge Seating Tests

Certifications
GREENGUARD Gold
LEVEL® 1

Cove Lounge

SPECIFICATION GUIDE: DIMENSIONS

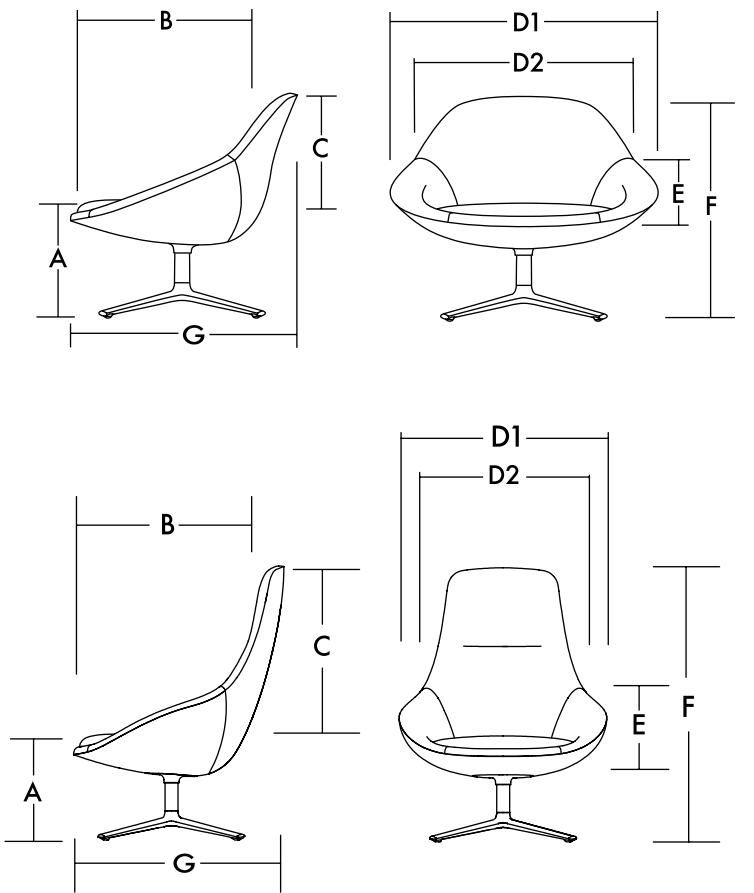
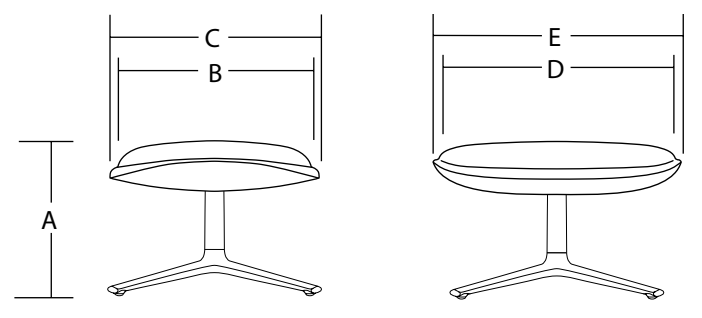
OVERVIEW	LOUNGE				HIGH BACK			
<p>Dimensions</p> <ul style="list-style-type: none"> A. Seat Height B. Seat Depth C. Back Height D1. Armless Overall Width D2. Seat Width E. Arm Height F. Maximum Overall Height G. Overall Depth 	<p>Four-Blade Aluminum</p> <ul style="list-style-type: none"> A. 16" B. 20.5" C. 18" D1. 36" D2. 25" E. 7" F. 30" G. 30.5" 	<p>Four-Blade Wood Capped</p> <ul style="list-style-type: none"> A. 16" B. 20.5" C. 18" D1. 36" D2. 25" E. 7" F. 30" G. 30.5" 	<p>Sled</p> <ul style="list-style-type: none"> A. 16" B. 20.5" C. 18" D1. 36" D2. 25" E. 7" F. 30" G. 30.5" 	<p>Wood Leg</p> <ul style="list-style-type: none"> A. 16" B. 20.5" C. 18" D1. 36" D2. 25" E. 7" F. 30" G. 30.5" 	<p>Four-Blade Aluminum</p> <ul style="list-style-type: none"> A. 16" B. 20.5" C. 30" D1. 32" D2. 22.5" E. 8" F. 42" G. 32.5" 	<p>Four-Blade Wood Capped</p> <ul style="list-style-type: none"> A. 16" B. 20.5" C. 30" D1. 32" D2. 22.5" E. 8" F. 42" G. 32.5" 	<p>Sled</p> <ul style="list-style-type: none"> A. 16" B. 20.5" C. 30" D1. 32" D2. 22.5" E. 8" F. 42" G. 32.5" 	<p>Wood Leg</p> <ul style="list-style-type: none"> A. 16" B. 20.5" C. 30" D1. 32" D2. 22.5" E. 8" F. 42" G. 32.5"
<p>Ottoman</p> <ul style="list-style-type: none"> A. Seat Height B. Seat Depth C. Overall Depth D. Seat Width E. Overall Width 	<p>Four-Blade Aluminum</p> <ul style="list-style-type: none"> A. 15.5" B. 18.75" C. 20.5" D. 23.375" E. 24.5" 	<p>Sled</p> <ul style="list-style-type: none"> A. 15.5" B. 18.75" C. 20.5" D. 23.375" E. 24.5" 	<p>Wood Leg</p> <ul style="list-style-type: none"> A. 15.5" B. 18.75" C. 20.5" D. 23.375" E. 24.5" 					

Cove Lounge

SPECIFICATION GUIDE: HOW TO ORDER

MODEL CODE BREAKDOWN

Sample Model Code: CV470DF1CT81BLCOM

1. Series

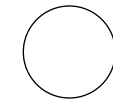

CV

Series
CV – COVE LOUNGE

2. Style/Base

470

Choose style/base.

Frame/Base
470 – LOUNGE CHAIR, FOUR-BLADE CAST ALUMINUM BASE, FIXED-HEIGHT SWIVEL
472 – LOUNGE CHAIR, FOUR-BLADE CAST ALUMINUM BASE, FIXED-HEIGHT 360° SWIVEL RETURN
471 – LOUNGE CHAIR, FOUR-BLADE CAST ALUMINUM BASE, FIXED-HEIGHT NO SWIVEL
450 – LOUNGE CHAIR, WOOD CAPPED BASE, FIXED-HEIGHT SWIVEL
452 – LOUNGE CHAIR, WOOD CAPPED BASE, FIXED-HEIGHT NO SWIVEL
410 – LOUNGE CHAIR, SLED BASE
460 – LOUNGE CHAIR, WOOD LEG
370 – HIGH BACK CHAIR, FOUR-BLADE CAST ALUMINUM BASE, FIXED-HEIGHT SWIVEL
372 – HIGH BACK CHAIR, FOUR-BLADE CAST ALUMINUM BASE, FIXED-HEIGHT 360° SWIVEL RETURN
371 – HIGH BACK CHAIR, FOUR-BLADE CAST ALUMINUM BASE, FIXED-HEIGHT NO SWIVEL
350 – HIGH BACK CHAIR, WOOD CAPPED BASE, FIXED-HEIGHT SWIVEL
352 – HIGH BACK CHAIR, WOOD CAPPED BASE, FIXED-HEIGHT NO SWIVEL
310 – HIGH BACK CHAIR, SLED BASE
360 – HIGH BACK CHAIR, WOOD LEG
572 – OTTOMAN, FOUR-BLADE CAST ALUMINUM BASE, FIXED-HEIGHT NO SWIVEL
510 – OTTOMAN, SLED BASE
560 – OTTOMAN, WOOD LEG

3. Dual Upholstery

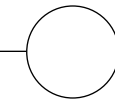

DF1

Choose dual upholstery.

Dual Upholstery
DF1 – DUAL UPHOLSTERY

4. Options

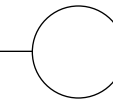

CT

Choose options.

Options
CT – CONTRASTING THREAD

5. Wood Finish

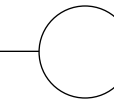

81

Choose wood finish.

Wood Finish
81 – NATURAL MAPLE
83 – WHITE OAK
85 – WALNUT
87 – OPAQUE BLACK

6. Frame Finish

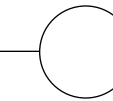

BL

Choose frame finish.

Frame Finish
Standard Powder Paint
BL – BLUE
BM – BLACK MATTE
BR – BRASS
BT – BLACK TWILIGHT
CP – CHAMPAGNE
DB – DARK BRONZE
DG – DARK GRAY
DP – DUSTY PINK
FG – FOREST GREEN
LG – LIGHT GRAY
MG – MEADOW GREEN
MK – MILK
MS – METALLIC SILVER
NK – NICKEL
NV – NAVY
OR – ORANGE
PY – PALE YELLOW
RD – RED
RO – RED ORANGE
RR – RUSTY RED
SB – SOFT BLUE
SD – SAND
TC – TERRACOTTA
TP – TAUPE
TS – TEXTURED SLATE
YL – YELLOW

Polished Metal
AL – POLISHED ALUMINUM
CH – BRIGHT CHROME (SLED BASE ONLY)

7. Upholstery

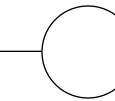

COM

Choose upholstery grade,
highest grade in the case of
dual upholstery option.

Upholstery
Textile Grades
COM – CUSTOMER'S OWN MATERIAL
A – GRADE A
B – GRADE B
C – GRADE C
D – GRADE D
E – GRADE E
F – GRADE F
G – GRADE G
H – GRADE H
I – GRADE I
J – GRADE J
K – GRADE K

Leather Grades
COL – CUSTOMER'S OWN LEATHER
W – GRADE W
X – GRADE X
Y – GRADE Y
E1 – GRADE E1
E2 – GRADE E2

Cove Lounge

CHAIR: FOUR-BLADE ALUMINUM BASE

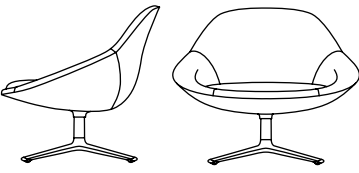
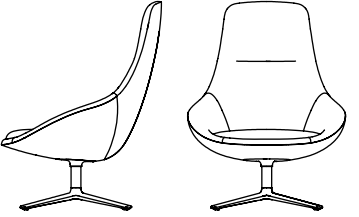
	SERIES	STYLE	COM	COL	Textile Upholstery Grades												Leather Upholstery Grades						
					COM	A	B	C	D	E	F	G	H	I	J	K	W	X	Y	E1	E2		
Lounge Chair Four-Blade Aluminum Base 		Fixed-Height Swivel	CV	470	2.8	41	2,370	2,576	2,688	2,793	2,906	3,018	3,141	3,261	3,404	3,592	3,814	4,037	3,568	3,879	4,885	5,304	6,437
		Fixed-Height 360° Swivel Return	CV	471	2.8	41	2,442	2,648	2,758	2,865	2,979	3,088	3,210	3,333	3,477	3,662	3,885	4,109	3,640	3,950	4,957	5,375	6,508
		Fixed-Height No Swivel	CV	472	2.8	41	2,370	2,576	2,688	2,793	2,906	3,018	3,141	3,261	3,404	3,592	3,814	4,037	3,568	3,879	4,885	5,304	6,437
High Back Chair Four Blade Aluminum Base 		Fixed-Height Swivel	CV	370	3.0	47	2,807	3,001	3,106	3,209	3,315	3,421	3,537	3,652	3,788	3,964	4,176	4,385	3,723	4,044	5,062	5,713	6,359
		Fixed-Height 360° Swivel Return	CV	371	3.0	47	2,883	3,078	3,184	3,287	3,392	3,499	3,614	3,729	3,866	4,040	4,253	4,463	3,800	4,121	5,140	5,790	6,435
		Fixed-Height No Swivel	CV	372	3.0	47	2,807	3,001	3,106	3,209	3,315	3,421	3,537	3,652	3,788	3,964	4,176	4,385	3,723	4,044	5,062	5,713	6,359

To Order Select Below

1. Series

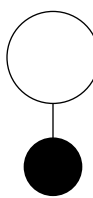

CV

Cove Lounge

2. Style/Base

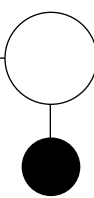

Lounge

470	LOUNGE CHAIR, CAST ALUMINUM BASE, FIXED-HEIGHT SWIVEL
471	LOUNGE CHAIR, CAST ALUMINUM BASE, FIXED-HEIGHT 360° SWIVEL RETURN
472	LOUNGE CHAIR, CAST ALUMINUM BASE, FIXED-HEIGHT NO SWIVEL

High Back

370	HIGH BACK CHAIR, CAST ALUMINUM BASE, FIXED-HEIGHT SWIVEL
371	HIGH BACK CHAIR, CAST ALUMINUM BASE, FIXED-HEIGHT 360° SWIVEL RETURN
372	HIGH BACK CHAIR, CAST ALUMINUM BASE, FIXED-HEIGHT NO SWIVEL

3. Dual Upholstery Option

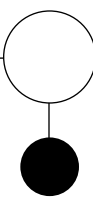

Dual Upholstery Option

DF1 DUAL UPHOLSTERY

Dual Upholstery allows for different fabrics on the seat and shell. When specifying In-Graded fabrics, please apply the higher of the two grades. Fabric and Leather combinations are only available as COM/COL orders. Fabric and Leather combinations are only available as COM/COL orders.

Textile (yd) and leather (sqft) quantities for dual upholstery are the following:

Lounge Chair
 Seat: 1 yd / 9 sqft
 Shell: 2 yd / 31 sqft

High Back Chair
 Seat: 1.1 yd / 9 sqft
 Shell: 2.8 yd / 37 sqft

4. Options

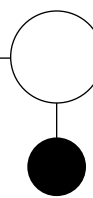

Options

CT CONTRASTING THREAD

5. Frame Finish

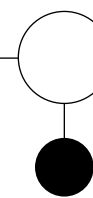

Standard Powder Coated Metal

BL	BLUE	NK	NICKEL
BM	BLACK MATTE	NV	NAVY
BR	BRASS	OR	ORANGE
BT	BLACK TWILIGHT	PY	PALE YELLOW
CP	CHAMPAGNE	RD	RED
DB	DARK BRONZE	RO	RED ORANGE
DG	DARK GRAY	RR	RUSTY RED
DP	DUSTY PINK	SB	SOFT BLUE
FG	FOREST GREEN	SD	SAND
LG	LIGHT GRAY	TC	TERRACOTTA
MG	MEADOW GREEN	TP	TAUPE
MK	MILK	TS	TEXTURED SLATE
MS	METALLIC SILVER	YL	YELLOW

Polished Aluminum

AL POLISHED ALUMINUM

6. Upholstery

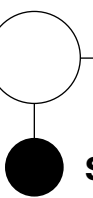

See general information section for details on textile program and COM/COL information.

Cove Textile Precautions
 Fabrics are cut railroad. Certain horizontal stripes, plaids, or fabrics with very little stretch are not acceptable for use on this product.

All textiles and leathers must be pre-approved for this product. Cove may develop mild comfort wrinkles on the inside back and seat when specified with leather or fabrics that do not recover well.

Cove Lounge

CHAIR: FOUR-BLADE WOOD CAPPED BASE

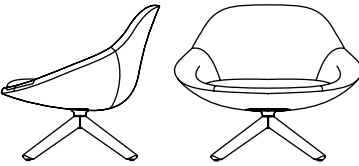
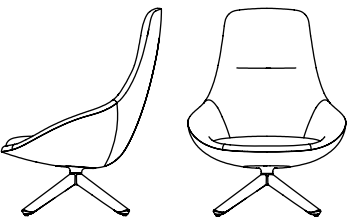
	SERIES	STYLE	COM	COL	Textile Upholstery Grades												Leather Upholstery Grades					
					YDG	SQ FT	COM	A	B	C	D	E	F	G	H	I	J	K	W	X	Y	E1
Lounge Chair Four-Blade Wood Capped Base 	CV	Fixed-Height Swivel	450	2.8	41	3,169	3,365	3,472	3,575	3,683	3,789	3,906	4,024	4,161	4,339	4,552	4,765	4,318	4,617	5,580	5,981	7,070
		Fixed-Height No Swivel	452	2.8	41	3,030	3,228	3,334	3,439	3,545	3,651	3,768	3,884	4,024	4,201	4,414	4,627	4,178	4,479	5,441	5,843	6,931
High Back Chair Four-Blade Wood Capped Base 	CV	Fixed-Height Swivel	350	3.0	47	3,511	3,704	3,810	3,913	4,019	4,125	4,241	4,355	4,493	4,667	4,879	5,089	4,427	4,748	5,767	6,418	7,062
		Fixed-Height No Swivel	352	3.0	47	3,369	3,563	3,669	3,772	3,878	3,984	4,099	4,214	4,351	4,526	4,738	4,948	4,285	4,606	5,625	6,276	6,921

To Order Select Below

1. Series

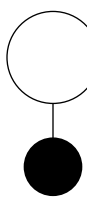

CV

Cove Lounge

2. Style/Base

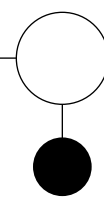

Lounge

450 LOUNGE CHAIR, WOOD CAPPED BASE, FIXED-HEIGHT SWIVEL
 452 LOUNGE CHAIR, WOOD CAPPED BASE, FIXED-HEIGHT NO SWIVEL

High Back

350 HIGH BACK CHAIR, WOOD CAPPED BASE, FIXED-HEIGHT SWIVEL
 352 HIGH BACK CHAIR, WOOD CAPPED BASE, FIXED-HEIGHT NO SWIVEL

3. Dual Upholstery Option

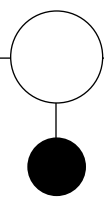

Dual Upholstery Option

DF1 DUAL UPHOLSTERY

Dual Upholstery allows for different fabrics on the seat and shell. When specifying In-Graded fabrics, please apply the higher of the two grades. Fabric and Leather combinations are only available as COM/COL orders. Fabric and Leather combinations are only available as COM/COL orders.

Textile (yd) and leather (sqft) quantities for dual upholstery are the following:

Lounge Chair
 Seat: 1 yd / 9 sqft
 Shell: 2 yd / 31 sqft

High Back Chair
 Seat: 1.1 yd / 9 sqft
 Shell: 2.8 yd / 37 sqft

4. Options

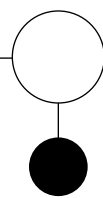

Options

CT CONTRASTING THREAD

5. Wood Finish

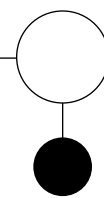

Wood Finish

81 WHITE OAK
 83 NATURAL MAPLE
 85 WALNUT **+138**
 87 OPAQUE BLACK

6. Frame Finish

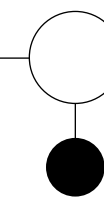

Standard Powder Coated Metal

BL BLUE	NK NICKEL
BM BLACK MATTE	NV NAVY
BR BRASS	OR ORANGE
BT BLACK TWILIGHT	PY PALE YELLOW
CP CHAMPAGNE	RD RED
DB DARK BRONZE	RO RED ORANGE
DG DARK GRAY	RR RUSTY RED
DP DUSTY PINK	SB SOFT BLUE
FG FOREST GREEN	SD SAND
LG LIGHT GRAY	TC TERRACOTTA
MG MEADOW GREEN	TP TAUPE
MK MILK	TS TEXTURED SLATE
MS METALLIC SILVER	YL YELLOW

Colors apply to the metal base plate and column between the wood legs.

7. Upholstery

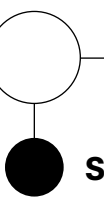

See general information section for details on textile program and COM/COL information.

Cove Textile Precautions
 Fabrics are cut railroad. Certain horizontal stripes, plaids, or fabrics with very little stretch are not acceptable for use on this product.

All textiles and leathers must be pre-approved for this product. Cove may develop mild comfort wrinkles on the inside back and seat when specified with leather or fabrics that do not recover well.

Cove Lounge

CHAIR: SLED BASE

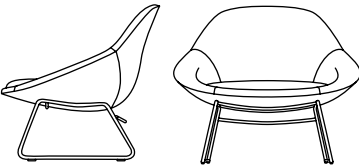
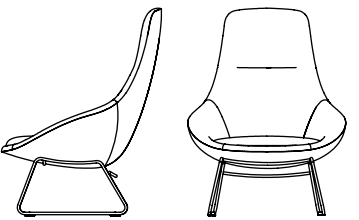
	SERIES	STYLE	COM YDG	COL SQ FT	Textile Upholstery Grades											Leather Upholstery Grades					
					COM	A	B	C	D	E	F	G	H	I	J	K	W	X	Y	E1	E2
Lounge Chair Sled Base 	CV	410	2.8	41	2,442	2,648	2,758	2,865	2,979	3,088	3,210	3,333	3,477	3,662	3,885	4,109	3,640	3,950	4,957	5,375	6,508
High Back Chair Sled Base 	CV	310	3.0	47	2,770	2,964	3,070	3,173	3,278	3,385	3,501	3,615	3,753	3,927	4,139	4,349	3,687	4,008	5,026	5,676	6,322

To Order Select Below

1. Series

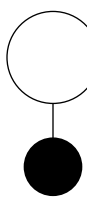

CV

Cove Lounge

2. Style/Base

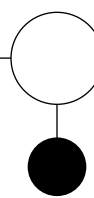

Lounge

410 LOUNGE CHAIR, SLED BASE

High Back

310 HIGH BACK CHAIR, SLED BASE

3. Dual Upholstery Option

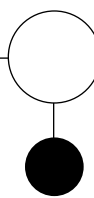

Dual Upholstery Option

DF1 DUAL UPHOLSTERY

Dual Upholstery allows for different fabrics on the seat and shell. When specifying In-Graded fabrics, please apply the higher of the two grades. Fabric and Leather combinations are only available as COM/COL orders. Fabric and Leather combinations are only available as COM/COL orders.

Textile (yd) and leather (sqft) quantities for dual upholstery are the following:

Lounge Chair
Seat: 1 yd / 9 sqft
Shell: 2 yd / 31 sqft

High Back Chair
Seat: 1.1 yd / 9 sqft
Shell: 2.8 yd / 37 sqft

4. Options

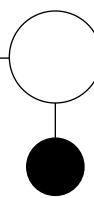

Options

CT CONTRASTING THREAD

5. Frame Finish

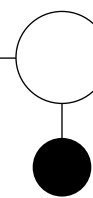

Standard Powder Coated Metal

- BL BLUE
- BM BLACK MATTE
- BR BRASS
- BT BLACK TWILIGHT
- CP CHAMPAGNE
- DB DARK BRONZE
- DG DARK GRAY
- DP DUSTY PINK
- FG FOREST GREEN
- LG LIGHT GRAY
- MG MEADOW GREEN
- MK MILK
- MS METALLIC SILVER

- NK NICKEL
- NV NAVY
- OR ORANGE
- PY PALE YELLOW
- RD RED
- RO RED ORANGE
- RR RUSTY RED
- SB SOFT BLUE
- SD SAND
- TC TERRACOTTA
- TP TAUPE
- TS TEXTURED SLATE
- YL YELLOW

Chrome

CH BRIGHT CHROME

6. Upholstery

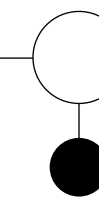

See general information section for details on textile program and COM/COL information.

Cove Textile Precautions
Fabrics are cut railroad. Certain horizontal stripes, plaids, or fabrics with very little stretch are not acceptable for use on this product.

All textiles and leathers must be pre-approved for this product. Cove may develop mild comfort wrinkles on the inside back and seat when specified with leather or fabrics that do not recover well.

Cove Lounge

CHAIR: WOOD LEG

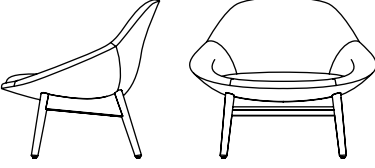
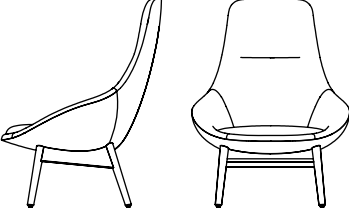
	SERIES	STYLE	COM		Textile Upholstery Grades												Leather Upholstery Grades				
			YDG	SQ FT	COM	A	B	C	D	E	F	G	H	I	J	K	W	X	Y	E1	E2
Lounge Chair Wood Leg 	CV	460	2.8	41	2,925	3,127	3,236	3,341	3,451	3,561	3,680	3,799	3,941	4,122	4,341	4,558	3,990	4,287	5,241	5,692	6,647
High Back Chair Wood Leg 	CV	360	3.0	47	3,043	3,241	3,348	3,451	3,560	3,667	3,784	3,902	4,039	4,218	4,433	4,647	4,256	4,594	5,679	6,194	7,281

To Order Select Below

1. Series

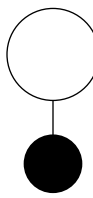

CV

Cove Lounge

2. Style/Base

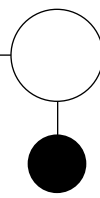

Lounge

460 LOUNGE CHAIR, WOOD LEGS

High Back

360 HIGH BACK CHAIR, WOOD LEGS

3. Dual Upholstery Option

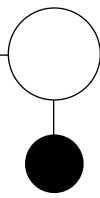

Dual Upholstery Option

DF1 DUAL UPHOLSTERY

Dual Upholstery allows for different fabrics on the seat and shell. When specifying In-Graded fabrics, please apply the higher of the two grades. Fabric and Leather combinations are only available as COM/COL orders. Fabric and Leather combinations are only available as COM/COL orders.

Textile (yd) and leather (sqft) quantities for dual upholstery are the following:

Lounge Chair
 Seat: 1 yd / 9 sqft
 Shell: 2 yd / 31 sqft

High Back Chair
 Seat: 1.1 yd / 9 sqft
 Shell: 2.8 yd / 37 sqft

4. Options

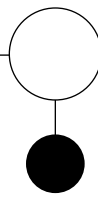

Options

CT CONTRASTING THREAD

5. Wood Finish

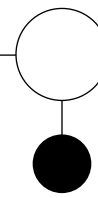

Wood Finish

81	WHITE OAK	+173
83	NATURAL MAPLE	+86
85	WALNUT	+290
87	OPAQUE BLACK	

6. Upholstery

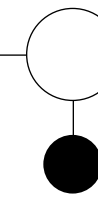

See general information section for details on textile program and COM/COL information.



Cove Textile Precautions

Fabrics are cut railroad. Certain horizontal stripes, plaids, or fabrics with very little stretch are not acceptable for use on this product.

All textiles and leathers must be pre-approved for this product. Cove may develop mild comfort wrinkles on the inside back and seat when specified with leather or fabrics that do not recover well.

Cove Lounge

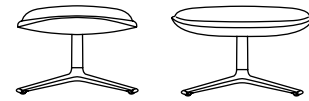
OTTOMAN

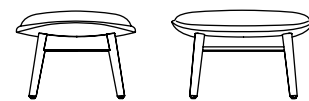
	SERIES	STYLE	COM	COL	Textile Upholstery Grades												Leather Upholstery Grades				
					COM	A	B	C	D	E	F	G	H	I	J	K	W	X	Y	E1	E2
Ottoman Four-Blade Aluminum Base 	CV	572	1.0	23	1,293	1,376	1,420	1,464	1,507	1,551	1,601	1,649	1,707	1,781	1,870	1,960	1,811	1,946	2,385	2,565	3,058
Ottoman Sled Base 	CV	510	1.0	23	1,293	1,376	1,420	1,464	1,507	1,551	1,601	1,649	1,707	1,781	1,870	1,960	1,811	1,946	2,385	2,565	3,058
Ottoman Wood Leg 	CV	560	1.0	23	1,470	1,542	1,581	1,619	1,658	1,697	1,740	1,783	1,833	1,897	1,976	2,054	2,062	2,227	2,756	3,007	3,537

To Order Select Below

1. Series

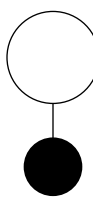

CV

Cove Lounge

2. Style/Base

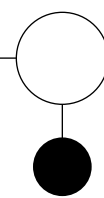

Ottoman

572 OTTOMAN, CAST ALUMINUM BASE, NO SWIVEL

510 OTTOMAN, SLED BASE

560 OTTOMAN, WOOD LEGS

3. Dual Upholstery Option

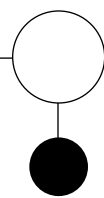

Dual Upholstery Option

DF1 DUAL UPHOLSTERY

Dual Upholstery allows for different fabrics on the seat and shell. When specifying In-Graded fabrics, please apply the higher of the two grades. Fabric and Leather combinations are only available as COM/COL orders. Fabric and Leather combinations are only available as COM/COL orders.

Textile (yd) and leather (sqft) quantities for dual upholstery are the following:

Ottoman

Seat: 1 yd / 10 sqft

Shell: 1 yd / 11 sqft

4. Options

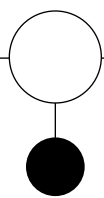

Options

CT CONTRASTING
THREAD

5. Wood Finish

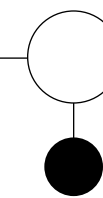

Wood Finish

81 WHITE OAK **+129**

83 NATURAL MAPLE **+74**

85 WALNUT **+258**

87 OPAQUE BLACK

*For Wood Leg Base only

6. Frame Finish

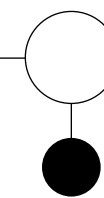

Standard Powder Coated Metal

BL BLUE

BM BLACK MATTE

BR BRASS

BT BLACK TWILIGHT

CP CHAMPAGNE

DB DARK BRONZE

DG DARK GRAY

DP DUSTY PINK

FG FOREST GREEN

LG LIGHT GRAY

MG MEADOW GREEN

MK MILK

MS METALLIC SILVER

NK NICKEL

NV NAVY

OR ORANGE

PY PALE YELLOW

RD RED

RO RED ORANGE

RR RUSTY RED

SB SOFT BLUE

SD SAND

TC TERRACOTTA

TP TAUPE

TS TEXTURED SLATE

YL YELLOW

Polished Metal

AL POLISHED ALUMINUM

**For Sled Base only

CH** BRIGHT CHROME

7. Upholstery

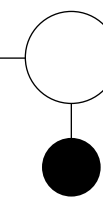

See general information section for details on textile program and COM/COL information.

Cove Textile Precautions

Fabrics are cut railroad. Certain horizontal stripes, plaids, or fabrics with very little stretch are not acceptable for use on this product.

All textiles and leathers must be pre-approved for this product. Cove may develop mild comfort wrinkles on the inside back and seat when specified with leather or fabrics that do not recover well.

stylex

Dau

PRICE LIST

Effective November 01, 2023

General Information

GENERAL INFORMATION

Terms

Net 30 days from date of invoice.
FOB Delanco, NJ

Damaged Shipments

All Stylex products are carefully inspected before they are packed in sturdy cartons designed to satisfy shipping requirements. Stylex is not responsible for damage in shipment. The transportation company assumes responsibility for delivering products to you in good condition when the bill of lading is signed. You protect yourself by refusing shipments showing damage or shortage until transportation company has noted on the delivery sheet the extent of damage or shortage. Concealed damage should be reported to the carrier as soon as discovered, but not later than 15 days after receiving shipment.

Return/Restocking Policy

Return shipments will not be accepted unless specifically authorized by Stylex in writing. The Return Authorization number should be clearly marked on the carton. The customer returning Stylex products is responsible for return shipping costs. Merchandise must be returned unused. Returned merchandise is subject to a 35% restocking fee.

Specials/Customs

Modifications to standard products will be considered for large runs. Contact Stylex for more information.

Design Changes

In keeping with modern manufacturing advances, Stylex reserves the right to incorporate minor modifications and design changes in products without notice.

Cancellation Policy

No charge prior to production except for inventory specifically requisitioned to fulfill the particular order. After production has begun, only actual costs incurred, including labor and material, will be billed to the customer.

WARRANTY

Except as provided below, Stylex warrants exclusively to the original Purchaser of our product that all parts, under normal use and service, will be free from defects in workmanship and material for a period of ten (10) years from the date of purchase. "Normal use and service" means that the product will be used in a typical office environment for 40-45 hours per week.

This warranty is subject to the following limitations, exclusions and provisions:

Wood components of plywood stacking chairs
(such as Brooks and Welcome)
5 years

Upholstery
(including mesh used for Click, F4, Insight, and Zephyr Mesh)
3 years

SAVA Mesh
10 years

COM Upholstery
No warranty
Stylex makes every effort to ensure that the COM Upholstery it approves is suitable for the intended use. Nevertheless, we will not warrant, and assume no responsibility for, the durability or tailoring quality of any COM or COL. If you have any concerns about the ultimate appearance of any covering, please order an upholstered sample.

Painted Stack Chair Frames
No Warranty
We will not warrant the finish of painted stack chair frames against damage from stacking. We recommend ordering chrome frames for chairs that will be stacked.

Felt Glides
No warranty
Due to the different surfaces on which felt glides may be used, we cannot warrant their durability over time.

If this product fails during normal use and service within the applicable warranty period (other than through normal wear and tear), please send a description of the relevant part and the nature of the defect, together with proof of purchase of the product, to Stylex at: Customer Service. c/o Stylex, P.O. Box 5038, Delanco, NJ 08075. PLEASE DO NOT RETURN PARTS OR THE PRODUCT TO STYLEX UNLESS INSTRUCTED TO DO SO BY STYLEX. Stylex will, at its option, either repair or replace the product or the part found defective by Stylex completely without charge for materials or labor. Purchaser may be required (at the option of Stylex) to return to Stylex at Purchaser's expense any defective part with all freight or shipping charges prepaid. The foregoing warranty shall be void if the product has been altered or repaired (other than by Stylex). The warranty does not cover damage to the product caused by accident, neglect, misuse, abuse, modification to the product by anyone other than Stylex or damage caused by use of the product for a purpose other than that for which it was designed. This warranty extends only to the original Purchaser of the product.

No Other Warranties

This warranty is in lieu of all other warranties, expressed or implied, including, but not limited to, implied warranties of merchantability and fitness for a particular purpose. The rights and remedies provided herein are the exclusive rights and remedies of the original purchaser of the product.

No Liability For Damages

In no event shall Stylex or its suppliers be responsible or liable for any special, indirect, consequential, or incidental damages. In no event shall the liability of Stylex exceed the actual purchase price paid to Stylex for the product.

Out of Warranty Products

For all products no longer covered by our warranty, please refer to our Design for Durability and Upgradability Policy. Contact Customer Service if you would like to purchase any replaceable components to further extend the life of any Stylex seating product. This warranty applies to all Stylex products purchased on April 13, 2018, and thereafter.

PRODUCT TAKE BACK PROGRAM

At Stylex, responsible stewardship of our products extends beyond their initial use. Our Product Take Back Program provides a practical solution for the end of our products' intended life cycle.

Through our partnership with ANEW, a 501(c)(3) nonprofit organization, we offer clients a comprehensive take-back solution for surplus office furniture and materials, regardless of their condition. ANEW's mission aligns with ours—to connect surplus resources with non-profits, public agencies, and underserved communities, minimizing landfill impact and maximizing corporate social responsibility.

By repurposing surplus items, we strengthen community networks and reduce environmental impact. Stylex proudly supports ANEW, integrating this partnership into our strategic sales strategy since 2014. Learn more at www.anewfound.org.

Initiate a Product Take Back through ANEW by emailing Stylex at info@stylexdesign.com. For additional end-of-life recovery options, refer to our Product Disassembly Instructions and End of Life Recovery Options documents, available in the Resources section of each product on our website. Together, let's build a sustainable future.

FREIGHT PROGRAM

Stylex offers a Guaranteed Freight Program, which provides the purchaser the ability to determine shipping and handling charges at the time of order. Freight charges will be calculated as a percentage of the net product price and added to the invoice at the time of shipment. The continental United States has been divided into three zones. Please use the map below to determine the freight charges for the product's destination. There is a minimum freight charge of \$150.

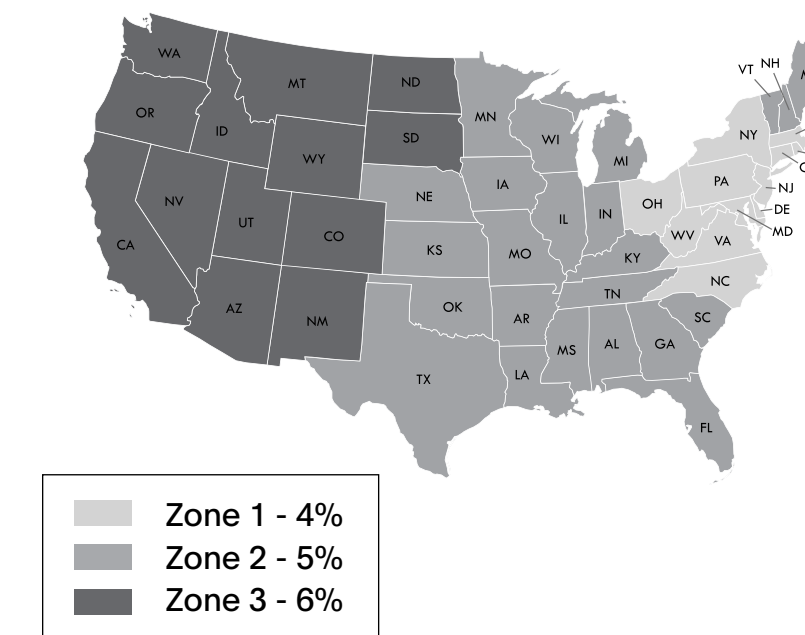

ZONE 1 - 4%

Connecticut
Delaware
New York
New Jersey
Maryland
Massachusetts
North Carolina
Ohio
Pennsylvania
Rhode Island
Virginia
Washington D.C.
West Virginia

ZONE 2 - 5%

Alabama
Arkansas
Canada, Ontario
Canada, Quebec
Florida
Georgia
Iowa
Illinois
Indiana
Kansas
Kentucky
Louisiana
Nebraska
New Hampshire
Oklahoma
Maine
Michigan
Minnesota
Mississippi
South Carolina
Tennessee
Texas
Vermont
Wisconsin

ZONE 3 - 6%

Arizona
California
Colorado
Idaho
Montana
Nevada
New Mexico
North Dakota
Oregon
South Dakota
Utah
Washington
Wyoming

Quote Per Project

Alaska
Hawaii
Canada
(outside Ontario & Quebec)
Mexico

General Information

TEXTILE PARTNERS & APPROVALS

Textile Partners

To customize your furniture performance needs and design vision, Stylex offers a wide selection of in-graded leathers and textiles from Grades A through Y. We've partnered with leading manufacturers on the options, focusing on color, price, durability, and construction. To view our partners and explore our digital carded program with broadly approved textiles, visit [this page](#). We stand by these textiles: They're tried and tested, and will effortlessly fit into any design aesthetic.

Textile Approvals

To view Stylex Approved Textile documents to determine specific product approval status, refer to our Product Tested Textiles documents, available in the Resources section of each product on our website.

CAL 117 AND 133 COMPLIANCE

CAL 117-2013

All Stylex seating satisfies the requirements of CAL 117-2013 so long as one of our standard or in-graded textiles is applied. COM textiles cannot be so guaranteed. Please contact the supplier of COM's directly to determine the fire retardancy of any COM supplied to us.

CAL 133

Most Stylex seating can be ordered to meet the requirements of CAL 133. When ordering, simply specify "CAL 133 compliance required". The upcharge for this option is \$54 list per yard. Please refer to the COM yardage of each model to determine the number of yards required. We do frequently require full-scale burn tests in order to certify CAL 133 before an order will be accepted. Such burn tests may increase normal lead times and do carry additional charges. Please contact customer service for details.

CUSTOMER'S OWN MATERIAL/LEATHER

Customer's own material (COM) and customer's own leather (COL) will generally be upholstered at the price designated in each product's price list. Please be advised, however, that we specifically reserve the right to charge a higher price when we determine that special circumstances, such as unusual repeats or challenging materials, present themselves. All orders for custom coverings must be approved by Stylex before they will be accepted for production. To submit proposed textile for approval, please use the COM form [here](#).

Special Note:

We assume no responsibility for the durability or tailoring quality of any COM or COL. Directional covers in particular may not meet your satisfaction due to the design of certain products. Please be advised that COM and COL orders are not subject to return. If you have doubts about the ultimate appearance of certain coverings, please order a sample done with that specific COM or COL. In addition, while we inspect textiles for mill imperfections, some are difficult to recognize. We cannot be responsible for defects, color inaccuracies, dye lot variations, or other flaws.

Under no circumstances will we be responsible for COM shortages, flaws, or other such problems. Finally, it is not our responsibility to police the receipt of COM's in order to meet delivery deadlines, and we assume our customers are aware of any undue delay in the shipment of their COM textiles.

COM textile and COL leather should be sent prepaid to: Stylex

**Attn: COM/COL - [Your PO #]
740 Coopertown Road
Delanco, NJ 08075**

Clearly mark textile or leather with the dealer's name, purchase order number, and furniture model number of the item to be covered. Actual furniture orders should include the same information, as well as a description of the textile or leather, including pattern and color number, in order to provide a cross reference.

Yardage requirements shown in the price list are based on non-directional goods of 54" width. Textiles less than 54" wide or those requiring matching (stripes, prints, or large patterned designs) call for additional yardage. We will be happy to supply yardage requirements for large quantities where economies may be realized.

Add the following yardage for stripes, plaids, or patterns with repeats:

Textile Width	Plain Textile	2-14" Repeat	15-24" Repeat	25-27" Repeat	28-36" Repeat
54"	0%	10%	15%	20%	25%
50"	10%	20%	25%	30%	35%
48"	15%	25%	30%	35%	40%
45"	40%	50%	55%	60%	65%
36"	50%	60%	65%	70%	75%

COM/COL FORM

To avoid delay in processing COM orders we request that you submit a sample of your COM textile stapled to this form which can be downloaded [here](#). If a textile has a stripe or design, the size of the repeat should be indicated. Please indicate the textile supplier's name, textile number, and color. Also indicate the Stylex product on which the textile will be used.

The textile supplier must indicate on his shipping labels the dealer name and purchase order number as well as the Stylex model number.

Please Note:

No order may be entered into production or have a shipping date assigned until all related COM is received at the factory.



CENTER OF STRIPE OR DESIGN

TOP	TOP
-----	-----

1. Size of Repeat

2. Textile Supplier

3. Textile Number

4. Color

5. Stylex Product

Contents

<hr/>		<hr/>	
COLORS, MATERIALS, AND FINISHES	5	LOUNGE	13
STATEMENT OF LINE	6	POUFS WITH CASTERS	14
DIMENSIONS	7	LOUNGE WITH CASTERS	15
HOW TO ORDER	8	TABLES	16
TABLET ARM RULES	10	TABLET ARM	18
POUFS	11		
<hr/>			

CLICK THE TITLES ABOVE TO NAVIGATE THROUGH THE DOCUMENT
PRODUCT HEADERS ON SUBSEQUENT PAGES LINK BACK TO THIS PAGE

Dau

COLORS, MATERIALS, AND FINISHES

POWDER COATED METAL

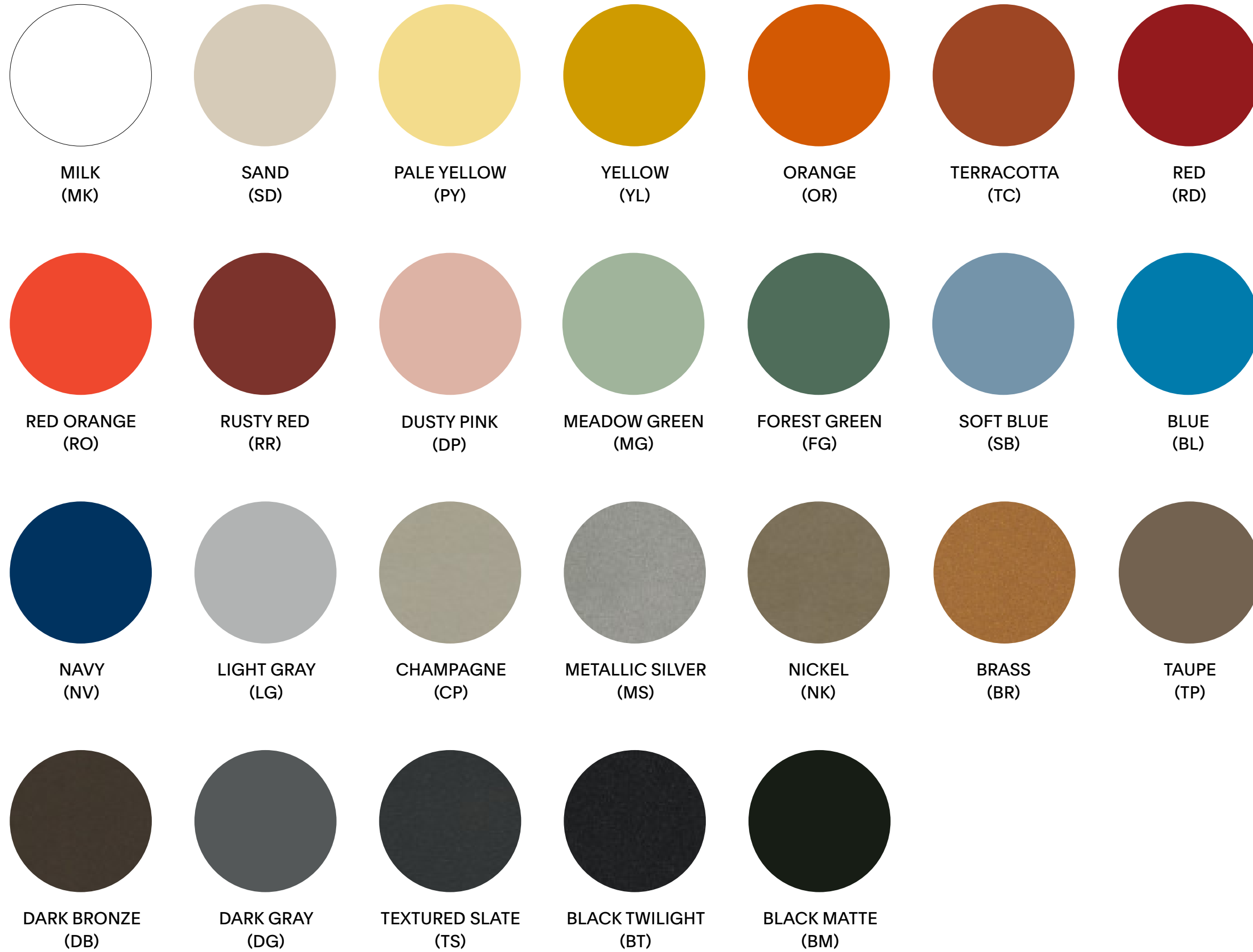

LEATHER & FELT (HANDLES)





SOLID WOODS

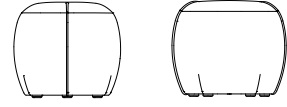
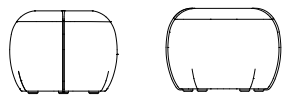
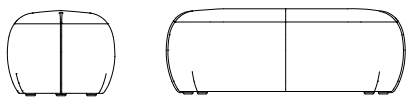
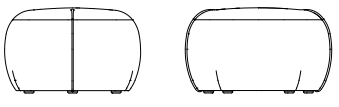
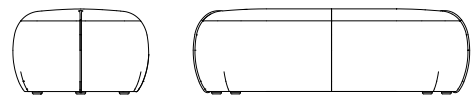
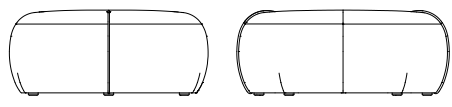
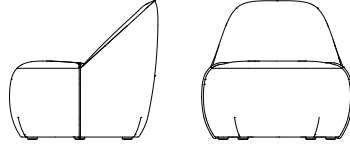
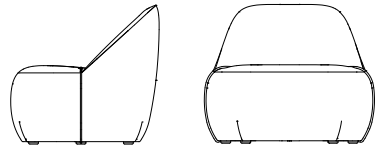
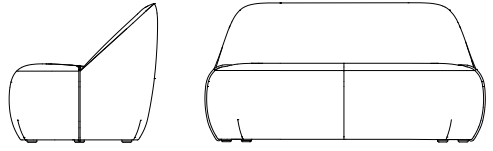
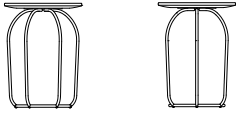
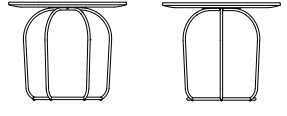
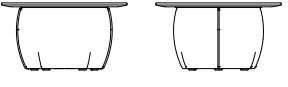

Dau

SPECIFICATION GUIDE: STATEMENT OF LINE

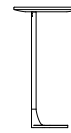
OVERVIEW						
Pouf	Pouf Mini Task 	Pouf Mini Lounge 	Pouf Mini Double 	Pouf Single 	Pouf Double 	Pouf Island 
Lounge	Lounge Single 	Lounge Single Plus 	Lounge Double 			
Tables	Wire Base Table Small 	Wire Base Table Medium 	Upholstered Table Large 			
Tablet	Tablet, for use with Lounge 	Tablet, for use with Pouf Lounge 				

OPTIONS		
Felt Handles 	Leather Handles 	

PRODUCT INFORMATION
<p>Design Yonoh Studio</p> <p>Seating Glides Dau seating is available with 3 glide options: plastic, rubber, and felt.</p> <p>Seating Casters Self Locking Casters automatically brake when body weight is applied to the seat surface. Available with soft wheels. Casters are unavailable for Pouf Mini Single, Pouf Mini Double, and Pouf Island.</p> <p>Seating Handles Handles are required when casters are selected. Handles are optional only for Pouf Mini Single and Pouf Single.</p> <p>Tables & Tablet Arms Options include solid wood in oak, maple, walnut, and opaque black. The tablet arm's surface is designed to rotate 360 degrees, providing ease of use and comfort for its user. The tablet arm is an ancillary piece that is installed by the customer. It can be removed or added as desired. See page 11 for additional tablet arm information.</p> <p>Wood Finishes The beauty of wood lies in its natural grain patterns, which are unique to each piece of wood. As such, exposed wood surfaces will not offer the same consistency as man-made materials. Some variation in color, grain, and texture are to be expected, even within the same order. Another consideration is that wood components will tend to darken over time, exaggerating slightly naturally occurring differences.</p> <p>Use Designed for indoor use only.</p> <p>Performance Standards Manufactured to comply with: ANSI/BIFMA X5.4 Lounge Seating - Tests ANSI/BIFMA X5.5 Desk and Table Product - Tests</p> <p>Certifications GREENGUARD Gold - Seating GREENGUARD - Tables LEVEL® 1</p>

Dau

SPECIFICATION GUIDE: DIMENSIONS

DIMENSIONS							
<p>Poufs</p> <ul style="list-style-type: none"> A. Seat Height B. Seat Depth C. Overall Depth D1. Overall Width D2. Seat Width 		<p>Pouf Mini Task</p> <ul style="list-style-type: none"> A. 17.75" B. 20" C. 22.5" D1. 24" D2. 21" 	<p>Pouf Mini Lounge</p> <ul style="list-style-type: none"> A. 15.75" B. 20" C. 22.5" D1. 24" D2. 21" 	<p>Pouf Mini Double</p> <ul style="list-style-type: none"> A. 15.75" B. 20" C. 22.5" D1. 49" D2. 46" 	<p>Pouf Single</p> <ul style="list-style-type: none"> A. 15.75" B. 25" C. 28" D1. 30" D2. 27" 	<p>Pouf Double</p> <ul style="list-style-type: none"> A. 15.75" B. 25" C. 28" D1. 57" D2. 53.5" 	<p>Pouf Island</p> <ul style="list-style-type: none"> A. 15.75" B. 38" C. 41" D1. 44" D2. 41"
<p>Lounge</p> <ul style="list-style-type: none"> A. Seat Height B. Seat Depth C. Back Height D1. Overall Width D2. Seat Width E. Overall Height F. Overall Depth 		<p>Lounge Single</p> <ul style="list-style-type: none"> A. 14.5" B. 20.25" C. 13.5" D1. 31" D2. 27" E. 28.25" F. 30.5" 	<p>Lounge Single Plus</p> <ul style="list-style-type: none"> A. 14.5" B. 20.25" C. 13.5" D1. 35" D2. 31" E. 28.25" F. 30.5" 	<p>Lounge Double</p> <ul style="list-style-type: none"> A. 14.5" B. 20.25" C. 13.5" D1. 57" D2. 53" E. 28.25" F. 30.5" 			
<p>Tables</p> <ul style="list-style-type: none"> A. Width B. Height 		<p>Wire Base Table Small</p> <ul style="list-style-type: none"> A. 15.75" B. 21.32" 	<p>Wire Base Table Medium</p> <ul style="list-style-type: none"> A. 22.88" B. 20.88" 	<p>Upholstered Table Large</p> <ul style="list-style-type: none"> A. 32" B. 17.13" 			
<p>Tablet</p> <ul style="list-style-type: none"> A. Height B. Diameter C. Min. - Max. Overall Width with Tablet Arm Swivel* 		<p>Tablet, for use with Lounge</p> <ul style="list-style-type: none"> A. 25" B. 14" C. 32" - 38" 	<p>Tablet, for use with Pouf Lounge</p> <ul style="list-style-type: none"> A. 26.5" B. 14" C. 31" - 37" 				
<p>*The Tablet Arm extends beyond the seated units width 1-7" depending on it's swivel location.</p>							

Dau

SPECIFICATION GUIDE: HOW TO ORDER - LOUNGE

MODEL CODE BREAKDOWN - SEATING

Sample Model Code: **DU11016SLBSHDF01COM**

1. Series

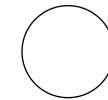

DU

Series

DU DAU

2. Model

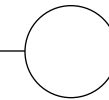

11016

Model

01003	POUF MINI SINGLE LOUNGE SEAT HEIGHT
01005	POUF MINI SINGLE, TASK SEAT HEIGHT
02003	POUF MINI DOUBLE, LOUNGE SEAT HEIGHT
01013	POUF SINGLE, LOUNGE SEAT HEIGHT
02013	POUF DOUBLE, LOUNGE SEAT HEIGHT
04023	POUF ISLAND, LOUNGE SEAT HEIGHT
11016	LOUNGE SINGLE
11516	LOUNGE SINGLE PLUS
12016	LOUNGE DOUBLE

3. Glides/Casters

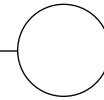

PG

Style

Glides	
PG	PLASTIC GLIDE
RG	RUBBER GLIDE
FG	FELT GLIDE

Casters

SLBS	SELF-LOCKING BLACK SOFT WHEEL CASTER
------	---

4. Handle Material + Finish

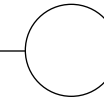

HDF01

Handle Material

~	NONE
HDF	FELT
HDL	LEATHER

Felt Finish

01	BLACK
02	ANTHRACITE
03	STEEL
04	LIGHT GRANITE
05	DARK NUTMEG
06	BARK
07	CAMEL
08	SANDSTONE

Leather Finish

01	BLACK WEST TAN
02	PEANUT WEST TAN
03	VEGETABLE TANNED

5. Textile

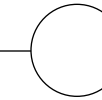

COM

Textile Grades

COM	CUSTOMER'S OWN MATERIAL
A	GRADE A
B	GRADE B
C	GRADE C
D	GRADE D
E	GRADE E
F	GRADE F
G	GRADE G
H	GRADE H
I	GRADE I
J	GRADE J
K	GRADE K
L	GRADE L
M	GRADE M

Dau

SPECIFICATION GUIDE: HOW TO ORDER - TABLES AND TABLETS

MODEL CODE BREAKDOWN - TABLES

Sample Model Code: **DU503PG81COM**

1. Series

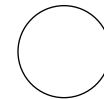

DU

Series

DU DAU

2. Model

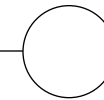

503

Model

501 WIRE TABLE SMALL
 502 WIRE TABLE MEDIUM
 503 UPHOLSTERED TABLE LARGE
 5043 TABLET ARM, POUF LOUNGE
 5046 TABLET ARM, LOUNGE

3. Glides

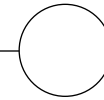

PG

Glides

PG PLASTIC GLIDE
 RG RUBBER GLIDE
 FG FELT GLIDE

Note: Glides only available on Upholstered Table Large

4. Base Finish

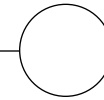

Standard Powder Coated Metal

BL BLUE
 BM BLACK MATTE
 BR BRASS
 BT BLACK TWILIGHT
 CP CHAMPAGNE
 DB DARK BRONZE
 DG DARK GRAY
 DP DUSTY PINK
 FG FOREST GREEN
 LG LIGHT GRAY
 MG MEADOW GREEN
 MK MILK
 MS METALLIC SILVER
 NK NICKEL
 NV NAVY
 OR ORANGE
 PY PALE YELLOW
 RD RED
 RO RED ORANGE
 RR RUSTY RED
 SB SOFT BLUE
 SD SAND
 TC TERRACOTTA
 TP TAUPE
 TS TEXTURED SLATE
 YL YELLOW

Chrome

CH CHROME

Not available on Upholstered Table Large

5. Solid Wood Finish

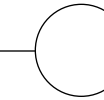

SW81

Solid Wood

SW81 WHITE OAK
 SW83 NATURAL MAPLE
 SW85 WALNUT
 SW87 OPAQUE BLACK

6. Textile

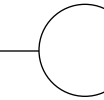

COM

Textile Grades

COM CUSTOMER'S OWN MATERIAL
 A GRADE A
 B GRADE B
 C GRADE C
 D GRADE D
 E GRADE E
 F GRADE F
 G GRADE G
 H GRADE H
 I GRADE I
 J GRADE J
 K GRADE K
 L GRADE L
 M GRADE M

Dau

SPECIFICATION GUIDE: TABLET ARM RULES

LOCATION RULES

The Tablet Arm is an ancillary piece that is installed by the customer. It can be removed or added as desired.

Tablet Arms are not available on Pouf Mini Lounge, Pouf Mini Task, Pouf Mini Double, and Pouf Island.

The top view diagrams below depict all possible locations for tablet arms on Dau seating units.

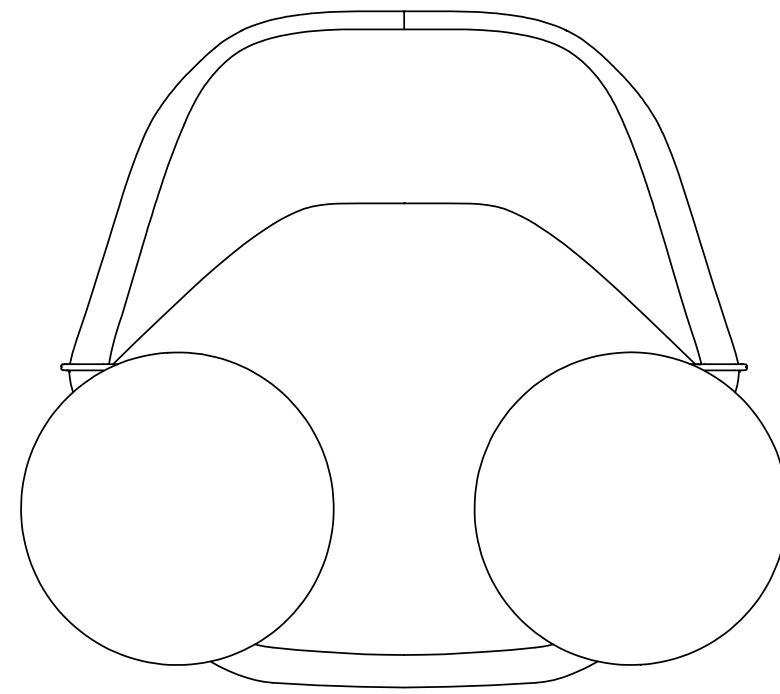

Lounge Single
Lounge Single Plus
Lounge Double

Position Left or Right

Up to two tablets available for Lounge Double, only one for Lounge Single and Single Plus.

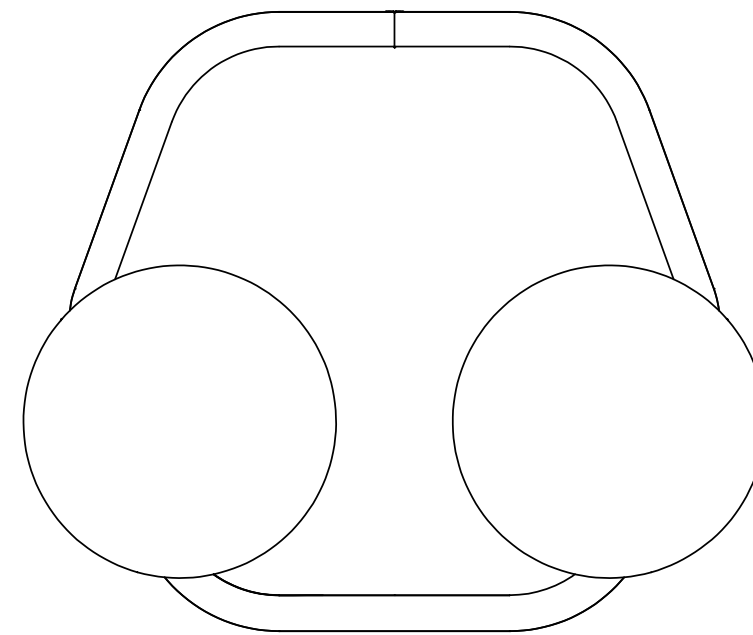

Pouf Single

Position Left or Right

Only one tablet per unit

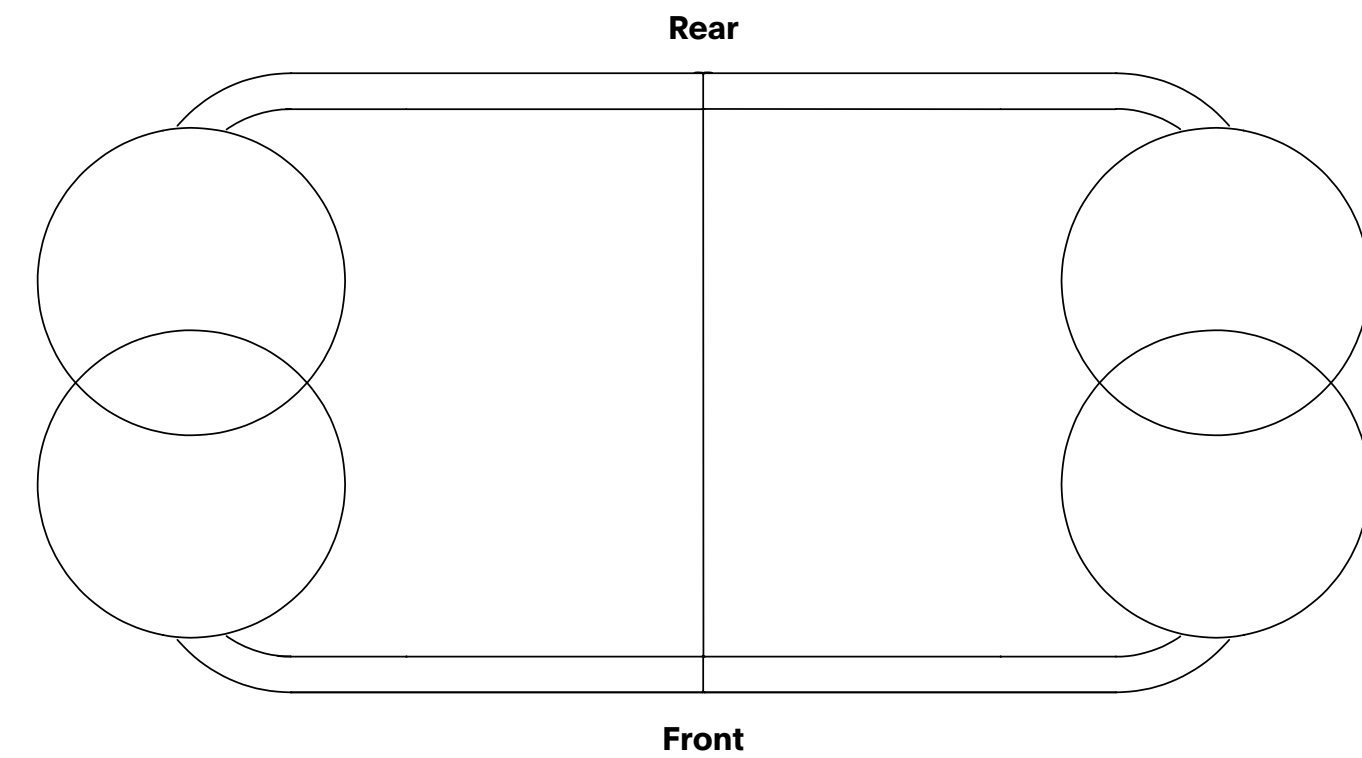

Pouf Double

Position Front Left, Front Right, Rear Left or Rear Right

Up to two tablets per unit. If two tablet arms are specified, they must be installed on opposite sides to avoid interference of tablet arm rotation as depicted above.

Dau

POUF MINI

Textile Upholstery Grades

COM

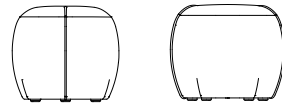
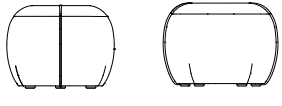
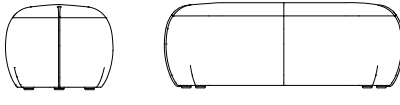
TITLE	SERIES	UNIT	TYPE	HEIGHT	DIMENSIONS	YDG	COM	A	B	C	D	E	F	G	H	I	J	K	L	M	
Pouf, Mini Single, Task Height	DU	0	100	5	24W x 22.5D x 17.75H	2.0	1,288	1,422	1,494	1,565	1,638	1,710	1,790	1,869	1,964	2,085	2,230	2,377	2,516	2,650	
																					
Pouf, Mini Single, Lounge Height	DU	0	100	3	24W x 22.5D x 15.75H	2.0	1,257	1,390	1,463	1,533	1,607	1,679	1,759	1,838	1,932	2,054	2,199	2,346	2,484	2,619	
																					
Pouf, Mini Double	DU	0	200	3	49W x 22.5D x 15.75H	3.3	1,959	2,188	2,312	2,433	2,558	2,683	2,820	2,956	3,116	3,325	3,574	3,826	4,065	4,295	
																					

To Order Select Below

1. Series/Model

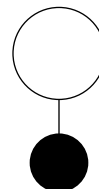

DU01005

**Pouf
Mini Single
Task Seat Height**

DU01003

**Pouf
Mini Single
Lounge Seat Height**

DU02003

**Pouf
Mini Double**

2. Glides

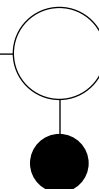

Glides

PG PLASTIC GLIDE

RG RUBBER GLIDE **+14**

FG FELT GLIDE **+19**

3. Handle Finish

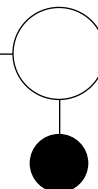

Felt Handle +34

01 BLACK

02 ANTHRACITE

03 STEEL

04 LIGHT GRANITE

05 DARK NUTMEG

06 BARK

07 CAMEL

08 SANDSTONE

Leather Handle +67

01 BLACK WEST TAN

02 PEANUT WEST TAN

03 VEGETABLE TANNED

Option only available on Pouf Mini
Single

4. Upholstery

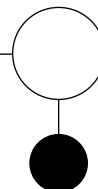

**See general
information section
for details on textile
program and
COM information**

**Textiles are cut up
the roll by default**

Dau

POUF

Textile Upholstery Grades

COM

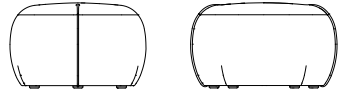
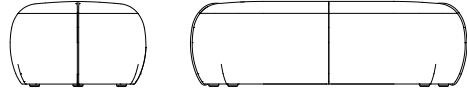
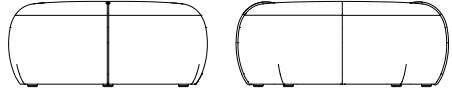
TITLE	SERIES	UNIT	TYPE	HEIGHT	DIMENSIONS	YDG	COM	A	B	C	D	E	F	G	H	I	J	K	L	M
Pouf, Single 	DU	0	101	3	30W x 28D x 15.75H	2.0	1,572	1,705	1,778	1,848	1,922	1,994	2,074	2,153	2,247	2,369	2,514	2,661	2,799	2,934
Pouf, Double 	DU	0	201	3	44W x 28D x 15.75H	3.6	2,581	2,830	2,963	3,094	3,230	3,364	3,513	3,660	3,835	4,060	4,330	4,603	4,862	5,110
Pouf, Island 	DU	0	402	3	57W x 28D x 15.75H	3.9	2,889	3,156	3,300	3,442	3,587	3,732	3,893	4,051	4,239	4,481	4,772	5,066	5,345	5,612

To Order Select Below

1. Series/Model

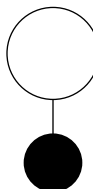

DU01013

**Pouf
Single
Lounge Seat Height**

DU02013

**Pouf
Double
Lounge Seat Height**

DU04023

**Pouf
Island
Lounge Seat Height**

2. Glides

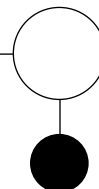

Glides

PG	PLASTIC GLIDE	
RG	RUBBER GLIDE	+14
FG	FELT GLIDE	+19

3. Handle Finish

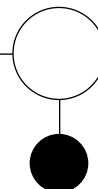

Felt Handle +34

01	BLACK
02	ANTHRACITE
03	STEEL
04	LIGHT GRANITE
05	DARK NUTMEG
06	BARK
07	CAMEL
08	SANDSTONE

Leather Handle +67

01	BLACK WEST TAN
02	PEANUT WEST TAN
03	VEGETABLE TANNED

Option only available on Pouf Single

4. Upholstery

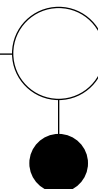

See **general information section** for details on textile program and COM information

Textiles are cut up the roll by default

Dau

LOUNGE

Textile Upholstery Grades

COM

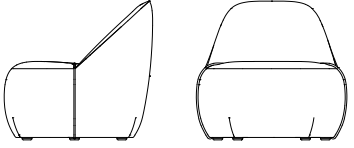
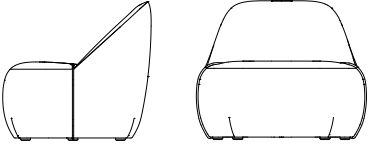
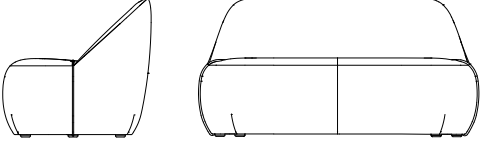
TITLE	SERIES	UNIT	TYPE	HEIGHT	DIMENSIONS	YDG	COM	A	B	C	D	E	F	G	H	I	J	K	L	M
 Lounge, Single	DU	1	101	6	31W x 30.5D x 28.25H	2.8	2,438	2,629	2,732	2,833	2,937	3,041	3,155	3,268	3,403	3,576	3,783	3,994	4,192	4,384
 Lounge, Single Plus	DU	1	151	6	35W x 30.5D x 28.25H	3.3	2,784	3,012	3,136	3,257	3,382	3,507	3,645	3,780	3,941	4,150	4,398	4,650	4,889	5,119
 Lounge, Double	DU	1	201	6	57W x 30.5D x 28.25H	6.1	3,866	4,286	4,514	4,736	4,963	5,192	5,444	5,692	5,988	6,369	6,826	7,289	7,725	8,147

To Order Select Below

1. Series/Model

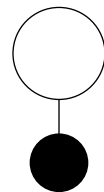

DU11016

Lounge
Single
Lounge Seat Height

DU11516

Lounge
Single Plus
Lounge Seat Height

DU12016

Lounge
Double
Lounge Seat Height

2. Glides

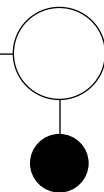

Glides

PG PLASTIC GLIDE

RG RUBBER GLIDE +14

FG FELT GLIDE +19

3. Upholstery

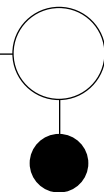

See general information section for details on textile program and COM information

Textiles are cut up the roll by default

Dau

POUF WITH CASTERS

Textile Upholstery Grades

COM

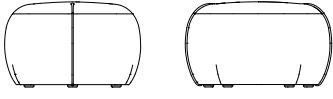
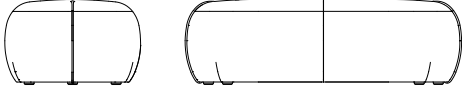
TITLE	SERIES	UNIT	TYPE	HEIGHT/CASTERS	DIMENSIONS	YDG	COM	A	B	C	D	E	F	G	H	I	J	K	L	M	
Pouf, Single, Caster	DU	0	101	3SLBS	30W x 28D x 15.75H	2.0	1,647	1,781	1,853	1,923	1,997	2,069	2,149	2,228	2,322	2,444	2,589	2,736	2,875	3,009	
																					
Pouf, Double, Caster	DU	0	201	3SLBS	44W x 28D x 15.75H	3.6	2,656	2,905	3,038	3,170	3,305	3,440	3,589	3,736	3,910	4,136	4,406	4,679	4,937	5,186	
																					

To Order Select Below

1. Series/Model

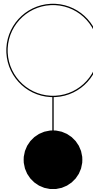

DU01013

**Pouf
Single Caster
Lounge Seat Height**

DU02013

**Pouf
Double Caster
Lounge Seat Height**

2. Caster

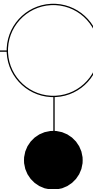

Caster

SLBS

SELF-LOCKING BLACK
WHEEL SOFT WHEEL
CASTER

3. Handle Finish

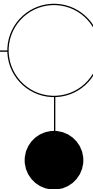

Felt Handle

01 BLACK

02 ANTHRACITE

03 STEEL

04 LIGHT GRANITE

05 DARK NUTMEG

06 BARK

07 CAMEL

08 SANDSTONE

Leather Handle +34

01 BLACK WEST TAN

02 PEANUT WEST TAN

03 VEGETABLE TANNED

4. Upholstery

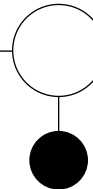

**See general
information section
for details on textile
program and
COM information**

**Textiles are cut up
the roll by default**

Dau

LOUNGE WITH CASTERS

Textile Upholstery Grades

COM

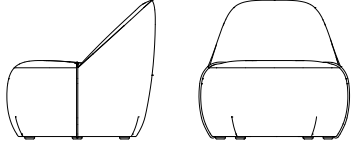
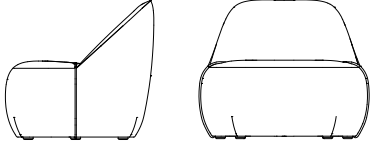
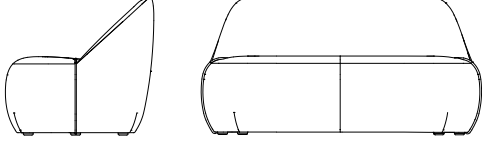
TITLE	SERIES	UNIT	TYPE	HEIGHT/CASTERS	DIMENSIONS	YDG	COM	A	B	C	D	E	F	G	H	I	J	K	L	M
 Lounge, Single, Caster	DU	1	101	6SLBS	31W x 30.5D x 28.25H	2.8	2,571	2,762	2,865	2,966	3,070	3,174	3,288	3,401	3,536	3,709	3,916	4,127	4,325	4,517
 Lounge, Single Plus, Caster	DU	1	151	6SLBS	35W x 30.5D x 28.25H	3.3	2,917	3,145	3,269	3,390	3,515	3,640	3,778	3,913	4,074	4,283	4,531	4,783	5,022	5,252
 Lounge, Double, Caster	DU	1	201	6SLBS	57W x 30.5D x 28.25H	6.1	3,999	4,419	4,647	4,868	5,096	5,325	5,577	5,825	6,121	6,502	6,959	7,422	7,858	8,280

To Order Select Below

1. Series/Model

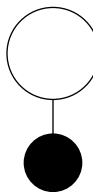

DU11016

**Lounge
Single Caster
Lounge Seat Height**

DU11516

**Lounge
Single Plus Caster
Lounge Seat Height**

DU12016

**Lounge
Double Caster
Lounge Seat Height**

2. Caster

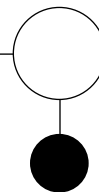

Caster

SLBS

SELF-LOCKING BLACK
WHEEL SOFT WHEEL
CASTER

3. Handle Finish

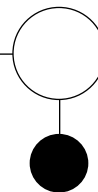

Felt Handle

01 BLACK

02 ANTHRACITE

03 STEEL

04 LIGHT GRANITE

05 DARK NUTMEG

06 BARK

07 CAMEL

08 SANDSTONE

Leather Handle +34

01 BLACK WEST TAN

02 PEANUT WEST TAN

03 VEGETABLE TANNED

4. Upholstery

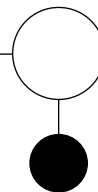

**See general
information section
for details on textile
program and
COM information**

**Textiles are cut up
the roll by default**

Dau

WIRE TABLE

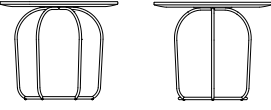
TITLE	SERIES	UNIT	TYPE	DIMENSIONS	PRICE
Tables, Wire Table Small 	DU	5	01	15.75D x 21.3H	1,174
Tables, Wire Table Medium 	DU	5	02	22.9D x 20.9H	1,447

To Order Select Below

1. Series/Model

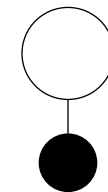

DU501

**Wire Table
Small**

DU502

**Wire Table
Medium**

2. Frame Finish

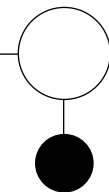

Standard Powder Coated Metal

BL	BLUE
BM	BLACK MATTE
BR	BRASS
BT	BLACK TWILIGHT
CP	CHAMPAGNE
DB	DARK BRONZE
DG	DARK GRAY
DP	DUSTY PINK
FG	FOREST GREEN
LG	LIGHT GRAY
MG	MEADOW GREEN
MK	MILK
MS	METALLIC SILVER

Chrome +256

CH BRIGHT CHROME

Satin Chrome +382

SC SATIN CHROME

3. Top Finish

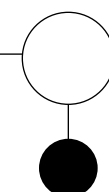

Top Finish

Small Medium

SW81	WHITE OAK	+69	+148
SW83	NATURAL MAPLE	+69	+148
SW85	WALNUT	+200	+435
SW87	OPAQUE BLACK		

Dau

UPHOLSTERED TABLE

Textile Upholstery Grades

TITLE	SERIES	UNIT	TYPE	DIMENSIONS	YDG	COM													
						A	B	C	D	E	F	G	H	I	J	K	L	M	
Tables, Upholstered Table Large	DU	5	03	32D x 17.13H	2.0	2,218	2,351	2,423	2,494	2,567	2,640	2,720	2,798	2,893	3,015	3,159	3,306	3,445	3,579

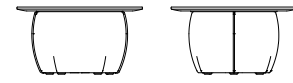

To Order Select Below

1. Series/Model

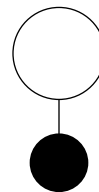

DU503

Upholstered Table Large

2. Glides

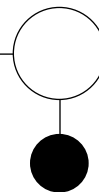

Glides

PG	PLASTIC GLIDE	
RG	RUBBER GLIDE	+14
FG	FELT GLIDE	+19

3. Top Finish

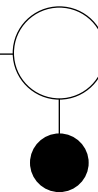

Top Finish

SW81	WHITE OAK	+263
SW83	NATURAL MAPLE	+263
SW85	WALNUT	+762
SW87	OPAQUE BLACK	

4. Upholstery

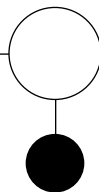



See **general information section** for details on textile program and **COM** information

Textiles are cut up the roll by default

Dau

TABLET ARM

TITLE	SERIES	UNIT	TYPE	HEIGHT	DIMENSIONS	PRICE													
 Tables, Tablet Arm, Pouf Lounge Height	DU	5	04	3	14D x 25H	887													
 Tables, Tablet Arm, Lounge Height	DU	5	04	6	14D x 26.5H	887													

To Order Select Below

1. Series/Model

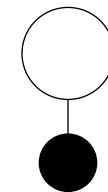

DU5043

**Tablet Arm,
Pouf Lounge Height**

DU5046

**Tablet Arm,
Lounge Height**

2. Frame Finish

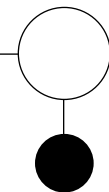

Standard Powder Coated Metal

- BL BLUE
- BM BLACK MATTE
- BR BRASS
- BT BLACK TWILIGHT
- CP CHAMPAGNE
- DB DARK BRONZE
- DG DARK GRAY
- DP DUSTY PINK
- FG FOREST GREEN
- LG LIGHT GRAY
- MG MEADOW GREEN
- MK MILK
- MS METALLIC SILVER

Chrome +90

CH BRIGHT CHROME

3. Top Finish

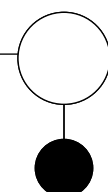

Top Finish

- SW81 WHITE OAK **+54**
- SW83 NATURAL MAPLE **+54**
- SW85 WALNUT **+154**
- SW87 OPAQUE BLACK

stylex

Dela

PRICE LIST

Effective November 01, 2023

General Information

GENERAL INFORMATION

Terms

Net 30 days from date of invoice.
FOB Delanco, NJ

Damaged Shipments

All Stylex products are carefully inspected before they are packed in sturdy cartons designed to satisfy shipping requirements. Stylex is not responsible for damage in shipment. The transportation company assumes responsibility for delivering products to you in good condition when the bill of lading is signed. You protect yourself by refusing shipments showing damage or shortage until transportation company has noted on the delivery sheet the extent of damage or shortage. Concealed damage should be reported to the carrier as soon as discovered, but not later than 15 days after receiving shipment.

Return/Restocking Policy

Return shipments will not be accepted unless specifically authorized by Stylex in writing. The Return Authorization number should be clearly marked on the carton. The customer returning Stylex products is responsible for return shipping costs. Merchandise must be returned unused. Returned merchandise is subject to a 35% restocking fee.

Specials/Customs

Modifications to standard products will be considered for large runs. Contact Stylex for more information.

Design Changes

In keeping with modern manufacturing advances, Stylex reserves the right to incorporate minor modifications and design changes in products without notice.

Cancellation Policy

No charge prior to production except for inventory specifically requisitioned to fulfill the particular order. After production has begun, only actual costs incurred, including labor and material, will be billed to the customer.

WARRANTY

Except as provided below, Stylex warrants exclusively to the original Purchaser of our product that all parts, under normal use and service, will be free from defects in workmanship and material for a period of ten (10) years from the date of purchase. "Normal use and service" means that the product will be used in a typical office environment for 40-45 hours per week.

This warranty is subject to the following limitations, exclusions and provisions:

Wood components of plywood stacking chairs
(such as Brooks and Welcome)
5 years

Upholstery
(including mesh used for Click, F4, Insight, and Zephyr Mesh)
3 years

SAVA Mesh
10 years

COM Upholstery
No warranty
Stylex makes every effort to ensure that the COM Upholstery it approves is suitable for the intended use. Nevertheless, we will not warrant, and assume no responsibility for, the durability or tailoring quality of any COM or COL. If you have any concerns about the ultimate appearance of any covering, please order an upholstered sample.

Painted Stack Chair Frames
No Warranty
We will not warrant the finish of painted stack chair frames against damage from stacking. We recommend ordering chrome frames for chairs that will be stacked.

Felt Glides
No warranty
Due to the different surfaces on which felt glides may be used, we cannot warrant their durability over time.

If this product fails during normal use and service within the applicable warranty period (other than through normal wear and tear), please send a description of the relevant part and the nature of the defect, together with proof of purchase of the product, to Stylex at: Customer Service. c/o Stylex, P.O. Box 5038, Delanco, NJ 08075. PLEASE DO NOT RETURN PARTS OR THE PRODUCT TO STYLEX UNLESS INSTRUCTED TO DO SO BY STYLEX. Stylex will, at its option, either repair or replace the product or the part found defective by Stylex completely without charge for materials or labor. Purchaser may be required (at the option of Stylex) to return to Stylex at Purchaser's expense any defective part with all freight or shipping charges prepaid. The foregoing warranty shall be void if the product has been altered or repaired (other than by Stylex). The warranty does not cover damage to the product caused by accident, neglect, misuse, abuse, modification to the product by anyone other than Stylex or damage caused by use of the product for a purpose other than that for which it was designed. This warranty extends only to the original Purchaser of the product.

No Other Warranties

This warranty is in lieu of all other warranties, expressed or implied, including, but not limited to, implied warranties of merchantability and fitness for a particular purpose. The rights and remedies provided herein are the exclusive rights and remedies of the original purchaser of the product.

No Liability For Damages

In no event shall Stylex or its suppliers be responsible or liable for any special, indirect, consequential, or incidental damages. In no event shall the liability of Stylex exceed the actual purchase price paid to Stylex for the product.

Out of Warranty Products

For all products no longer covered by our warranty, please refer to our Design for Durability and Upgradability Policy. Contact Customer Service if you would like to purchase any replaceable components to further extend the life of any Stylex seating product. This warranty applies to all Stylex products purchased on April 13, 2018, and thereafter.

PRODUCT TAKE BACK PROGRAM

At Stylex, responsible stewardship of our products extends beyond their initial use. Our Product Take Back Program provides a practical solution for the end of our products' intended life cycle.

Through our partnership with ANEW, a 501(c)(3) nonprofit organization, we offer clients a comprehensive take-back solution for surplus office furniture and materials, regardless of their condition. ANEW's mission aligns with ours—to connect surplus resources with non-profits, public agencies, and underserved communities, minimizing landfill impact and maximizing corporate social responsibility.

By repurposing surplus items, we strengthen community networks and reduce environmental impact. Stylex proudly supports ANEW, integrating this partnership into our strategic sales strategy since 2014. Learn more at www.anewfound.org.

Initiate a Product Take Back through ANEW by emailing Stylex at info@stylexdesign.com. For additional end-of-life recovery options, refer to our Product Disassembly Instructions and End of Life Recovery Options documents, available in the Resources section of each product on our website. Together, let's build a sustainable future.

FREIGHT PROGRAM

Stylex offers a Guaranteed Freight Program, which provides the purchaser the ability to determine shipping and handling charges at the time of order. Freight charges will be calculated as a percentage of the net product price and added to the invoice at the time of shipment. The continental United States has been divided into three zones. Please use the map below to determine the freight charges for the product's destination. There is a minimum freight charge of \$150.

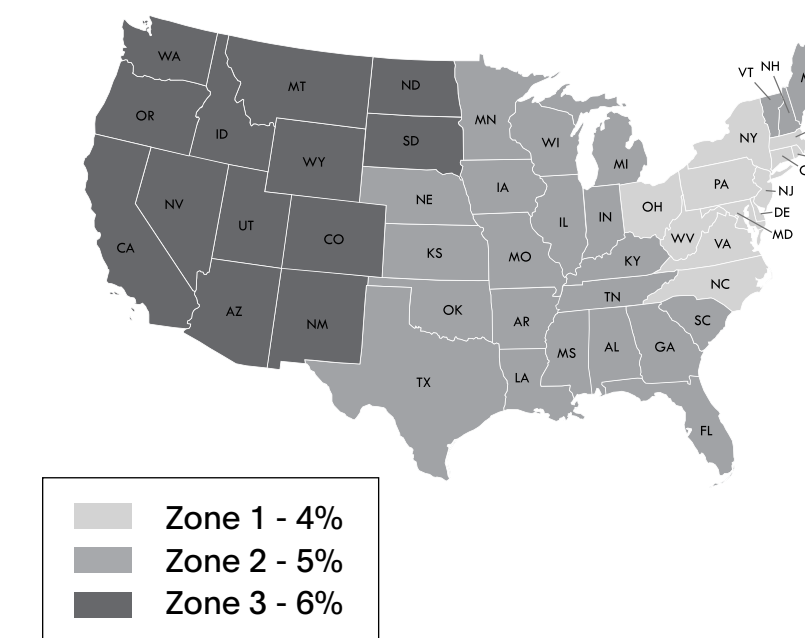

ZONE 1 - 4%

Connecticut
Delaware
New York
New Jersey
Maryland
Massachusetts
North Carolina
Ohio
Pennsylvania
Rhode Island
Virginia
Washington D.C.
West Virginia

ZONE 2 - 5%

Alabama
Arkansas
Canada, Ontario
Canada, Quebec
Florida
Georgia
Iowa
Illinois
Indiana
Kansas
Kentucky
Louisiana
Nebraska
New Hampshire
Oklahoma
Maine
Michigan
Minnesota
Mississippi
South Carolina
Tennessee
Texas
Vermont
Wisconsin

ZONE 3 - 6%

Arizona
California
Colorado
Idaho
Montana
Nevada
New Mexico
North Dakota
Oregon
South Dakota
Utah
Washington
Wyoming

Quote Per Project

Alaska
Hawaii
Canada
(outside Ontario & Quebec)
Mexico

General Information

TEXTILE PARTNERS & APPROVALS

Textile Partners

To customize your furniture performance needs and design vision, Stylex offers a wide selection of in-graded leathers and textiles from Grades A through Y. We've partnered with leading manufacturers on the options, focusing on color, price, durability, and construction. To view our partners and explore our digital carded program with broadly approved textiles, visit [this page](#). We stand by these textiles: They're tried and tested, and will effortlessly fit into any design aesthetic.

Textile Approvals

To view Stylex Approved Textile documents to determine specific product approval status, refer to our Product Tested Textiles documents, available in the Resources section of each product on our website.

CAL 117 AND 133 COMPLIANCE

CAL 117-2013

All Stylex seating satisfies the requirements of CAL 117-2013 so long as one of our standard or in-graded textiles is applied. COM textiles cannot be so guaranteed. Please contact the supplier of COM's directly to determine the fire retardancy of any COM supplied to us.

CAL 133

Most Stylex seating can be ordered to meet the requirements of CAL 133. When ordering, simply specify "CAL 133 compliance required". The upcharge for this option is \$54 list per yard. Please refer to the COM yardage of each model to determine the number of yards required. We do frequently require full-scale burn tests in order to certify CAL 133 before an order will be accepted. Such burn tests may increase normal lead times and do carry additional charges. Please contact customer service for details.

CUSTOMER'S OWN MATERIAL/LEATHER

Customer's own material (COM) and customer's own leather (COL) will generally be upholstered at the price designated in each product's price list. Please be advised, however, that we specifically reserve the right to charge a higher price when we determine that special circumstances, such as unusual repeats or challenging materials, present themselves. All orders for custom coverings must be approved by Stylex before they will be accepted for production. To submit proposed textile for approval, please use the COM form [here](#).

Special Note:

We assume no responsibility for the durability or tailoring quality of any COM or COL. Directional covers in particular may not meet your satisfaction due to the design of certain products. Please be advised that COM and COL orders are not subject to return. If you have doubts about the ultimate appearance of certain coverings, please order a sample done with that specific COM or COL. In addition, while we inspect textiles for mill imperfections, some are difficult to recognize. We cannot be responsible for defects, color inaccuracies, dye lot variations, or other flaws.

Under no circumstances will we be responsible for COM shortages, flaws, or other such problems. Finally, it is not our responsibility to police the receipt of COM's in order to meet delivery deadlines, and we assume our customers are aware of any undue delay in the shipment of their COM textiles.

COM textile and COL leather should be sent prepaid to: Stylex

**Attn: COM/COL - [Your PO #]
740 Coopertown Road
Delanco, NJ 08075**

Clearly mark textile or leather with the dealer's name, purchase order number, and furniture model number of the item to be covered. Actual furniture orders should include the same information, as well as a description of the textile or leather, including pattern and color number, in order to provide a cross reference.

Yardage requirements shown in the price list are based on non-directional goods of 54" width. Textiles less than 54" wide or those requiring matching (stripes, prints, or large patterned designs) call for additional yardage. We will be happy to supply yardage requirements for large quantities where economies may be realized.

Add the following yardage for stripes, plaids, or patterns with repeats:

Textile Width	Plain Textile	2-14" Repeat	15-24" Repeat	25-27" Repeat	28-36" Repeat
54"	0%	10%	15%	20%	25%
50"	10%	20%	25%	30%	35%
48"	15%	25%	30%	35%	40%
45"	40%	50%	55%	60%	65%
36"	50%	60%	65%	70%	75%

COM/COL FORM

To avoid delay in processing COM orders we request that you submit a sample of your COM textile stapled to this form which can be downloaded [here](#). If a textile has a stripe or design, the size of the repeat should be indicated. Please indicate the textile supplier's name, textile number, and color. Also indicate the Stylex product on which the textile will be used.

The textile supplier must indicate on his shipping labels the dealer name and purchase order number as well as the Stylex model number.

Please Note:

No order may be entered into production or have a shipping date assigned until all related COM is received at the factory.



CENTER OF STRIPE OR DESIGN

TOP	TOP
-----	-----

1. Size of Repeat

2. Textile Supplier

3. Textile Number

4. Color

5. Stylex Product

Contents

<hr/>		<hr/>	
COLORS, MATERIALS, AND FINISHES	5	GUEST	9
<hr/>		<hr/>	
STATEMENT OF LINE	6	TASK 4-BLADE CASTER	11
<hr/>		<hr/>	
DIMENSIONS	7	STOOL	12
<hr/>		<hr/>	
HOW TO ORDER	8	LOUNGE	14
<hr/>		<hr/>	

CLICK THE TITLES ABOVE TO NAVIGATE THROUGH THE DOCUMENT
PRODUCT HEADERS ON SUBSEQUENT PAGES LINK BACK TO THIS PAGE

Dela

COLORS, MATERIALS, AND FINISHES

POWDER COAT & METAL LEG FINISH

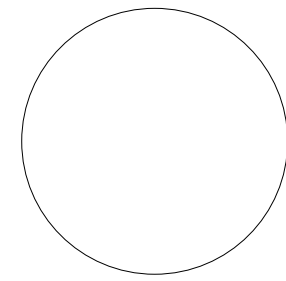

MILK
(MK)

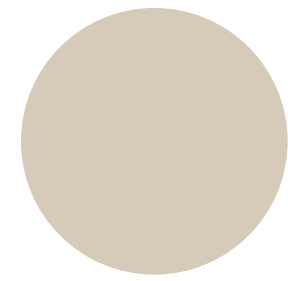

SAND
(SD)

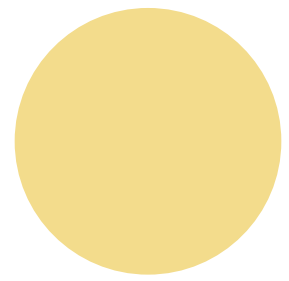

PALE YELLOW
(PY)

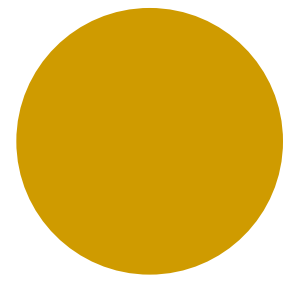

YELLOW
(YL)

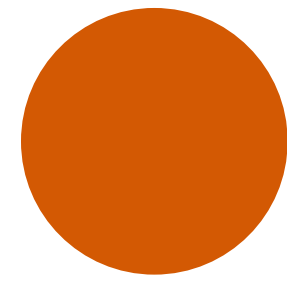

ORANGE
(OR)

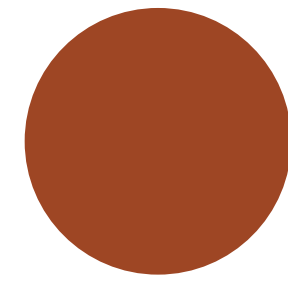

TERRACOTTA
(TC)

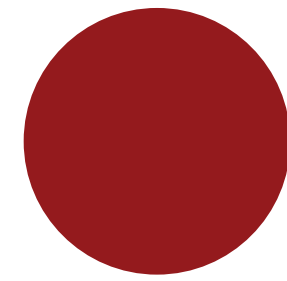

RED
(RD)

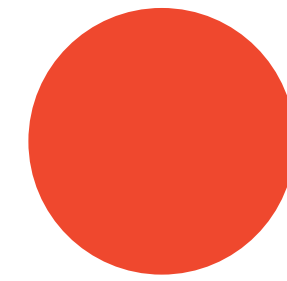

RED ORANGE
(RO)

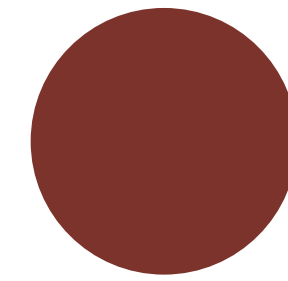

RUSTY RED
(RR)

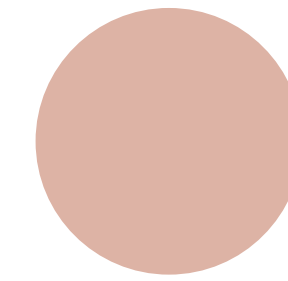

DUSTY PINK
(DP)

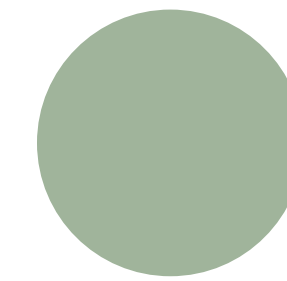

MEADOW GREEN
(MG)

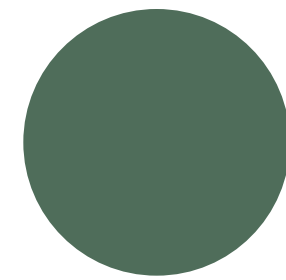

FOREST GREEN
(FG)

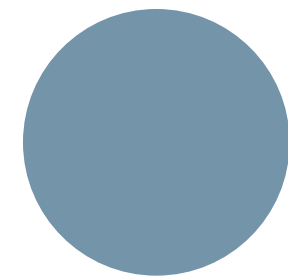

SOFT BLUE
(SB)

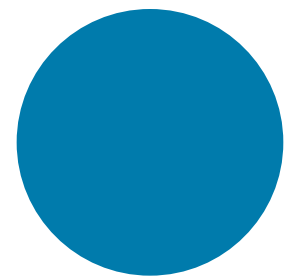

BLUE
(BL)

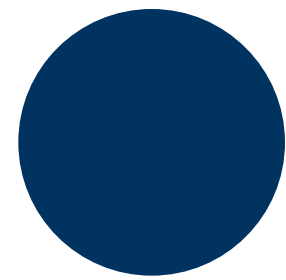

NAVY
(NV)

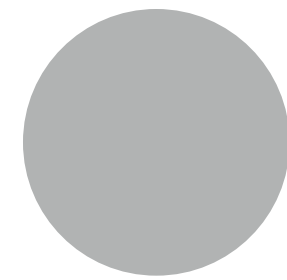

LIGHT GRAY
(LG)



CHAMPAGNE
(CP)

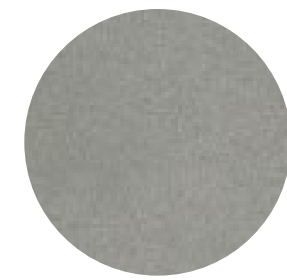

METALLIC SILVER
(MS)

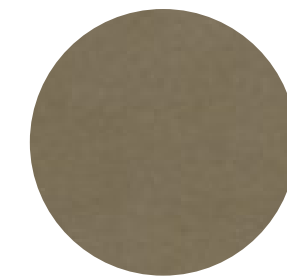

NICKEL
(NK)

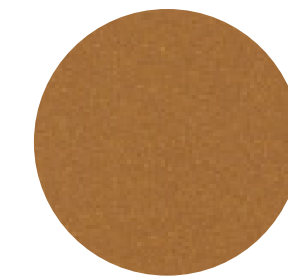

BRASS
(BR)

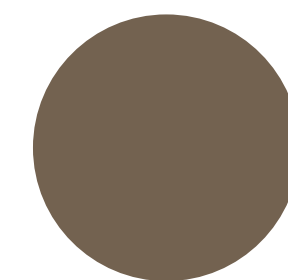

TAUPE
(TP)

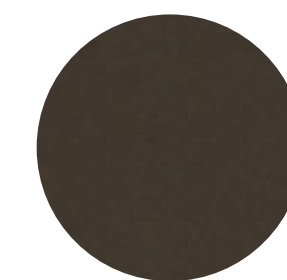

DARK BRONZE
(DB)

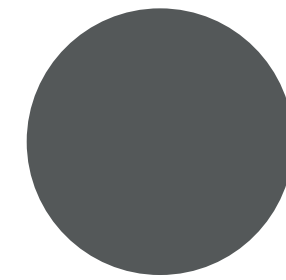

DARK GRAY
(DG)

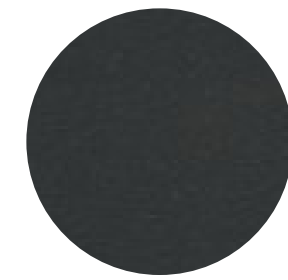

TEXTURED SLATE
(TS)

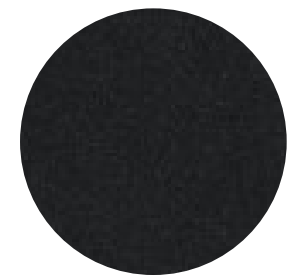

BLACK TWILIGHT
(BT)

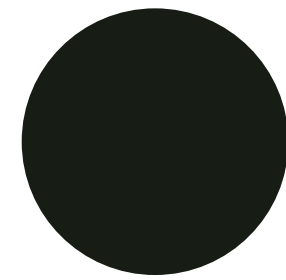

BLACK MATTE
(BM)

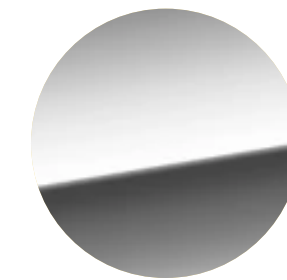

BRIGHT CHROME
(CH)

WOOD SHELL



ALPI-RIFT
CUT OAK
(PZ30)



TONED
WALNUT
(PZ20)

WOOD ARM CAP



WHITE OAK
(81)



TONED
WALNUT
(89)

Dela

SPECIFICATION GUIDE: STATEMENT OF LINE

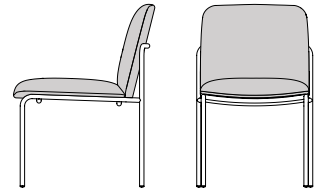
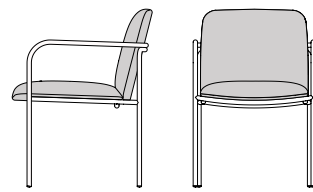
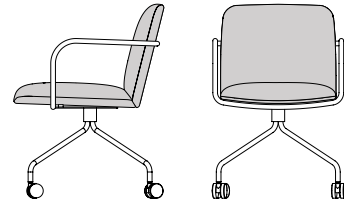
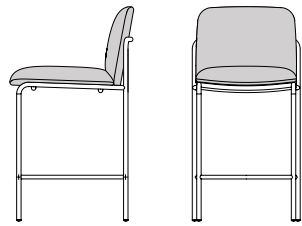
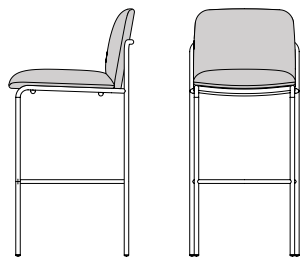
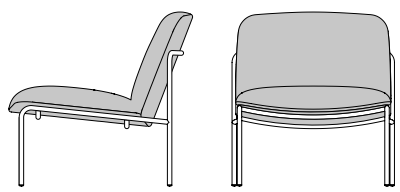
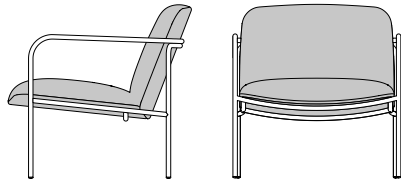
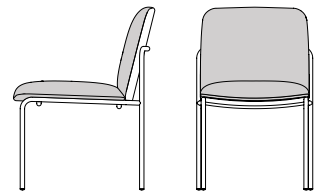
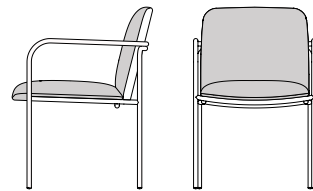
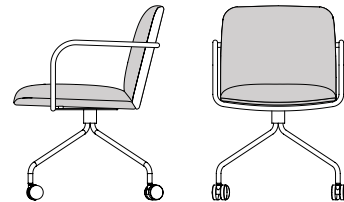
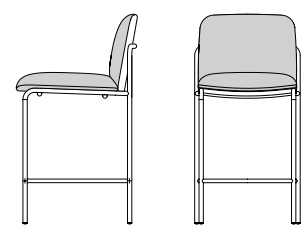
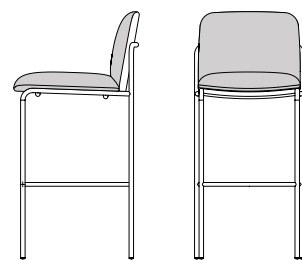
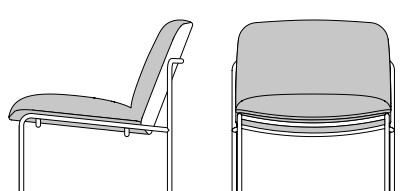
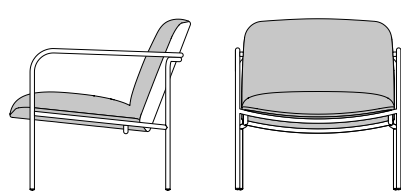
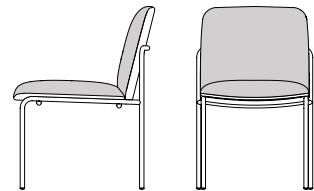
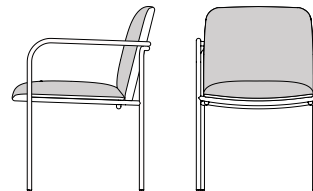
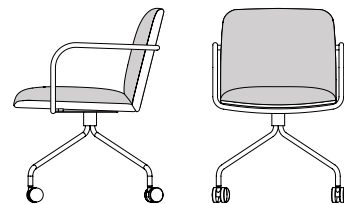
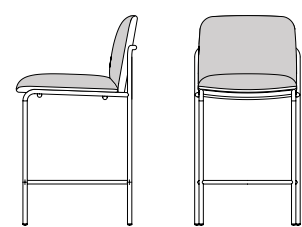
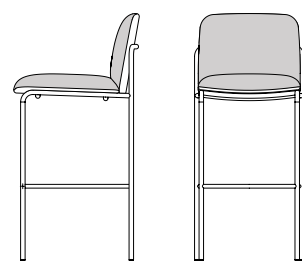
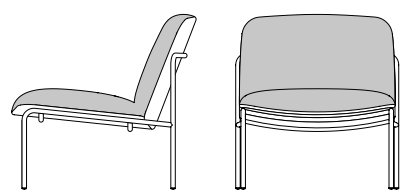
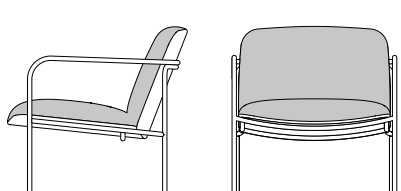
OVERVIEW	GUEST		TASK	STOOL		LOUNGE	
	4-LEG ARMLESS	4-LEG ARM	4-BLADE CASTER	COUNTER	BAR	4-LEG ARMLESS	4-LEG ARM
Fully Upholstered							
Finished Wood Back							
Finished Wood Back and Seat							

OPTIONS

Styles & Wood Finishes	Fully Upholstered 	Finished Wood Back 	Finished Wood Back and Seat 	Plywood Back/Seat Toned Walnut 	Plywood Back/Seat Alpi-Rift Cut Oak 	Solid Wood Arm Cap Toned Walnut 	Solid Wood Arm Cap Oak 	
Upholstery	Welt (Back & Seat) 	Button Tuft (Back Only) 	Liberty Tuft (Back Only) 	Dual Upholstery - 1 Inside (Yellow), 2 Outside (Gray) 				

PRODUCT INFORMATION

Design

Stylex/Brandon Walker

Construction

Seats and backs consist of curved upholstery grade or finished plywood. Upholstered interior liners consist of foam over plywood. Frames are constructed out of round steel tubing. Arm caps are offered in finished grade wood or upholstered constructed of foam and wood.

Wood Finishes

The beauty of wood lies in its natural grain patterns, which are unique to each piece of wood. As such, exposed wood surfaces will not offer the same consistency as man-made materials. Some variation in color, grain, and texture are to be expected, even within the same order. Another consideration is that wood components will tend to darken over time, exaggerating slightly naturally occurring differences.

Glides

Plastic and felted glides come in black or light gray.

Casters

Casters are available in black or light gray.

Use

Designed for indoor use only.

Performance Standards

Manufactured to comply with:
ANSI/BIFMA X5.1 General-Purpose Office Chairs - Tests

Certifications

Greenguard Gold
LEVEL® 1

Dela

SPECIFICATION GUIDE: DIMENSIONS

OVERVIEW

Dimensions

- A. Seat Height
- B. Seat Depth
- C. Seat Width
- D. Back Height
- E. Back Width
- F. Overall Width
- G. Maximum Overall Height
- H. Maximum Overall Depth

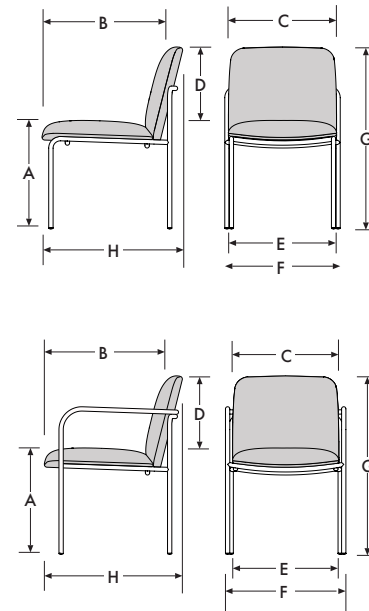

4-Leg Armless Guest

- A. 18
- B. 17.75
- C. 18.5
- D. 13
- E. 18.5
- F. 19.75
- G. 32.5
- H. 24

4-Leg Arm Guest

- A. 18
- B. 17.75
- C. 18.5
- D. 13
- E. 18.5
- F. 21
- G. 32.5
- H. 24

4-Blade Caster

- A. 18
- B. 17.75
- C. 18.5
- D. 13
- E. 18.5
- F. 21
- G. 32.5
- H. 24

Counter Stool

- A. 25.5
- B. 16.5
- C. 17
- D. 10.5
- E. 17
- F. 18.25
- G. 36.25
- H. 19.75

Bar Stool

- A. 30.5
- B. 16.5
- C. 17
- D. 10.5
- E. 17
- F. 18.25
- G. 41.25
- H. 19.75

4-Leg Armless Lounge

- A. 17.5
- B. 20.5
- C. 26
- D. 14.5
- E. 26
- F. 27.25
- G. 29
- H. 27.5

4-Leg Arm Lounge

- A. 17.5
- B. 20.5
- C. 26
- D. 14.5
- E. 26
- F. 29
- G. 29
- H. 27.5

Arm

- A. Max Width
- B. Arm Distance
- C. Arm Height

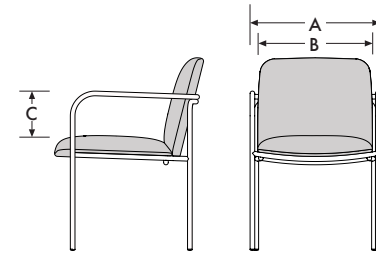

4-Leg Arm Guest

- A. 21
- B. 19.5
- C. 7.5

4-Blade Caster

- A. 21
- B. 19.5
- C. 7.5

4-Leg Arm Lounge

- A. 28.25
- B. 26.75
- C. 7.5

Arm with Arm Caps

- A. Max Width
- B. Arm Distance
- C. Arm Height

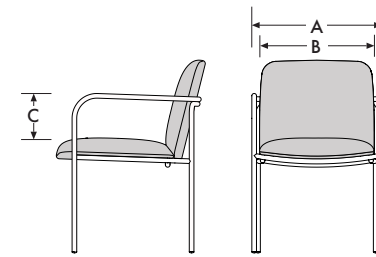

4-Leg Arm Guest

- A. 22.5
- B. 18.75
- C. 8

4-Blade Caster

- A. 22.5
- B. 18.75
- C. 9

4-Leg Arm Lounge

- A. 30.5
- B. 26
- C. 8

Dela

SPECIFICATION GUIDE: HOW TO ORDER

MODEL CODE BREAKDOWN

Sample Model Code: DL251B1BCUCBMCOM

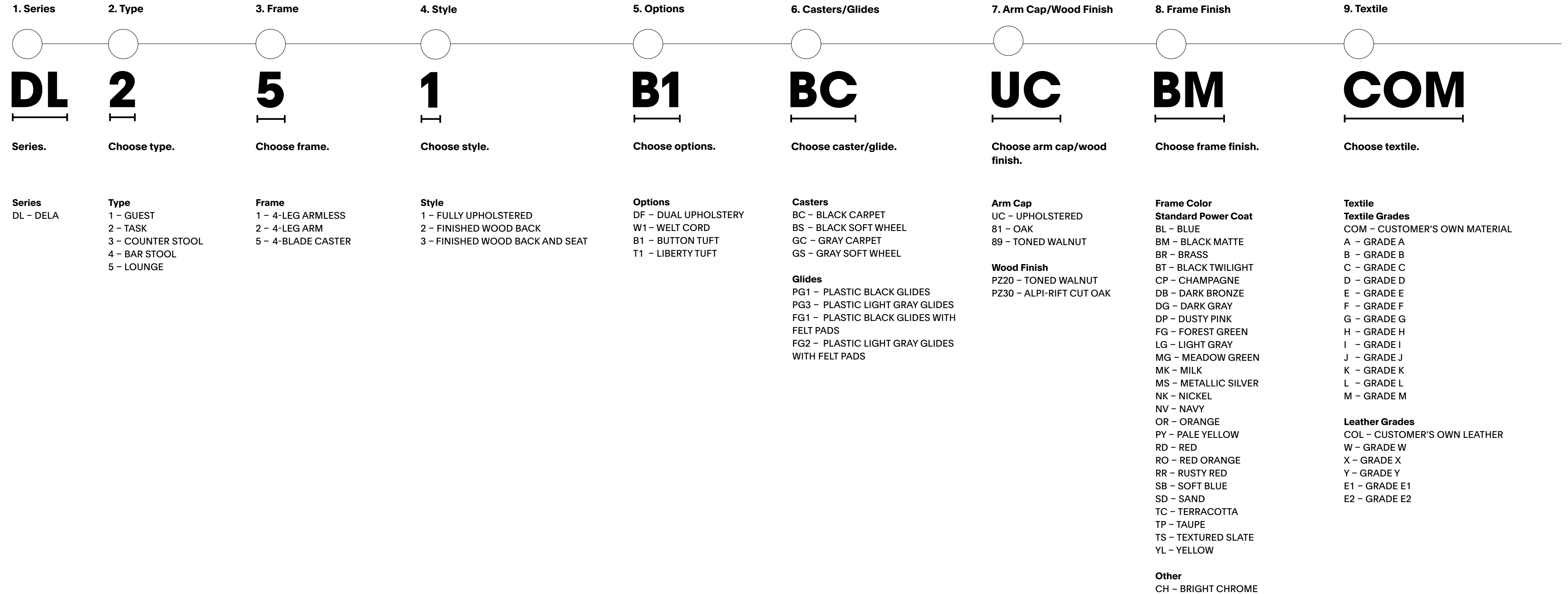

Dela

GUEST 4-LEG: ARMLESS

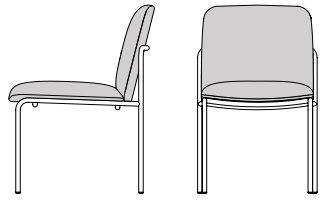
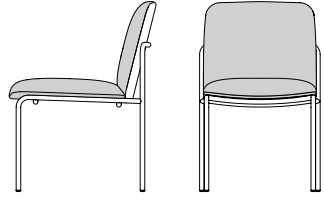
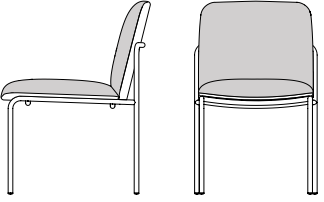
TITLE	SERIES	FRAME	ARM	STYLE	DIMENSIONS	COM	COL	Textile Upholstery Grades													Leather Upholstery Grades					
								YDG	SQFT	COM	A	B	C	D	E	F	G	H	I	J	K	L	M	W	X	Y
 Chair, Guest 4-Leg Armless, Fully Upholstered	DL	1	1	1	19.75W x 24D x 32.5H	1.7	26.5	1,028	1,152	1,220	1,285	1,352	1,421	1,494	1,569	1,655	1,767	1,903	2,036	2,171	2,306	1,791	1,961	2,617	3,025	3,409
 Chair, Guest 4-Leg Armless, Finished Wood Back	DL	1	1	2	19.75W x 24D x 32.5H	1.7	20.7	1,399	1,523	1,591	1,655	1,723	1,791	1,866	1,938	2,025	2,138	2,273	2,407	2,542	2,676	2,024	2,158	2,670	2,990	3,292
 Chair, Guest 4-Leg Armless, Finished Wood Back and Seat	DL	1	1	3	19.75W x 24D x 32.5H	0.9	17.3	1,676	1,742	1,779	1,813	1,849	1,886	1,926	1,965	2,011	2,071	2,143	2,214	2,286	2,357	2,220	2,331	2,758	3,025	3,276

To Order Select Below

1. Series/Type/Frame/Style

DL111	DELA GUEST 4-LEG ARMLESS FULLY UPHOLSTERED
DL112	DELA GUEST 4-LEG ARMLESS FINISHED WOOD BACK
DL113	DELA GUEST 4-LEG ARMLESS FINISHED WOOD BACK AND SEAT

Contact Customer Service for custom contrasting upholstery details.

2. Options

Upholstery Options		
B1	BUTTON TUFT	+27
T1	LIBERTY TUFT	+71
WC	WELT CORD	+79
Welt cord is required with leather upholstery and already captured in list pricing above. Welt cord upcharge is only applicable for fabrics. Welt cord is available for all styles.		
DF	DUAL UPHOLSTERY	
	INSIDE	0.8 YDS
	OUTSIDE	0.7 YDS

When specifying in-graded fabrics, please apply the higher of the two grades. Dual Fabric only available on Fully Upholstered models. Welt Cord on Dual Fabric Models uses the Inside Textile.

3. Glides

Glide	
PG1	PLASTIC BLACK GLIDES
PG3	PLASTIC LIGHT GRAY GLIDES
FG1	PLASTIC BLACK GLIDES WITH FELT PADS
FG2	PLASTIC LIGHT GRAY GLIDES WITH FELT PADS

4. Wood Finish

Wood Finish	
PZ20	TONED WALNUT
PZ30	ALPI-RIFT CUT OAK

5. Frame Finish

Powder Coat					
BL	BLUE	LG	LIGHT GRAY	RO	RED ORANGE
BM	BLACK MATTE	MG	MEADOW GREEN	RR	RUSTY RED
BR	BRASS	MK	MILK	SB	SOFT BLUE
BT	BLACK TWILIGHT	MS	METALLIC SILVER	SD	SAND
CP	CHAMPAGNE	NK	NICKEL	TC	TERRACOTTA
DB	DARK BRONZE	NV	NAVY	TP	TAUPE
DG	DARK GRAY	OR	ORANGE	TS	TEXTURED SLATE
DP	DUSTY PINK	PY	PALE YELLOW	YL	YELLOW
FG	FOREST GREEN	RD	RED		
Chrome					
CH	CHROME				+276

6. Upholstery

See general information section for details on textile program and COM/COL information

Textiles are cut railroaded by default

Dela

GUEST 4-LEG: ARM

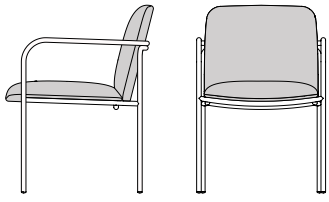
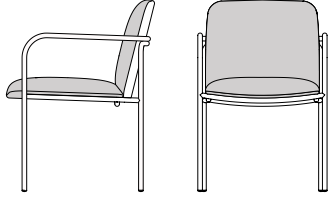
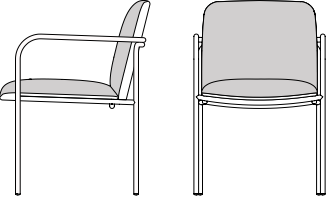
TITLE	SERIES	FRAME	ARM	STYLE	DIMENSIONS	COM	COL	Textile Upholstery Grades													Leather Upholstery Grades					
								YDG	SQFT	COM	A	B	C	D	E	F	G	H	I	J	K	L	M	W	X	Y
 Chair, Guest 4-Leg Arm, Fully Upholstered	DL	1	2	1	21W x 24D x 32.5H	1.7	26.5	1,083	1,205	1,274	1,340	1,407	1,475	1,549	1,623	1,710	1,822	1,958	2,091	2,226	2,359	1,846	2,016	2,670	3,080	3,464
 Chair, Guest 4-Leg Arm, Finished Wood Back	DL	1	2	2	21W x 24D x 32.5H	1.7	20.7	1,448	1,571	1,639	1,705	1,773	1,840	1,914	1,988	2,076	2,186	2,323	2,456	2,591	2,725	2,074	2,207	2,718	3,039	3,340
 Chair, Guest 4-Leg Arm, Finished Wood Back and Seat	DL	1	2	3	21W x 24D x 32.5H	0.9	17.3	1,721	1,787	1,824	1,859	1,894	1,931	1,971	2,010	2,056	2,116	2,187	2,260	2,331	2,402	2,265	2,376	2,804	3,070	3,321

To Order Select Below

1. Series/Type/Frame/Style

DL121	DELA GUEST 4-LEG ARM FULLY UPHOLSTERED
DL122	DELA GUEST 4-LEG ARM FINISHED WOOD BACK
DL123	DELA GUEST 4-LEG ARM FINISHED WOOD BACK AND SEAT

Contact Customer Service for custom contrasting upholstery details.

2. Options

Upholstery Options		
B1	BUTTON TUFT	+27
T1	LIBERTY TUFT	+71
WC	WELT CORD	+79
Welt cord is required with leather upholstery and already captured in list pricing above. Welt cord upcharge is only applicable for fabrics. Welt cord is available for all styles.		
DF	DUAL UPHOLSTERY	
	INSIDE	0.8 YDS
	OUTSIDE	0.7 YDS

When specifying in-graded fabrics, please apply the higher of the two grades. Dual Fabric only available on Fully Upholstered models. Welt Cord on Dual Fabric Models uses the Inside Textile.

3. Glides

Glide		
PG1	PLASTIC BLACK GLIDES	
PG3	PLASTIC LIGHT GRAY GLIDES	
FG1	PLASTIC BLACK GLIDES WITH FELT PADS	
FG2	PLASTIC LIGHT GRAY GLIDES WITH FELT PADS	

4. Arm Cap Finish

Arm Cap		
UC	UPHOLSTERED	+416
81	OAK	+318
89	TONED WALNUT	+334
Upholstered arm cap textiles default to match the seat components. When Dual Fabric is selected, the inside textile is the default.		

5. Wood Finish

Wood Finish		
PZ20	TONED WALNUT	
PZ30	ALPI-RIFT CUT OAK	

6. Frame Finish

Powder Coat					
BL	BLUE	LG	LIGHT GRAY	RO	RED ORANGE
BM	BLACK MATTE	MG	MEADOW GREEN	RR	RUSTY RED
BR	BRASS	MK	MILK	SB	SOFT BLUE
BT	BLACK TWILIGHT	MS	METALLIC SILVER	SD	SAND
CP	CHAMPAGNE	NK	NICKEL	TC	TERRACOTTA
DB	DARK BRONZE	NV	NAVY	TP	TAUPE
DG	DARK GRAY	OR	ORANGE	TS	TEXTURED SLATE
DP	DUSTY PINK	PY	PALE YELLOW	YL	YELLOW
FG	FOREST GREEN	RD	RED		
Chrome					
CH	CHROME				+389

7. Upholstery

See general information section for details on textile program and COM/COL information

Textiles are cut railroad by default

Dela

TASK 4-BLADE CASTER

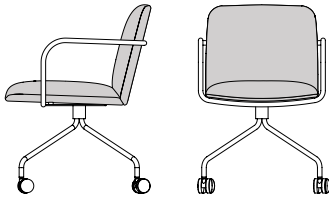
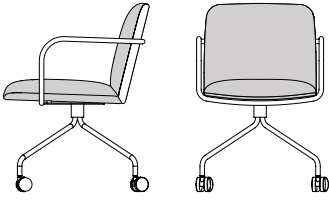
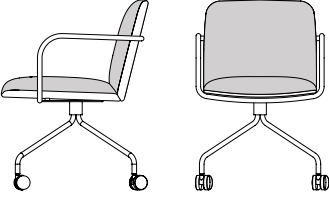
TITLE	SERIES	FRAME	ARM	STYLE	DIMENSIONS	YDG	SQFT	Textile Upholstery Grades													Leather Upholstery Grades					
								COM	COL	COM	A	B	C	D	E	F	G	H	I	J	K	L	M	W	X	Y
 Chair, Task 4-Blade Caster, Fully Upholstered	DL	2	3	1	21W x 24D x 32.5H	1.7	26.5	1,257	1,381	1,448	1,513	1,581	1,650	1,723	1,797	1,884	1,996	2,132	2,265	2,400	2,534	2,019	2,190	2,843	3,254	3,638
 Chair, Task 4-Blade Caster, Finished Wood Back	DL	2	3	2	21W x 24D x 32.5H	1.7	20.7	1,504	1,628	1,695	1,760	1,828	1,896	1,970	2,043	2,132	2,243	2,378	2,513	2,647	2,781	2,129	2,263	2,775	3,095	3,397
 Chair, Task 4-Blade Caster, Finished Wood Back and Seat	DL	2	3	3	21W x 24D x 32.5H	0.9	17.3	1,771	1,838	1,873	1,909	1,945	1,981	2,020	2,059	2,106	2,166	2,239	2,310	2,381	2,453	2,316	2,427	2,854	3,121	3,372

To Order Select Below

1. Series/Type/Frame/Style

DL231	DELA TASK 4-BLADE CASTER FULLY UPHOLSTERED
DL232	DELA TASK 4-BLADE CASTER FINISHED WOOD BACK
DL233	DELA TASK 4-BLADE CASTER FINISHED WOOD BACK AND SEAT

Contact Customer Service for custom contrasting upholstery details.

2. Options

Upholstery Options		
B1	BUTTON TUFT	+27
T1	LIBERTY TUFT	+71
WC	WELT CORD	+79
Welt cord is required with leather upholstery and already captured in list pricing above. Welt cord upcharge is only applicable for fabrics. Welt cord is available for all styles.		
DF	DUAL UPHOLSTERY	
	INSIDE	0.8 YDS
	OUTSIDE	0.7 YDS

When specifying in-graded fabrics, please apply the higher of the two grades. Dual Fabric only available on Fully Upholstered models. Welt Cord on Dual Fabric Models uses the Inside Textile.

3. Casters

Caster		
BC	BLACK CARPET	
BS	BLACK SOFT WHEEL	+37
GC	GRAY CARPET	+24
GS	GRAY SOFT WHEEL	+45

4. Arm Cap Finish

Arm Cap		
UC	UPHOLSTERED	+416
81	OAK	+318
89	TONED WALNUT	+334
Upholstered arm cap textiles default to match the seat components. When Dual Fabric is selected, the inside textile is the default.		

5. Wood Finish

Wood Finish		
PZ20	TONED WALNUT	
PZ30	ALPI-RIFT CUT OAK	

6. Frame Finish

Powder Coat					
BL	BLUE	LG	LIGHT GRAY	RO	RED ORANGE
BM	BLACK MATTE	MG	MEADOW GREEN	RR	RUSTY RED
BR	BRASS	MK	MILK	SB	SOFT BLUE
BT	BLACK TWILIGHT	MS	METALLIC SILVER	SD	SAND
CP	CHAMPAGNE	NK	NICKEL	TC	TERRACOTTA
DB	DARK BRONZE	NV	NAVY	TP	TAUPE
DG	DARK GRAY	OR	ORANGE	TS	TEXTURED SLATE
DP	DUSTY PINK	PY	PALE YELLOW	YL	YELLOW
FG	FOREST GREEN	RD	RED		
Chrome					
CH	CHROME				+389

7. Upholstery

See general information section for details on textile program and COM/COL information

Textiles are cut railroad by default

Dela

STOOL: COUNTER

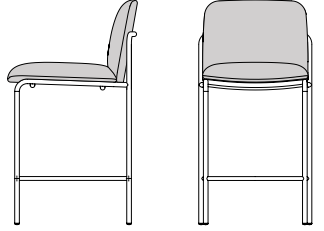
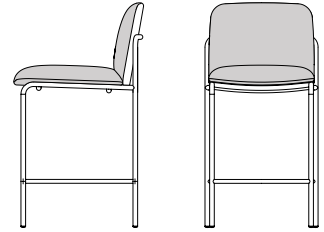
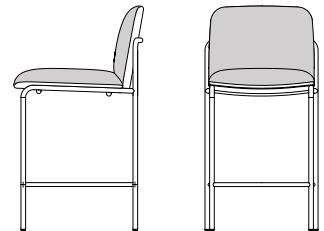
TITLE	SERIES	FRAME	ARM	STYLE	DIMENSIONS	COM	COL	Textile Upholstery Grades													Leather Upholstery Grades					
								YDG	SQFT	COM	A	B	C	D	E	F	G	H	I	J	K	L	M	W	X	Y
 Counter Stool, Fully Upholstered	DL	3	1	1	18.25W x 19.75D x 36.25H	1.7	26.5	1,234	1,349	1,412	1,474	1,537	1,601	1,670	1,739	1,821	1,925	2,051	2,175	2,301	2,426	1,887	2,029	2,568	2,906	3,225
 Counter Stool, Finished Wood Back	DL	3	1	2	18.25W x 19.75D x 36.25H	1.7	20.7	1,586	1,660	1,700	1,741	1,781	1,822	1,866	1,910	1,962	2,030	2,111	2,191	2,272	2,353	2,129	2,241	2,668	2,935	3,186
 Counter Stool, Finished Wood Back and Seat	DL	3	1	3	18.25W x 19.75D x 36.25H	0.9	17.3	2,001	2,067	2,103	2,139	2,175	2,210	2,250	2,289	2,336	2,395	2,469	2,540	2,611	2,683	2,463	2,552	2,894	3,107	3,308

To Order Select Below

1. Series/Type/Frame/Style

DL311	DELA COUNTER STOOL FULLY UPHOLSTERED
DL312	DELA COUNTER STOOL FINISHED WOOD BACK
DL313	DELA COUNTER STOOL FINISHED WOOD BACK AND SEAT

Contact Customer Service for custom contrasting upholstery details.

2. Options

Upholstery Options		
B1	BUTTON TUFT	+27
T1	LIBERTY TUFT	+71
WC	WELT CORD	+79
Welt cord is required with leather upholstery and already captured in list pricing above. Welt cord upcharge is only applicable for fabrics. Welt cord is available for all styles.		
DF	DUAL UPHOLSTERY	
	INSIDE	0.8 YDS
	OUTSIDE	0.7 YDS

When specifying in-graded fabrics, please apply the higher of the two grades. Dual Fabric only available on Fully Upholstered models. Welt Cord on Dual Fabric Models uses the Inside Textile.

3. Glides

Glide	
PG1	PLASTIC BLACK GLIDES
PG3	PLASTIC LIGHT GRAY GLIDES
FG1	PLASTIC BLACK GLIDES WITH FELT PADS
FG2	PLASTIC LIGHT GRAY GLIDES WITH FELT PADS

4. Wood Finish

Wood Finish	
PZ20	TONED WALNUT
PZ30	ALPI-RIFT CUT OAK

5. Frame Finish

Powder Coat					
BL	BLUE	LG	LIGHT GRAY	RO	RED ORANGE
BM	BLACK MATTE	MG	MEADOW GREEN	RR	RUSTY RED
BR	BRASS	MK	MILK	SB	SOFT BLUE
BT	BLACK TWILIGHT	MS	METALLIC SILVER	SD	SAND
CP	CHAMPAGNE	NK	NICKEL	TC	TERRACOTTA
DB	DARK BRONZE	NV	NAVY	TP	TAUPE
DG	DARK GRAY	OR	ORANGE	TS	TEXTURED SLATE
DP	DUSTY PINK	PY	PALE YELLOW	YL	YELLOW
FG	FOREST GREEN	RD	RED		
Chrome					
CH	CHROME				+389

6. Upholstery

See general information section for details on textile program and COM/COL information

Textiles are cut railroad by default

Dela

STOOL: BAR

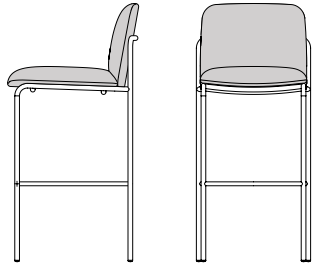
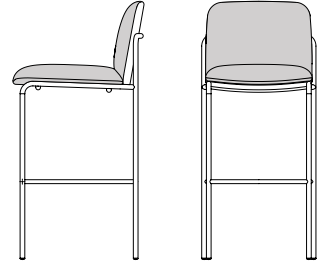
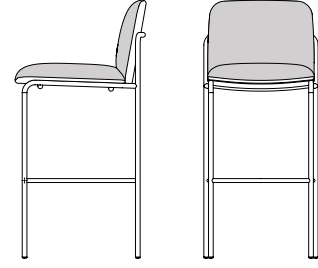
TITLE	SERIES	FRAME	ARM	STYLE	DIMENSIONS	COM	COL	Textile Upholstery Grades													Leather Upholstery Grades					
								YDG	SQFT	COM	A	B	C	D	E	F	G	H	I	J	K	L	M	W	X	Y
 Bar Stool, Fully Upholstered	DL	4	1	1	18.25W x 19.75D x 41.25H	1.7	26.5	1,234	1,349	1,412	1,474	1,537	1,601	1,670	1,739	1,821	1,925	2,051	2,175	2,301	2,426	1,887	2,029	2,568	2,906	3,225
 Bar Stool, Finished Wood Back	DL	4	1	2	18.25W x 19.75D x 41.25H	1.7	20.7	1,586	1,660	1,700	1,741	1,781	1,822	1,866	1,910	1,962	2,030	2,111	2,191	2,272	2,353	2,129	2,241	2,668	2,935	3,186
 Bar Stool, Finished Wood Back and Seat	DL	4	1	3	18.25W x 19.75D x 41.25H	0.9	17.3	2,001	2,067	2,103	2,139	2,175	2,210	2,250	2,289	2,336	2,395	2,469	2,540	2,611	2,683	2,463	2,552	2,894	3,107	3,308

To Order Select Below

1. Series/Type/Frame/Style

DL411	DELA BAR STOOL FULLY UPHOLSTERED
DL412	DELA BAR STOOL FINISHED WOOD BACK
DL413	DELA BAR STOOL FINISHED WOOD BACK AND SEAT

Contact Customer Service for custom contrasting upholstery details.

2. Options

Upholstery Options		
B1	BUTTON TUFT	+27
T1	LIBERTY TUFT	+71
WC	WELT CORD	+79
Welt cord is required with leather upholstery and already captured in list pricing above. Welt cord upcharge is only applicable for fabrics. Welt cord is available for all styles.		
DF	DUAL UPHOLSTERY	
	INSIDE	0.8 YDS
	OUTSIDE	0.7 YDS

When specifying in-graded fabrics, please apply the higher of the two grades. Dual Fabric only available on Fully Upholstered models. Welt Cord on Dual Fabric Models uses the Inside Textile.

3. Glides

Glide	
PG1	PLASTIC BLACK GLIDES
PG3	PLASTIC LIGHT GRAY GLIDES
FG1	PLASTIC BLACK GLIDES WITH FELT PADS
FG2	PLASTIC LIGHT GRAY GLIDES WITH FELT PADS

4. Wood Finish

Wood Finish	
PZ20	TONED WALNUT
PZ30	ALPI-RIFT CUT OAK

5. Frame Finish

Powder Coat					
BL	BLUE	LG	LIGHT GRAY	RO	RED ORANGE
BM	BLACK MATTE	MG	MEADOW GREEN	RR	RUSTY RED
BR	BRASS	MK	MILK	SB	SOFT BLUE
BT	BLACK TWILIGHT	MS	METALLIC SILVER	SD	SAND
CP	CHAMPAGNE	NK	NICKEL	TC	TERRACOTTA
DB	DARK BRONZE	NV	NAVY	TP	TAUPE
DG	DARK GRAY	OR	ORANGE	TS	TEXTURED SLATE
DP	DUSTY PINK	PY	PALE YELLOW	YL	YELLOW
FG	FOREST GREEN	RD	RED		
Chrome					
CH	CHROME	+389			

6. Upholstery

See general information section for details on textile program and COM/COL information

Textiles are cut railroad by default

Dela

LOUNGE 4-LEG: ARMLESS

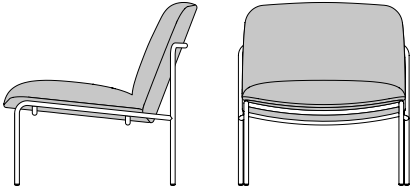
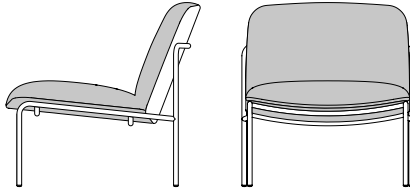
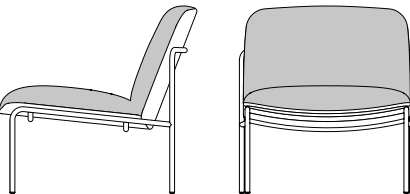
TITLE	SERIES	FRAME	ARM	STYLE	DIMENSIONS	COM	COL	Textile Upholstery Grades													Leather Upholstery Grades					
								YDG	SQFT	COM	A	B	C	D	E	F	G	H	I	J	K	L	M	W	X	Y
 Chair, Lounge 4-Leg Armless, Fully Upholstered	DL	5	1	1	27.25W x 27.5D x 29H	1.7	26.5	2,072	2,253	2,353	2,449	2,548	2,647	2,756	2,864	2,993	3,156	3,356	3,550	3,750	3,946	3,053	3,283	4,166	4,717	5,235
 Chair, Lounge 4-Leg Armless, Finished Wood Back	DL	5	1	2	27.25W x 27.5D x 29H	1.7	20.7	2,319	2,484	2,575	2,663	2,752	2,842	2,941	3,039	3,155	3,304	3,486	3,663	3,844	4,022	3,109	3,288	3,970	4,397	4,800
 Chair, Lounge 4-Leg Armless, Finished Wood Back and Seat	DL	5	1	3	27.25W x 27.5D x 29H	0.9	17.3	2,694	2,860	2,949	3,038	3,128	3,218	3,317	3,416	3,532	3,681	3,861	4,039	4,220	4,398	3,376	3,524	4,093	4,449	4,783

To Order Select Below

1. Series/Type/Frame/Style

DL511	DELA LOUNGE 4-LEG ARMLESS FULLY UPHOLSTERED
DL512	DELA LOUNGE 4-LEG ARMLESS FINISHED WOOD BACK
DL513	DELA LOUNGE 4-LEG ARMLESS FINISHED WOOD BACK AND SEAT

Contact Customer Service for custom contrasting upholstery details.

2. Options

Upholstery Options		
B1	BUTTON TUFT	+27
T1	LIBERTY TUFT	+71
WC	WELT CORD	+79
Welt cord is required with leather upholstery and already captured in list pricing above. Welt cord upcharge is only applicable for fabrics. Welt cord is available for all styles.		
DF	DUAL UPHOLSTERY	
	INSIDE	0.8 YDS
	OUTSIDE	0.7 YDS

When specifying in-graded fabrics, please apply the higher of the two grades. Dual Fabric only available on Fully Upholstered models. Welt Cord on Dual Fabric Models uses the Inside Textile.

3. Glides

Glide	
PG1	PLASTIC BLACK GLIDES
PG3	PLASTIC LIGHT GRAY GLIDES
FG1	PLASTIC BLACK GLIDES WITH FELT PADS
FG2	PLASTIC LIGHT GRAY GLIDES WITH FELT PADS

4. Wood Finish

Wood Finish	
PZ20	TONED WALNUT
PZ30	ALPI-RIFT CUT OAK

5. Frame Finish

Powder Coat					
BL	BLUE	LG	LIGHT GRAY	RO	RED ORANGE
BM	BLACK MATTE	MG	MEADOW GREEN	RR	RUSTY RED
BR	BRASS	MK	MILK	SB	SOFT BLUE
BT	BLACK TWILIGHT	MS	METALLIC SILVER	SD	SAND
CP	CHAMPAGNE	NK	NICKEL	TC	TERRACOTTA
DB	DARK BRONZE	NV	NAVY	TP	TAUPE
DG	DARK GRAY	OR	ORANGE	TS	TEXTURED SLATE
DP	DUSTY PINK	PY	PALE YELLOW	YL	YELLOW
FG	FOREST GREEN	RD	RED		
Chrome					
CH	CHROME				+276

6. Upholstery

See general information section for details on textile program and COM/COL information

Textiles are cut railroaded by default

Dela

LOUNGE 4-LEG: ARM

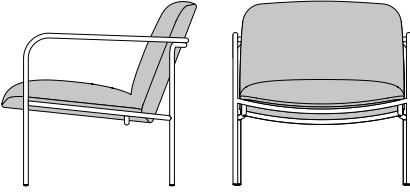
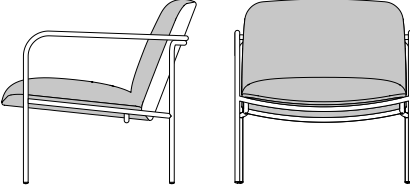
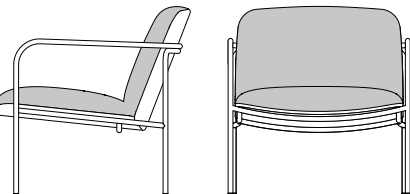
TITLE	SERIES	FRAME	ARM	STYLE	DIMENSIONS	COM	COL	Textile Upholstery Grades														Leather Upholstery Grades				
								YDG	SQFT	COM	A	B	C	D	E	F	G	H	I	J	K	L	M	W	X	Y
 Chair, Lounge 4-Leg Arm, Fully Upholstered	DL	5	2	1	27.25W x 27.5D x 29H	1.7	26.5	2,208	2,390	2,490	2,586	2,686	2,785	2,892	3,001	3,129	3,293	3,491	3,688	3,887	4,081	3,191	3,420	4,303	4,853	5,373
 Chair, Lounge 4-Leg Arm, Finished Wood Back	DL	5	2	2	27.25W x 27.5D x 29H	1.7	20.7	2,433	2,597	2,687	2,774	2,865	2,956	3,053	3,152	3,269	3,418	3,598	3,776	3,957	4,135	3,222	3,399	4,083	4,511	4,911
 Chair, Lounge 4-Leg Arm, Finished Wood Back and Seat	DL	5	2	3	27.25W x 27.5D x 29H	0.9	17.3	2,799	2,965	3,056	3,143	3,233	3,323	3,421	3,521	3,637	3,786	3,966	4,144	4,324	4,503	3,348	3,497	4,065	4,421	4,755

To Order Select Below

1. Series/Type/Frame/Style

DL521	DELA LOUNGE 4-LEG ARM FULLY UPHOLSTERED
DL522	DELA LOUNGE 4-LEG ARM FINISHED WOOD BACK
DL523	DELA LOUNGE 4-LEG ARM FINISHED WOOD BACK AND SEAT

Contact Customer Service for custom contrasting upholstery details.

2. Options

Upholstery Options		
B1	BUTTON TUFT	+27
T1	LIBERTY TUFT	+71
WC	WELT CORD	+79
Welt cord is required with leather upholstery and already captured in list pricing above. Welt cord upcharge is only applicable for fabrics. Welt cord is available for all styles.		
DF	DUAL UPHOLSTERY	
	INSIDE	0.8 YDS
	OUTSIDE	0.7 YDS

When specifying in-graded fabrics, please apply the higher of the two grades. Dual Fabric only available on Fully Upholstered models. Welt Cord on Dual Fabric Models uses the Inside Textile.

3. Glides

Glide		
PG1	PLASTIC BLACK GLIDES	
PG3	PLASTIC LIGHT GRAY GLIDES	
FG1	PLASTIC BLACK GLIDES WITH FELT PADS	
FG2	PLASTIC LIGHT GRAY GLIDES WITH FELT PADS	

4. Arm Cap Finish

Arm Cap		
UC	UPHOLSTERED	+416
81	OAK	+318
89	TONED WALNUT	+334
Upholstered arm cap textiles default to match the seat components. When Dual Fabric is selected, the inside textile is the default.		

5. Wood Finish

Wood Finish		
PZ20	TONED WALNUT	
PZ30	ALPI-RIFT CUT OAK	

6. Frame Finish

Powder Coat					
BL	BLUE	LG	LIGHT GRAY	RO	RED ORANGE
BM	BLACK MATTE	MG	MEADOW GREEN	RR	RUSTY RED
BR	BRASS	MK	MILK	SB	SOFT BLUE
BT	BLACK TWILIGHT	MS	METALLIC SILVER	SD	SAND
CP	CHAMPAGNE	NK	NICKEL	TC	TERRACOTTA
DB	DARK BRONZE	NV	NAVY	TP	TAUPE
DG	DARK GRAY	OR	ORANGE	TS	TEXTURED SLATE
DP	DUSTY PINK	PY	PALE YELLOW	YL	YELLOW
FG	FOREST GREEN	RD	RED		
Chrome					
CH	CHROME				+498

7. Upholstery

See general information section for details on textile program and COM/COL information

Textiles are cut railroaded by default

stylex

Ease Up

PRICE LIST

Effective November 01, 2023

General Information

GENERAL INFORMATION

Terms

Net 30 days from date of invoice.
FOB Delanco, NJ

Damaged Shipments

All Stylex products are carefully inspected before they are packed in sturdy cartons designed to satisfy shipping requirements. Stylex is not responsible for damage in shipment. The transportation company assumes responsibility for delivering products to you in good condition when the bill of lading is signed. You protect yourself by refusing shipments showing damage or shortage until transportation company has noted on the delivery sheet the extent of damage or shortage. Concealed damage should be reported to the carrier as soon as discovered, but not later than 15 days after receiving shipment.

Return/Restocking Policy

Return shipments will not be accepted unless specifically authorized by Stylex in writing. The Return Authorization number should be clearly marked on the carton. The customer returning Stylex products is responsible for return shipping costs. Merchandise must be returned unused. Returned merchandise is subject to a 35% restocking fee.

Specials/Customs

Modifications to standard products will be considered for large runs. Contact Stylex for more information.

Design Changes

In keeping with modern manufacturing advances, Stylex reserves the right to incorporate minor modifications and design changes in products without notice.

Cancellation Policy

No charge prior to production except for inventory specifically requisitioned to fulfill the particular order. After production has begun, only actual costs incurred, including labor and material, will be billed to the customer.

WARRANTY

Except as provided below, Stylex warrants exclusively to the original Purchaser of our product that all parts, under normal use and service, will be free from defects in workmanship and material for a period of ten (10) years from the date of purchase. "Normal use and service" means that the product will be used in a typical office environment for 40-45 hours per week.

This warranty is subject to the following limitations, exclusions and provisions:

Wood components of plywood stacking chairs
(such as Brooks and Welcome)
5 years

Upholstery
(including mesh used for Click, F4, Insight, and Zephyr Mesh)
3 years

SAVA Mesh
10 years

COM Upholstery
No warranty
Stylex makes every effort to ensure that the COM Upholstery it approves is suitable for the intended use. Nevertheless, we will not warrant, and assume no responsibility for, the durability or tailoring quality of any COM or COL. If you have any concerns about the ultimate appearance of any covering, please order an upholstered sample.

Painted Stack Chair Frames
No Warranty
We will not warrant the finish of painted stack chair frames against damage from stacking. We recommend ordering chrome frames for chairs that will be stacked.

Felt Glides
No warranty
Due to the different surfaces on which felt glides may be used, we cannot warrant their durability over time.

If this product fails during normal use and service within the applicable warranty period (other than through normal wear and tear), please send a description of the relevant part and the nature of the defect, together with proof of purchase of the product, to Stylex at: Customer Service. c/o Stylex, P.O. Box 5038, Delanco, NJ 08075. PLEASE DO NOT RETURN PARTS OR THE PRODUCT TO STYLEX UNLESS INSTRUCTED TO DO SO BY STYLEX. Stylex will, at its option, either repair or replace the product or the part found defective by Stylex completely without charge for materials or labor. Purchaser may be required (at the option of Stylex) to return to Stylex at Purchaser's expense any defective part with all freight or shipping charges prepaid. The foregoing warranty shall be void if the product has been altered or repaired (other than by Stylex). The warranty does not cover damage to the product caused by accident, neglect, misuse, abuse, modification to the product by anyone other than Stylex or damage caused by use of the product for a purpose other than that for which it was designed. This warranty extends only to the original Purchaser of the product.

No Other Warranties

This warranty is in lieu of all other warranties, expressed or implied, including, but not limited to, implied warranties of merchantability and fitness for a particular purpose. The rights and remedies provided herein are the exclusive rights and remedies of the original purchaser of the product.

No Liability For Damages

In no event shall Stylex or its suppliers be responsible or liable for any special, indirect, consequential, or incidental damages. In no event shall the liability of Stylex exceed the actual purchase price paid to Stylex for the product.

Out of Warranty Products

For all products no longer covered by our warranty, please refer to our Design for Durability and Upgradability Policy. Contact Customer Service if you would like to purchase any replaceable components to further extend the life of any Stylex seating product. This warranty applies to all Stylex products purchased on April 13, 2018, and thereafter.

PRODUCT TAKE BACK PROGRAM

At Stylex, responsible stewardship of our products extends beyond their initial use. Our Product Take Back Program provides a practical solution for the end of our products' intended life cycle.

Through our partnership with ANEW, a 501(c)(3) nonprofit organization, we offer clients a comprehensive take-back solution for surplus office furniture and materials, regardless of their condition. ANEW's mission aligns with ours—to connect surplus resources with non-profits, public agencies, and underserved communities, minimizing landfill impact and maximizing corporate social responsibility.

By repurposing surplus items, we strengthen community networks and reduce environmental impact. Stylex proudly supports ANEW, integrating this partnership into our strategic sales strategy since 2014. Learn more at www.anewfound.org.

Initiate a Product Take Back through ANEW by emailing Stylex at info@stylexdesign.com. For additional end-of-life recovery options, refer to our Product Disassembly Instructions and End of Life Recovery Options documents, available in the Resources section of each product on our website. Together, let's build a sustainable future.

FREIGHT PROGRAM

Stylex offers a Guaranteed Freight Program, which provides the purchaser the ability to determine shipping and handling charges at the time of order. Freight charges will be calculated as a percentage of the net product price and added to the invoice at the time of shipment. The continental United States has been divided into three zones. Please use the map below to determine the freight charges for the product's destination. There is a minimum freight charge of \$150.

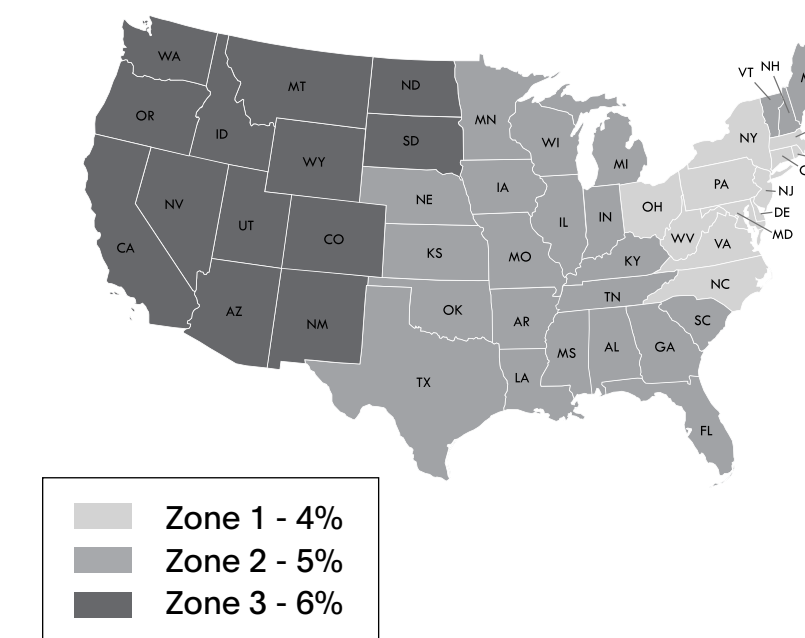

ZONE 1 - 4%

Connecticut
Delaware
New York
New Jersey
Maryland
Massachusetts
North Carolina
Ohio
Pennsylvania
Rhode Island
Virginia
Washington D.C.
West Virginia

ZONE 2 - 5%

Alabama
Arkansas
Canada, Ontario
Canada, Quebec
Florida
Georgia
Iowa
Illinois
Indiana
Kansas
Kentucky
Louisiana
Nebraska
New Hampshire
Oklahoma
Maine
Michigan
Minnesota
Missouri
Mississippi
South Carolina
Tennessee
Texas
Vermont
Wisconsin

ZONE 3 - 6%

Arizona
California
Colorado
Idaho
Montana
Nevada
New Mexico
North Dakota
Oregon
South Dakota
Utah
Washington
Wyoming

Quote Per Project

Alaska
Hawaii
Canada
(outside Ontario & Quebec)
Mexico

General Information

TEXTILE PARTNERS & APPROVALS

Textile Partners

To customize your furniture performance needs and design vision, Stylex offers a wide selection of in-graded leathers and textiles from Grades A through Y. We've partnered with leading manufacturers on the options, focusing on color, price, durability, and construction. To view our partners and explore our digital carded program with broadly approved textiles, visit [this page](#). We stand by these textiles: They're tried and tested, and will effortlessly fit into any design aesthetic.

Textile Approvals

To view Stylex Approved Textile documents to determine specific product approval status, refer to our Product Tested Textiles documents, available in the Resources section of each product on our website.

CAL 117 AND 133 COMPLIANCE

CAL 117-2013

All Stylex seating satisfies the requirements of CAL 117-2013 so long as one of our standard or in-graded textiles is applied. COM textiles cannot be so guaranteed. Please contact the supplier of COM's directly to determine the fire retardancy of any COM supplied to us.

CAL 133

Most Stylex seating can be ordered to meet the requirements of CAL 133. When ordering, simply specify "CAL 133 compliance required". The upcharge for this option is \$54 list per yard. Please refer to the COM yardage of each model to determine the number of yards required. We do frequently require full-scale burn tests in order to certify CAL 133 before an order will be accepted. Such burn tests may increase normal lead times and do carry additional charges. Please contact customer service for details.

CUSTOMER'S OWN MATERIAL/LEATHER

Customer's own material (COM) and customer's own leather (COL) will generally be upholstered at the price designated in each product's price list. Please be advised, however, that we specifically reserve the right to charge a higher price when we determine that special circumstances, such as unusual repeats or challenging materials, present themselves. All orders for custom coverings must be approved by Stylex before they will be accepted for production. To submit proposed textile for approval, please use the COM form [here](#).

Special Note:

We assume no responsibility for the durability or tailoring quality of any COM or COL. Directional covers in particular may not meet your satisfaction due to the design of certain products. Please be advised that COM and COL orders are not subject to return. If you have doubts about the ultimate appearance of certain coverings, please order a sample done with that specific COM or COL. In addition, while we inspect textiles for mill imperfections, some are difficult to recognize. We cannot be responsible for defects, color inaccuracies, dye lot variations, or other flaws.

Under no circumstances will we be responsible for COM shortages, flaws, or other such problems. Finally, it is not our responsibility to police the receipt of COM's in order to meet delivery deadlines, and we assume our customers are aware of any undue delay in the shipment of their COM textiles.

COM textile and COL leather should be sent prepaid to: Stylex

**Attn: COM/COL - [Your PO #]
740 Coopertown Road
Delanco, NJ 08075**

Clearly mark textile or leather with the dealer's name, purchase order number, and furniture model number of the item to be covered. Actual furniture orders should include the same information, as well as a description of the textile or leather, including pattern and color number, in order to provide a cross reference.

Yardage requirements shown in the price list are based on non-directional goods of 54" width. Textiles less than 54" wide or those requiring matching (stripes, prints, or large patterned designs) call for additional yardage. We will be happy to supply yardage requirements for large quantities where economies may be realized.

Add the following yardage for stripes, plaids, or patterns with repeats:

Textile Width	Plain Textile	2-14" Repeat	15-24" Repeat	25-27" Repeat	28-36" Repeat
54"	0%	10%	15%	20%	25%
50"	10%	20%	25%	30%	35%
48"	15%	25%	30%	35%	40%
45"	40%	50%	55%	60%	65%
36"	50%	60%	65%	70%	75%

COM/COL FORM

To avoid delay in processing COM orders we request that you submit a sample of your COM textile stapled to this form which can be downloaded [here](#). If a textile has a stripe or design, the size of the repeat should be indicated. Please indicate the textile supplier's name, textile number, and color. Also indicate the Stylex product on which the textile will be used.

The textile supplier must indicate on his shipping labels the dealer name and purchase order number as well as the Stylex model number.

Please Note:

No order may be entered into production or have a shipping date assigned until all related COM is received at the factory.



CENTER OF STRIPE OR DESIGN

TOP	TOP
-----	-----

1. Size of Repeat

2. Textile Supplier

3. Textile Number

4. Color

5. Stylex Product

Ease Up

SPECIFICATION GUIDE: OVERVIEW AND DIMENSIONS

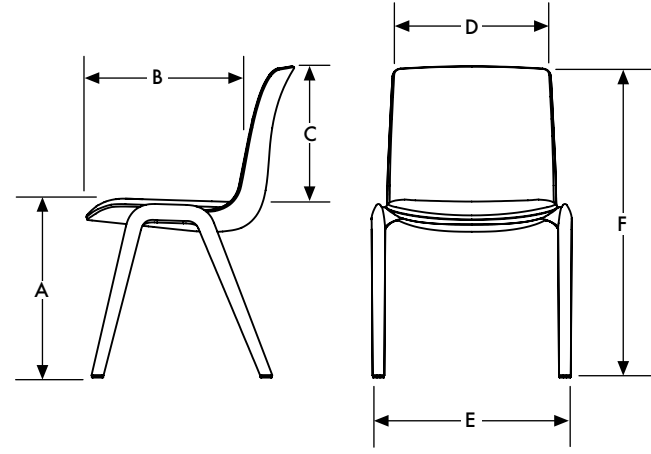
OVERVIEW	MULTI-USE CHAIR
<p>Dimensions</p> <ul style="list-style-type: none"> A. Seat Height B. Seat Depth C. Back Height D. Back Width E. Armless Overall Width F. Maximum Overall Height 	<ul style="list-style-type: none"> A. 18.5" B. 17.5" C. 13.71" D. 17.25" E. 17.66" F. 31.21"

PRODUCT INFORMATION
<p>Design Martin Ballendat</p> <p>Construction Chairs are injection-molded, recyclable polypropylene. Upholstered seat pads are 1" of CFC-free, high-density polyurethane foam over injection-molded polypropylene substrates.</p> <p>Stacking Chairs stack up to 12 chairs high on the floor, hand truck, or dolly.</p> <p>Storage Storage options include a dolly and a hand truck.</p> <p>Use Designed for indoor use only.</p> <p>Performance Standards Manufactured to comply with: ANSI/BIFMA X5.1 General-Purpose Office Chairs - Tests</p> <p>Certifications GREENGUARD Gold LEVEL® 1 (Anticipated Q4 2023)</p>

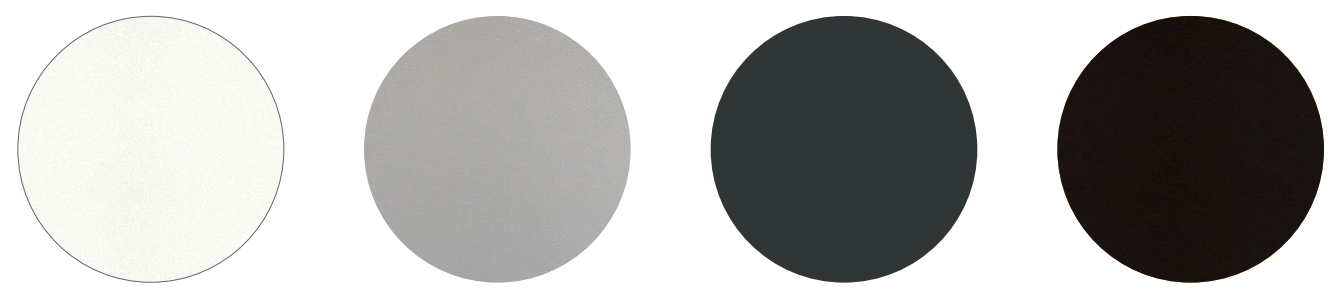
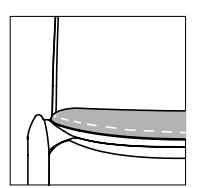
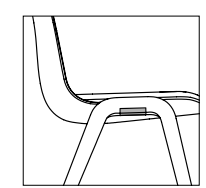
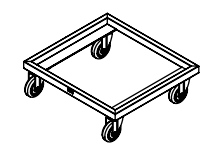
POLYPROPYLENE COLORS	OPTIONS	
 <ul style="list-style-type: none"> <li data-bbox="76 1369 266 1435">MILK (02) <li data-bbox="299 1369 483 1435">LIGHT GRAY (03) <li data-bbox="516 1369 699 1435">DARK GRAY (04) <li data-bbox="733 1369 949 1453">MATTE BLACK (01) 	<p>Options</p> <p>Contrasting Thread</p> 	<p>Ganging Bracket</p>  <hr/> <p>Accessories</p> <p>Hand Truck</p>  <p>Dolly</p> 

Ease Up

MULTI-USE POLY CHAIR

TITLE	SERIES	DIMENSIONS	YDG	Textile Upholstery Grades													
				COM	A	B	C	D	E	F	G	H	I	J	K	L	M
Ease Up, Multi-Use Poly Chair	EU	17.7W x 17.5D x 31.2H	0.6	353	389	410	430	450	471	493	515	542	573	610	649	687	724

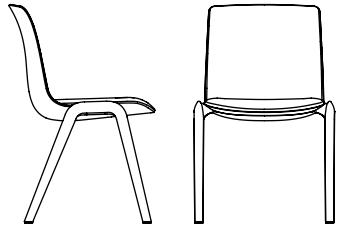

To Order Select Below

1. Series

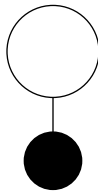

EU

**Ease Up
Multi-Use Poly Chair**

2. Frame Color

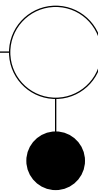

Polypropylene

- 01 BLACK MATTE
- 02 MILK
- 03 LIGHT GRAY
- 04 DARK GRAY

3. Options

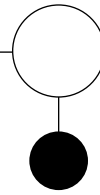

Options

- CT CONTRASTING THREAD
- G GANGING BRACKET **+48**

Accessories

- EUHT HAND TRUCK **+1,163**
- EUFD DOLLY **+575**

4. Upholstery

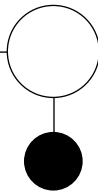

See general information section for details on textile program and COM/COL information.

stylex

F4

PRICE LIST

Effective November 01, 2023

General Information

GENERAL INFORMATION

Terms

Net 30 days from date of invoice.
FOB Delanco, NJ

Damaged Shipments

All Stylex products are carefully inspected before they are packed in sturdy cartons designed to satisfy shipping requirements. Stylex is not responsible for damage in shipment. The transportation company assumes responsibility for delivering products to you in good condition when the bill of lading is signed. You protect yourself by refusing shipments showing damage or shortage until transportation company has noted on the delivery sheet the extent of damage or shortage. Concealed damage should be reported to the carrier as soon as discovered, but not later than 15 days after receiving shipment.

Return/Restocking Policy

Return shipments will not be accepted unless specifically authorized by Stylex in writing. The Return Authorization number should be clearly marked on the carton. The customer returning Stylex products is responsible for return shipping costs. Merchandise must be returned unused. Returned merchandise is subject to a 35% restocking fee.

Specials/Customs

Modifications to standard products will be considered for large runs. Contact Stylex for more information.

Design Changes

In keeping with modern manufacturing advances, Stylex reserves the right to incorporate minor modifications and design changes in products without notice.

Cancellation Policy

No charge prior to production except for inventory specifically requisitioned to fulfill the particular order. After production has begun, only actual costs incurred, including labor and material, will be billed to the customer.

WARRANTY

Except as provided below, Stylex warrants exclusively to the original Purchaser of our product that all parts, under normal use and service, will be free from defects in workmanship and material for a period of ten (10) years from the date of purchase. "Normal use and service" means that the product will be used in a typical office environment for 40-45 hours per week.

This warranty is subject to the following limitations, exclusions and provisions:

Wood components of plywood stacking chairs
(such as Brooks and Welcome)
5 years

Upholstery
(including mesh used for Click, F4, Insight, and Zephyr Mesh)
3 years

SAVA Mesh
10 years

COM Upholstery
No warranty
Stylex makes every effort to ensure that the COM Upholstery it approves is suitable for the intended use. Nevertheless, we will not warrant, and assume no responsibility for, the durability or tailoring quality of any COM or COL. If you have any concerns about the ultimate appearance of any covering, please order an upholstered sample.

Painted Stack Chair Frames
No Warranty
We will not warrant the finish of painted stack chair frames against damage from stacking. We recommend ordering chrome frames for chairs that will be stacked.

Felt Glides
No warranty
Due to the different surfaces on which felt glides may be used, we cannot warrant their durability over time.

If this product fails during normal use and service within the applicable warranty period (other than through normal wear and tear), please send a description of the relevant part and the nature of the defect, together with proof of purchase of the product, to Stylex at: Customer Service. c/o Stylex, P.O. Box 5038, Delanco, NJ 08075. PLEASE DO NOT RETURN PARTS OR THE PRODUCT TO STYLEX UNLESS INSTRUCTED TO DO SO BY STYLEX. Stylex will, at its option, either repair or replace the product or the part found defective by Stylex completely without charge for materials or labor. Purchaser may be required (at the option of Stylex) to return to Stylex at Purchaser's expense any defective part with all freight or shipping charges prepaid. The foregoing warranty shall be void if the product has been altered or repaired (other than by Stylex). The warranty does not cover damage to the product caused by accident, neglect, misuse, abuse, modification to the product by anyone other than Stylex or damage caused by use of the product for a purpose other than that for which it was designed. This warranty extends only to the original Purchaser of the product.

No Other Warranties

This warranty is in lieu of all other warranties, expressed or implied, including, but not limited to, implied warranties of merchantability and fitness for a particular purpose. The rights and remedies provided herein are the exclusive rights and remedies of the original purchaser of the product.

No Liability For Damages

In no event shall Stylex or its suppliers be responsible or liable for any special, indirect, consequential, or incidental damages. In no event shall the liability of Stylex exceed the actual purchase price paid to Stylex for the product.

Out of Warranty Products

For all products no longer covered by our warranty, please refer to our Design for Durability and Upgradability Policy. Contact Customer Service if you would like to purchase any replaceable components to further extend the life of any Stylex seating product. This warranty applies to all Stylex products purchased on April 13, 2018, and thereafter.

PRODUCT TAKE BACK PROGRAM

At Stylex, responsible stewardship of our products extends beyond their initial use. Our Product Take Back Program provides a practical solution for the end of our products' intended life cycle.

Through our partnership with ANEW, a 501(c)(3) nonprofit organization, we offer clients a comprehensive take-back solution for surplus office furniture and materials, regardless of their condition. ANEW's mission aligns with ours—to connect surplus resources with non-profits, public agencies, and underserved communities, minimizing landfill impact and maximizing corporate social responsibility.

By repurposing surplus items, we strengthen community networks and reduce environmental impact. Stylex proudly supports ANEW, integrating this partnership into our strategic sales strategy since 2014. Learn more at www.anewfound.org.

Initiate a Product Take Back through ANEW by emailing Stylex at info@stylexdesign.com. For additional end-of-life recovery options, refer to our Product Disassembly Instructions and End of Life Recovery Options documents, available in the Resources section of each product on our website. Together, let's build a sustainable future.

FREIGHT PROGRAM

Stylex offers a Guaranteed Freight Program, which provides the purchaser the ability to determine shipping and handling charges at the time of order. Freight charges will be calculated as a percentage of the net product price and added to the invoice at the time of shipment. The continental United States has been divided into three zones. Please use the map below to determine the freight charges for the product's destination. There is a minimum freight charge of \$150.

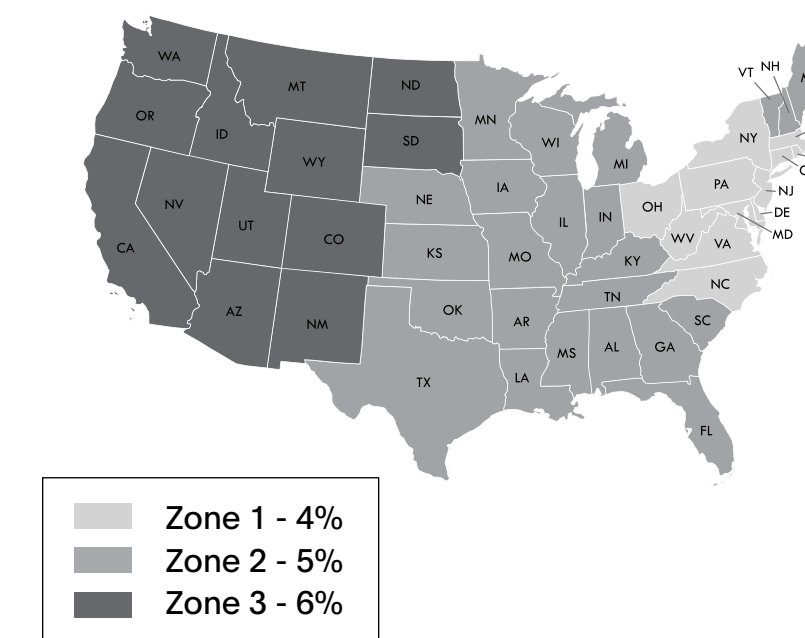

ZONE 1 - 4%

Connecticut
Delaware
New York
New Jersey
Maryland
Massachusetts
North Carolina
Ohio
Pennsylvania
Rhode Island
Virginia
Washington D.C.
West Virginia

ZONE 2 - 5%

Alabama
Arkansas
Canada, Ontario
Canada, Quebec
Florida
Georgia
Iowa
Illinois
Indiana
Kansas
Kentucky
Louisiana
Nebraska
New Hampshire
Oklahoma
Maine
Michigan
Minnesota
Mississippi
South Carolina
Tennessee
Texas
Vermont
Wisconsin

ZONE 3 - 6%

Arizona
California
Colorado
Idaho
Montana
Nevada
New Mexico
North Dakota
Oregon
South Dakota
Utah
Washington
Wyoming

Quote Per Project

Alaska
Hawaii
Canada
(outside Ontario & Quebec)
Mexico

General Information

TEXTILE PARTNERS & APPROVALS

Textile Partners

To customize your furniture performance needs and design vision, Stylex offers a wide selection of in-graded leathers and textiles from Grades A through Y. We've partnered with leading manufacturers on the options, focusing on color, price, durability, and construction. To view our partners and explore our digital carded program with broadly approved textiles, visit [this page](#). We stand by these textiles: They're tried and tested, and will effortlessly fit into any design aesthetic.

Textile Approvals

To view Stylex Approved Textile documents to determine specific product approval status, refer to our Product Tested Textiles documents, available in the Resources section of each product on our website.

CAL 117 AND 133 COMPLIANCE

CAL 117-2013

All Stylex seating satisfies the requirements of CAL 117-2013 so long as one of our standard or in-graded textiles is applied. COM textiles cannot be so guaranteed. Please contact the supplier of COM's directly to determine the fire retardancy of any COM supplied to us.

CAL 133

Most Stylex seating can be ordered to meet the requirements of CAL 133. When ordering, simply specify "CAL 133 compliance required". The upcharge for this option is \$54 list per yard. Please refer to the COM yardage of each model to determine the number of yards required. We do frequently require full-scale burn tests in order to certify CAL 133 before an order will be accepted. Such burn tests may increase normal lead times and do carry additional charges. Please contact customer service for details.

CUSTOMER'S OWN MATERIAL/LEATHER

Customer's own material (COM) and customer's own leather (COL) will generally be upholstered at the price designated in each product's price list. Please be advised, however, that we specifically reserve the right to charge a higher price when we determine that special circumstances, such as unusual repeats or challenging materials, present themselves. All orders for custom coverings must be approved by Stylex before they will be accepted for production. To submit proposed textile for approval, please use the COM form [here](#).

Special Note:

We assume no responsibility for the durability or tailoring quality of any COM or COL. Directional covers in particular may not meet your satisfaction due to the design of certain products. Please be advised that COM and COL orders are not subject to return. If you have doubts about the ultimate appearance of certain coverings, please order a sample done with that specific COM or COL. In addition, while we inspect textiles for mill imperfections, some are difficult to recognize. We cannot be responsible for defects, color inaccuracies, dye lot variations, or other flaws.

Under no circumstances will we be responsible for COM shortages, flaws, or other such problems. Finally, it is not our responsibility to police the receipt of COM's in order to meet delivery deadlines, and we assume our customers are aware of any undue delay in the shipment of their COM textiles.

COM textile and COL leather should be sent prepaid to: Stylex

**Attn: COM/COL - [Your PO #]
740 Coopertown Road
Delanco, NJ 08075**

Clearly mark textile or leather with the dealer's name, purchase order number, and furniture model number of the item to be covered. Actual furniture orders should include the same information, as well as a description of the textile or leather, including pattern and color number, in order to provide a cross reference.

Yardage requirements shown in the price list are based on non-directional goods of 54" width. Textiles less than 54" wide or those requiring matching (stripes, prints, or large patterned designs) call for additional yardage. We will be happy to supply yardage requirements for large quantities where economies may be realized.

Add the following yardage for stripes, plaids, or patterns with repeats:

Textile Width	Plain Textile	2-14" Repeat	15-24" Repeat	25-27" Repeat	28-36" Repeat
54"	0%	10%	15%	20%	25%
50"	10%	20%	25%	30%	35%
48"	15%	25%	30%	35%	40%
45"	40%	50%	55%	60%	65%
36"	50%	60%	65%	70%	75%

COM/COL FORM

To avoid delay in processing COM orders we request that you submit a sample of your COM textile stapled to this form which can be downloaded [here](#). If a textile has a stripe or design, the size of the repeat should be indicated. Please indicate the textile supplier's name, textile number, and color. Also indicate the Stylex product on which the textile will be used.

The textile supplier must indicate on his shipping labels the dealer name and purchase order number as well as the Stylex model number.

Please Note:

No order may be entered into production or have a shipping date assigned until all related COM is received at the factory.



CENTER OF STRIPE OR DESIGN

TOP	TOP
-----	-----

1. Size of Repeat

2. Textile Supplier

3. Textile Number

4. Color

5. Stylex Product

Contents

<hr/>		<hr/>	
COLORS, MATERIALS, AND FINISHES	5	STANDARD HEIGHT	9
<hr/>		<hr/>	
STATEMENT OF LINE	6	COUNTER STOOL	12
<hr/>		<hr/>	
DIMENSIONS	7	BAR STOOL	15
<hr/>		<hr/>	
HOW TO ORDER	8		
<hr/>			

CLICK THE TITLES ABOVE TO NAVIGATE THROUGH THE DOCUMENT
PRODUCT HEADERS ON SUBSEQUENT PAGES LINK BACK TO THIS PAGE

F4

COLORS, MATERIALS, AND FINISHES

POWDER COATED PAINTED METAL & POLISHED METAL

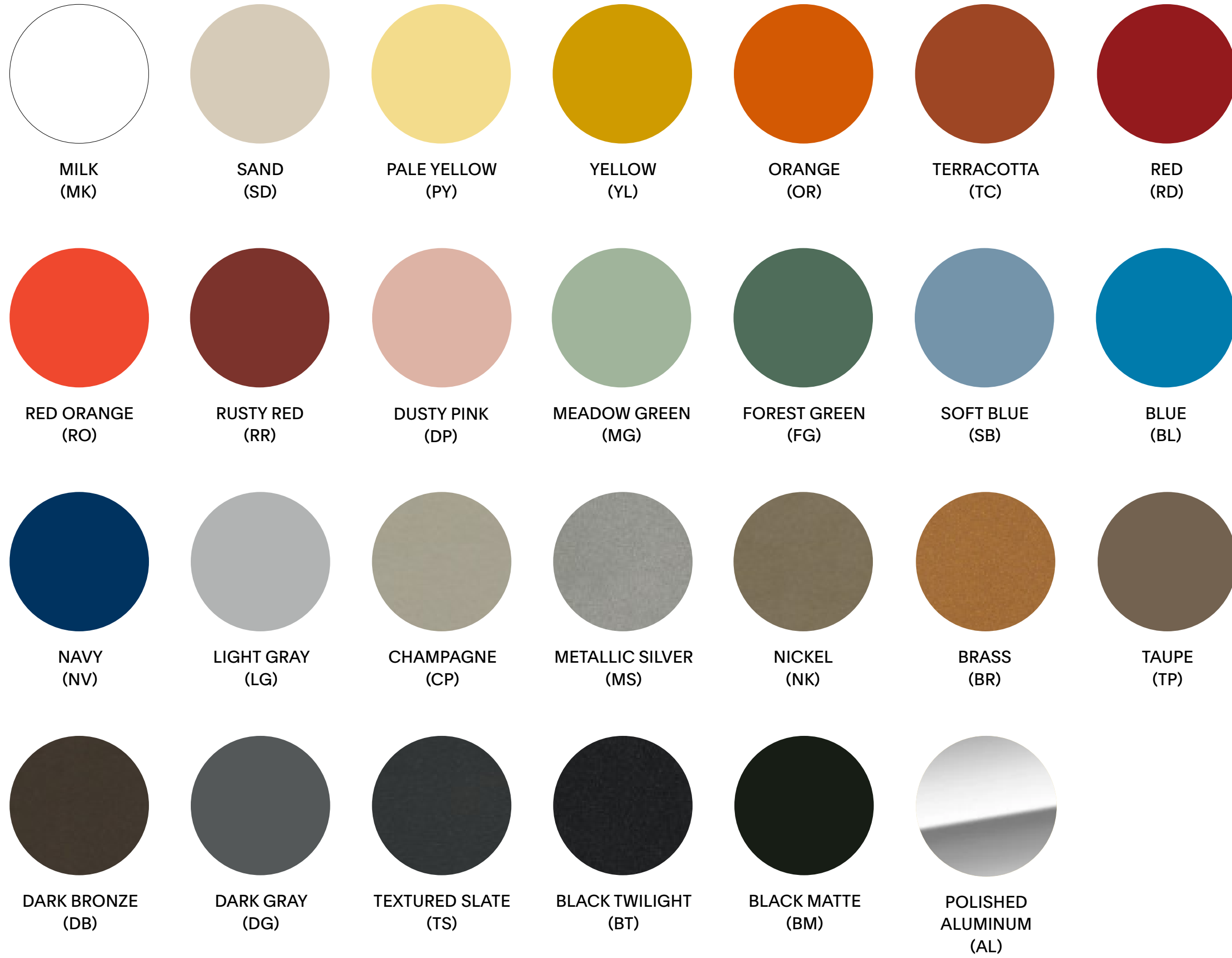

MESH BACK & KNIT SEAT



BACK FRAME







WOOD ARMS

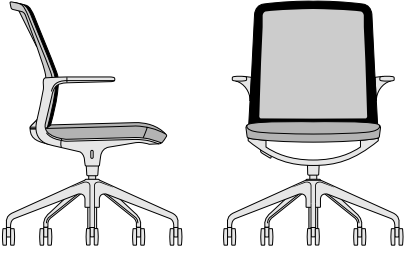
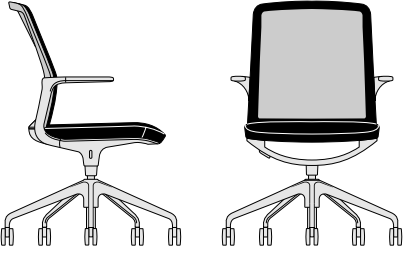
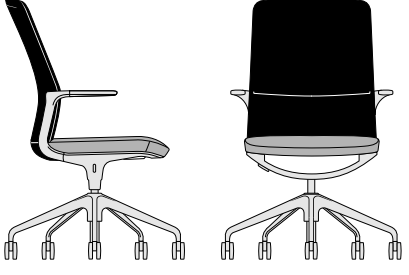
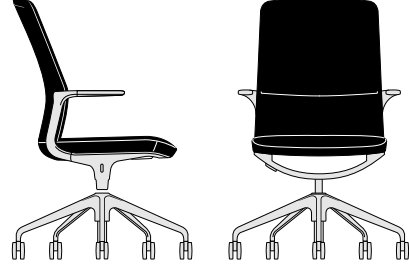
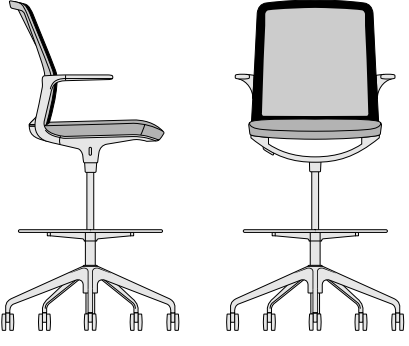
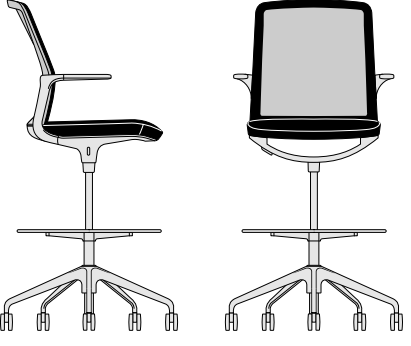
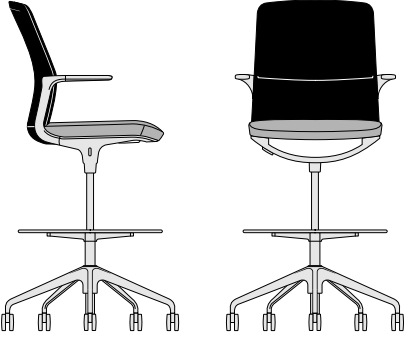

F4

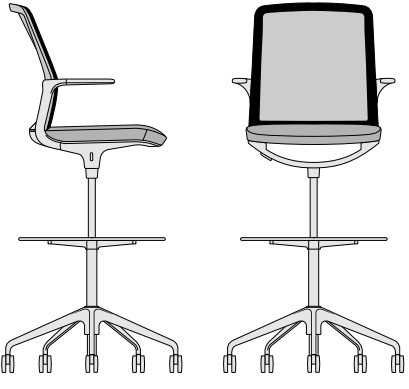
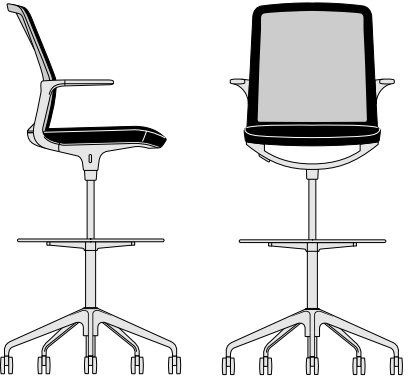
SPECIFICATION GUIDE: STATEMENT OF LINE

OVERVIEW	MESH BACK/KNIT SEAT	MESH BACK/UPHOLSTERED SEAT	UPHOLSTERED BACK/KNIT SEAT	FULLY UPHOLSTERED
Standard Height Arm or Armless	Medium Back 	Medium Back 	Medium or High Back 	Medium or High Back 
Counter Stool Arm or Armless	Medium Back 	Medium Back 	Medium or High Back 	Medium or High Back 
Bar Stool Arm or Armless	Medium Back 	Medium Back 	Medium or High Back 	Medium or High Back 

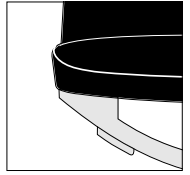
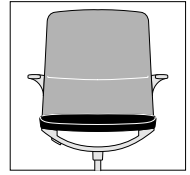
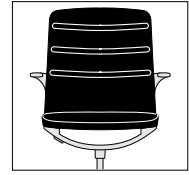
OPTIONS			
Contrasting Thread 	Dual Upholstered Seat and Back 	Decorative Upholstery 	Arm Caps 

PRODUCT INFORMATION

Design
Fig 40

Back Construction
Upholstered backs utilize an internal frame of welded steel rod integrated with a flexible B-surface material and covered with polyurethane foam.

Mesh backs have injection-molded, glass-filled frames to which the mesh is applied.

Seat Construction
Both upholstered and knit seats incorporate a flexible polypropylene seat pan on which is placed a dual-density cushion of molded, CFC-free foam.

The mechanism, comprised primarily of steel and aluminum, has fixed tension with movement controlled by two series of leaf springs, one on either side of the seat. A height adjustment button is located on the right side of the cast aluminum yoke supporting the seat pan.

Bases
Bases are produced from cast aluminum and have five blades. Casters are available in black, gray, and chrome trim, all in carpet or soft wheel versions.

Use
Designed for indoor use only.

Performance Standards
Manufactured to comply with:
ANSI/BIFMA X5.1 General-Purpose Office Chairs - Tests

Certifications
GREENGUARD Gold
LEVEL® 1

F4

SPECIFICATION GUIDE: DIMENSIONS

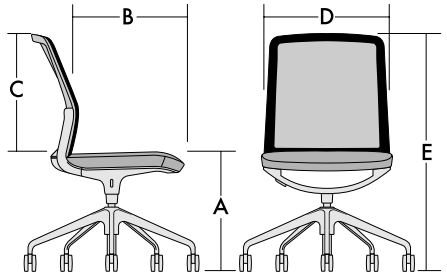
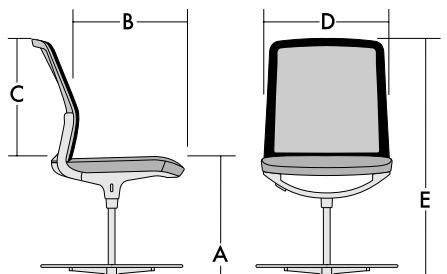
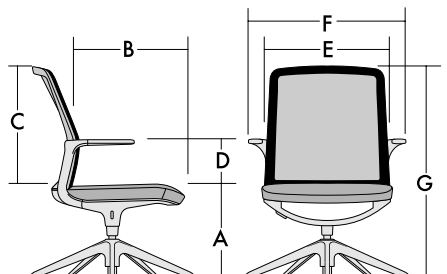
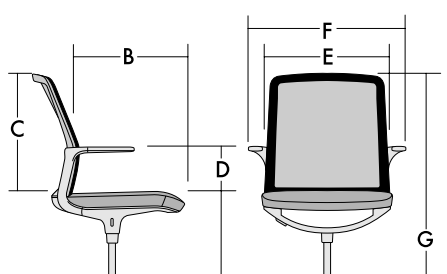
DIMENSIONS	STANDARD HEIGHT		COUNTER STOOL		BAR STOOL	
<p>Armless Models</p> <p>A. Seat Height B. Seat Depth C. Back Height D. Seat Width E. Maximum Overall Height</p>  	<p>Medium Back</p> <p>A. 17.75 - 22.75 B. 17 C. 18 D. 19.5 E. 36 - 41</p>	<p>High Back</p> <p>A. 17.75 - 22.75 B. 17 C. 20.5 D. 19.5 E. 38.5 - 43.5</p>	<p>Medium Back</p> <p>A. 24 - 31.5 B. 17 C. 18 D. 19.5 E. 42.25 - 49.75</p>	<p>High Back</p> <p>A. 24 - 31.5 B. 17 C. 20.5 D. 19.5 E. 44.75 - 52.25</p>	<p>Medium Back</p> <p>A. 26.5 - 36.5 B. 17 C. 18 D. 19.5 E. 44.75 - 54.75</p>	<p>High Back</p> <p>A. 26.5 - 36.5 B. 17 C. 20.5 D. 19.5 E. 49.25 - 57.25</p>
<p>Arm Models</p> <p>A. Seat Height B. Seat Depth C. Back Height D. Arm Height E. Back Width F. Overall Arm Width G. Maximum Overall Height</p>  	<p>Medium Back</p> <p>A. 17.75 - 22.75 B. 17 C. 18 D. 6.75 E. 17.25 F. 24 G. 36 - 41</p>	<p>High Back</p> <p>A. 17.75 - 22.75 B. 17 C. 20.5 D. 6.75 E. 17.25 F. 24 G. 38.5 - 43.5</p>	<p>Medium Back</p> <p>A. 24 - 31.5 B. 17 C. 18 D. 6.75 E. 17.25 F. 24 G. 42.25 - 49.75</p>	<p>High Back</p> <p>A. 24 - 31.5 B. 17 C. 20.5 D. 6.75 E. 17.25 F. 24 G. 44.75 - 52.25</p>	<p>Medium Back</p> <p>A. 26.5 - 36.5 B. 17 C. 18 D. 6.75 E. 17.25 F. 24 G. 44.75 - 54.75</p>	<p>High Back</p> <p>A. 26.5 - 36.5 B. 17 C. 20.5 D. 6.75 E. 17.25 F. 24 G. 49.25 - 57.25</p>

F4

SPECIFICATION GUIDE: HOW TO ORDER

MODEL CODE BREAKDOWN

Sample Model Code: F262MBCA1ALB1T11CTM01COM

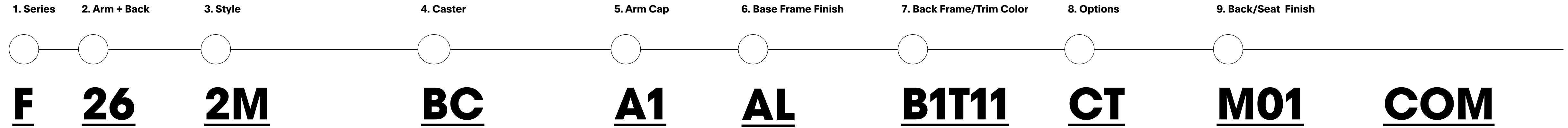

1. Series	2. Arm + Back	3. Style	4. Caster	5. Arm Cap	6. Base Frame Finish	7. Back Frame/Trim Color	8. Options	9. Back/Seat Finish	
F	26	2M	BC	A1	AL	B1T11	CT	M01	COM
Series F F4	Arm 1 ARMLESS 2 ARM Back 6 MEDIUM BACK 8 HIGH BACK	Style Standard Height 1 MESH BACK, KNIT SEAT 2 MESH BACK, UPHOLSTERED SEAT 3 UPHOLSTERED BACK, KNIT SEAT 4 FULLY UPHOLSTERED 4DF DUAL UPHOLSTERY Counter Stool 1M MESH BACK, KNIT SEAT 2M MESH BACK, UPHOLSTERED SEAT 3M UPHOLSTERED BACK, KNIT SEAT 4M FULLY UPHOLSTERED 4MDF DUAL UPHOLSTERY Bar Stool 1H MESH BACK, KNIT SEAT 2H MESH BACK, UPHOLSTERED SEAT 3H UPHOLSTERED BACK, KNIT SEAT 4H FULLY UPHOLSTERED 4HDF DUAL UPHOLSTERY	Casters Black Casters BC BLACK CARPET CASTERS BS BLACK SOFT CASTERS Chrome Casters CC CHROME TRIM CASTERS CS CHROME TRIM SOFT CASTERS Gray Casters GC GRAY CARPET CASTERS GS GRAY SOFT CASTERS	Arm Cap Polyurethane A1 BLACK A2 GRAY Wood 81 WHITE OAK 85 WALNUT Aluminum 70 ALUMINUM	Base Frame Color Standard Powder Coat BL BLUE BM BLACK MATTE BR BRASS BT BLACK TWILIGHT CP CHAMPAGNE DB DARK BRONZE DG DARK GRAY DP DUSTY PINK FG FOREST GREEN LG LIGHT GRAY MG MEADOW GREEN MK MILK MS METALLIC SILVER NK NICKLE NV NAVY OR ORANGE PY PALE YELLOW RD RED RO RED ORANGE RR RUSTY RED SB SOFT BLUE SD SAND TC TERRACOTTA TP TAUPE TS TEXTURED SLATE YL YELLOW Chrome AL POLISHED ALUMINUM	Back Frame B1 BLACK B2 GRAY B3 WHITE Trim Color T01 CHROME CYLINDER BLACK CAP, BUTTON T11 ALL BLACK T22 ALL GRAY T31 WHITE CYLINDER, BLACK CAP, BUTTON T32 WHITE CYLINDER, GRAY CAP, BUTTON	Options HL HEIGHT LOCK CT CONTRASTING THREAD Decorative Upholstery D1 CHANNEL D2 LOOP	Mesh Back Color M01 BLACK M02 GRAPHITE M03 SMOKE M05 WHITE M13 POPPY M15 MIDNIGHT BLUE M22 BLACK/SMOKE M23 BLACK/BRONZE M26 BLACK/MIDNIGHT BLUE M27 BLACK/RED M28 WHITE/SMOKE Knit Seat Color K01 BLACK K02 GRAPHITE K03 SMOKE K13 POPPY K15 MIDNIGHT BLUE K22 BLACK/SMOKE K23 BLACK/BRONZE K26 MIDNIGHT BLUE/BLACK K27 RED/BLACK K28 WHITE/SMOKE	Textile Grades COM CUSTOMER'S OWN MATERIAL A GRADE A B GRADE B C GRADE C D GRADE D E GRADE E F GRADE F G GRADE G H GRADE H I GRADE I J GRADE J K GRADE K L GRADE L M GRADE M Leather Grades COL CUSTOMER'S OWN LEATHER W GRADE W X GRADE X Y GRADE Y E1 GRADE E1 E2 GRADE E2

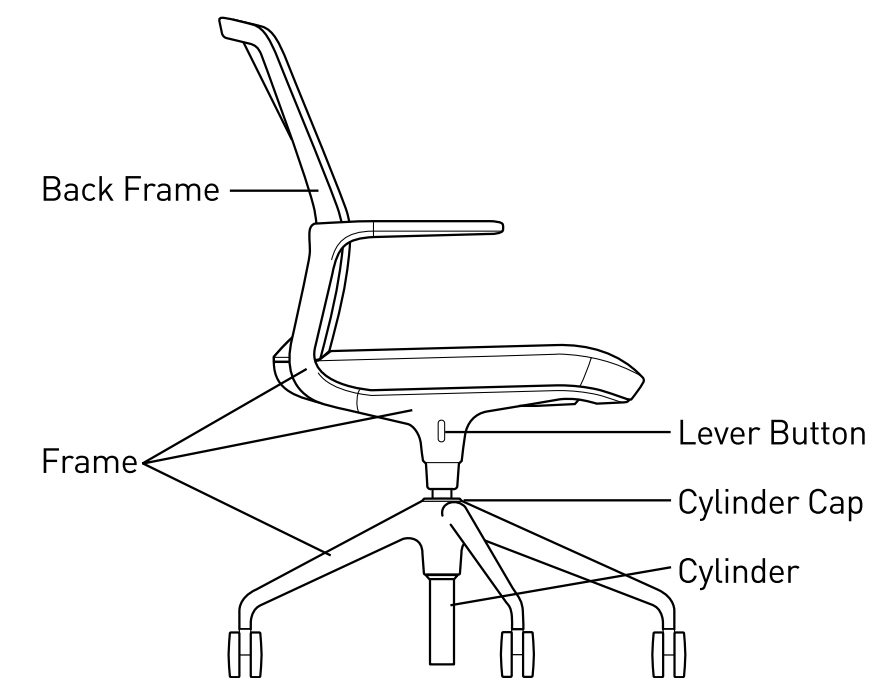

Note: Select highest grade in the case of dual upholstery

F4

STANDARD HEIGHT: MESH BACK

TITLE	SERIES	ARM	BACK	UPH	HEIGHT	DIMENSIONS	YDG	SQFT	Textile Upholstery Grades												Leather Upholstery Grades						
									COM	COL	COM	A	B	COL	C	D	E	F	G	H	I	J	K	L	M	W	X
Standard Height, Mesh Back and Knit Seat, Medium Back, Arm	F	2	6	1		24W x 26D x 36 - 41H	0	0	1,256																		
Standard Height, Mesh Back and Knit Seat, Medium Back, Armless	F	1	6	1		19.5W x 26D x 36 - 41H	0	0	1,230																		
Standard Height, Mesh Back and Upholstered Seat, Medium Back, Arm	F	2	6	2		24W x 26D x 36 - 41H	0.8	9	1,220	1,275	1,306	1,336	1,364	1,397	1,430	1,463	1,502	1,553	1,614	1,674	1,736	1,796	1,492	1,551	1,737	1,814	2,025
Standard Height, Mesh Back and Upholstered Seat, Medium Back, Armless	F	1	6	2		19.5W x 26D x 36 - 41H	0.8	9	1,194	1,248	1,280	1,309	1,338	1,370	1,404	1,436	1,475	1,527	1,588	1,647	1,709	1,769	1,466	1,525	1,710	1,788	1,999

To Order Select Below

1. Series/Arm/Back/Style

	F261
F4 Standard Height, Mesh Back and Knit Seat Medium Back, Arm	
F161	
F4 Standard Height, Mesh Back and Knit Seat Medium Back, Armless	
F262	
F4 Standard Height, Mesh Back and Upholstered Seat Medium Back, Arm	
F162	
F4 Standard Height, Mesh Back and Upholstered Seat Medium Back, Armless	

2. Casters

	Black Casters
BC	BLACK CASTERS
BS	BLACK SOFT CASTERS +45
	Chrome Casters
CC	CHROME TRIM CASTERS +101
CS	CHROME TRIM SOFT CASTERS +127
	Gray Casters
GC	GRAY CASTERS +28
GS	GRAY SOFT CASTERS +54

3. Arm Cap

	Polyurethane
A1	BLACK
A2	GRAY
	Wood
81	WHITE OAK +225
85	WALNUT +225
	Aluminum
70	ALUMINUM +82
Aluminum arm caps match the chosen frame finish	

4. Base Frame Finish

	Standard Powder Coated Metal	+101
BL	BLUE	
BM	BLACK MATTE	
BR	BRASS	
BT	BLACK TWILIGHT	
CP	CHAMPAGNE	
DB	DARK BRONZE	
DG	DARK GRAY	
DP	DUSTY PINK	
FG	FOREST GREEN	
LG	LIGHT GRAY	
MG	MEADOW GREEN	
MK	MILK	
MS	METALLIC SILVER	
	Polished Metal	
AL	POLISHED ALUMINUM	

5. Back Frame/Trim Color

	Back Frame
B1	BLACK
B2	GRAY
B3	WHITE
	Trim Color
T01	CHROME CYLINDER, BLACK CAP, BUTTON
T11	ALL BLACK
T22	ALL GRAY
T31	WHITE CYLINDER, BLACK CAP, BUTTON
T32	WHITE CYLINDER, GRAY CAP, BUTTON

6. Options

	Options
HL	HEIGHT LOCK
CT	CONTRASTING THREAD

7. Back/Seat Choice

	Mesh Back Color
M01	BLACK
M02	GRAPHITE
M03	SMOKE
M05	WHITE
M13	POPPY
M15	MIDNIGHT BLUE
	Knit Seat Color
K01	BLACK
K02	GRAPHITE
K03	SMOKE
K13	POPPY
K15	MIDNIGHT BLUE
M22	BLACK/SMOKE
M23	BLACK/BRONZE
M26	BLACK/MIDNIGHT BLUE
M27	BLACK/RED
M28	WHITE/SMOKE
K22	BLACK/SMOKE
K23	BLACK/BRONZE
K26	BLACK/MIDNIGHT BLUE
K27	BLACK/RED

Upholstery
See general information section for details on textile program and COM/COL information.

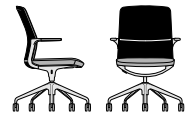
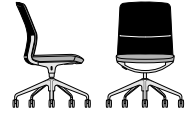
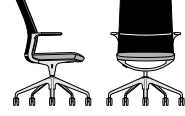
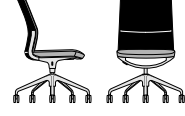

F4

STANDARD HEIGHT: UPHOLSTERED BACK/KNIT SEAT





TITLE	SERIES	ARM	BACK	UPH	HEIGHT	DIMENSIONS	YDG	SQFT	Textile Upholstery Grades												Leather Upholstery Grades						
									COM	COL	COM	A	B	COL	C	D	E	F	G	H	I	J	K	L	M	W	X
Standard Height, Upholstered Back and Knit Seat, Medium Back, Arm 	F	2	6	3		24W x 26D x 36 - 41H	0.8	11	1,643	1,700	1,733	1,762	1,793	1,825	1,860	1,895	1,935	1,987	2,049	2,112	2,172	2,235	1,950	2,024	2,262	2,363	2,592
Standard Height, Upholstered Back and Knit Seat, Medium Back, Armless 	F	1	6	3		19.5W x 26D x 36 - 41H	0.8	11	1,617	1,674	1,706	1,736	1,767	1,799	1,833	1,869	1,909	1,960	2,022	2,085	2,146	2,209	1,924	1,998	2,235	2,336	2,566
Standard Height, Upholstered Back and Knit Seat, High Back, Arm 	F	2	8	3		24W x 26D x 38.5 - 43.5H	1	15	1,758	1,831	1,871	1,910	1,952	1,993	2,036	2,080	2,133	2,199	2,281	2,361	2,440	2,520	2,066	2,139	2,379	2,478	2,708
Standard Height, Upholstered Back and Knit Seat, High Back, Armless 	F	1	8	3		19.5W x 26D x 38.5 - 43.5H	1	15	1,731	1,805	1,845	1,884	1,926	1,967	2,010	2,054	2,106	2,172	2,254	2,335	2,414	2,494	2,040	2,113	2,353	2,452	2,682

To Order Select Below





1. Series/Arm/Back/Style

	
F263	F4 Standard Height, Upholstered Back and Knit Seat Medium Back, Arm
F163	F4 Standard Height, Upholstered Back and Knit Seat Medium Back, Armless
F283	F4 Standard Height, Upholstered Back and Knit Seat High Back, Arm
F183	F4 Standard Height, Upholstered Back and Knit Seat High Back, Armless

2. Casters

		Black Casters
BC	BLACK CASTERS	
BS	BLACK SOFT CASTERS	+45
	Chrome Casters	
CC	CHROME TRIM CASTERS	+101
CS	CHROME TRIM SOFT CASTERS	+127
	Gray Casters	
GC	GRAY CASTERS	+28
GS	GRAY SOFT CASTERS	+54

3. Arm Cap



		Polyurethane
A1	BLACK	
A2	GRAY	
	Wood	
81	WHITE OAK	+225
85	WALNUT	+225
	Aluminum	
70	ALUMINUM	+82

Aluminum arm caps match the chosen frame finish



4. Base Frame Finish

		Standard Powder Coated Metal	+101
BL	BLUE	NK	NICKEL
BM	BLACK MATTE	NV	NAVY
BR	BRASS	OR	ORANGE
BT	BLACK TWILIGHT	PY	PALE YELLOW
CP	CHAMPAGNE	RD	RED
DB	DARK BRONZE	RO	RED ORANGE
DG	DARK GRAY	RR	RUSTY RED
DP	DUSTY PINK	SB	SOFT BLUE
FG	FOREST GREEN	SD	SAND
LG	LIGHT GRAY	TC	TERRACOTTA
MG	MEADOW GREEN	TP	TAUPE
MK	MILK	TS	TEXTURED SLATE
MS	METALLIC SILVER	YL	YELLOW
	Polished Metal		
AL	POLISHED ALUMINUM		

5. Trim Color

		Trim Color
		CHROME CYLINDER, BLACK CAP, BUTTON
T01		
T11		ALL BLACK
T22		ALL GRAY
		WHITE CYLINDER, BLACK CAP, BUTTON
T31		
		WHITE CYLINDER, GRAY CAP, BUTTON
T32		

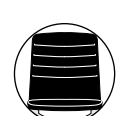

6. Options

		Options
HL	HEIGHT LOCK	
	CONTRASTING THREAD	
CT		
	Decorative Upholstery	
D1	CHANNEL	+140
D2	LOOP	+140

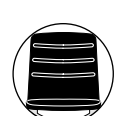
Channel





Loop

7. Back/Seat Choice

		Knit Seat Color	
K01	BLACK	K22	BLACK/SMOKE
K02	GRAPHITE	K23	BLACK/BRONZE
K03	SMOKE	K26	BLACK/MIDNIGHT BLUE
K13	POPPY	K27	BLACK/RED
K15	MIDNIGHT BLUE		
	Upholstery		
	See general information section for details on textile program and COM/COL information.		

F4

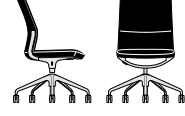
STANDARD HEIGHT: FULLY UPHOLSTERED

TITLE	SERIES	ARM	BACK	UPH	HEIGHT	DIMENSIONS	YDG	SQFT	Textile Upholstery Grades										Leather Upholstery Grades								
									COM	COL	COM	A	B	COL	C	D	E	F	G	H	I	J	K	L	M	W	X
Standard Height, Fully Upholstered, Medium Back, Arm 	F	2	6	4		24W x 26D x 36 - 41H	1.6	20	1,643	1,758	1,821	1,882	1,944	2,007	2,076	2,142	2,224	2,331	2,456	2,581	2,703	2,829	2,170	2,304	2,729	2,905	3,346
Standard Height, Fully Upholstered, Medium Back, Armless 	F	1	6	4		19.5W x 26D x 36 - 41H	1.6	20	1,617	1,731	1,794	1,855	1,917	1,980	2,050	2,116	2,198	2,305	2,430	2,555	2,676	2,802	2,144	2,277	2,703	2,879	3,320
Standard Height, Fully Upholstered, High Back, Arm 	F	2	8	4		24W x 26D x 38.5 - 43.5H	1.8	23	1,758	1,889	1,960	2,031	2,100	2,172	2,251	2,332	2,423	2,544	2,686	2,829	2,970	3,112	2,289	2,420	2,846	3,023	3,463
Standard Height, Fully Upholstered, High Back, Armless 	F	1	8	4		19.5W x 26D x 38.5 - 43.5H	1.8	23	1,731	1,863	1,934	2,004	2,074	2,146	2,225	2,306	2,397	2,518	2,660	2,802	2,944	3,086	2,263	2,394	2,819	2,997	3,437

To Order Select Below

1. Series/Arm/Back/Style

- F264
F4 Standard Height, Fully Upholstered Medium Back, Arm
- F164
F4 Standard Height, Fully Upholstered Medium Back, Armless
- F284
F4 Standard Height, Fully Upholstered High Back, Arm
- F184
F4 Standard Height, Fully Upholstered High Back, Armless

Dual Upholstery

DF DUAL UPHOLSTERY

2. Casters

Black Casters

BC BLACK CASTERS
BS BLACK SOFT CASTERS **+45**

Chrome Casters

CC CHROME TRIM CASTERS **+101**
CS CHROME TRIM SOFT CASTERS **+127**

Gray Casters

GC GRAY CASTERS **+28**
GS GRAY SOFT CASTERS **+54**

3. Arm Cap

Polyurethane

A1 BLACK
A2 GRAY

Wood

81 WHITE OAK **+225**
85 WALNUT **+225**

Aluminum

70 ALUMINUM **+82**

Aluminum arm caps match the chosen frame finish

4. Base Frame Finish

Standard Powder Coated Metal **+101**

BL BLUE
BM BLACK MATTE
BR BRASS
BT BLACK TWILIGHT
CP CHAMPAGNE
DB DARK BRONZE
DG DARK GRAY
DP DUSTY PINK
FG FOREST GREEN
LG LIGHT GRAY
MG MEADOW GREEN
MK MILK
MS METALLIC SILVER

Polished Metal

AL POLISHED ALUMINUM

5. Trim Color

Trim Color

T01 CHROME CYLINDER, BLACK CAP, BUTTON
T11 ALL BLACK
T22 ALL GRAY
T31 WHITE CYLINDER, BLACK CAP, BUTTON
T32 WHITE CYLINDER, GRAY CAP, BUTTON

6. Options

Options

HL HEIGHT LOCK
CT CONTRASTING THREAD

Decorative Upholstery

D1 CHANNEL **+140**
D2 LOOP **+140**

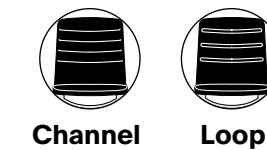

7. Back/Seat Choice



Upholstery

See general information section for details on textile program and COM/COL information.

When pricing models with more than one fabric, the higher grade fabric will determine the overall grade of the specific product.

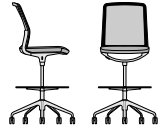

F4

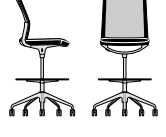
COUNTER STOOL: MESH BACK



TITLE	SERIES	ARM	BACK	UPH	HEIGHT	DIMENSIONS	YDG	SQFT	Textile Upholstery Grades												Leather Upholstery Grades							
									COM	COL	COM	A	B	COL	C	D	E	F	G	H	I	J	K	L	M	W	X	Y
Counter Stool, Mesh Back and Knit Seat, Medium Back, Arm 	F	2	6	1	M	24W x 26D x 42.25 - 49.75H	0	0	1,415																			
Counter Stool, Mesh Back and Knit Seat, Medium Back, Armless 	F	1	6	1	M	19.5W x 26D x 42.25 - 49.75H	0	0	1,389																			
Counter Stool, Mesh Back and Upholstered Seat, Medium Back, Arm 	F	2	6	2	M	24W x 26D x 42.25 - 49.75H	0.8	9	1,380	1,434	1,466	1,495	1,524	1,556	1,590	1,622	1,661	1,713	1,773	1,833	1,895	1,955	1,652	1,710	1,896	1,974	2,185	
Counter Stool, Mesh Back and Upholstered Seat, Medium Back, Armless 	F	1	6	2	M	19.5W x 26D x 42.25 - 49.75H	0.8	9	1,353	1,408	1,440	1,469	1,497	1,530	1,563	1,596	1,635	1,686	1,747	1,807	1,869	1,929	1,625	1,684	1,870	1,948	2,159	

To Order Select Below



1. Series/Arm/Back/Style

	
F261M	F4 Counter Stool, Mesh Back and Knit Seat Medium Back, Arm
F161M	F4 Counter Stool, Mesh Back and Knit Seat Medium Back, Armless
F262M	F4 Counter Stool, Mesh Back and Upholstered Seat Medium Back, Arm
F162M	F4 Counter Stool, Mesh Back and Upholstered Seat Medium Back, Armless

2. Casters

	Black Casters
BC	BLACK CASTERS
BS	BLACK SOFT CASTERS +45
	Chrome Casters
CC	CHROME TRIM CASTERS +101
CS	CHROME TRIM SOFT CASTERS +127
	Gray Casters
GC	GRAY CASTERS +28
GS	GRAY SOFT CASTERS +54

3. Arm Cap



	Polyurethane
A1	BLACK
A2	GRAY
	Wood
81	WHITE OAK +225
85	WALNUT +225
	Aluminum
70	ALUMINUM +82

Aluminum arm caps match the chosen frame finish

4. Base Frame Finish

	Standard Powder Coated Metal	+101	
BL	BLUE	NK	NICKEL
BM	BLACK MATTE	NV	NAVY
BR	BRASS	OR	ORANGE
BT	BLACK TWILIGHT	PY	PALE YELLOW
CP	CHAMPAGNE	RD	RED
DB	DARK BRONZE	RO	RED ORANGE
DG	DARK GRAY	RR	RUSTY RED
DP	DUSTY PINK	SB	SOFT BLUE
FG	FOREST GREEN	SD	SAND
LG	LIGHT GRAY	TC	TERRACOTTA
MG	MEADOW GREEN	TP	TAUPE
MK	MILK	TS	TEXTURED SLATE
MS	METALLIC SILVER	YL	YELLOW
	Polished Metal		
AL	POLISHED ALUMINUM		



5. Back Frame/Trim Color

	Back Frame
B1	BLACK
B2	GRAY
B3	WHITE
	Trim Color
T01	CHROME CYLINDER, BLACK CAP, BUTTON
T11	ALL BLACK
T22	ALL GRAY
T31	WHITE CYLINDER, BLACK CAP, BUTTON
T32	WHITE CYLINDER, GRAY CAP, BUTTON

6. Options

	Options
HL	HEIGHT LOCK
CT	CONTRASTING THREAD

7. Back/Seat Choice

	Mesh Back Color		
M01	BLACK	M22	BLACK/SMOKE
M02	GRAPHITE	M23	BLACK/BRONZE
M03	SMOKE	M26	BLACK/MIDNIGHT BLUE
M05	WHITE	M27	BLACK/RED
M13	POPPY	M28	WHITE/SMOKE
M15	MIDNIGHT BLUE		
	Knit Seat Color		
K01	BLACK	K22	BLACK/SMOKE
K02	GRAPHITE	K23	BLACK/BRONZE
K03	SMOKE	K26	BLACK/MIDNIGHT BLUE
K13	POPPY	K27	BLACK/RED
K15	MIDNIGHT BLUE		

Upholstery

See general information section for details on textile program and COM/COL information.

F4

COUNTER STOOL: UPHOLSTERED BACK/KNIT SEAT

TITLE	SERIES	ARM	BACK	UPH	HEIGHT	DIMENSIONS	YDG	SQFT	Textile Upholstery Grades												Leather Upholstery Grades						
									COM	COL	COM	A	B	COL	C	D	E	F	G	H	I	J	K	L	M	W	X
Counter Stool, Upholstered Back and Knit Seat, Medium Back, Arm	F	2	6	3	M	24W x 26D x 42.25 - 49.75H	0.8	11	1,803	1,860	1,892	1,922	1,953	1,985	2,019	2,055	2,095	2,146	2,208	2,271	2,332	2,395	2,109	2,184	2,421	2,522	2,752
Counter Stool, Upholstered Back and Knit Seat, Medium Back, Armless	F	1	6	3	M	19.5W x 26D x 42.25 - 49.75H	0.8	11	1,777	1,833	1,866	1,895	1,927	1,958	1,993	2,029	2,069	2,120	2,182	2,245	2,306	2,369	2,083	2,158	2,395	2,496	2,726
Counter Stool, Upholstered Back and Knit Seat, High Back, Arm	F	2	8	3	M	24W x 26D x 44.75 - 52.25H	1	15	1,917	1,991	2,031	2,070	2,112	2,153	2,196	2,240	2,292	2,358	2,440	2,521	2,600	2,680	2,226	2,298	2,539	2,638	2,868
Counter Stool, Upholstered Back and Knit Seat, High Back, Armless	F	1	8	3	M	19.5W x 26D x 44.75 - 52.25H	1	15	1,891	1,965	2,004	2,043	2,085	2,126	2,169	2,213	2,266	2,332	2,414	2,495	2,574	2,653	2,200	2,272	2,513	2,611	2,841

To Order Select Below

1. Series/Arm/Back/Style

	F263M	F4 Counter Stool, Upholstered Back and Knit Seat Medium Back, Arm
	F163M	F4 Counter Stool, Upholstered Back and Knit Seat Medium Back, Armless
	F283M	F4 Counter Stool, Upholstered Back and Knit Seat High Back, Arm
	F183M	F4 Counter Stool, Upholstered Back and Knit Seat High Back, Armless

2. Casters

	Black Casters
BC	BLACK CASTERS
BS	BLACK SOFT CASTERS +45
	Chrome Casters
CC	CHROME TRIM CASTERS +101
CS	CHROME TRIM SOFT CASTERS +127
	Gray Casters
GC	GRAY CASTERS +28
GS	GRAY SOFT CASTERS +54

3. Arm Cap

	Polyurethane
A1	BLACK
A2	GRAY
	Wood
81	WHITE OAK +225
85	WALNUT +225
	Aluminum
70	ALUMINUM +82

Aluminum arm caps match the chosen frame finish

4. Base Frame Finish

	Standard Powder Coated Metal	+101
BL	BLUE	
BM	BLACK MATTE	
BR	BRASS	
BT	BLACK TWILIGHT	
CP	CHAMPAGNE	
DB	DARK BRONZE	
DG	DARK GRAY	
DP	DUSTY PINK	
FG	FOREST GREEN	
LG	LIGHT GRAY	
MG	MEADOW GREEN	
MK	MILK	
MS	METALLIC SILVER	
	Polished Metal	
AL	POLISHED ALUMINUM	

5. Trim Color

	Trim Color
	CHROME CYLINDER, BLACK CAP, BUTTON
T01	
T11	ALL BLACK
T22	ALL GRAY
	WHITE CYLINDER, BLACK CAP, BUTTON
T31	
	WHITE CYLINDER, GRAY CAP, BUTTON
T32	

6. Options





	Options
HL	HEIGHT LOCK
	CONTRASTING THREAD
CT	
	Decorative Upholstery
D1	CHANNEL +140
D2	LOOP +140
	Channel
	Loop

7. Back/Seat Choice

	Knit Seat Color
K01	BLACK
K02	GRAPHITE
K03	SMOKE
K13	POPPY
K15	MIDNIGHT BLUE
K22	BLACK/SMOKE
K23	BLACK/BRONZE
K26	BLACK/MIDNIGHT BLUE
K27	BLACK/RED
	Upholstery
	See general information section for details on textile program and COM/COL information.



F4

COUNTER STOOL: FULLY UPHOLSTERED



TITLE	SERIES	ARM	BACK	UPH	HEIGHT	DIMENSIONS	YDG	SQFT	Textile Upholstery Grades										Leather Upholstery Grades								
									COM	COL	COM	A	B	COL	C	D	E	F	G	H	I	J	K	L	M	W	X
 Counter Stool, Fully Upholstered, Medium Back, Arm	F	2	6	4	M	24W x 26D x 42.25 - 49.75H	1.6	20	1,803	1,917	1,980	2,041	2,103	2,166	2,235	2,302	2,384	2,491	2,616	2,741	2,862	2,988	2,330	2,463	2,889	3,065	3,506
 Counter Stool, Fully Upholstered, Medium Back, Armless	F	1	6	4	M	19.5W x 26D x 42.25 - 49.75H	1.6	20	1,777	1,891	1,954	2,015	2,077	2,140	2,209	2,275	2,357	2,464	2,589	2,714	2,836	2,962	2,304	2,437	2,862	3,039	3,480
 Counter Stool, Fully Upholstered, High Back, Arm	F	2	8	4	M	24W x 26D x 44.75 - 52.25H	1.8	23	1,917	2,049	2,120	2,190	2,260	2,332	2,411	2,492	2,583	2,704	2,846	2,988	3,130	3,272	2,449	2,580	3,005	3,183	3,623
 Counter Stool, Fully Upholstered, High Back, Armless	F	1	8	4	M	19.5W x 26D x 44.75 - 52.25H	1.8	23	1,891	2,022	2,094	2,164	2,233	2,306	2,385	2,465	2,557	2,678	2,819	2,962	3,104	3,246	2,422	2,554	2,979	3,156	3,596

To Order Select Below



1. Series/Arm/Back/Style

-   **Dual Upholstery**
- F264M
F4 Counter Stool, Fully Upholstered Medium Back, Arm
- F164M
F4 Counter Stool, Fully Upholstered Medium Back, Armless
- F284M
F4 Counter Stool, Fully Upholstered High Back, Arm
- F184M
F4 Counter Stool, Fully Upholstered High Back, Armless

2. Casters

-  **Black Casters**
- BC BLACK CASTERS
- BS BLACK SOFT CASTERS **+45**
-  **Chrome Casters**
- CC CHROME TRIM CASTERS **+101**
- CS CHROME TRIM SOFT CASTERS **+127**
-  **Gray Casters**
- GC GRAY CASTERS **+28**
- GS GRAY SOFT CASTERS **+54**

3. Arm Cap

-  **Polyurethane**
 - A1 BLACK
 - A2 GRAY
 -  **Wood**
 - 81 WHITE OAK **+225**
 - 85 WALNUT **+225**
 -  **Aluminum**
 - 70 ALUMINUM **+82**
- Aluminum arm caps match the chosen frame finish



4. Base Frame Finish

-  **Standard Powder Coated Metal** **+101**
- BL BLUE
- BM BLACK MATTE
- BR BRASS
- BT BLACK TWILIGHT
- CP CHAMPAGNE
- DB DARK BRONZE
- DG DARK GRAY
- DP DUSTY PINK
- FG FOREST GREEN
- LG LIGHT GRAY
- MG MEADOW GREEN
- MK MILK
- MS METALLIC SILVER
-  **Polished Metal**
- AL POLISHED ALUMINUM
- NK NICKEL
- NV NAVY
- OR ORANGE
- PY PALE YELLOW
- RD RED
- RO RED ORANGE
- RR RUSTY RED
- SB SOFT BLUE
- SD SAND
- TC TERRACOTTA
- TP TAUPE
- TS TEXTURED SLATE
- YL YELLOW

5. Trim Color

-  **Trim Color**
- T01 CHROME CYLINDER, BLACK CAP, BUTTON
- T11 ALL BLACK
- T22 ALL GRAY
- T31 WHITE CYLINDER, BLACK CAP, BUTTON
- T32 WHITE CYLINDER, GRAY CAP, BUTTON

6. Options

-  **Options**
- HL HEIGHT LOCK
- CT CONTRASTING THREAD
-  **Decorative Upholstery**
- D1 CHANNEL **+140**
- D2 LOOP **+140**

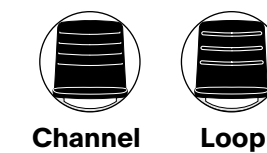



7. Back/Seat Choice

-  **Upholstery**
- See general information section for details on textile program and COM/COL information.**
- When pricing models with more than one fabric, the higher grade fabric will determine the overall grade of the specific product.

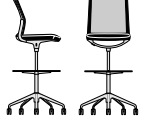

F4

BAR STOOL: MESH BACK



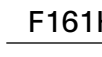
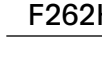
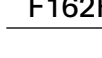

TITLE	SERIES	ARM	BACK	UPH	HEIGHT	DIMENSIONS	YDG	SQFT	Textile Upholstery Grades												Leather Upholstery Grades							
									COM	COL	COM	A	B	COL	C	D	E	F	G	H	I	J	K	L	M	W	X	Y
Bar Stool, Mesh Back and Knit Seat, Medium Back, Arm 	F	2	6	1	H	24W x 26D x 44.75 - 54.75H	0	0	1,415																			
Bar Stool, Mesh Back and Knit Seat, Medium Back, Armless 	F	1	6	1	H	19.5W x 26D x 44.75 - 54.75H	0	0	1,389																			
Bar Stool, Mesh Back and Upholstered Seat, Medium Back, Arm 	F	2	6	2	H	24W x 26D x 44.75 - 54.75H	0.8	9	1,380	1,434	1,466	1,495	1,524	1,556	1,590	1,622	1,661	1,713	1,773	1,833	1,895	1,955	1,652	1,710	1,896	1,974	2,185	
Bar Stool, Mesh Back and Upholstered Seat, Medium Back, Armless 	F	1	6	2	H	19.5W x 26D x 44.75 - 54.75H	0.8	9	1,353	1,408	1,440	1,469	1,497	1,530	1,563	1,596	1,635	1,686	1,747	1,807	1,869	1,929	1,625	1,684	1,870	1,948	2,159	

To Order Select Below





1. Series/Arm/Back/Style

-   F261H
F4 Bar Stool, Mesh Back and Knit Seat Medium Back, Arm
-  F161H
F4 Bar Stool, Mesh Back and Knit Seat Medium Back, Armless
-  F262H
F4 Bar Stool, Mesh Back and Upholstered Seat Medium Back, Arm
-  F162H
F4 Bar Stool, Mesh Back and Upholstered Seat Medium Back, Armless

2. Casters

-   **Black Casters**
BC BLACK CASTERS
BS BLACK SOFT CASTERS **+45**
-  **Chrome Casters**
CC CHROME TRIM CASTERS **+101**
CS CHROME TRIM SOFT CASTERS **+127**
-  **Gray Casters**
GC GRAY CASTERS **+28**
GS GRAY SOFT CASTERS **+54**



3. Arm Cap

-   **Polyurethane**
A1 BLACK
A2 GRAY
-  **Wood**
81 WHITE OAK **+225**
85 WALNUT **+225**
-  **Aluminum**
70 ALUMINUM **+82**
Aluminum arm caps match the chosen frame finish



4. Base Frame Finish

-   **Standard Powder Coated Metal** **+101**
BL BLUE
BM BLACK MATTE
BR BRASS
BT BLACK TWILIGHT
CP CHAMPAGNE
DB DARK BRONZE
DG DARK GRAY
DP DUSTY PINK
FG FOREST GREEN
LG LIGHT GRAY
MG MEADOW GREEN
MK MILK
MS METALLIC SILVER
-  **Polished Metal**
AL POLISHED ALUMINUM





5. Back Frame/Trim Color

-   **Back Frame**
B1 BLACK
B2 GRAY
B3 WHITE
-  **Trim Color**
T01 CHROME CYLINDER, BLACK CAP, BUTTON
T11 ALL BLACK
T22 ALL GRAY
T31 WHITE CYLINDER, BLACK CAP, BUTTON
T32 WHITE CYLINDER, GRAY CAP, BUTTON

6. Options





-   **Options**
HL HEIGHT LOCK
CT CONTRASTING THREAD

7. Back/Seat Choice

-   **Mesh Back Color**
M01 BLACK
M02 GRAPHITE
M03 SMOKE
M05 WHITE
M13 POPPY
M15 MIDNIGHT BLUE
M22 BLACK/SMOKE
M23 BLACK/BRONZE
M26 BLACK/MIDNIGHT BLUE
M27 BLACK/RED
M28 WHITE/SMOKE
-  **Knit Seat Color**
K01 BLACK
K02 GRAPHITE
K03 SMOKE
K13 POPPY
K15 MIDNIGHT BLUE
K22 BLACK/SMOKE
K23 BLACK/BRONZE
K26 BLACK/MIDNIGHT BLUE
K27 BLACK/RED
-  **Upholstery**
See general information section for details on textile program and COM/COL information.









F4

BAR STOOL: UPHOLSTERED BACK/KNIT SEAT





TITLE	SERIES	ARM	BACK	UPH	HEIGHT	DIMENSIONS	YDG	SQFT	Textile Upholstery Grades												Leather Upholstery Grades						
									COM	COL	COM	A	B	COL	C	D	E	F	G	H	I	J	K	L	M	W	X
Bar Stool, Upholstered Back and Knit Seat, Medium Back, Arm 	F	2	6	3	H	24W x 26D x 44.75 - 54.75H	0.8	11	1,803	1,860	1,892	1,922	1,953	1,985	2,019	2,055	2,095	2,146	2,208	2,271	2,332	2,395	2,109	2,184	2,421	2,522	2,752
Bar Stool, Upholstered Back and Knit Seat, Medium Back, Armless 	F	1	6	3	H	19.5W x 26D x 44.75 - 54.75H	0.8	11	1,777	1,833	1,866	1,895	1,927	1,958	1,993	2,029	2,069	2,120	2,182	2,245	2,306	2,369	2,083	2,158	2,395	2,496	2,726
Bar Stool, Upholstered Back and Knit Seat, High Back, Arm 	F	2	8	3	H	24W x 26D x 49.25 - 57.25H	1	15	1,917	1,991	2,031	2,070	2,112	2,153	2,196	2,240	2,292	2,358	2,440	2,521	2,600	2,680	2,226	2,298	2,539	2,638	2,868
Bar Stool, Upholstered Back and Knit Seat, High Back, Armless 	F	1	8	3	H	19.5W x 26D x 49.25 - 57.25H	1	15	1,891	1,965	2,004	2,043	2,085	2,126	2,169	2,213	2,266	2,332	2,414	2,495	2,574	2,653	2,200	2,272	2,513	2,611	2,841

To Order Select Below





1. Series/Arm/Back/Style

		F263H F4 Bar Stool, Upholstered Back and Knit Seat Medium Back, Arm
		F163H F4 Bar Stool, Upholstered Back and Knit Seat Medium Back, Armless
		F283H F4 Bar Stool, Upholstered Back and Knit Seat High Back, Arm
		F183H F4 Bar Stool, Upholstered Back and Knit Seat High Back, Armless

2. Casters

		Black Casters
BC	BLACK CASTERS	
BS	BLACK SOFT CASTERS	+45
	Chrome Casters	
CC	CHROME TRIM CASTERS	+101
CS	CHROME TRIM SOFT CASTERS	+127
	Gray Casters	
GC	GRAY CASTERS	+28
GS	GRAY SOFT CASTERS	+54

3. Arm Cap



		Polyurethane
A1	BLACK	
A2	GRAY	
	Wood	
81	WHITE OAK	+225
85	WALNUT	+225
	Aluminum	
70	ALUMINUM	+82

Aluminum arm caps match the chosen frame finish



4. Base Frame Finish

		Standard Powder Coated Metal	+101
BL	BLUE	NK	NICKEL
BM	BLACK MATTE	NV	NAVY
BR	BASS	OR	ORANGE
BT	BLACK TWILIGHT	PY	PALE YELLOW
CP	CHAMPAGNE	RD	RED
DB	DARK BRONZE	RO	RED ORANGE
DG	DARK GRAY	RR	RUSTY RED
DP	DUSTY PINK	SB	SOFT BLUE
FG	FOREST GREEN	SD	SAND
LG	LIGHT GRAY	TC	TERRACOTTA
MG	MEADOW GREEN	TP	TAUPE
MK	MILK	TS	TEXTURED SLATE
MS	METALLIC SILVER	YL	YELLOW
	Polished Metal		
AL	POLISHED ALUMINUM		



5. Trim Color

		Trim Color
		CHROME CYLINDER, BLACK CAP, BUTTON
T01		
T11		ALL BLACK
T22		ALL GRAY
		WHITE CYLINDER, BLACK CAP, BUTTON
T31		
		WHITE CYLINDER, GRAY CAP, BUTTON
T32		

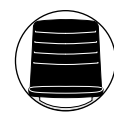
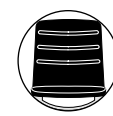
6. Options





		Options
HL	HEIGHT LOCK	
	CONTRASTING THREAD	
CT		
	Decorative Upholstery	
D1	CHANNEL	+140
D2	LOOP	+140
		Channel
		Loop

7. Back/Seat Choice

		Knit Seat Color	
K01	BLACK	K22	BLACK/SMOKE
K02	GRAPHITE	K23	BLACK/BRONZE
K03	SMOKE	K26	BLACK/MIDNIGHT BLUE
K13	POPPY	K27	BLACK/RED
K15	MIDNIGHT BLUE		
	Upholstery		
	See general information section for details on textile program and COM/COL information.		

F4

BAR STOOL: FULLY UPHOLSTERED

TITLE	SERIES	ARM	BACK	UPH	HEIGHT	DIMENSIONS	YDG	SQFT	Textile Upholstery Grades											Leather Upholstery Grades							
									COM	COL	COM	A	B	COL	C	D	E	F	G	H	I	J	K	L	M	W	X
 Bar Stool, Fully Upholstered, Medium Back, Arm	F	2	6	4	H	24W x 26D x 44.75 - 54.75H	1.6	20	1,803	1,917	1,980	2,041	2,103	2,166	2,235	2,302	2,384	2,491	2,616	2,741	2,862	2,988	2,330	2,463	2,889	3,065	3,506
 Bar Stool, Fully Upholstered, Medium Back, Armless	F	1	6	4	H	19.5W x 26D x 44.75 - 54.75H	1.6	20	1,777	1,891	1,954	2,015	2,077	2,140	2,209	2,275	2,357	2,464	2,589	2,714	2,836	2,962	2,304	2,437	2,862	3,039	3,480
 Bar Stool, Fully Upholstered, High Back, Arm	F	2	8	4	H	24W x 26D x 49.25 - 57.25H	1.8	23	1,917	2,049	2,120	2,190	2,260	2,332	2,411	2,492	2,583	2,704	2,846	2,988	3,130	3,272	2,449	2,580	3,005	3,183	3,623
 Bar Stool, Fully Upholstered, High Back, Armless	F	1	8	4	H	19.5W x 26D x 49.25 - 57.25H	1.8	23	1,891	2,022	2,094	2,164	2,233	2,306	2,385	2,465	2,557	2,678	2,819	2,962	3,104	3,246	2,422	2,554	2,979	3,156	3,596

To Order Select Below

1. Series/Arm/Back/Style

- F264H
F4 Bar Stool, Fully Upholstered Medium Back, Arm
- F164H
F4 Bar Stool, Fully Upholstered Medium Back, Armless
- F284H
F4 Bar Stool, Fully Upholstered High Back, Arm
- F184H
F4 Bar Stool, Fully Upholstered High Back, Armless

Dual Upholstery

- DF DUAL UPHOLSTERY

2. Casters

Black Casters

- BC BLACK CASTERS
- BS BLACK SOFT CASTERS **+45**

Chrome Casters

- CC CHROME TRIM CASTERS **+101**
- CS CHROME TRIM SOFT CASTERS **+127**

Gray Casters

- GC GRAY CASTERS **+28**
- GS GRAY SOFT CASTERS **+54**

3. Arm Cap

Polyurethane

- A1 BLACK
- A2 GRAY

Wood

- 81 WHITE OAK **+225**
- 85 WALNUT **+225**

Aluminum

- 70 ALUMINUM **+82**

Aluminum arm caps match the chosen frame finish

4. Base Frame Finish

Standard Powder Coated Metal **+101**

- BL BLUE
- BM BLACK MATTE
- BR BRASS
- BT BLACK TWILIGHT
- CP CHAMPAGNE
- DB DARK BRONZE
- DG DARK GRAY
- DP DUSTY PINK
- FG FOREST GREEN
- LG LIGHT GRAY
- MG MEADOW GREEN
- MK MILK
- MS METALLIC SILVER
- NK NICKEL
- NV NAVY
- OR ORANGE
- PY PALE YELLOW
- RD RED
- RO RED ORANGE
- RR RUSTY RED
- SB SOFT BLUE
- SD SAND
- TC TERRACOTTA
- TP TAUPE
- TS TEXTURED SLATE
- YL YELLOW

Polished Metal

- AL POLISHED ALUMINUM

5. Trim Color

Trim Color

- T01 CHROME CYLINDER, BLACK CAP, BUTTON
- T11 ALL BLACK
- T22 ALL GRAY
- T31 WHITE CYLINDER, BLACK CAP, BUTTON
- T32 WHITE CYLINDER, GRAY CAP, BUTTON

6. Options

Options

- HL HEIGHT LOCK
- CT CONTRASTING THREAD

Decorative Upholstery

- D1 CHANNEL **+140**
- D2 LOOP **+140**

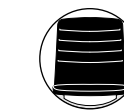

Channel

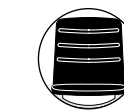

Loop

7. Back/Seat Choice

Upholstery

See general information section for details on textile program and COM/COL information.

When pricing models with more than one fabric, the higher grade fabric will determine the overall grade of the specific product.

stylex

Free Address

PRICE LIST

Effective November 01, 2023

Updated January 22, 2024

General Information

GENERAL INFORMATION

Terms

Net 30 days from date of invoice.
FOB Delanco, NJ

Damaged Shipments

All Stylex products are carefully inspected before they are packed in sturdy cartons designed to satisfy shipping requirements. Stylex is not responsible for damage in shipment. The transportation company assumes responsibility for delivering products to you in good condition when the bill of lading is signed. You protect yourself by refusing shipments showing damage or shortage until transportation company has noted on the delivery sheet the extent of damage or shortage. Concealed damage should be reported to the carrier as soon as discovered, but not later than 15 days after receiving shipment.

Return/Restocking Policy

Return shipments will not be accepted unless specifically authorized by Stylex in writing. The Return Authorization number should be clearly marked on the carton. The customer returning Stylex products is responsible for return shipping costs. Merchandise must be returned unused. Returned merchandise is subject to a 35% restocking fee.

Specials/Customs

Modifications to standard products will be considered for large runs. Contact Stylex for more information.

Design Changes

In keeping with modern manufacturing advances, Stylex reserves the right to incorporate minor modifications and design changes in products without notice.

Cancellation Policy

No charge prior to production except for inventory specifically requisitioned to fulfill the particular order. After production has begun, only actual costs incurred, including labor and material, will be billed to the customer.

WARRANTY

Except as provided below, Stylex warrants exclusively to the original Purchaser of our product that all parts, under normal use and service, will be free from defects in workmanship and material for a period of ten (10) years from the date of purchase. "Normal use and service" means that the product will be used in a typical office environment for 40-45 hours per week.

This warranty is subject to the following limitations, exclusions and provisions:

Wood components of plywood stacking chairs
(such as Brooks and Welcome)
5 years

Upholstery
(including mesh used for Click, F4, Insight, and Zephyr Mesh)
3 years

SAVA Mesh
10 years

COM Upholstery
No warranty
Stylex makes every effort to ensure that the COM Upholstery it approves is suitable for the intended use. Nevertheless, we will not warrant, and assume no responsibility for, the durability or tailoring quality of any COM or COL. If you have any concerns about the ultimate appearance of any covering, please order an upholstered sample.

Painted Stack Chair Frames
No Warranty
We will not warrant the finish of painted stack chair frames against damage from stacking. We recommend ordering chrome frames for chairs that will be stacked.

Felt Glides
No warranty
Due to the different surfaces on which felt glides may be used, we cannot warrant their durability over time.

If this product fails during normal use and service within the applicable warranty period (other than through normal wear and tear), please send a description of the relevant part and the nature of the defect, together with proof of purchase of the product, to Stylex at: Customer Service. c/o Stylex, P.O. Box 5038, Delanco, NJ 08075. PLEASE DO NOT RETURN PARTS OR THE PRODUCT TO STYLEX UNLESS INSTRUCTED TO DO SO BY STYLEX. Stylex will, at its option, either repair or replace the product or the part found defective by Stylex completely without charge for materials or labor. Purchaser may be required (at the option of Stylex) to return to Stylex at Purchaser's expense any defective part with all freight or shipping charges prepaid. The foregoing warranty shall be void if the product has been altered or repaired (other than by Stylex). The warranty does not cover damage to the product caused by accident, neglect, misuse, abuse, modification to the product by anyone other than Stylex or damage caused by use of the product for a purpose other than that for which it was designed. This warranty extends only to the original Purchaser of the product.

No Other Warranties

This warranty is in lieu of all other warranties, expressed or implied, including, but not limited to, implied warranties of merchantability and fitness for a particular purpose. The rights and remedies provided herein are the exclusive rights and remedies of the original purchaser of the product.

No Liability For Damages

In no event shall Stylex or its suppliers be responsible or liable for any special, indirect, consequential, or incidental damages. In no event shall the liability of Stylex exceed the actual purchase price paid to Stylex for the product.

Out of Warranty Products

For all products no longer covered by our warranty, please refer to our Design for Durability and Upgradability Policy. Contact Customer Service if you would like to purchase any replaceable components to further extend the life of any Stylex seating product. This warranty applies to all Stylex products purchased on April 13, 2018, and thereafter.

PRODUCT TAKE BACK PROGRAM

At Stylex, responsible stewardship of our products extends beyond their initial use. Our Product Take Back Program provides a practical solution for the end of our products' intended life cycle.

Through our partnership with ANEW, a 501(c)(3) nonprofit organization, we offer clients a comprehensive take-back solution for surplus office furniture and materials, regardless of their condition. ANEW's mission aligns with ours—to connect surplus resources with non-profits, public agencies, and underserved communities, minimizing landfill impact and maximizing corporate social responsibility.

By repurposing surplus items, we strengthen community networks and reduce environmental impact. Stylex proudly supports ANEW, integrating this partnership into our strategic sales strategy since 2014. Learn more at www.anewfound.org.

Initiate a Product Take Back through ANEW by emailing Stylex at info@stylexdesign.com. For additional end-of-life recovery options, refer to our Product Disassembly Instructions and End of Life Recovery Options documents, available in the Resources section of each product on our website. Together, let's build a sustainable future.

FREIGHT PROGRAM

Stylex offers a Guaranteed Freight Program, which provides the purchaser the ability to determine shipping and handling charges at the time of order. Freight charges will be calculated as a percentage of the net product price and added to the invoice at the time of shipment. The continental United States has been divided into three zones. Please use the map below to determine the freight charges for the product's destination. There is a minimum freight charge of \$150.

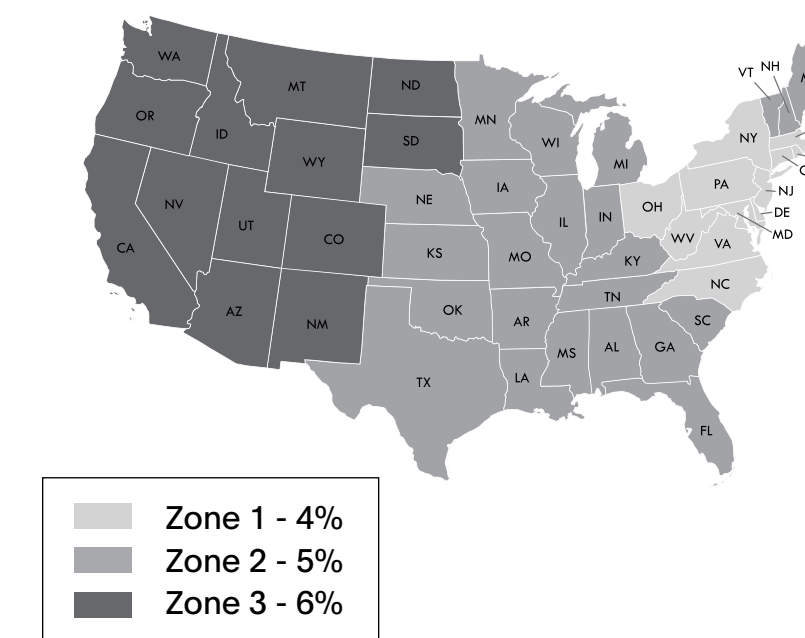

ZONE 1 - 4%

Connecticut
Delaware
New York
New Jersey
Maryland
Massachusetts
North Carolina
Ohio
Pennsylvania
Rhode Island
Virginia
Washington D.C.
West Virginia

ZONE 2 - 5%

Alabama
Arkansas
Canada, Ontario
Canada, Quebec
Florida
Georgia
Iowa
Illinois
Indiana
Kansas
Kentucky
Louisiana
Nebraska
New Hampshire
Oklahoma
Maine
Michigan
Minnesota
Missouri
Mississippi
South Carolina
Tennessee
Texas
Vermont
Wisconsin

ZONE 3 - 6%

Arizona
California
Colorado
Idaho
Montana
Nevada
New Mexico
North Dakota
Oregon
South Dakota
Utah
Washington
Wyoming

Quote Per Project

Alaska
Hawaii
Canada
(outside Ontario & Quebec)
Mexico

General Information

TEXTILE PARTNERS & APPROVALS

Textile Partners

To customize your furniture performance needs and design vision, Stylex offers a wide selection of in-graded leathers and textiles from Grades A through Y. We've partnered with leading manufacturers on the options, focusing on color, price, durability, and construction. To view our partners and explore our digital carded program with broadly approved textiles, visit [this page](#). We stand by these textiles: They're tried and tested, and will effortlessly fit into any design aesthetic.

Textile Approvals

To view Stylex Approved Textile documents to determine specific product approval status, refer to our Product Tested Textiles documents, available in the Resources section of each product on our website.

CAL 117 AND 133 COMPLIANCE

CAL 117-2013

All Stylex seating satisfies the requirements of CAL 117-2013 so long as one of our standard or in-graded textiles is applied. COM textiles cannot be so guaranteed. Please contact the supplier of COM's directly to determine the fire retardancy of any COM supplied to us.

CAL 133

Most Stylex seating can be ordered to meet the requirements of CAL 133. When ordering, simply specify "CAL 133 compliance required". The upcharge for this option is \$54 list per yard. Please refer to the COM yardage of each model to determine the number of yards required. We do frequently require full-scale burn tests in order to certify CAL 133 before an order will be accepted. Such burn tests may increase normal lead times and do carry additional charges. Please contact customer service for details.

CUSTOMER'S OWN MATERIAL/LEATHER

Customer's own material (COM) and customer's own leather (COL) will generally be upholstered at the price designated in each product's price list. Please be advised, however, that we specifically reserve the right to charge a higher price when we determine that special circumstances, such as unusual repeats or challenging materials, present themselves. All orders for custom coverings must be approved by Stylex before they will be accepted for production. To submit proposed textile for approval, please use the COM form [here](#).

Special Note:

We assume no responsibility for the durability or tailoring quality of any COM or COL. Directional covers in particular may not meet your satisfaction due to the design of certain products. Please be advised that COM and COL orders are not subject to return. If you have doubts about the ultimate appearance of certain coverings, please order a sample done with that specific COM or COL. In addition, while we inspect textiles for mill imperfections, some are difficult to recognize. We cannot be responsible for defects, color inaccuracies, dye lot variations, or other flaws.

Under no circumstances will we be responsible for COM shortages, flaws, or other such problems. Finally, it is not our responsibility to police the receipt of COM's in order to meet delivery deadlines, and we assume our customers are aware of any undue delay in the shipment of their COM textiles.

COM textile and COL leather should be sent prepaid to: Stylex

**Attn: COM/COL - [Your PO #]
740 Coopertown Road
Delanco, NJ 08075**

Clearly mark textile or leather with the dealer's name, purchase order number, and furniture model number of the item to be covered. Actual furniture orders should include the same information, as well as a description of the textile or leather, including pattern and color number, in order to provide a cross reference.

Yardage requirements shown in the price list are based on non-directional goods of 54" width. Textiles less than 54" wide or those requiring matching (stripes, prints, or large patterned designs) call for additional yardage. We will be happy to supply yardage requirements for large quantities where economies may be realized.

Add the following yardage for stripes, plaids, or patterns with repeats:

Textile Width	Plain Textile	2-14" Repeat	15-24" Repeat	25-27" Repeat	28-36" Repeat
54"	0%	10%	15%	20%	25%
50"	10%	20%	25%	30%	35%
48"	15%	25%	30%	35%	40%
45"	40%	50%	55%	60%	65%
36"	50%	60%	65%	70%	75%

COM/COL FORM

To avoid delay in processing COM orders we request that you submit a sample of your COM textile stapled to this form which can be downloaded [here](#). If a textile has a stripe or design, the size of the repeat should be indicated. Please indicate the textile supplier's name, textile number, and color. Also indicate the Stylex product on which the textile will be used.

The textile supplier must indicate on his shipping labels the dealer name and purchase order number as well as the Stylex model number.

Please Note:

No order may be entered into production or have a shipping date assigned until all related COM is received at the factory.



CENTER OF STRIPE OR DESIGN

TOP	TOP
-----	-----

1. Size of Repeat

2. Textile Supplier

3. Textile Number

4. Color

5. Stylex Product

Free Address

Contents

<hr/>		<hr/>		<hr/>	
COLORS, MATERIALS, AND FINISHES	5	BENCHES	20	TABLE TOPS	43
STATEMENT OF LINE	6	SEATS: 29H	22	CASE GOODS	46
DIMENSIONS	11	SEATS: 36H	26	FRAMES	52
POWER	12	SEATS: 42H	34	TABLES: TABLETS & FREESTANDING	56
HOW TO ORDER	17	ARMS	42	SCREENS	59
<hr/>		<hr/>		<hr/>	

CLICK THE TITLES ABOVE TO NAVIGATE THROUGH THE DOCUMENT
PRODUCT HEADERS ON SUBSEQUENT PAGES LINK BACK TO THIS PAGE

Free Address

COLORS, MATERIALS, AND FINISHES

POWDER COATED METAL

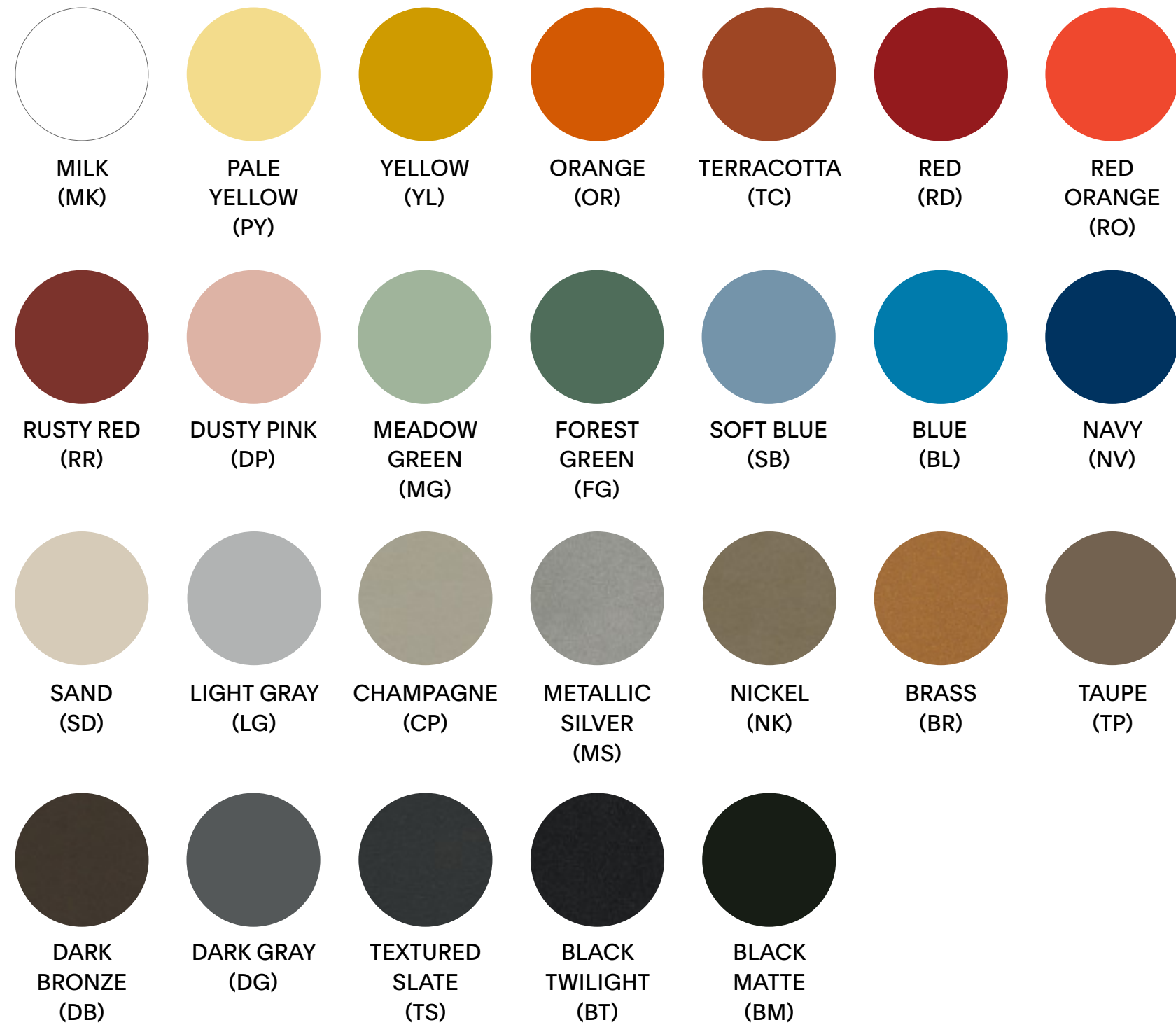

GRADE 1 WILSONART® LAMINATE FINISHES



WOOD VENEER





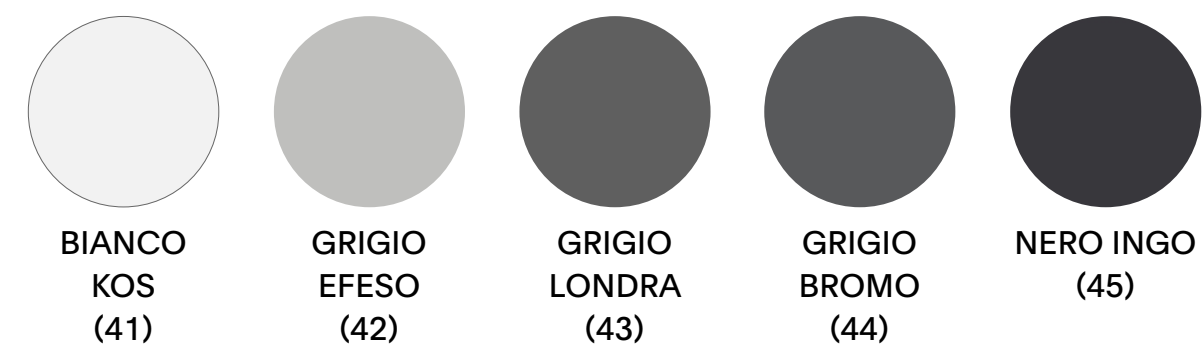



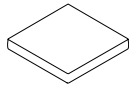
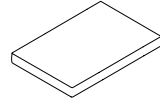
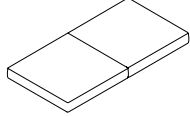
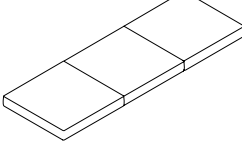
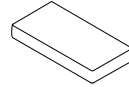
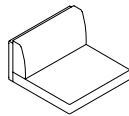
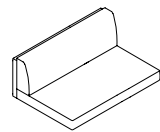
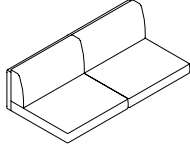
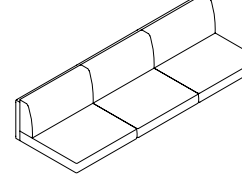
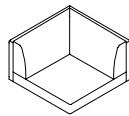
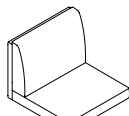
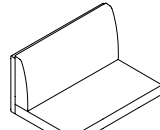
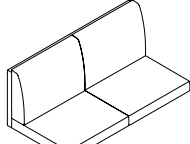
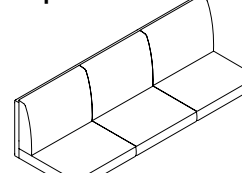
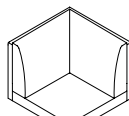
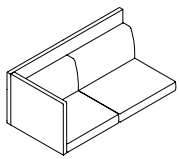
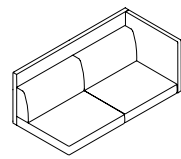
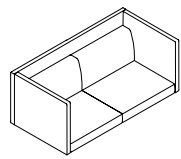

GRADE 2 FENIX® LAMINATE FINISHES

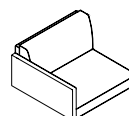
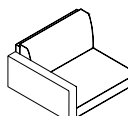
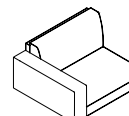
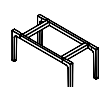
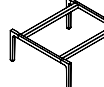
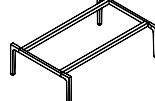
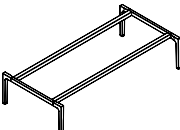
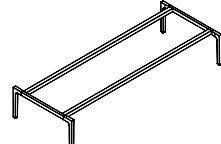
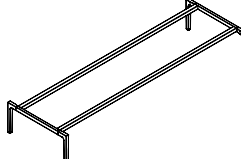

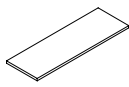
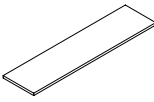
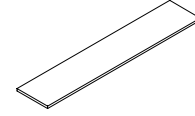
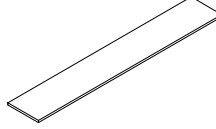
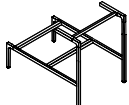
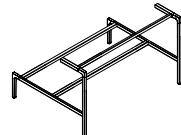
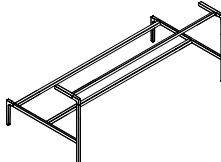
Free Address

SPECIFICATION GUIDE: STATEMENT OF LINE, SEATS AND FRAMES

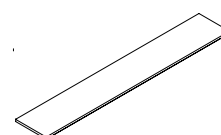
OVERVIEW SEATS							
Benches	Single	Single Plus	Double	Triple	Half		
							
Task Seats 29", 36", 42" Heights	Single	Single Plus	Double	Triple	Corner		
							
Banquette Seats 36", 42" Heights	Single	Single Plus	Double	Triple	Corner		
							
End Panels 29", 36", 42" Heights With Task or Banquette Seats	End Panel Right	End Panel Left	End Panel Both Sides Double/Triple Seat Only	Arms	2" Arm	4" Arm	6" Arm
							
Seat Height Frames 13" High 15", 30", 45" Deep	15" Long	30" Long	45" Long	60" Long	75" Long	90" Long	
							
Seat Height Table Tops 1" Thick 15", 30", 45" Deep	15" Long	30" Long	45" Long	60" Long	75" Long*	90" Long*	*75" and 90" long tops are only available in 15" deep
							
Seat with Ledge Frames 29", 36", 42" High	30" Long	60" Long	90" Long	Ledge Table Tops 1" Thick 15" Deep	30" Long	60" Long	90" Long
							

GENERAL INFORMATION

Design

Stylex / Gensler Product Design Consultant

Frames/Tables/Case Goods

A selection of wood veneer and laminate are available. Effective 5/15/23, lockers, cubbies and shelves in Grade 1 laminate utilize butt-joint construction. Please see [page 10](#) for details.

Configuration

Free Address is a kit of parts comprised of upholstered seating, case goods, and work surfaces offering integrated solutions at 29" task, 36" counter, and 42" bar heights. The customer has freedom to arrange these components on frames in order to prioritize aesthetics, cost and ease of reconfigurability. Users can address a wide variety of workstyles through configuration: short term, long term, individual or collaborative spaces. To ensure clarity when ordering, it is critical that line items should be listed in the order in which they will be arranged from left end (seated perspective) to right end wherever possible. The use of CET Designer is the preferred method for specifying this product.

Casters/Glides

Locking casters are available on tables that are larger than 15" in length and depth. Casters come in black, and are available in both hard and soft options. Casters are not available on tables with power. Glide height adjustability of seat height frames is 5/8". Glide height adjustability on tables is 1".

Ganging

All frames of the same height may be connected to one another with the use of bent sheet metal ganging brackets.

Use

Designed for indoor use only.

Performance Standards

Manufactured to comply with:
ANSI/BIFMA X5.4 Lounge Seating Tests
ANSI/BIFMA X5.5 Desk & Table Products
ANSI/BIFMA X5.9 Storage Units

Certifications

GREENGUARD Gold - Seating, Laminate Table
GREENGUARD - Privacy Panel, Wood Veneer Table
LEVEL® 1, BIFMA's sustainability certification program for furniture

Free Address

SPECIFICATION GUIDE: STATEMENT OF LINE, CASE GOODS AND TABLET TABLES

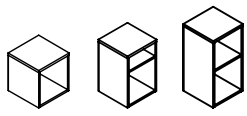
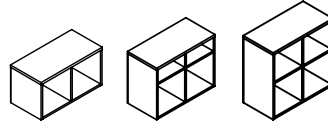
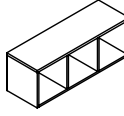
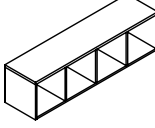
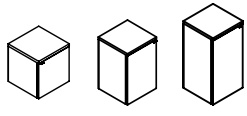
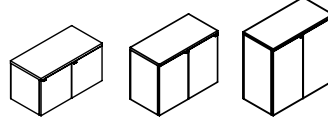
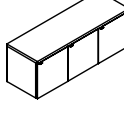
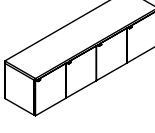
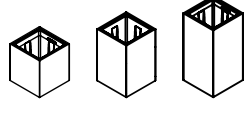
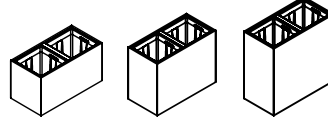
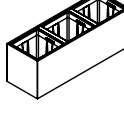
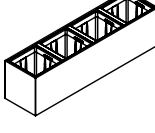
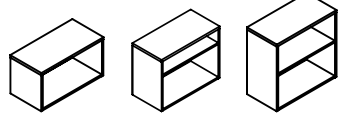
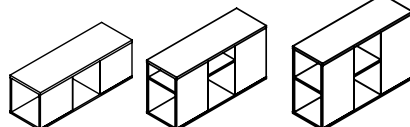
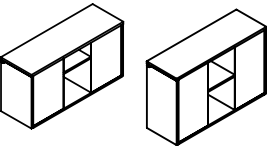
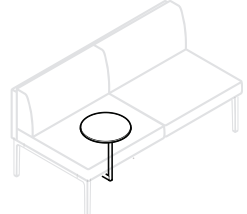
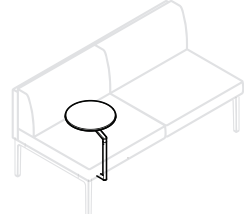
OVERVIEW CASE GOODS	29" Height Only			
Cubby 29", 36", 42" Heights	15" Single 	30" Double 	45" Triple 	60" Quad 
Locker 29", 36", 42" Heights	15" Single 	30" Double 	45" Triple 	60" Quad 
Planter 29", 36", 42" Heights	15" Single 	30" Double 	45" Triple 	60" Quad 
Shelf 29", 36", 42" Heights	30" Double 			
Cubby Combo 29", 36", 42" Heights	45" Triple 			
Locker Combo 29", 36", 42" Heights	45" Triple 			
Tablet Tables	Single Swivel 	Dual Swivel 		

GENERAL INFORMATION

Design

Stylex / Gensler Product Design Consultant

Tables/Case Goods

A selection of wood veneer and laminate are available. Effective 5/15/23, lockers, cubbies and shelves in Grade 1 laminate utilize butt-joint construction. Please see [page 10](#) for details.

Configuration

Free Address is a kit of parts comprised of upholstered seating, case goods, and work surfaces offering integrated solutions at 29" task, 36" counter, and 42" bar heights. The customer has freedom to arrange these components on frames in order to prioritize aesthetics, cost and ease of reconfigurability. Users can address a wide variety of workstyles through configuration: short term, long term, individual or collaborative spaces. To ensure clarity when ordering, it is critical that line items should be listed in the order in which they will be arranged from left end (seated perspective) to right end wherever possible. The use of CET Designer is the preferred method for specifying this product.

Ganging

All frames of the same height may be connected to one another with the use of bent sheet metal ganging brackets.

Tablets

Under mount tablet arms are available in single or dual swivel, with four solid wood finish options. They can be screwed to the underside of Free Address along the front of the unit.

Use

Designed for indoor use only.

Performance Standards

Manufactured to comply with:
 ANSI/BIFMA X5.4 Lounge Seating Tests
 ANSI/BIFMA X5.5 Desk & Table Products
 ANSI/BIFMA X5.9 Storage Units

Certifications

GREENGUARD Gold - Seating, Laminate Table
 GREENGUARD - Case Goods, Privacy Panel, Wood Veneer Table
 LEVEL® 1, BIFMA's sustainability certification program for furniture

Free Address

SPECIFICATION GUIDE: STATEMENT OF LINE, TABLES

OVERVIEW TABLES

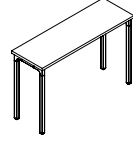
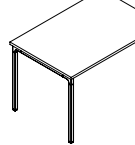
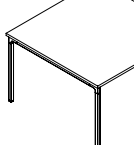
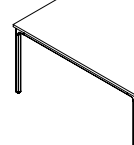
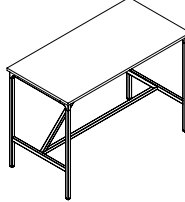
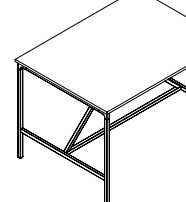
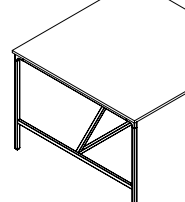
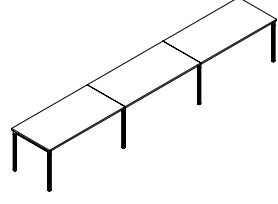
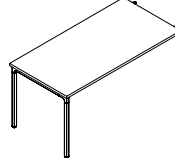
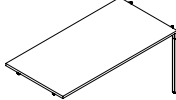
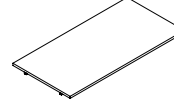
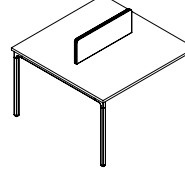
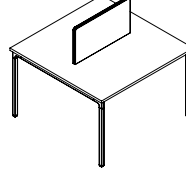
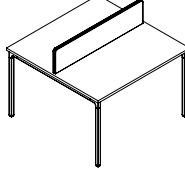
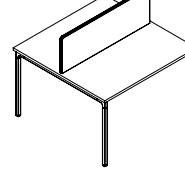
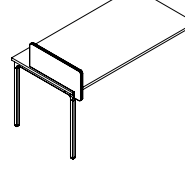
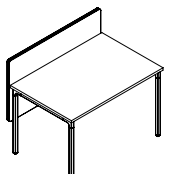
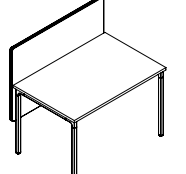
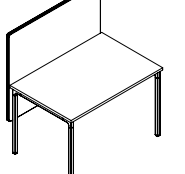
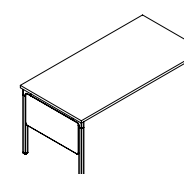
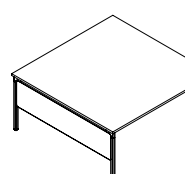
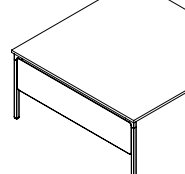
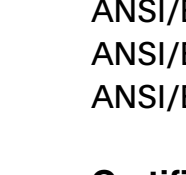
Tables with Frames 29" Desk Height	15D x 30L	30D x 15L	45D x 15L	60D x 15L			
	15D x 45L	30D x 30L	45D x 30L	60D x 30L			
	15D x 60L	30D x 45L	45D x 45L	60D x 45L			
		30D x 60L	45D x 60L	60D x 60L			
							
High Tables with Frames 36" Counter Height 42" Bar Height	30D x 60L	45D x 60L	60D x 60L				
							
Table Runs 29", 36", 42" Heights	Full Assembly	Start Table	Mid Table	End Table			
							
Privacy - Center For 45", 60" Tables	Low 10" - Partial	Mid 15" - Partial	Low 10" - Full	Mid 15" - Full	Privacy - Side	Low 10"	
							
Privacy - Perimeter For 30", 45", 60" Tables	Low 10"	Mid 15"	High 21"	Modesty End	End of 30" Table	End of 45" Table	End of 60" Table
							

GENERAL INFORMATION

Design

Stylex / Gensler Product Design Consultant

Tables/Case Goods

A selection of wood veneer and laminate are available. Lockers, cubbies and shelves in Grade 1 laminate utilize butt-joint construction. Please see [page 10](#) for details.

Screens

Free Address offers privacy and modesty screens which are comprised of a tackable substrate. Contact customer service for upholstery options.

Configuration

Free Address is a kit of parts comprised of upholstered seating, case goods, and work surfaces offering integrated solutions at 29" task, 36" counter, and 42" bar heights. The customer has freedom to arrange these components on frames in order to prioritize aesthetics, cost and ease of reconfigurability. Users can address a wide variety of workstyles through configuration: short term, long term, individual or collaborative spaces. To ensure clarity when ordering, it is critical that line items should be listed in the order in which they will be arranged from left end (seated perspective) to right end wherever possible. The use of CET Designer is the preferred method for specifying this product.

Casters/Glides

Locking casters are available on tables that are larger than 15" in length and depth. Casters come in black, and are available in both hard and soft options. Casters are not available on tables with power. Glide height adjustability of seat height frames is 5/8". Glide height adjustability on tables is 1".

Ganging

All frames of the same height may be connected to one another with the use of bent sheet metal ganging brackets.

Use

Designed for indoor use only.

Performance Standards







Manufactured to comply with:
ANSI/BIFMA X5.4 Lounge Seating Tests
ANSI/BIFMA X5.5 Desk & Table Products
ANSI/BIFMA X5.9 Storage Units

Certifications

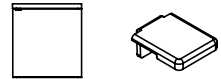
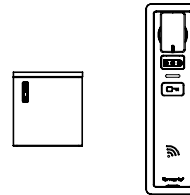
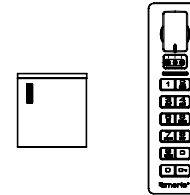
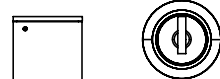
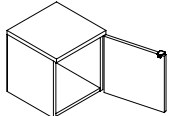
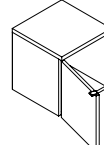
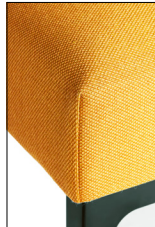
GREENGUARD Gold - Seating, Laminate Table
GREENGUARD - Case Goods, Privacy Panel, Wood Veneer Table
LEVEL® 1, BIFMA's sustainability certification program for furniture

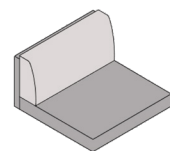
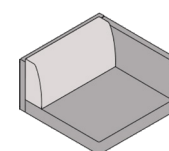
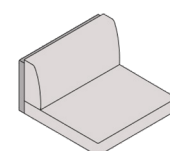
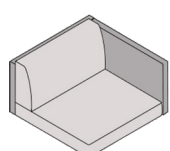
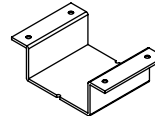
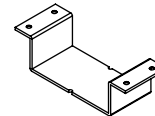
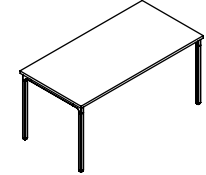
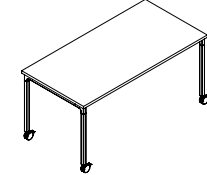
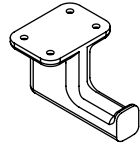
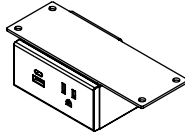
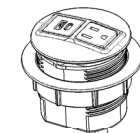
Free Address

SPECIFICATION GUIDE: STATEMENT OF LINE, OPTIONS AND ACCESSORIES

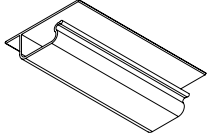
OVERVIEW OPTIONS							
Lock Type	Pull (no lock)	RFID Lock	Number Pad Lock	Key Lock			
							
Locker Hinge Side	Right Hinge (default)	Left Hinge					
							
Upholstery Options Seam Style Dual Fabric	Casual	Pinch	Standard	DF1 for No End Panels	DF1 for End Panels	DF2 for No End Panels	DF2 for End Panels
							
				Fabric 1: Seat Cushion/Back Panel Fabric 2: Back Cushion	Fabric 1: Seat Cushion, Back/Side Panel Fabric 2: Back Cushion	Fabric 1: Back Panel Fabric 2: Seat/Back Cushion	Fabric 1: Back/Side Panel Fabric 2: Seat/Back Cushion
Ganging and Frames	FG1 Seat Height Frames	FG2 Work Height Table Frames		Table Options and Accessories	Glide	Caster (Tables Only)	Bag Hook
							
Power Module	Undermount	Surface Mount	Wireless Charging Pad	Wire Management	Grommet	Wire Snake	Channel
							

GENERAL INFORMATION

Design

Stylex / Gensler Product Design Consultant

Configuration

Free Address is a kit of parts comprised of upholstered seating, case goods, and work surfaces offering integrated solutions at 29" task, 36" counter, and 42" bar heights. The customer has freedom to arrange these components on frames in order to prioritize aesthetics, cost and ease of reconfigurability. Users can address a wide variety of workstyles through configuration: short term, long term, individual or collaborative spaces. To ensure clarity when ordering, it is critical that line items should be listed in the order in which they will be arranged from left end (seated perspective) to right end wherever possible. The use of CET Designer is the preferred method for specifying this product.

Power

Undermount and Surface mount units can be specified to be hardwired or with a 3-prong plug. The units have one USB-A port, one USB-C port, and a standard, grounded 3-prong electrical outlet. Additional power options include daisy chaining and wireless surface mount charging.

Ganging

All frames of the same height may be connected to one another with the use of bent sheet metal ganging brackets.

Use

Designed for indoor use only.

Performance Standards

Manufactured to comply with:
ANSI/BIFMA X5.4 Lounge Seating Tests
ANSI/BIFMA X5.5 Desk & Table Products
ANSI/BIFMA X5.9 Storage Units

Certifications

GREENGUARD Gold - Seating, Laminate Table
GREENGUARD - Case Goods, Privacy Panel, Wood Veneer Table
LEVEL® 1, BIFMA's sustainability certification program for furniture

Free Address

SPECIFICATION GUIDE: GRADE 1 LAMINATE CONSTRUCTION AND CUSTOM FINISH

OVERVIEW OPTIONS

Grade 1 Laminate Construction

Lockers, cubbies and shelves in Grade 1 laminate utilize butt-joint construction. If the backs of any lockers, cubbies, and shelves will be exposed, we recommend utilizing mitered construction by specifying Grade 2 laminate, wood veneer, or a custom solution.

Top View

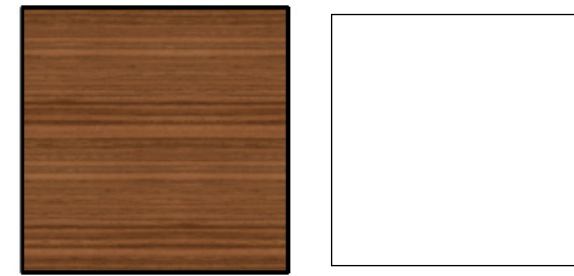

Front View

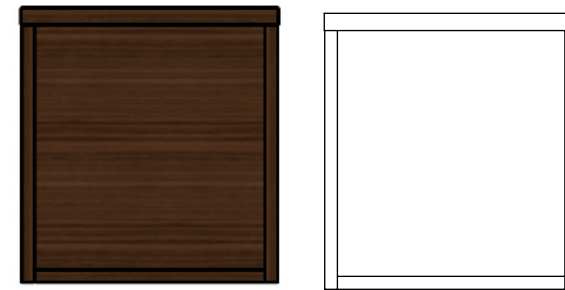

Side View



Rear View

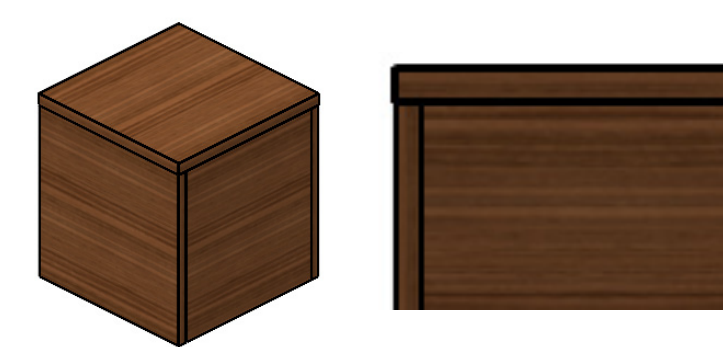
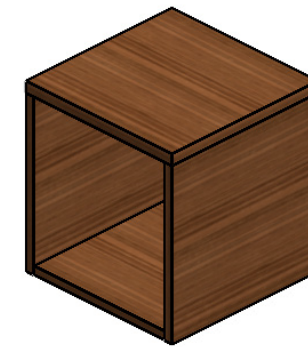

Custom Laminate and Wood Finish

LM99
Custom Laminate

Non-standard laminates will be quoted per color. Please contact Stylex customer service with the manufacturer's name and laminate color reference number.

WV99
Custom Veneer Finish

Two 4"X4" samples are required with, or before, order placement for each custom stain. A custom color match fee of \$554.00 will apply per color. Please contact customer service for details.

GENERAL INFORMATION

Design

Stylex / Gensler Product Design Consultant

Tables/Case Goods

A selection of wood veneer and laminate are available. Lockers, cubbies and shelves in Grade 1 laminate utilize butt-joint construction.

Configuration

Free Address is a kit of parts comprised of upholstered seating, case goods, and work surfaces offering integrated solutions at 29" task, 36" counter, and 42" bar heights. The customer has freedom to arrange these components on frames in order to prioritize aesthetics, cost and ease of reconfigurability. Users can address a wide variety of workstyles through configuration: short term, long term, individual or collaborative spaces. To ensure clarity when ordering, it is critical that line items should be listed in the order in which they will be arranged from left end (seated perspective) to right end wherever possible. The use of CET Designer is the preferred method for specifying this product.

Use

Designed for indoor use only.

Performance Standards

Manufactured to comply with:
ANSI/BIFMA X5.4 Lounge Seating Tests
ANSI/BIFMA X5.5 Desk & Table Products
ANSI/BIFMA X5.9 Storage Units

Certifications



GREENGUARD Gold - Seating, Laminate Table
GREENGUARD - Case Goods, Privacy Panel, Wood Veneer Table
LEVEL® 1, BIFMA's sustainability certification program for furniture

Free Address

SPECIFICATION GUIDE: DIMENSIONS

*Overall height when mounted on a frame.

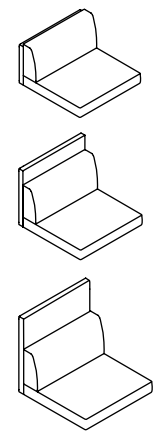
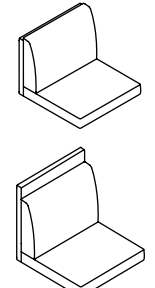
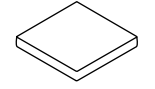
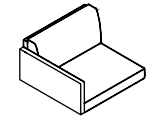
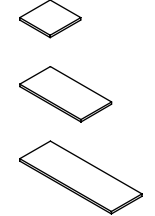
OVERVIEW

Task Seats With or Without End Panels A. Seat Height B. Seat Depth C. Back Height D1. Overall Height (29H) D2. Overall Height (36H) D3. Overall Height (42H) E. Overall Depth F. Overall Length		Single A. 18 B. 20.5 C. 13.5 D1. 30.5 D2. 36.5 D3. 42.5 E. 30 F. 30	Single Plus A. 18 B. 20.5 C. 13.5 D1. 30.5 D2. 36.5 D3. 42.5 E. 30 F. 30	Double A. 18 B. 20.5 C. 13.5 D1. 30.5 D2. 36.5 D3. 42.5 E. 30 F. 30	Triple A. 18 B. 20.5 C. 13.5 D1. 30.5 D2. 36.5 D3. 42.5 E. 30 F. 30	Corner A. 18 B. 20.5 C. 13.5 D1. 30.5 D2. 36.5 D3. 42.5 E. 30 F. 30
Banquette Seats With or Without End Panels A. Seat Height B. Seat Depth C. Back Height D1. Overall Height (36H) D2. Overall Height (42H) E. Overall Depth F. Overall Length		Single A. 18 B. 20.5 C. 20.5 D1. 37.5 D2. 42.5 E. 30 F. 30	Single Plus A. 18 B. 20.5 C. 13.5 D1. 37.5 D2. 42.5 E. 30 F. 30	Double A. 18 B. 20.5 C. 13.5 D1. 37.5 D2. 42.5 E. 30 F. 30	Triple A. 18 B. 20.5 C. 13.5 D1. 37.5 D2. 42.5 E. 30 F. 30	Corner A. 18 B. 20.5 C. 13.5 D1. 37.5 D2. 42.5 E. 30 F. 30
Benches A. Overall Height B. Overall Depth C. Overall Length		Single A. 18 B. 30 C. 30	Single Plus A. 18 B. 30 C. 45	Double A. 18 B. 30 C. 60	Triple A. 18 B. 30 C. 90	Half A. 18 B. 30 C. 15
Arms A. Height B. Depth C. Length		2" Arm A. 26 B. 30 C. 2	4" Arm A. 26 B. 30 C. 4	6" Arm A. 26 B. 30 C. 6		
Seat Height Table Tops All Table Tops are 1" Thick Overall Height on Frame is 14"		15D 15D x 15L 15D x 30L 15D x 45L 15D x 60L 15D x 75L 15D x 90L	30D 30D x 15L 30D x 30L 30D x 45L 30D x 60L	45D 45D x 15L 45D x 30L 45D x 45L 45D x 60L		
Ledge Height Table Tops All Table Tops are 1" Thick		15D 15D x 30L 15D x 60L 15D x 90L				

OVERVIEW

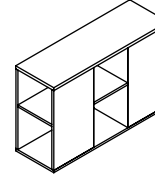
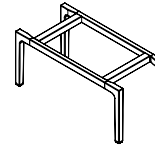
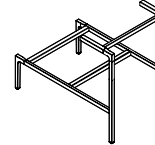
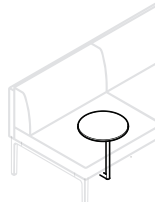
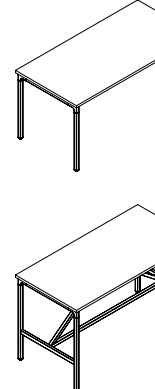
Case Goods A1. Overall Height (29H) A2. Overall Height (36H) A3. Overall Height (42H) B. Overall Depth C. Overall Length		Single A1. 29 A2. 36 A3. 42 B. 15 C. 15	Double A1. 29 A2. 36 A3. 42 B. 15 C. 30	Triple A1. 29 A2. 36 A3. 42 B. 15 C. 45	Quad A1. 29 A2. 36 A3. 42 B. 15 C. 60	Triple Combo A1. 29 A2. 36 A3. 42 B. 15 C. 45
Seat Height Frames All Frames are 13" High Glide Height Adjustability of Seat Height Frames is 5/8"		15D 15D x 15L 15D x 30L 15D x 45L 15D x 60L 15D x 75L 15D x 90L	30D 30D x 15L 30D x 30L 30D x 45L 30D x 60L 30D x 75L 30D x 90L	45D 45D x 15L 45D x 30L 45D x 45L 45D x 60L 45D x 75L 45D x 90L		
Seat with Ledge Frames Height dimension includes tabletop		30L 29H x 30L 36H x 30L 42H x 30L	60L 29H x 60L 36H x 60L 42H x 60L	90L 29H x 90L 36H x 90L 42H x 90L		
Tablet Tables A. Diameter B. Height Above Seat		Single/Dual A. 14 B. 9				
Freestanding Tables Glide Height Adjustability of 29H, 36H and 42H Tables is 1"		Desk 29H 15D x 30L 15D x 45L 15D x 60L 30D x 15L 30D x 30L 30D x 45L 30D x 60L 45D x 15L 45D x 30L 45D x 45L 45D x 60L	Counter 36H 30D x 60L 45D x 60L 60D x 60L	Bar 42H 30D x 60L 45D x 60L 60D x 60L		

Free Address

SPECIFICATION GUIDE: POWER, UNDER MOUNT

UNDER MOUNT POWER OVERVIEW

**Seating,
Under mount Power**
With or Without
End Panels

Position 2 (Right)

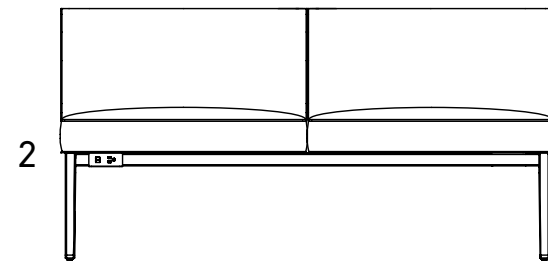

Position 1 and 2 (Left and Right)

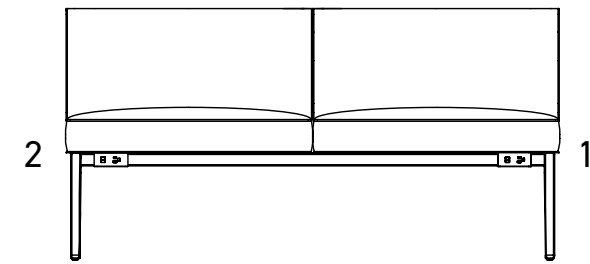

Position 1 (Left)

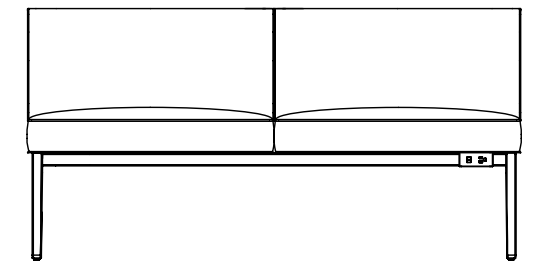

**Ledges,
Under mount Power**

Front View

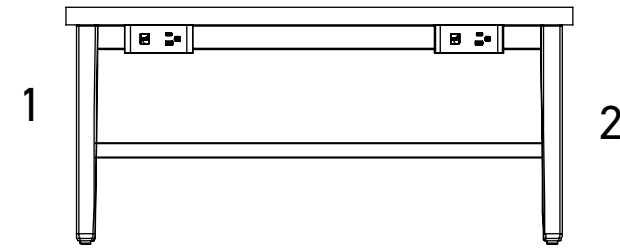

Top View

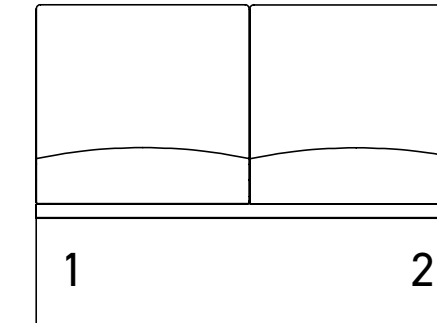

**Tables,
Under mount Power**

Front View

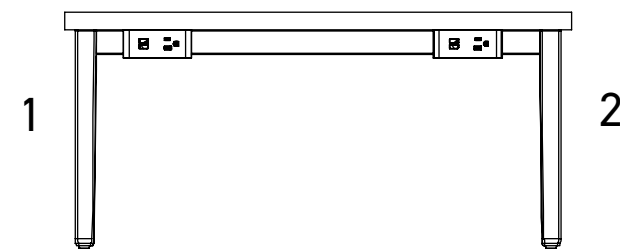

Rear View

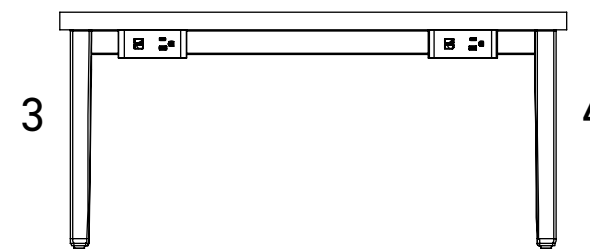

Top View



To Order Select Below

1. Mount Type

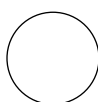

Mount Type

U UNDERMOUNT

2. Color

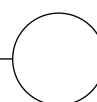

Color

B BLACK

G GRAY

W WHITE

3. Cord

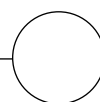

Cord

H HARDWIRE **+193**

4. Location

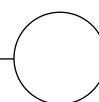

Location

1 POSITION 1 (LEFT) **+623**

2 POSITION 2 (RIGHT) **+623**

GENERAL INFORMATION

Power

Undermount and Surface mount units can be specified to be hardwired or with a 3-prong plug. The units have one USB-A port, one USB-C port, and a standard, grounded 3-prong electrical outlet. Additional power options include daisy chaining and wireless surface mount charging.

Mounting Options

Under mount power is designated by (U) in the model code.

Cord Length

Both the standard cord and the conduit whip are 10 feet long. Other lengths may be available as a custom order.

Colors

Power units are available in black (B), white (W), and gray (G).

Seat Power Location

Power mounted under seat units is located under the front edge on the left side (position 1), right side (position 2), or both (positions 1 & 2) from a seated perspective.

Example:

UB1 - Under mount, black, position 1

Power is not available on corner seats or arms.

Table Location

Power mounted under tables is located under the front and back edges next to each corner (positions 1 through 4) as shown. Ledge tables only have one exposed long edge and therefore have only positions 1 (left) and 2 (right) available.

Example:

UB1 - Under mount, black, position 1

UG13 - Under mount, gray, positions 1 & 3

Free Address

SPECIFICATION GUIDE: POWER, SURFACE MOUNT

SURFACE MOUNT POWER OVERVIEW

Tables, Power Port Location

29H

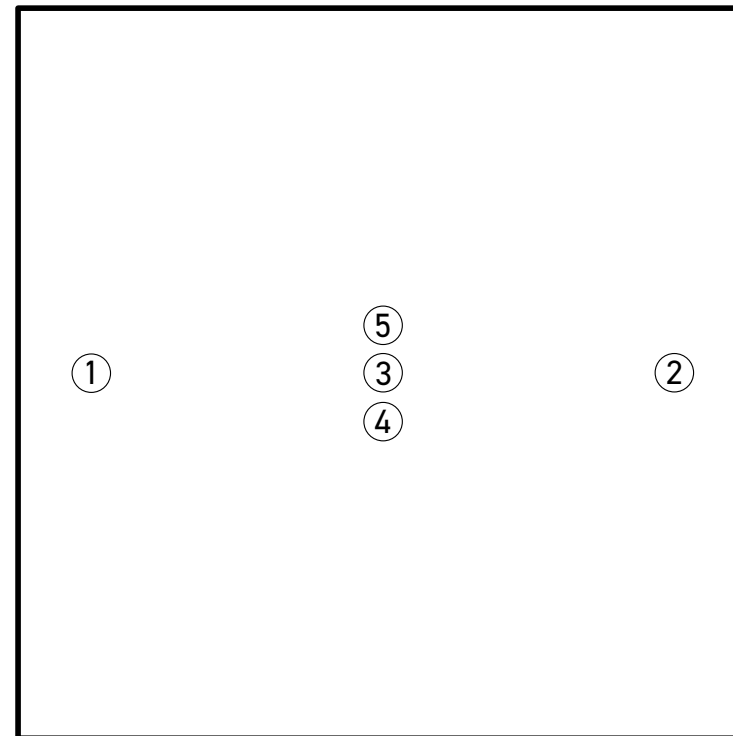

36H and 42H

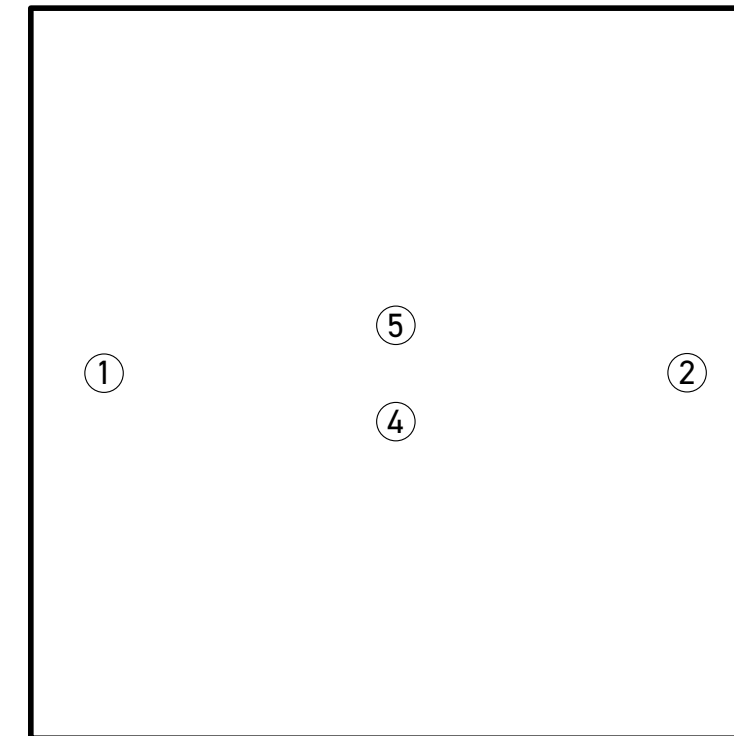

Restrictions

1. Surface power is not available on ledge tops or seat height tops.
2. Position 3 not available when position 4 or 5 is specified.
3. 15" Deep Tables - Surface power not available.
4. 30" Deep Tables - Position 4 and 5 are not available.
5. Full Center Privacy Screen - Positions 1, 2 and 3 are not available.
6. Partial Center Privacy Screen - Position 3 not available.

Cable Management

All units ship with cable mounts and screws included.

GENERAL INFORMATION

Power

Undermount and Surface mount units can be specified to be hardwired or with a 3-prong plug. The units have one USB-A port, one USB-C port, and a standard, grounded 3-prong electrical outlet. Additional power options include daisy chaining and wireless surface mount charging.

Mounting Options

Surface mount power is designated by (S) in the model code.

Cord Length

All power unit cord lengths are 10 feet long. Other lengths may be available as a custom order.

Colors

Power units are available in black (B), white (W), and gray (G).

Location

Surface mount power on tables have 5 possible locations, shown to the left. There are certain location restrictions due to frame and screen configurations.

Example:

SB1 - Surface mount, black, position 1
GTW13 - Grommet, white, positions 1 & 3

To Order Select Below

1. Mount Type

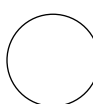

Mount Type

S	SURFACE MOUNT	+551
GT	WIRE GROMMET	+120
WC	WIRELESS CHARGING	+309

2. Color

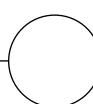

Color

B	BLACK
G	GRAY
W	WHITE

Wireless charging is only available in black.

3. Cord

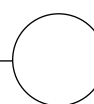

Cord

H	HARDWIRE	+203
---	----------	-------------

Hardwire not available for wireless charging.

4. Location

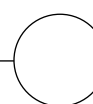

Location

1	POSITION 1 (LEFT)
2	POSITION 2 (RIGHT)
3	POSITION 3 (CENTER)
4	POSITION 4 (CENTER FRONT)
5	POSITION 5 (CENTER BACK)

Free Address

SPECIFICATION GUIDE: POWER, DAISY CHAIN

DAISY CHAIN POWER OVERVIEW

Power Units

Surface Mount

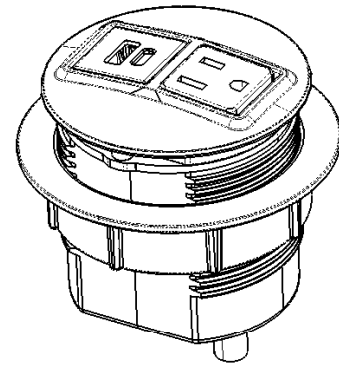

Undermount

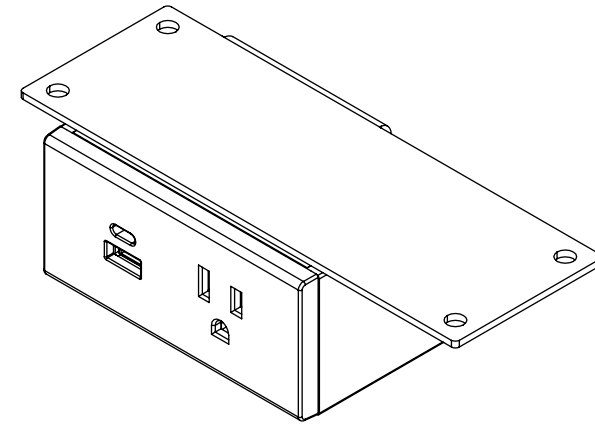

Wireless Charging Pad

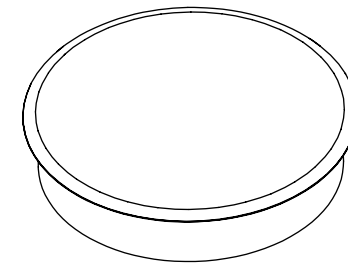

GENERAL INFORMATION

Power

Surface power, undermount power, and wireless charging units can be daisy chained. Up to 8 units can connect to the same system with a single 3-prong plug infeed. Wireless charging pads do not integrate directly into the system and require a Wireless Charging Connector.

Cable Management

All units ship with cable mounts and screws included.

Order Entry

CET is required for order entry. All daisy chain units are entered under 1 line item.

Cable Management

All units ship with cable mounts and screws included.

Use CET to determine jumper lengths and configure daisy chain system.

1. Section

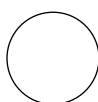

Section

FAPSBS	FREE ADDRESS POWER SYSTEM
--------	---------------------------

2. Options

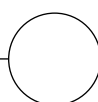

Options

IF	SYSTEM INFEED (REQUIRED) - UNDER MOUNT	+194
IF	SYSTEM INFEED (REQUIRED) - SURFACE MOUNT	+213
SS	SURFACE POWER	+58
U	UNDERMOUNT POWER	+39
WC1	WIRELESS CHARGING CONNECTOR	+216
	JUMPER EXTENSION (5')	+138

Pricing shown above is in addition to the individual power unit charges on the seat/table line item.

Free Address

SPECIFICATION GUIDE: POWER, WIRE MANAGEMENT

WIRE MANAGEMENT OVERVIEW

Wire Management

Wire Snake

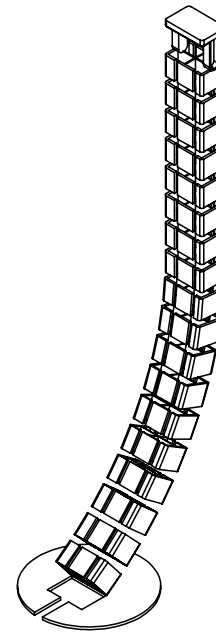

Wire Management Channel

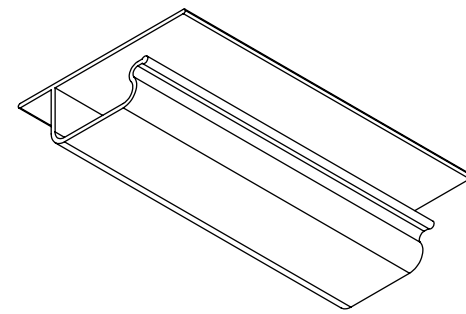

Bag Hook

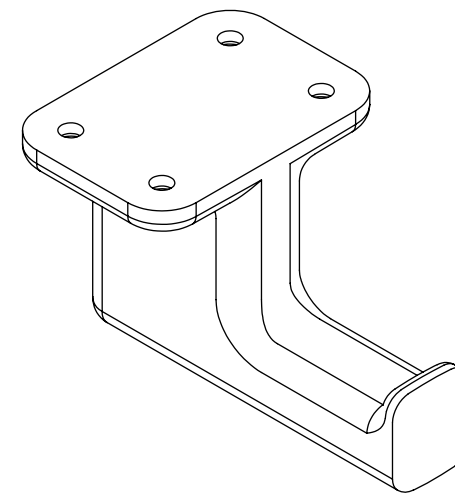

GENERAL INFORMATION

Wire Snake

Flexible vertebrae design with rectangular blocks that snap together, bend and move around. Accommodates 4 different wire channels. A top plate screws to underside of work surface and a heavy steel plate holds the snake in place at the base.

Wire Management Channel

6" long plastic extrusion mounts to underside of units for cable management. Contact Customer Service for more details.

Bag Hook

The bag hook can be powder coated in any of our 26 colors. Weight limit is 35 pounds.

To Order Select Below

1. Section

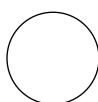

Section

FAW	FREE ADDRESS WIRE MANAGEMENT	
FABK	FREE ADDRESS BAG HOOK	+54

2. Options

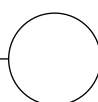

Options

S29	SNAKE, 29"	+504
S36	SNAKE, 36"	+779
S42	SNAKE, 42"	+779
M	CHANNEL (PER SEAT)	+66

Wire snakes are options on work height tables. Wire management channels are options on seating and tables.

Bag hook is its own line item and the others are part for the table line item.

Free Address

SPECIFICATION GUIDE: GANGING AND MASTER KEYS

GANGING AND MASTER KEYS OVERVIEW

Ganging

FAFG1
Seat Height Frame

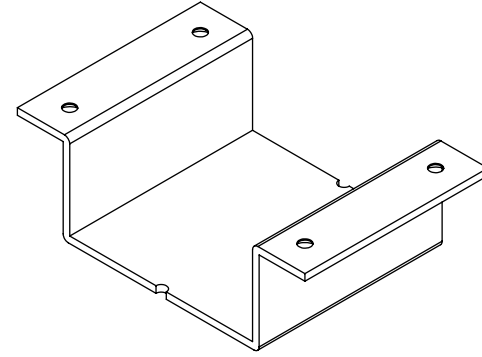

FAFG2
Work Height Table Frame

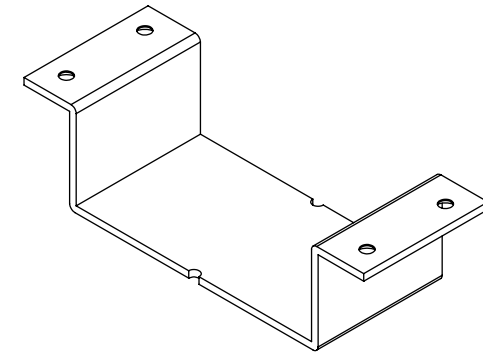

GENERAL INFORMATION

Ganging

Ganging brackets connect frames of identical height. FAFG1 Brackets gang seat height frames together*. FAFG2 Brackets gang work height tables together. Bracket location and quantities must be verified by Stylex or CET Designer.

*Ganging on the ends of 15" deep seat height frames are an exception and require FAFG2 brackets.

Master Key Sets

Each order that contains lockers with locks requires 1 master key set. Additional master keys may be purchased upon request. The RFID and Number pad locks require the digital master key set. The key locks require the key lock master key.

Master Keys

Contact Customer Service for information.

To Order Select Below

1. Section



Section

FAFG1	FREE ADDRESS GANGING BRACKET 1	+57
FAFG2	FREE ADDRESS GANGING BRACKET 2	+57
FADK	FREE ADDRESS DIGITAL MASTER KEY SET	+394
FAMK	FREE ADDRESS KEY LOCK MASTER KEY	+45

Free Address

SPECIFICATION GUIDE: HOW TO ORDER, SEATING

MODEL CODE BREAKDOWN - SEATING

Sample Model Code: FA22SBQE36BDF1UB1COM

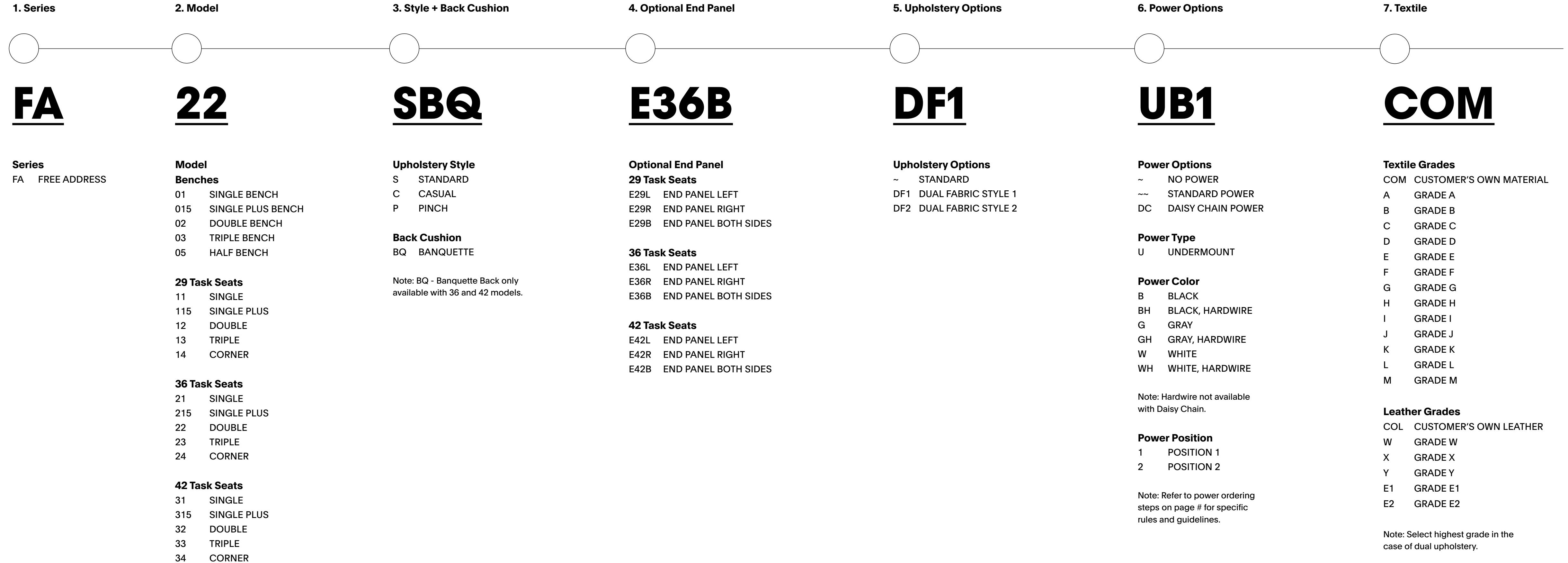

Free Address

SPECIFICATION GUIDE: HOW TO ORDER, CASE GOODS

MODEL CODE BREAKDOWN - CASE GOODS

Sample Model Code: FA6L1H36LM01KBLFB

1. Series	2. Model	3. Height	4. Finish	5. Locker Options	6. Grain Direction	
○	○	○	○	○	○	
<u>FA</u>	<u>6L1</u>	<u>H36</u>	<u>LM01</u>	<u>KBL</u>	<u>FB</u>	
<p>Series FA FREE ADDRESS</p>	<p>Model</p> <p>Locker 6L1 SINGLE 6L2 DOUBLE 6L3 TRIPLE 6L4 QUAD</p> <p>Cubby 6C1 SINGLE 6C2 DOUBLE 6C3 TRIPLE 6C4 QUAD</p> <p>Combo Units 6CX CUBBY COMBO 6LX LOCKER COMBO</p> <p>Planter 6P1 SINGLE 6P2 DOUBLE 6P3 TRIPLE 6P4 QUAD</p> <p>Shelving 6S SHELF</p>	<p>Height H29 29"H H36 36"H H42 42"H</p> <p>Note: Heights limited to specific model sizes.</p>	<p>Finish</p> <p>Laminate Grade 1 LM01 DESIGNER WHITE LM02 ALABASTER LM03 WALLABY LM04 SHADOW LM05 DOVE GRAY LM06 FASHION GRAY LM07 SLATE GRAY LM08 NORTH SEA LM09 BLACK LM10 FUSION MAPLE LM11 MONTICELLO MAPLE LM12 RIVER CHERRY LM13 AMBER CHERRY LM14 WALNUT HEIGHTS LM15 MONTANA WALNUT LM16 XANADU LM17 ASIAN NIGHT</p> <p>Laminate Grade 2 LM41 BIANCO KOS LM42 GRIGIO EFESO LM43 GRIGIO LONDRA LM44 GRIGIO BROMO LM45 NERO INGO</p> <p>Custom Laminate LM99 CUSTOM</p>	<p>Finish</p> <p>Wood Veneer WV01 LIGHT GRAY WV02 WARM GRAY WV03 OPAQUE BLACK WV04 MEDIUM CHERRY WV05 TONED ASH WV06 NATURAL MAPLE WV41 TONED RECON WALNUT WV42 DARK TONED OAK WV43 TONED WENGE WV44 TONED OAK WV45 TONED RECON OAK WV46 NATURAL FLAT CUT WALNUT WV47 NATURAL RIFT CUT WALNUT WV48 NATURAL WHITE OAK WV49 NATURAL RECON WHITE OAK</p> <p>Custom Wood Veneer WV99 CUSTOM</p>	<p>Locker Options</p> <p>Lock Options P DOOR PULL KLB KEY LOCK BLACK KLW KEY LOCK WHITE NPB NUMBER PAD LOCK BLACK NPN NUMBER PAD LOCK NICKEL RFB RFID LOCK BLACK RFN RFID LOCK NICKEL</p> <p>Hinge Side ~ HINGE RIGHT WHEN FACING HG HINGE LEFT WHEN FACING</p>	<p>Grain Direction ~ LEFT/RIGHT FB FRONT/BACK</p>

Free Address

SPECIFICATION GUIDE: HOW TO ORDER, FRAMES

MODEL CODE BREAKDOWN - FRAMES

Sample Model Code: FA8SD30L45CGS1BL

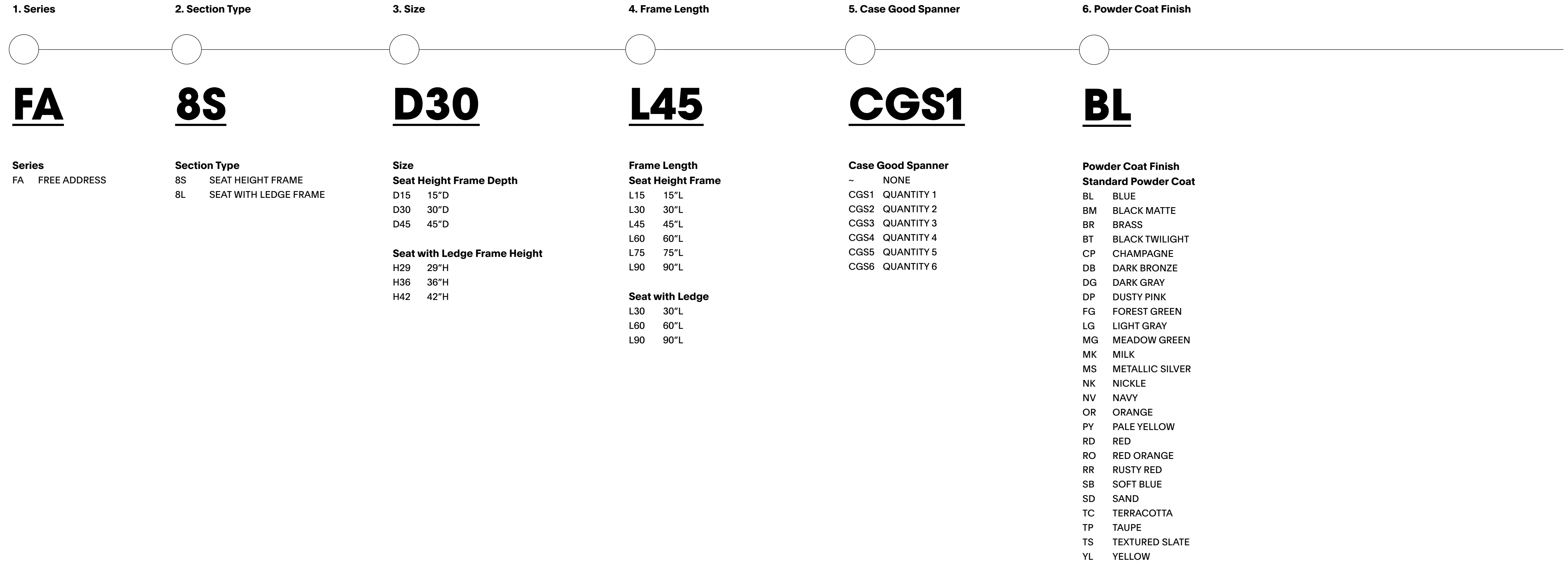

Free Address

BENCHES: TASK BENCH

Textile Upholstery Grades

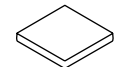
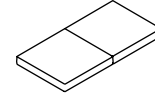
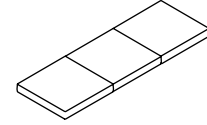
TITLE		SERIES	MODEL	SEAM	PANELS	DIMENSIONS	YDG	COM	A	B	C	D	E	F	G	H	I	J	K	L	M	
Bench, Single		Casual Seam	FA	01	C	-	30W x 30D x 18H	1.7	836	953	1,019	1,080	1,147	1,211	1,281	1,351	1,435	1,542	1,672	1,800	1,929	2,057
		Pinch Seam	FA	01	P	-	30W x 30D x 18H	2.2	860	1,017	1,104	1,188	1,274	1,361	1,454	1,548	1,660	1,802	1,975	2,145	2,318	2,489
		Standard Seam	FA	01	S	-	30W x 30D x 18H	2.2	855	1,012	1,099	1,182	1,269	1,356	1,449	1,544	1,655	1,798	1,970	2,140	2,313	2,483
Bench, Double		Casual Seam	FA	02	C	-	60W x 30D x 18H	3.3	1,458	1,695	1,824	1,950	2,079	2,209	2,350	2,491	2,659	2,872	3,131	3,386	3,645	3,901
		Pinch Seam	FA	02	P	-	60W x 30D x 18H	3.3	1,507	1,744	1,873	1,999	2,128	2,258	2,399	2,540	2,708	2,921	3,179	3,436	3,695	3,950
		Standard Seam	FA	02	S	-	60W x 30D x 18H	3.3	1,497	1,734	1,863	1,989	2,118	2,248	2,390	2,529	2,697	2,911	3,171	3,426	3,684	3,940
Bench, Triple		Casual Seam	FA	03	C	-	90W x 30D x 18H	4.4	2,123	2,437	2,610	2,777	2,951	3,123	3,312	3,500	3,723	4,008	4,352	4,692	5,038	5,378
		Pinch Seam	FA	03	P	-	90W x 30D x 18H	4.4	2,195	2,510	2,682	2,850	3,023	3,195	3,384	3,571	3,796	4,079	4,425	4,765	5,111	5,452
		Standard Seam	FA	03	S	-	90W x 30D x 18H	4.4	2,180	2,495	2,667	2,835	3,007	3,179	3,368	3,556	3,780	4,065	4,410	4,750	5,095	5,437

To Order Select Below

1. Series/Model

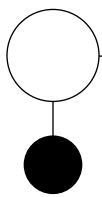

FA01

**Free Address
Bench, Single**

FA02

**Free Address
Bench, Double**

FA03

**Free Address
Bench, Triple**

2. Upholstery Style

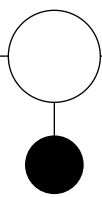

Upholstery Style

C CASUAL

P PINCH

S STANDARD

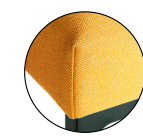

Casual

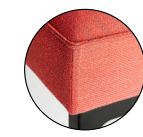

Pinch

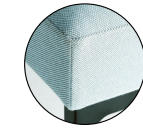

Standard

3. Power

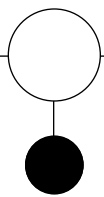

Power

Refer to under mount
power ordering steps
on [page 12](#).

4. Upholstery

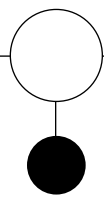

Upholstery

See [general information section](#) for details on textile program and COM/COL information.

Yardages provided are for fabrics cut railroaded. While that is generally our preference for Free Address, there may be exceptions if we decide that up the roll is more visually pleasing. If COM fabrics are to be cut up the roll, please contact customer service. Select highest grade in the case of dual upholstery.

Free Address

BENCHES: TASK BENCH

Textile Upholstery Grades

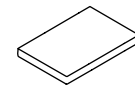
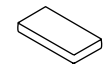
TITLE		SERIES	MODEL	SEAM	PANELS	DIMENSIONS	YDG	COM	A	B	C	D	E	F	G	H	I	J	K	L	M	
Bench, Single Plus		Casual Seam	FA	015	C	-	45W x 30D x 18H	1.9	1,218	1,357	1,431	1,505	1,581	1,656	1,739	1,820	1,917	2,042	2,195	2,343	2,494	2,642
		Pinch Seam	FA	015	P	-	45W x 30D x 18H	2.5	1,321	1,498	1,596	1,689	1,787	1,884	1,989	2,096	2,222	2,381	2,576	2,767	2,961	3,152
		Standard Seam	FA	015	S	-	45W x 30D x 18H	2.5	1,321	1,498	1,596	1,689	1,787	1,884	1,989	2,096	2,222	2,381	2,576	2,767	2,961	3,152
Bench, Half		Casual Seam	FA	05	C	-	15W x 30D x 18H	1.1	586	666	709	751	794	837	884	931	987	1,058	1,145	1,230	1,316	1,401
		Pinch Seam	FA	05	P	-	15W x 30D x 18H	1.1	601	679	722	764	807	851	898	945	1,002	1,072	1,158	1,243	1,330	1,415
		Standard Seam	FA	05	S	-	15W x 30D x 18H	1.1	595	675	718	760	803	846	893	940	995	1,067	1,153	1,238	1,324	1,409

To Order Select Below

1. Series/Model

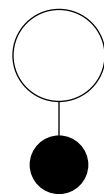

FA015

**Free Address
Bench, Single Plus**

FA05

**Free Address
Bench, Half**

2. Upholstery Style

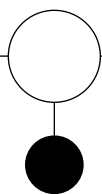

Upholstery Style

C CASUAL

P PINCH

S STANDARD

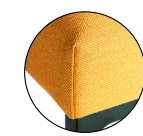

Casual

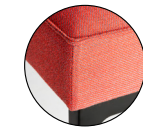

Pinch

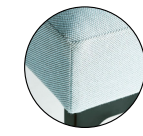

Standard

3. Power

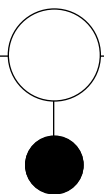

Power

**Refer to under mount
power ordering steps
on page 12.**

4. Upholstery

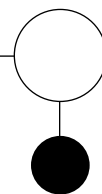

Upholstery

**See general information
section for details on textile
program and COM/COL
information.**

Yardages provided are for fabrics cut railroaded. While that is generally our preference for Free Address, there may be exceptions if we decide that up the roll is more visually pleasing. If COM fabrics are to be cut up the roll, please contact customer service. Select highest grade in the case of dual upholstery.

Free Address

SEATS: 29H TASK

*Height when mounted on a frame.

Textile Upholstery Grades

TITLE		SERIES	MODEL	SEAM	PANELS	DIMENSIONS	YDG	COM	A	B	C	D	E	F	G	H	I	J	K	L	M	
Seat, 29H, Single		Casual Seam	FA	11	C	-	30W x 30D x 30.5H	2.8	1,839	2,036	2,143	2,248	2,355	2,464	2,581	2,699	2,838	3,017	3,232	3,445	3,660	3,873
		Pinch Seam	FA	11	P	-	30W x 30D x 30.5H	2.8	1,872	2,069	2,178	2,282	2,390	2,497	2,615	2,733	2,873	3,050	3,266	3,479	3,695	3,908
		Standard Seam	FA	11	S	-	30W x 30D x 30.5H	2.8	1,867	2,064	2,171	2,277	2,385	2,493	2,610	2,727	2,867	3,045	3,261	3,473	3,690	3,902
Seat, 29H, Single Plus		Casual Seam	FA	115	C	-	45W x 30D x 30.5H	3.3	2,291	2,527	2,657	2,783	2,912	3,042	3,184	3,323	3,491	3,704	3,965	4,220	4,478	4,733
		Pinch Seam	FA	115	P	-	45W x 30D x 30.5H	3.3	2,381	2,618	2,748	2,873	3,003	3,132	3,273	3,415	3,582	3,796	4,054	4,309	4,569	4,824
		Standard Seam	FA	115	S	-	45W x 30D x 30.5H	3	2,381	2,598	2,717	2,832	2,951	3,070	3,199	3,329	3,482	3,677	3,914	4,149	4,386	4,620
Seat, 29H, Double		Casual Seam	FA	12	C	-	60W x 30D x 30.5H	5	3,184	3,537	3,732	3,921	4,114	4,309	4,520	4,732	4,983	5,304	5,692	6,075	6,464	6,846
		Pinch Seam	FA	12	P	-	60W x 30D x 30.5H	5	3,251	3,606	3,800	3,988	4,183	4,377	4,590	4,801	5,052	5,372	5,760	6,143	6,532	6,915
		Standard Seam	FA	12	S	-	60W x 30D x 30.5H	5	3,241	3,596	3,789	3,978	4,173	4,367	4,579	4,790	5,042	5,361	5,751	6,133	6,522	6,905
Seat, 29H, Triple		Casual Seam	FA	13	C	-	90W x 30D x 30.5H	7.2	4,368	4,879	5,161	5,433	5,713	5,994	6,299	6,606	6,969	7,431	7,993	8,545	9,106	9,659
		Pinch Seam	FA	13	P	-	90W x 30D x 30.5H	7.2	4,469	4,981	5,262	5,534	5,815	6,095	6,402	6,706	7,070	7,532	8,093	8,647	9,209	9,762
		Standard Seam	FA	13	S	-	90W x 30D x 30.5H	6.6	4,454	4,927	5,186	5,438	5,696	5,956	6,237	6,519	6,855	7,282	7,799	8,310	8,828	9,339

To Order Select Below

1. Series/Model

FA11	Free Address Seat, 29H, Single
FA115	Free Address Seat, 29H, Single Plus
FA12	Free Address Seat, 29H, Double
FA13	Free Address Seat, 29H, Triple

2. Upholstery Style

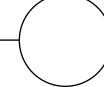
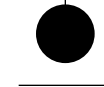
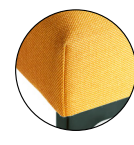
C	CASUAL		Casual
P	PINCH		Pinch
S	STANDARD		Standard

3. Dual Upholstery

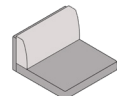
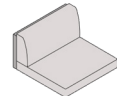
Dual Upholstery	29H Single			29H Single Plus			29H Double			29H Triple		
	C	P	S	C	P	S	C	P	S	C	P	S
DF1  Seat Cushion and Back Panel Back Cushion	2.8 yds	2.2	2.2	3.3	3.0	3.0	3.9	3.3	3.3	6.1	5.0	5.0
	1.1 yds	1.7	1.1	1.7	1.7	1.7	1.7	2.2	1.7	2.8	3.3	2.8
DF2  Back Panel Seat and Back Cushions	1.1 yds	1.1	1.1	1.7	1.7	1.7	1.7	1.7	1.7	2.2	2.2	2.2
	2.8 yds	2.2	2.2	3.3	3.0	3.0	3.9	4.4	3.9	6.1	6.1	5.5

4. Power

Power
Refer to under mount power ordering steps on [page 12](#).

5. Upholstery

Upholstery
See [general information section](#) for details on textile program and COM/COL information.

Yardages provided are for fabrics cut railroaded. While that is generally our preference for Free Address, there may be exceptions if we decide that up the roll is more visually pleasing. If COM fabrics are to be cut up the roll, please contact customer service. Select highest grade in the case of dual upholstery.

Free Address

SEATS: 29H TASK CORNER

*Height when mounted on a frame.

Textile Upholstery Grades

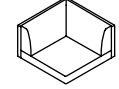
TITLE		SERIES	MODEL	SEAM	PANELS	DIMENSIONS	YDG	COM	A	B	C	D	E	F	G	H	I	J	K	L	M	
Seat, 29H, Corner		Casual Seam	FA	14	C	-	30W x 30D x 30.5H	3.3	2,529	2,766	2,896	3,021	3,151	3,280	3,421	3,563	3,730	3,944	4,202	4,457	4,718	4,973
		Pinch Seam	FA	14	P	-	30W x 30D x 30.5H	3.3	2,577	2,813	2,943	3,068	3,198	3,327	3,469	3,610	3,777	3,991	4,250	4,506	4,764	5,019
		Standard Seam	FA	14	S	-	30W x 30D x 30.5H	3.3	2,575	2,811	2,940	3,066	3,195	3,325	3,465	3,607	3,775	3,988	4,247	4,502	4,762	5,017

To Order Select Below

1. Series/Model

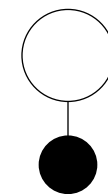

FA14

**Free Address
Seat, 29H, Corner**

2. Upholstery Style

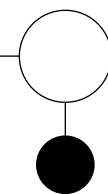

Upholstery Style

C CASUAL

P PINCH

S STANDARD

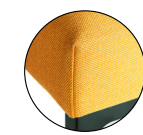

Casual

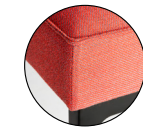

Pinch

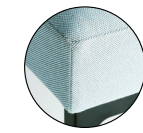

Standard

3. Dual Upholstery

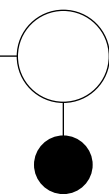

Dual Upholstery

DF1 DUAL UPHOLSTERY STYLE 1

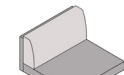
 Seat Cushion and Back Panel
Back Cushion

DF2 DUAL UPHOLSTERY STYLE 2

 Back Panel
Seat and Back Cushions

29H Corner

C P S

2.2 yds 2.2 2.2
1.7 yds 2.2 1.7

C P S

1.7 yds 1.7 1.7
5.0 yds 3.3 2.2

4. Upholstery

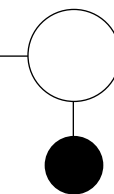

Upholstery

**See general information
section for details on textile
program and COM/COL
information.**



Yardages provided are for fabrics cut
railroaded. While that is generally our
preference for Free Address, there
may be exceptions if we decide that
up the roll is more visually pleasing.
If COM fabrics are to be cut up the
roll, please contact customer service.
Select highest grade in the case of
dual upholstery.

Free Address

SEATS: 29H TASK, END PANEL LEFT/RIGHT

*Height when mounted on a frame.

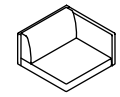
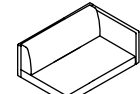
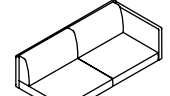
Textile Upholstery Grades

TITLE	SERIES	MODEL	SEAM	PANELS	DIMENSIONS	YDG	COM	A	B	C	D	E	F	G	H	I	J	K	L	M	
Seat, 29H, Single End Panel Left or Right 	Casual Seam	FA	11	C	E29L/R	30W x 30D x 30.5H	3.9	2,213	2,490	2,640	2,788	2,938	3,089	3,254	3,418	3,614	3,862	4,165	4,464	4,765	5,063
	Pinch Seam	FA	11	P	E29L/R	30W x 30D x 30.5H	3.9	2,246	2,522	2,674	2,820	2,972	3,123	3,288	3,452	3,647	3,897	4,198	4,496	4,797	5,097
	Standard Seam	FA	11	S	E29L/R	30W x 30D x 30.5H	3.3	2,243	2,479	2,608	2,734	2,864	2,994	3,134	3,275	3,443	3,656	3,915	4,171	4,431	4,686
Seat, 29H, Single Plus End Panel Left or Right 	Casual Seam	FA	115	C	E29L/R	45W x 30D x 30.5H	4.1	2,764	3,060	3,220	3,378	3,541	3,702	3,879	4,054	4,264	4,531	4,854	5,173	5,498	5,816
	Pinch Seam	FA	115	P	E29L/R	45W x 30D x 30.5H	4.1	2,854	3,149	3,312	3,468	3,630	3,793	3,968	4,144	4,354	4,621	4,944	5,264	5,587	5,907
	Standard Seam	FA	115	S	E29L/R	45W x 30D x 30.5H	3.3	2,854	3,090	3,219	3,345	3,474	3,605	3,745	3,886	4,054	4,267	4,527	4,782	5,041	5,296
Seat, 29H, Double End Panel Left or Right 	Casual Seam	FA	12	C	E29L/R	60W x 30D x 30.5H	6.1	3,558	3,992	4,229	4,460	4,697	4,935	5,193	5,453	5,759	6,151	6,624	7,093	7,568	8,037
	Pinch Seam	FA	12	P	E29L/R	60W x 30D x 30.5H	5.5	3,627	4,020	4,236	4,446	4,661	4,877	5,112	5,347	5,627	5,982	6,413	6,839	7,271	7,697
	Standard Seam	FA	12	S	E29L/R	60W x 30D x 30.5H	5.5	3,616	4,010	4,225	4,435	4,650	4,867	5,102	5,336	5,616	5,971	6,404	6,829	7,261	7,686
Seat, 29H, Triple End Panel Left or Right 	Casual Seam	FA	13	C	E29L/R	90W x 30D x 30.5H	8.3	4,743	5,333	5,656	5,971	6,295	6,619	6,972	7,324	7,743	8,276	8,925	9,562	10,210	10,848
	Pinch Seam	FA	13	P	E29L/R	90W x 30D x 30.5H	7.7	4,845	5,396	5,697	5,991	6,294	6,595	6,924	7,253	7,644	8,142	8,747	9,343	9,948	10,543
	Standard Seam	FA	13	S	E29L/R	90W x 30D x 30.5H	7.7	4,830	5,381	5,684	5,978	6,279	6,581	6,911	7,240	7,630	8,128	8,733	9,328	9,934	10,529

To Order Select Below

1. Series/Model

FA11	Free Address Seat, 29H, Single
FA115	Free Address Seat, 29H, Single Plus
FA12	Free Address Seat, 29H, Double
FA13	Free Address Seat, 29H, Triple

2. Upholstery Style

C	CASUAL
P	PINCH
S	STANDARD



Casual

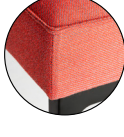

Pinch

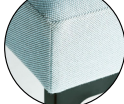

Standard

3. End Panel

E29L	29H END PANEL LEFT
E29R	29H END PANEL RIGHT

4. Dual Upholstery

Dual Upholstery	29H Single			29H Single Plus			29H Double			29H Triple		
	C	P	S	C	P	S	C	P	S	C	P	S
DF1 Seat Cushion, Back Panel, and End Panel Back Cushion	3.3 yds	3.3	3.3	3.3	3.3	3.0	5.0	4.4	4.4	7.2	6.1	6.1
	1.1 yds	1.1	1.1	1.4	1.7	1.7	1.7	2.2	1.7	2.8	3.3	2.8
DF2 Back Panel and End Panel Seat and Back Cushions	2.2 yds	2.2	2.2	2.2	2.2	1.9	2.2	2.2	3.9	3.3	3.3	3.3
	2.8 yds	2.2	2.2	3.3	2.8	1.9	3.9	4.4	2.2	6.1	6.1	5.5

5. Power

Power
Refer to under mount power ordering steps on page 12.

6. Upholstery

Upholstery
See general information section for details on textile program and COM/ COL information.

Yardages provided are for fabrics cut railroaded. While that is generally our preference for Free Address, there may be exceptions if we decide that up the roll is more visually pleasing. If COM fabrics are to be cut up the roll, please contact customer service. Select highest grade in the case of dual upholstery.

Free Address

SEATS: 29H TASK, END PANEL BOTH

*Height when mounted on a frame.

Textile Upholstery Grades

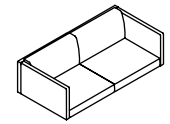
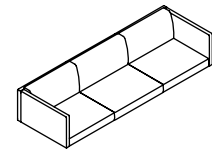
TITLE		SERIES	MODEL	SEAM	PANELS	DIMENSIONS	YDG	COM	A	B	C	D	E	F	G	H	I	J	K	L	M	
Seat, 29H, Double End Panel Both		Casual Seam	FA	12	C	E29B	60W x 30D x 30.5H	6.6	3,934	4,406	4,665	4,917	5,175	5,434	5,716	5,999	6,334	6,761	7,280	7,790	8,308	8,818
		Pinch Seam	FA	12	P	E29B	60W x 30D x 30.5H	6.6	4,001	4,474	4,732	4,984	5,243	5,502	5,783	6,066	6,402	6,828	7,346	7,856	8,375	8,886
		Standard Seam	FA	12	S	E29B	60W x 30D x 30.5H	6.6	3,992	4,465	4,723	4,975	5,234	5,494	5,775	6,056	6,392	6,819	7,337	7,848	8,365	8,877
Seat, 29H, Triple End Panel Both		Casual Seam	FA	13	C	E29B	90W x 30D x 30.5H	8.8	5,119	5,749	6,094	6,429	6,775	7,120	7,496	7,872	8,319	8,888	9,579	10,260	10,952	11,632
		Pinch Seam	FA	13	P	E29B	90W x 30D x 30.5H	8.8	5,220	5,851	6,195	6,531	6,876	7,221	7,598	7,973	8,421	8,989	9,681	10,361	11,052	11,734
		Standard Seam	FA	13	S	E29B	90W x 30D x 30.5H	8.3	5,205	5,796	6,119	6,433	6,758	7,082	7,433	7,786	8,206	8,738	9,386	10,024	10,672	11,311

To Order Select Below

1. Series/Model

FA12
Free Address Seat, 29H, Double

FA13
Free Address Seat, 29H, Triple

2. Upholstery Style

Upholstery Style

C CASUAL

P PINCH

S STANDARD

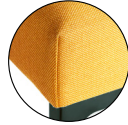
 **Casual**

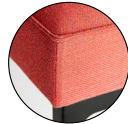
 **Pinch**

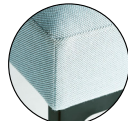
 **Standard**

3. End Panel

End Panel

E29B 29H END PANEL BOTH

4. Dual Upholstery

Dual Upholstery

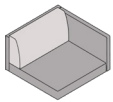
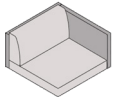
	Dual Upholstery	29H Double			29H Triple		
		C	P	S	C	P	S
	Seat Cushion, Back Panel, and End Panels Back Cushion	6.1 yds	5.0	5.0	7.7	6.1	6.1
		1.7 yds	2.2	1.7	2.8	3.3	2.8
<hr/>	<hr/>	<hr/>	<hr/>	<hr/>	<hr/>	<hr/>	<hr/>
	DF2 DUAL UPHOLSTERY STYLE 2	C	P	S	C	P	S
	Back Panel and End Panels Seat and Back Cushions	3.3 yds	3.3	3.3	3.9	3.9	3.9
		3.3 yds	4.4	3.9	6.1	6.1	5.5

5. Power

Power

Refer to under mount power ordering steps on page 12.

6. Upholstery

Upholstery

See general information section for details on textile program and COM/COL information.

Yardages provided are for fabrics cut railroaded. While that is generally our preference for Free Address, there may be exceptions if we decide that up the roll is more visually pleasing. If COM fabrics are to be cut up the roll, please contact customer service. Select highest grade in the case of dual upholstery.

Free Address

SEATS: 36H TASK



*Height when mounted on a frame.

Textile Upholstery Grades



TITLE		SERIES	MODEL	SEAM	PANELS	DIMENSIONS	YDG	COM	A	B	C	D	E	F	G	H	I	J	K	L	M	
Seat, 36H, Single		Casual Seam	FA	21	C	-	30W x 30D x 36.5H	3.6	2,073	2,329	2,469	2,605	2,746	2,886	3,039	3,191	3,373	3,604	3,885	4,162	4,442	4,719
		Pinch Seam	FA	21	P	-	30W x 30D x 36.5H	3	2,144	2,361	2,479	2,595	2,713	2,832	2,961	3,090	3,245	3,440	3,677	3,911	4,149	4,383
		Standard Seam	FA	21	S	-	30W x 30D x 36.5H	3	2,144	2,361	2,479	2,595	2,713	2,832	2,961	3,090	3,245	3,440	3,677	3,911	4,149	4,383
Seat, 36H, Single Plus		Casual Seam	FA	215	C	-	45W x 30D x 36.5H	5	2,468	2,822	3,017	3,205	3,400	3,594	3,805	4,016	4,268	4,589	4,977	5,359	5,749	6,132
		Pinch Seam	FA	215	P	-	45W x 30D x 36.5H	4.4	2,558	2,873	3,046	3,214	3,386	3,558	3,746	3,935	4,158	4,443	4,788	5,129	5,474	5,814
		Standard Seam	FA	215	S	-	45W x 30D x 36.5H	4.4	2,558	2,873	3,046	3,214	3,386	3,558	3,746	3,935	4,158	4,443	4,788	5,129	5,474	5,814
Seat, 36H, Double		Casual Seam	FA	22	C	-	60W x 30D x 36.5H	6.1	3,383	3,815	4,053	4,283	4,521	4,759	5,017	5,275	5,583	5,973	6,449	6,917	7,391	7,859
		Pinch Seam	FA	22	P	-	60W x 30D x 36.5H	5.8	3,525	3,939	4,164	4,385	4,611	4,837	5,085	5,331	5,625	5,998	6,451	6,899	7,352	7,798
		Standard Seam	FA	22	S	-	60W x 30D x 36.5H	5.2	3,525	3,899	4,104	4,303	4,508	4,712	4,936	5,160	5,425	5,763	6,172	6,577	6,988	7,391
Seat, 36H, Triple		Casual Seam	FA	23	C	-	90W x 30D x 36.5H	9.1	4,944	5,594	5,950	6,296	6,652	7,008	7,396	7,784	8,246	8,832	9,545	10,247	10,959	11,661
		Pinch Seam	FA	23	P	-	90W x 30D x 36.5H	8.8	5,159	5,789	6,135	6,469	6,816	7,161	7,537	7,913	8,360	8,929	9,620	10,301	10,990	11,672
		Standard Seam	FA	23	S	-	90W x 30D x 36.5H	7.7	5,159	5,711	6,012	6,306	6,608	6,911	7,240	7,568	7,960	8,458	9,062	9,657	10,263	10,858

To Order Select Below



1. Series/Model

	
FA21	Free Address Seat, 36H, Single
FA215	Free Address Seat, 36H, Single Plus
FA22	Free Address Seat, 36H, Double
FA23	Free Address Seat, 36H, Triple

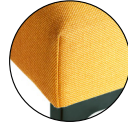
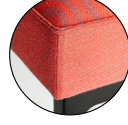
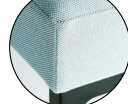

2. Upholstery Style

		Upholstery Style
C	CASUAL	
P	PINCH	
S	STANDARD	

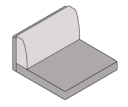
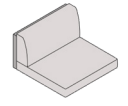

3. Dual Upholstery

		Dual Upholstery	36H Single	36H Single Plus	36H Double	36H Triple
DF1	DUAL UPHOLSTERY STYLE 1		C P S	C P S	C P S	C P S
	Seat Cushion and Back Panel Back Cushion		3.6 yds 3.0 3.0 1.1 yds 1.1 1.1	5.0 4.4 4.4 1.7 1.7 1.7	5.0 4.4 4.4 1.7 2.2 1.7	7.4 6.3 6.3 2.5 3.0 2.2
DF2	DUAL UPHOLSTERY STYLE 2		C P S	C P S	C P S	C P S
	Back Panel Seat and Back Cushions		2.2 yds 2.2 2.2 2.5 yds 2.2 2.2	3.0 3.0 3.0 3.3 3.0 3.0	2.5 2.5 2.5 3.9 3.9 3.6	3.3 3.3 3.3 6.1 5.8 5.2

4. Power

		Power
		Refer to under mount power ordering steps on page 12.

5. Upholstery

		Upholstery
		See general information section for details on textile program and COM/COL information.
		Yardages provided are for fabrics cut railroaded. While that is generally our preference for Free Address, there may be exceptions if we decide that up the roll is more visually pleasing. If COM fabrics are to be cut up the roll, please contact customer service. Select highest grade in the case of dual upholstery.

Free Address

SEATS: 36H TASK CORNER

*Height when mounted on a frame.

Textile Upholstery Grades

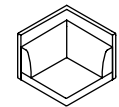
TITLE		SERIES	MODEL	SEAM	PANELS	DIMENSIONS	YDG	COM	A	B	C	D	E	F	G	H	I	J	K	L	M	
Seat, 36H, Corner		Casual Seam	FA	24	C	-	30W x 30D x 36.5H	4.1	3,038	3,333	3,495	3,653	3,815	3,975	4,153	4,328	4,538	4,805	5,129	5,447	5,772	6,091
		Pinch Seam	FA	24	P	-	30W x 30D x 36.5H	4.7	3,084	3,418	3,602	3,780	3,964	4,148	4,347	4,547	4,785	5,086	5,454	5,815	6,182	6,545
		Standard Seam	FA	24	S	-	30W x 30D x 36.5H	4.1	3,084	3,379	3,542	3,698	3,860	4,023	4,198	4,375	4,583	4,851	5,174	5,495	5,817	6,137

To Order Select Below

1. Series/Model

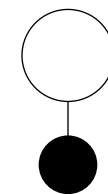

FA24

**Free Address
Seat, 36H, Corner**

2. Upholstery Style

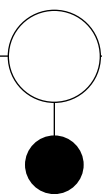

Upholstery Style

- C CASUAL
- P PINCH
- S STANDARD

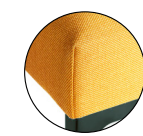

Casual

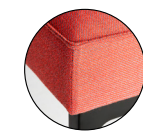

Pinch

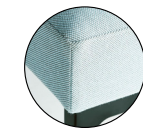

Standard

3. Dual Upholstery

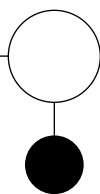

Dual Upholstery

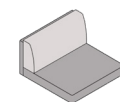
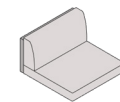
		36H Corner		
DF1	DUAL UPHOLSTERY STYLE 1	C	P	S
	Seat Cushion and Back Panel	3.3 yds	3.0	3.0
	Back Cushion	1.4 yds	1.7	1.4
DF2	DUAL UPHOLSTERY STYLE 2	C	P	S
	Back Panel	2.2 yds	2.2	2.2
	Seat and Back Cushions	2.2 yds	2.5	2.2

4. Upholstery

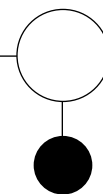

Upholstery

See general information section for details on textile program and COM/COL information.

Yardages provided are for fabrics cut railroaded. While that is generally our preference for Free Address, there may be exceptions if we decide that up the roll is more visually pleasing. If COM fabrics are to be cut up the roll, please contact customer service. Select highest grade in the case of dual upholstery.

Free Address

SEATS: 36H TASK, END PANEL LEFT/RIGHT

*Height when mounted on a frame.

Textile Upholstery Grades

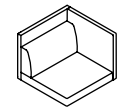
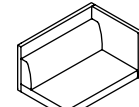
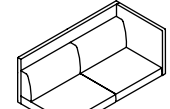
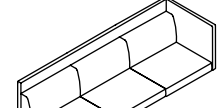
TITLE	SERIES	MODEL	SEAM	PANELS	DIMENSIONS	YDG	COM	A	B	C	D	E	F	G	H	I	J	K	L	M	
Seat, 36H, Single End Panel Left or Right 	Casual Seam	FA	21	C	E36L/R	30W x 30D x 36.5H	4.4	2,654	2,970	3,143	3,311	3,483	3,655	3,843	4,031	4,255	4,539	4,886	5,226	5,570	5,910
	Pinch Seam	FA	21	P	E36L/R	30W x 30D x 36.5H	3.9	2,765	3,040	3,192	3,339	3,489	3,640	3,805	3,970	4,165	4,414	4,717	5,015	5,316	5,614
	Standard Seam	FA	21	S	E36L/R	30W x 30D x 36.5H	4.1	2,765	3,061	3,221	3,379	3,542	3,703	3,880	4,055	4,265	4,532	4,856	5,174	5,499	5,817
Seat, 36H, Single Plus End Panel Left or Right 	Casual Seam	FA	215	C	E36L/R	45W x 30D x 36.5H	5.8	3,116	3,530	3,757	3,977	4,204	4,431	4,677	4,923	5,217	5,590	6,044	6,491	6,945	7,391
	Pinch Seam	FA	215	P	E36L/R	45W x 30D x 36.5H	5.5	3,207	3,600	3,817	4,026	4,242	4,457	4,692	4,929	5,207	5,563	5,994	6,421	6,851	7,278
	Standard Seam	FA	215	S	E36L/R	45W x 30D x 36.5H	5.5	3,207	3,600	3,817	4,026	4,242	4,457	4,692	4,929	5,207	5,563	5,994	6,421	6,851	7,278
Seat, 36H, Double End Panel Left or Right 	Casual Seam	FA	22	C	E36L/R	60W x 30D x 36.5H	6.9	3,971	4,464	4,733	4,995	5,265	5,535	5,829	6,123	6,472	6,916	7,456	7,988	8,528	9,059
	Pinch Seam	FA	22	P	E36L/R	60W x 30D x 36.5H	6.3	4,115	4,568	4,816	5,058	5,306	5,553	5,824	6,094	6,416	6,824	7,321	7,810	8,307	8,797
	Standard Seam	FA	22	S	E36L/R	60W x 30D x 36.5H	6.3	4,115	4,568	4,816	5,058	5,306	5,553	5,824	6,094	6,416	6,824	7,321	7,810	8,307	8,797
Seat, 36H, Triple End Panel Left or Right 	Casual Seam	FA	23	C	E36L/R	90W x 30D x 36.5H	9.9	5,490	6,199	6,588	6,965	7,354	7,743	8,165	8,588	9,091	9,730	10,508	11,274	12,052	12,817
	Pinch Seam	FA	23	P	E36L/R	90W x 30D x 36.5H	8.8	5,704	6,334	6,679	7,015	7,359	7,706	8,082	8,458	8,904	9,473	10,164	10,845	11,536	12,217
	Standard Seam	FA	23	S	E36L/R	90W x 30D x 36.5H	8.8	5,704	6,334	6,679	7,015	7,359	7,706	8,082	8,458	8,904	9,473	10,164	10,845	11,536	12,217

To Order Select Below

1. Series/Model

FA21	Free Address Seat, 36H, Single
FA215	Free Address Seat, 36H, Single Plus
FA22	Free Address Seat, 36H, Double
FA23	Free Address Seat, 36H, Triple

2. Upholstery Style

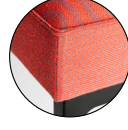
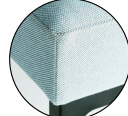
Upholstery Style
C CASUAL
P PINCH
S STANDARD
 Casual
 Pinch
 Standard

3. End Panel

End Panel
E36L 36H END PANEL LEFT
E36R 36H END PANEL RIGHT

4. Dual Upholstery

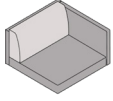
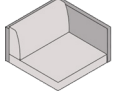
Dual Upholstery	36H Single			36H Single Plus			36H Double			36H Triple		
DF1 DUAL UPHOLSTERY STYLE 1	C	P	S	C	P	S	C	P	S	C	P	S
 Seat Cushion, Back Panel, and End Panel Back Cushion	4.1 yds	3.9	3.9	5.2	4.7	4.7	6.1	5.2	5.2	8.3	7.2	7.2
	1.1 yds	1.1	1.1	1.4	1.7	1.4	1.7	1.9	1.7	2.2	3.0	2.2
DF2 DUAL UPHOLSTERY STYLE 2	C	P	S	C	P	S	C	P	S	C	P	S
 Back Panel and End Panel Seat and Back Cushions	3.0 yds	3.0	3.0	3.3	3.3	3.3	3.3	3.3	3.3	4.4	4.4	4.4
	2.2 yds	1.9	1.9	3.9	2.8	2.8	3.9	3.9	3.3	6.1	5.0	5.2

5. Power

Power
Refer to under mount power ordering steps on page 12.

6. Upholstery

Upholstery
See general information section for details on textile program and COM/ COL information.

Yardages provided are for fabrics cut railroaded. While that is generally our preference for Free Address, there may be exceptions if we decide that up the roll is more visually pleasing. If COM fabrics are to be cut up the roll, please contact customer service. Select highest grade in the case of dual upholstery.

Free Address

SEATS: 36H TASK, END PANEL BOTH

*Height when mounted on a frame.

Textile Upholstery Grades

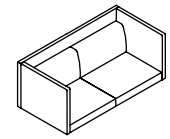
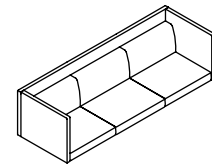
TITLE		SERIES	MODEL	SEAM	PANELS	DIMENSIONS	YDG	COM	A	B	C	D	E	F	G	H	I	J	K	L	M	
Seat, 36H, Double End Panel Both		Casual Seam	FA	22	C	E36B	60W x 30D x 36.5H	7.7	4,673	5,225	5,526	5,820	6,122	6,424	6,753	7,082	7,473	7,971	8,575	9,172	9,777	10,372
		Pinch Seam	FA	22	P	E36B	60W x 30D x 36.5H	7.2	4,815	5,327	5,608	5,880	6,161	6,441	6,746	7,053	7,415	7,878	8,439	8,992	9,554	10,106
		Standard Seam	FA	22	S	E36B	60W x 30D x 36.5H	7.2	4,815	5,327	5,608	5,880	6,161	6,441	6,746	7,053	7,415	7,878	8,439	8,992	9,554	10,106
Seat, 36H, Triple End Panel Both		Casual Seam	FA	23	C	E36B	90W x 30D x 36.5H	10.7	6,022	6,789	7,210	7,620	8,040	8,461	8,919	9,378	9,923	10,616	11,458	12,287	13,129	13,960
		Pinch Seam	FA	23	P	E36B	90W x 30D x 36.5H	9.6	6,236	6,926	7,303	7,669	8,048	8,425	8,836	9,247	9,737	10,359	11,114	11,860	12,615	13,359
		Standard Seam	FA	23	S	E36B	90W x 30D x 36.5H	9.9	6,236	6,945	7,333	7,711	8,099	8,488	8,911	9,333	9,836	10,477	11,254	12,020	12,797	13,563

To Order Select Below

1. Series/Model

FA22
Free Address Seat, 36H, Double

FA23
Free Address Seat, 36H, Triple

2. Upholstery Style

Upholstery Style

C CASUAL

P PINCH

S STANDARD

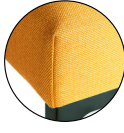
 **Casual**

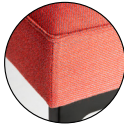
 **Pinch**

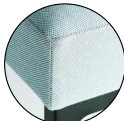
 **Standard**

3. End Panel

End Panel

E36B 36H END PANEL BOTH

4. Dual Upholstery

Dual Upholstery

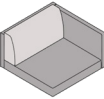
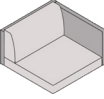
	Dual Upholstery	36H Double			36H Triple		
		C	P	S	C	P	S
	DF1 DUAL UPHOLSTERY STYLE 1 Seat Cushion, Back Panel, and End Panels Back Cushion	6.9 yds	6.1	6.3	9.1	8.0	8.3
		1.4 yds	1.9	1.4	2.2	3.0	2.2
	DF2 DUAL UPHOLSTERY STYLE 2 Back Panel and End Panels Seat and Back Cushions	4.4 yds	4.4	4.4	5.2	5.2	5.2
		3.6 yds	3.9	3.3	5.8	5.8	5.0

5. Power

Power

Refer to under mount power ordering steps on [page 12](#).

6. Upholstery

Upholstery

See [general information section](#) for details on textile program and COM/COL information.

Yardages provided are for fabrics cut railroaded. While that is generally our preference for Free Address, there may be exceptions if we decide that up the roll is more visually pleasing. If COM fabrics are to be cut up the roll, please contact customer service. Select highest grade in the case of dual upholstery.

Free Address

SEATS: 36H BANQUETTE

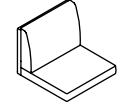
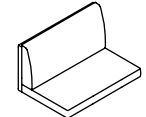
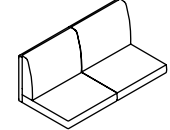
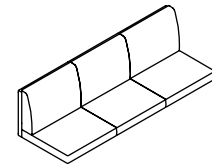

*Height when mounted on a frame.

Textile Upholstery Grades





TITLE		SERIES	MODEL	SEAM	PANELS	DIMENSIONS	YDG	COM	A	B	C	D	E	F	G	H	I	J	K	L	M
 Seat, 36H Banquette, Single	Casual Seam	FA	21	C	BQ	30W x 30D x 37.5H	4.4	2,295	2,610	2,783	2,951	3,123	3,295	3,484	3,672	3,896	4,180	4,526	4,866	5,211	5,552
	Pinch Seam	FA	21	P	BQ	30W x 30D x 37.5H	4.1	2,144	2,361	2,479	2,595	2,713	2,832	2,961	3,090	3,245	3,440	3,677	3,911	4,149	4,383
	Standard Seam	FA	21	S	BQ	30W x 30D x 37.5H	4.1	2,144	2,361	2,479	2,595	2,712	2,833	2,962	3,090	3,243	3,440	3,676	3,912	4,150	4,383
 Seat, 36H Banquette, Single Plus	Casual Seam	FA	215	C	BQ	45W x 30D x 37.5H	6.3	2,742	3,194	3,443	3,684	3,932	4,181	4,451	4,721	5,043	5,452	5,948	6,438	6,934	7,424
	Pinch Seam	FA	215	P	BQ	45W x 30D x 37.5H	5.8	2,835	3,248	3,474	3,695	3,922	4,149	4,395	4,641	4,935	5,308	5,761	6,209	6,662	7,110
	Standard Seam	FA	215	S	BQ	45W x 30D x 37.5H	5.8	2,835	3,248	3,474	3,695	3,922	4,149	4,395	4,641	4,935	5,308	5,761	6,209	6,662	7,110
 Seat, 36H Banquette, Double	Casual Seam	FA	22	C	BQ	60W x 30D x 37.5H	6.9	3,799	4,291	4,561	4,823	5,093	5,362	5,656	5,950	6,299	6,744	7,284	7,815	8,355	8,887
	Pinch Seam	FA	22	P	BQ	60W x 30D x 37.5H	6.3	3,945	4,397	4,646	4,887	5,135	5,383	5,654	5,924	6,245	6,654	7,151	7,640	8,136	8,627
	Standard Seam	FA	22	S	BQ	60W x 30D x 37.5H	6.3	3,945	4,397	4,646	4,887	5,135	5,383	5,654	5,924	6,245	6,654	7,151	7,640	8,136	8,627
 Seat, 36H Banquette, Triple	Casual Seam	FA	23	C	BQ	90W x 30D x 37.5H	10.2	5,510	6,238	6,637	7,026	7,425	7,824	8,259	8,693	9,211	9,868	10,668	11,454	12,252	13,040
	Pinch Seam	FA	23	P	BQ	90W x 30D x 37.5H	9.1	5,729	6,379	6,735	7,081	7,437	7,794	8,181	8,568	9,030	9,616	10,330	11,031	11,743	12,446
	Standard Seam	FA	23	S	BQ	90W x 30D x 37.5H	9.1	5,729	6,379	6,735	7,081	7,437	7,794	8,181	8,568	9,030	9,616	10,330	11,031	11,743	12,446

To Order Select Below

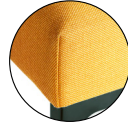
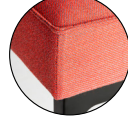
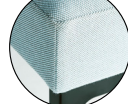

1. Series/Model

	
FA21	Free Address Seat, 36H, Single
FA215	Free Address Seat, 36H, Single Plus
FA22	Free Address Seat, 36H, Double
FA23	Free Address Seat, 36H, Triple

2. Upholstery Style

		Upholstery Style
C	CASUAL	
P	PINCH	
S	STANDARD	
	Casual	
	Pinch	
	Standard	



3. Banquette

		Banquette
BQ	BANQUETTE	

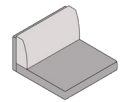
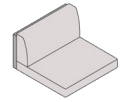

4. Dual Upholstery

		Dual Upholstery																				
DF1	DUAL UPHOLSTERY STYLE 1		36H Single	36H Single Plus	36H Double	36H Triple																
	Seat Cushion and Back Panel Back Cushion		C	P	S	C	P	S	C	P	S	C	P	S								
			3.6 yds	3.0	3.0	5.0	4.4	4.4	5.0	4.4	4.4	7.4	6.3	6.3								
			1.4 yds	1.4	1.4	1.9	1.9	1.9	2.5	2.5	2.5	3.9	3.9	3.9								
DF2	DUAL UPHOLSTERY STYLE 2		C	P	S	C	P	S	C	P	S	C	P	S								
	Back Panel Seat and Back Cushions		2.2 yds	2.2	2.2	3.0	3.0	3.0	2.5	2.5	2.5	3.3	3.3	3.3								
			2.8 yds	2.2	2.2	3.6	3.0	3.0	5.2	4.1	4.1	7.7	6.1	6.1								

5. Power

		Power
		Refer to under mount power ordering steps on page 12.

6. Upholstery

		Upholstery
		See general information section for details on textile program and COM/ COL information.
		Yardages provided are for fabrics cut railroaded. While that is generally our preference for Free Address, there may be exceptions if we decide that up the roll is more visually pleasing. If COM fabrics are to be cut up the roll, please contact customer service. Select highest grade in the case of dual upholstery.

Free Address

SEATS: 36H BANQUETTE CORNER

*Height when mounted on a frame.

Textile Upholstery Grades

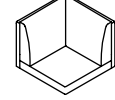
TITLE		SERIES	MODEL	SEAM	PANELS	DIMENSIONS	YDG	COM	A	B	C	D	E	F	G	H	I	J	K	L	M
Seat, 36H Banquette, Corner 	Casual Seam	FA	24	C	BQ	30W x 30D x 37.5H	5	3,311	3,663	3,859	4,048	4,241	4,436	4,647	4,859	5,109	5,431	5,818	6,202	6,591	6,973
	Pinch Seam	FA	24	P	BQ	30W x 30D x 37.5H	4.7	3,358	3,692	3,876	4,054	4,238	4,422	4,621	4,821	5,059	5,360	5,728	6,090	6,458	6,818
	Standard Seam	FA	24	S	BQ	30W x 30D x 37.5H	4.7	3,358	3,692	3,876	4,054	4,238	4,422	4,621	4,821	5,059	5,360	5,728	6,090	6,458	6,818

To Order Select Below

1. Series/Model

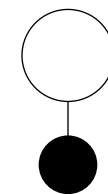

FA24

**Free Address
Seat, 36H, Corner**

2. Upholstery Style

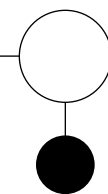

Upholstery Style

C CASUAL

P PINCH

S STANDARD

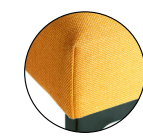

Casual

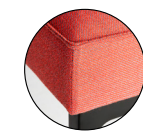

Pinch

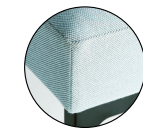

Standard

3. Banquette

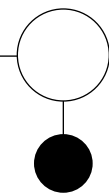

Banquette

BQ BANQUETTE

4. Dual Upholstery

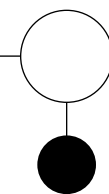

Dual Upholstery

DF1 DUAL UPHOLSTERY STYLE 1

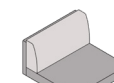
 Seat Cushion and Back Panel
Back Cushion

DF2 DUAL UPHOLSTERY STYLE 2

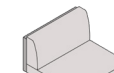
 Back Panel
Seat and Back Cushions

36H Corner

C P S

3.3 yds 3.0 3.0
2.2 yds 2.2 2.2

C P S

2.2 yds 2.2 2.2
3.0 yds 2.8 2.8

5. Upholstery

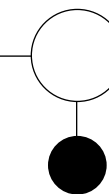

Upholstery

See general information section for details on textile program and COM/COL information.

Yardages provided are for fabrics cut railroaded. While that is generally our preference for Free Address, there may be exceptions if we decide that up the roll is more visually pleasing. If COM fabrics are to be cut up the roll, please contact customer service. Select highest grade in the case of dual upholstery.

Free Address

SEATS: 36H BANQUETTE, END PANEL LEFT/RIGHT

*Height when mounted on a frame.

Textile Upholstery Grades

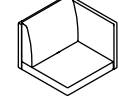
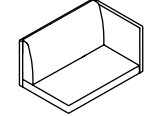
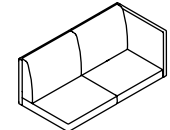
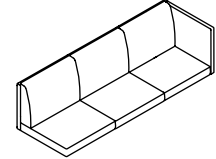
TITLE		SERIES	MODEL	SEAM	PANELS	DIMENSIONS	YDG	COM	A	B	C	D	E	F	G	H	I	J	K	L	M
Seat, 36H Banquette, Single End Panel Left or Right 	Casual Seam	FA	21	C	BQE36L/R	30W x 30D x 37.5H	5.2	2,928	3,301	3,506	3,705	3,911	4,116	4,339	4,562	4,828	5,165	5,576	5,981	6,390	6,795
	Pinch Seam	FA	21	P	BQE36L/R	30W x 30D x 37.5H	4.7	3,044	3,378	3,561	3,740	3,923	4,107	4,306	4,506	4,744	5,045	5,413	5,774	6,141	6,504
	Standard Seam	FA	21	S	BQE36L/R	30W x 30D x 37.5H	4.7	3,044	3,378	3,561	3,740	3,923	4,107	4,306	4,506	4,744	5,045	5,413	5,774	6,141	6,504
Seat, 36H Banquette, Single Plus End Panel Left or Right 	Casual Seam	FA	215	C	BQE36L/R	45W x 30D x 37.5H	6.6	3,364	3,838	4,096	4,348	4,606	4,866	5,147	5,430	5,766	6,192	6,710	7,220	7,739	8,249
	Pinch Seam	FA	215	P	BQE36L/R	45W x 30D x 37.5H	6.1	3,458	3,890	4,128	4,358	4,596	4,833	5,091	5,350	5,657	6,049	6,524	6,992	7,467	7,935
	Standard Seam	FA	215	S	BQE36L/R	45W x 30D x 37.5H	6.1	3,458	3,890	4,128	4,358	4,596	4,833	5,091	5,350	5,657	6,049	6,524	6,992	7,467	7,935
Seat, 36H Banquette, Double End Panel Left or Right 	Casual Seam	FA	22	C	BQE36L/R	60W x 30D x 37.5H	7.7	4,437	4,989	5,291	5,585	5,886	6,190	6,518	6,847	7,239	7,736	8,340	8,936	9,540	10,137
	Pinch Seam	FA	22	P	BQE36L/R	60W x 30D x 37.5H	7.2	4,583	5,095	5,376	5,648	5,929	6,210	6,516	6,821	7,184	7,646	8,208	8,761	9,323	9,876
	Standard Seam	FA	22	S	BQE36L/R	60W x 30D x 37.5H	7.2	4,583	5,095	5,376	5,648	5,929	6,210	6,516	6,821	7,184	7,646	8,208	8,761	9,323	9,876
Seat, 36H Banquette, Triple End Panel Left or Right 	Casual Seam	FA	23	C	BQE36L/R	90W x 30D x 37.5H	11	6,179	6,966	7,398	7,818	8,249	8,680	9,152	9,621	10,180	10,891	11,755	12,605	13,469	14,320
	Pinch Seam	FA	23	P	BQE36L/R	90W x 30D x 37.5H	9.9	6,399	7,107	7,496	7,873	8,262	8,650	9,073	9,496	9,999	10,640	11,417	12,182	12,959	13,726
	Standard Seam	FA	23	S	BQE36L/R	90W x 30D x 37.5H	9.9	6,399	7,107	7,496	7,873	8,262	8,650	9,073	9,496	9,999	10,640	11,417	12,182	12,959	13,726

To Order Select Below

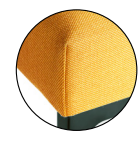
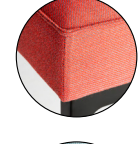
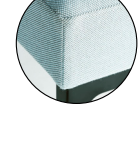
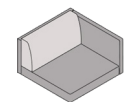
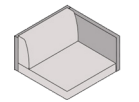
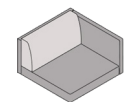
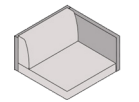
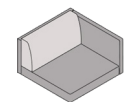
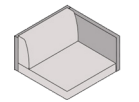
<p>1. Series/Model</p> <p>FA21 Free Address Seat, 36H, Single</p> <p>FA215 Free Address Seat, 36H, Single Plus</p> <p>FA22 Free Address Seat, 36H, Double</p> <p>FA23 Free Address Seat, 36H, Triple</p>	<p>2. Upholstery Style</p> <p>C CASUAL P PINCH S STANDARD</p>  Casual  Pinch  Standard	<p>3. Banquette</p> <p>BQ BANQUETTE</p>	<p>4. End Panel</p> <p>E36L 36H END PANEL LEFT E36R 36H END PANEL RIGHT</p>	<p>5. Dual Upholstery</p> <table border="1"> <thead> <tr> <th rowspan="2">Dual Upholstery</th> <th colspan="3">36H Single</th> <th colspan="3">36H Single Plus</th> <th colspan="3">36H Double</th> <th colspan="3">36H Triple</th> </tr> <tr> <th>C</th> <th>P</th> <th>S</th> <th>C</th> <th>P</th> <th>S</th> <th>C</th> <th>P</th> <th>S</th> <th>C</th> <th>P</th> <th>S</th> </tr> </thead> <tbody> <tr> <td>DF1 DUAL UPHOLSTERY STYLE 1  Seat Cushion, Back Panel, and End Panel Back Cushion</td> <td>4.1 yds</td> <td>3.9</td> <td>3.9</td> <td>5.2</td> <td>4.7</td> <td>4.7</td> <td>6.1</td> <td>5.2</td> <td>5.2</td> <td>8.3</td> <td>7.2</td> <td>7.2</td> </tr> <tr> <td></td> <td>1.4 yds</td> <td>1.4</td> <td>1.4</td> <td>1.7</td> <td>1.7</td> <td>1.7</td> <td>2.5</td> <td>2.5</td> <td>2.5</td> <td>3.9</td> <td>3.9</td> <td>3.9</td> </tr> <tr> <td>DF2 DUAL UPHOLSTERY STYLE 2  Back Panel and End Panel Seat and Back Cushions</td> <td>3.0 yds</td> <td>3.0</td> <td>3.0</td> <td>3.3</td> <td>3.3</td> <td>3.3</td> <td>3.3</td> <td>3.3</td> <td>3.3</td> <td>4.4</td> <td>4.4</td> <td>4.4</td> </tr> <tr> <td></td> <td>2.5 yds</td> <td>2.2</td> <td>2.2</td> <td>3.6</td> <td>2.8</td> <td>2.8</td> <td>5.0</td> <td>4.1</td> <td>4.1</td> <td>7.7</td> <td>5.8</td> <td>5.8</td> </tr> </tbody> </table>	Dual Upholstery	36H Single			36H Single Plus			36H Double			36H Triple			C	P	S	C	P	S	C	P	S	C	P	S	DF1 DUAL UPHOLSTERY STYLE 1  Seat Cushion, Back Panel, and End Panel Back Cushion	4.1 yds	3.9	3.9	5.2	4.7	4.7	6.1	5.2	5.2	8.3	7.2	7.2		1.4 yds	1.4	1.4	1.7	1.7	1.7	2.5	2.5	2.5	3.9	3.9	3.9	DF2 DUAL UPHOLSTERY STYLE 2  Back Panel and End Panel Seat and Back Cushions	3.0 yds	3.0	3.0	3.3	3.3	3.3	3.3	3.3	3.3	4.4	4.4	4.4		2.5 yds	2.2	2.2	3.6	2.8	2.8	5.0	4.1	4.1	7.7	5.8	5.8	<p>6. Power</p> <p>Refer to under mount power ordering steps on page 12.</p>	<p>7. Upholstery</p> <p>See general information section for details on textile program and COM/ COL information.</p> <p>Yardages provided are for fabrics cut railroaded. While that is generally our preference for Free Address, there may be exceptions if we decide that up the roll is more visually pleasing. If COM fabrics are to be cut up the roll, please contact customer service. Select highest grade in the case of dual upholstery.</p>
Dual Upholstery	36H Single			36H Single Plus			36H Double			36H Triple																																																																									
	C	P	S	C	P	S	C	P	S	C	P	S																																																																							
DF1 DUAL UPHOLSTERY STYLE 1  Seat Cushion, Back Panel, and End Panel Back Cushion	4.1 yds	3.9	3.9	5.2	4.7	4.7	6.1	5.2	5.2	8.3	7.2	7.2																																																																							
	1.4 yds	1.4	1.4	1.7	1.7	1.7	2.5	2.5	2.5	3.9	3.9	3.9																																																																							
DF2 DUAL UPHOLSTERY STYLE 2  Back Panel and End Panel Seat and Back Cushions	3.0 yds	3.0	3.0	3.3	3.3	3.3	3.3	3.3	3.3	4.4	4.4	4.4																																																																							
	2.5 yds	2.2	2.2	3.6	2.8	2.8	5.0	4.1	4.1	7.7	5.8	5.8																																																																							

Free Address

SEATS: 36H BANQUETTE, END PANEL BOTH

*Height when mounted on a frame.

Textile Upholstery Grades

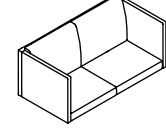
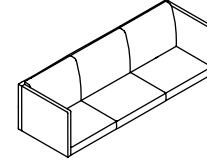
TITLE		SERIES	MODEL	SEAM	PANELS	DIMENSIONS	YDG	COM	A	B	C	D	E	F	G	H	I	J	K	L	M
Seat, 36H Banquette, Double End Panel Both 	Casual Seam	FA	22	C	BQE36B	60W x 30D x 37.5H	8.8	5,031	5,661	6,006	6,341	6,687	7,032	7,409	7,784	8,232	8,800	9,492	10,172	10,862	11,544
	Pinch Seam	FA	22	P	BQE36B	60W x 30D x 37.5H	8	5,177	5,749	6,062	6,365	6,678	6,991	7,331	7,672	8,078	8,593	9,219	9,836	10,462	11,080
	Standard Seam	FA	22	S	BQE36B	60W x 30D x 37.5H	8	5,177	5,749	6,062	6,365	6,678	6,991	7,331	7,672	8,078	8,593	9,219	9,836	10,462	11,080
Seat, 36H Banquette, Triple End Panel Both 	Casual Seam	FA	23	C	BQE36B	90W x 30D x 37.5H	11.8	6,669	7,516	7,980	8,430	8,896	9,359	9,864	10,370	10,970	11,735	12,663	13,578	14,506	15,421
	Pinch Seam	FA	23	P	BQE36B	90W x 30D x 37.5H	11	6,887	7,673	8,106	8,524	8,957	9,388	9,857	10,329	10,887	11,598	12,461	13,313	14,176	15,028
	Standard Seam	FA	23	S	BQE36B	90W x 30D x 37.5H	10.7	6,889	7,657	8,078	8,487	8,907	9,328	9,786	10,245	10,790	11,483	12,326	13,154	13,997	14,827

To Order Select Below

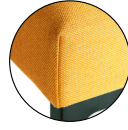
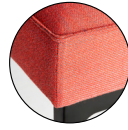
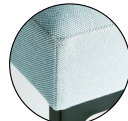
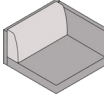
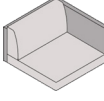
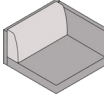
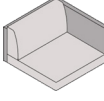
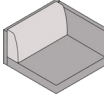
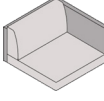
<p>1. Series/Model</p> <p>○</p> <p>●</p> <hr/> <p>FA22</p> <hr/> <p>Free Address Seat, 36H, Double</p> <hr/> <p>FA23</p> <hr/> <p>Free Address Seat, 36H, Triple</p>	<p>2. Upholstery Style</p> <p>○</p> <p>● Upholstery Style</p> <hr/> <p>C CASUAL</p> <hr/> <p>P PINCH</p> <hr/> <p>S STANDARD</p> <hr/> <p> Casual</p> <p> Pinch</p> <p> Standard</p>	<p>3. Banquette</p> <p>○</p> <p>● Banquette</p> <hr/> <p>BQ BANQUETTE</p>	<p>4. End Panel</p> <p>○</p> <p>● End Panel</p> <hr/> <p>E36B 36H END PANEL BOTH</p>	<p>5. Dual Upholstery</p> <p>○</p> <p>● Dual Upholstery</p> <table border="1" style="width: 100%; border-collapse: collapse;"> <thead> <tr> <th rowspan="2"></th> <th colspan="3">36H Double</th> <th colspan="3">36H Triple</th> </tr> <tr> <th>C</th> <th>P</th> <th>S</th> <th>C</th> <th>P</th> <th>S</th> </tr> </thead> <tbody> <tr> <td>DF1 DUAL UPHOLSTERY STYLE 1</td> <td></td><td></td><td></td><td></td><td></td><td></td> </tr> <tr> <td> Seat Cushion, Back Panel, and End Panels</td> <td>6.9 yds</td><td>6.1</td><td>6.3</td><td>9.1</td><td>8.0</td><td>8.3</td> </tr> <tr> <td>Back Cushion</td> <td>2.5 yds</td><td>2.5</td><td>2.5</td><td>3.6</td><td>3.6</td><td>3.6</td> </tr> <tr> <td>DF2 DUAL UPHOLSTERY STYLE 2</td> <td></td><td></td><td></td><td></td><td></td><td></td> </tr> <tr> <td> Back Panel and End Panels</td> <td>4.4 yds</td><td>4.4</td><td>4.4</td><td>5.2</td><td>5.2</td><td>5.2</td> </tr> <tr> <td>Seat and Back Cushions</td> <td>5.8 yds</td><td>5.8</td><td>5.8</td><td>7.4</td><td>5.8</td><td>5.8</td> </tr> </tbody> </table>		36H Double			36H Triple			C	P	S	C	P	S	DF1 DUAL UPHOLSTERY STYLE 1							 Seat Cushion, Back Panel, and End Panels	6.9 yds	6.1	6.3	9.1	8.0	8.3	Back Cushion	2.5 yds	2.5	2.5	3.6	3.6	3.6	DF2 DUAL UPHOLSTERY STYLE 2							 Back Panel and End Panels	4.4 yds	4.4	4.4	5.2	5.2	5.2	Seat and Back Cushions	5.8 yds	5.8	5.8	7.4	5.8	5.8	<p>6. Power</p> <p>○</p> <p>● Power</p> <p>Refer to under mount power ordering steps on page 12.</p>	<p>7. Upholstery</p> <p>○</p> <p>● Upholstery</p> <p>See general information section for details on textile program and COM/COL information.</p> <p>Yardages provided are for fabrics cut railroaded. While that is generally our preference for Free Address, there may be exceptions if we decide that up the roll is more visually pleasing. If COM fabrics are to be cut up the roll, please contact customer service. Select highest grade in the case of dual upholstery.</p>
	36H Double			36H Triple																																																									
	C	P	S	C	P	S																																																							
DF1 DUAL UPHOLSTERY STYLE 1																																																													
 Seat Cushion, Back Panel, and End Panels	6.9 yds	6.1	6.3	9.1	8.0	8.3																																																							
Back Cushion	2.5 yds	2.5	2.5	3.6	3.6	3.6																																																							
DF2 DUAL UPHOLSTERY STYLE 2																																																													
 Back Panel and End Panels	4.4 yds	4.4	4.4	5.2	5.2	5.2																																																							
Seat and Back Cushions	5.8 yds	5.8	5.8	7.4	5.8	5.8																																																							

Free Address

SEATS: 42H TASK

*Height when mounted on a frame.

Textile Upholstery Grades

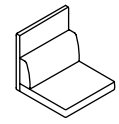
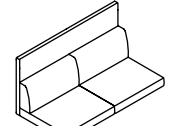
TITLE	SERIES	MODEL	SEAM	PANELS	DIMENSIONS	YDG	COM	A	B	C	D	E	F	G	H	I	J	K	L	M	
Seat, 42H, Single 	Casual Seam	FA	31	C	-	30W x 30D x 42.5H	4.4	2,161	2,477	2,649	2,817	2,989	3,163	3,351	3,539	3,761	4,046	4,392	4,732	5,078	5,418
	Pinch Seam	FA	31	P	-	30W x 30D x 42.5H	4.1	2,233	2,527	2,690	2,848	3,009	3,171	3,347	3,524	3,733	3,999	4,324	4,643	4,967	5,286
	Standard Seam	FA	31	S	-	30W x 30D x 42.5H	4.1	2,233	2,527	2,690	2,848	3,009	3,171	3,347	3,524	3,733	3,999	4,324	4,643	4,967	5,286
Seat, 42H, Single Plus 	Casual Seam	FA	315	C	-	45W x 30D x 42.5H	6.3	2,548	3,001	3,249	3,489	3,738	3,986	4,257	4,527	4,848	5,257	5,754	6,242	6,739	7,229
	Pinch Seam	FA	315	P	-	45W x 30D x 42.5H	5.8	2,638	3,051	3,278	3,499	3,725	3,952	4,198	4,446	4,738	5,112	5,566	6,012	6,465	6,912
	Standard Seam	FA	315	S	-	45W x 30D x 42.5H	5.8	2,638	3,051	3,278	3,499	3,725	3,952	4,198	4,446	4,738	5,112	5,566	6,012	6,465	6,912
Seat, 42H, Double 	Casual Seam	FA	32	C	-	60W x 30D x 42.5H	6.1	3,514	3,947	4,184	4,416	4,653	4,891	5,148	5,406	5,714	6,106	6,580	7,049	7,524	7,993
	Pinch Seam	FA	32	P	-	60W x 30D x 42.5H	6.3	3,656	4,110	4,358	4,598	4,847	5,095	5,364	5,636	5,957	6,366	6,863	7,352	7,849	8,338
	Standard Seam	FA	32	S	-	60W x 30D x 42.5H	5.5	3,656	4,051	4,266	4,476	4,691	4,908	5,143	5,377	5,656	6,012	6,445	6,870	7,302	7,727
Seat, 42H, Triple 	Casual Seam	FA	33	C	-	90W x 30D x 42.5H	9.4	5,003	5,672	6,040	6,396	6,762	7,130	7,529	7,929	8,403	9,009	9,742	10,465	11,199	11,923
	Pinch Seam	FA	33	P	-	90W x 30D x 42.5H	9.1	5,216	5,866	6,222	6,568	6,924	7,281	7,668	8,056	8,517	9,104	9,815	10,518	11,231	11,933
	Standard Seam	FA	33	S	-	90W x 30D x 42.5H	8.3	5,216	5,808	6,130	6,445	6,769	7,093	7,445	7,797	8,217	8,750	9,398	10,036	10,684	11,322

To Order Select Below

1. Series/Model

- FA31
**Free Address
Seat, 42H, Single**
- FA315
**Free Address
Seat, 42H, Single Plus**
- FA32
**Free Address
Seat, 42H, Double**
- FA33
**Free Address
Seat, 42H, Triple**

2. Upholstery Style

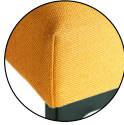
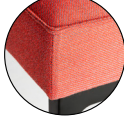
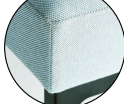
- Upholstery Style
 - C CASUAL
 - P PINCH
 - S STANDARD
-  Casual
-  Pinch
-  Standard

3. Dual Upholstery

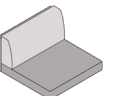
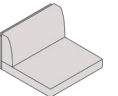
Dual Upholstery	42H Single			42H Single Plus			42H Double			42H Triple		
	C	P	S	C	P	S	C	P	S	C	P	S
DF1 DUAL UPHOLSTERY STYLE 1  Seat Cushion and Back Panel Back Cushion	3.6 yds	3.0	3.0	5.0	4.4	4.4	5.0	4.4	4.4	7.4	6.3	6.3
	1.1 yds	1.1	1.1	1.7	1.7	1.7	1.7	2.2	1.7	2.5	3.0	2.2
DF2 DUAL UPHOLSTERY STYLE 2  Back Panel Seat and Back Cushions	2.2 yds	2.2	2.2	3.0	3.0	3.0	2.5	2.5	2.5	3.3	3.3	3.3
	2.5 yds	2.2	2.2	3.3	3.0	3.0	3.9	3.9	3.6	6.1	5.8	5.2

4. Power

- Power
Refer to under mount
power ordering steps
on page 12.

5. Upholstery

- Upholstery
See general information
section for details on textile
program and COM/COL
information.
- Yardages provided are for fabrics cut railroaded. While that is generally our preference for Free Address, there may be exceptions if we decide that up the roll is more visually pleasing. If COM fabrics are to be cut up the roll, please contact customer service. Select highest grade in the case of dual upholstery.

Free Address

SEATS: 42H TASK CORNER

*Height when mounted on a frame.

Textile Upholstery Grades

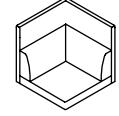
TITLE		SERIES	MODEL	SEAM	PANELS	DIMENSIONS	YDG	COM	A	B	C	D	E	F	G	H	I	J	K	L	M	
Seat, 42H, Corner		Casual Seam	FA	34	C	-	30W x 30D x 42.5H	4.4	3,059	3,374	3,546	3,714	3,886	4,059	4,247	4,435	4,659	4,943	5,289	5,629	5,973	6,316
		Pinch Seam	FA	34	P	-	30W x 30D x 42.5H	5	3,104	3,459	3,653	3,841	4,036	4,229	4,442	4,653	4,905	5,225	5,613	5,997	6,384	6,767
		Standard Seam	FA	34	S	-	30W x 30D x 42.5H	4.1	3,104	3,400	3,561	3,718	3,881	4,043	4,219	4,394	4,604	4,871	5,194	5,514	5,838	6,156

To Order Select Below

1. Series/Model

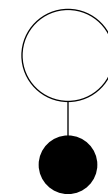

FA34

**Free Address
Seat, 42H, Corner**

2. Upholstery Style

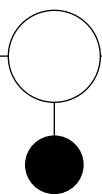

Upholstery Style

C	CASUAL
P	PINCH
S	STANDARD

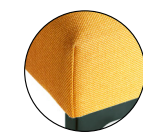

Casual

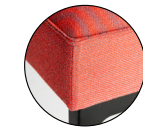

Pinch

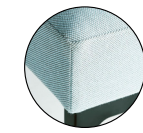

Standard

3. Dual Upholstery

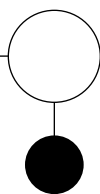

Dual Upholstery

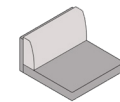
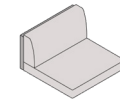
DF1	DUAL UPHOLSTERY STYLE 1	42H Corner		
		C	P	S
	Seat Cushion and Back Panel	3.6 yds	3.3	3.3
	Back Cushion	1.4 yds	1.7	1.4
DF2	DUAL UPHOLSTERY STYLE 2	C	P	S
	Back Panel	2.5 yds	2.5	2.5
	Seat and Back Cushions	2.2 yds	2.5	2.2

4. Upholstery

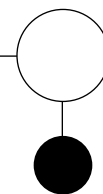

Upholstery

See general information section for details on textile program and COM/COL information.

Yardages provided are for fabrics cut railroaded. While that is generally our preference for Free Address, there may be exceptions if we decide that up the roll is more visually pleasing. If COM fabrics are to be cut up the roll, please contact customer service. Select highest grade in the case of dual upholstery.

Free Address

SEATS: 42H TASK, END PANEL LEFT/RIGHT

*Height when mounted on a frame.

Textile Upholstery Grades

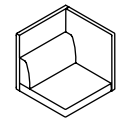
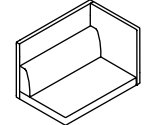
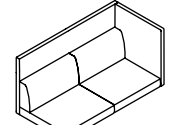
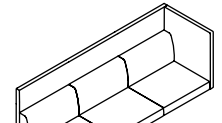
TITLE	SERIES	MODEL	SEAM	PANELS	DIMENSIONS	YDG	COM	A	B	C	D	E	F	G	H	I	J	K	L	M	
Seat, 42H, Single End Panel Left or Right 	Casual Seam	FA	31	C	E42L/R	30W x 30D x 42.5H	6.1	2,682	3,115	3,354	3,584	3,822	4,058	4,318	4,576	4,883	5,274	5,750	6,217	6,692	7,160
	Pinch Seam	FA	31	P	E42L/R	30W x 30D x 42.5H	5.8	2,793	3,206	3,432	3,653	3,880	4,107	4,353	4,599	4,893	5,267	5,720	6,167	6,620	7,068
	Standard Seam	FA	31	S	E42L/R	30W x 30D x 42.5H	5.8	2,793	3,206	3,432	3,653	3,880	4,107	4,353	4,599	4,893	5,267	5,720	6,167	6,620	7,068
Seat, 42H, Single Plus End Panel Left or Right 	Casual Seam	FA	315	C	E42L/R	45W x 30D x 42.5H	7.2	3,150	3,661	3,942	4,215	4,495	4,776	5,081	5,387	5,751	6,212	6,775	7,327	7,888	8,442
	Pinch Seam	FA	315	P	E42L/R	45W x 30D x 42.5H	6.6	3,240	3,713	3,971	4,223	4,481	4,741	5,023	5,305	5,641	6,067	6,586	7,096	7,614	8,125
	Standard Seam	FA	315	S	E42L/R	45W x 30D x 42.5H	6.6	3,240	3,713	3,971	4,223	4,481	4,741	5,023	5,305	5,641	6,067	6,586	7,096	7,614	8,125
Seat, 42H, Double End Panel Left or Right 	Casual Seam	FA	32	C	E42L/R	60W x 30D x 42.5H	8	4,201	4,772	5,085	5,389	5,703	6,015	6,356	6,696	7,102	7,617	8,245	8,861	9,487	10,104
	Pinch Seam	FA	32	P	E42L/R	60W x 30D x 42.5H	8.3	4,343	4,934	5,258	5,572	5,897	6,220	6,573	6,926	7,344	7,878	8,525	9,163	9,811	10,450
	Standard Seam	FA	32	S	E42L/R	60W x 30D x 42.5H	7.2	4,343	4,856	5,136	5,410	5,689	5,970	6,276	6,580	6,945	7,406	7,967	8,521	9,083	9,636
Seat, 42H, Triple End Panel Left or Right 	Casual Seam	FA	33	C	E42L/R	90W x 30D x 42.5H	11.3	5,629	6,437	6,879	7,309	7,751	8,193	8,675	9,157	9,729	10,459	11,344	12,217	13,101	13,974
	Pinch Seam	FA	33	P	E42L/R	90W x 30D x 42.5H	11	5,842	6,630	7,061	7,481	7,913	8,344	8,815	9,284	9,843	10,555	11,419	12,269	13,132	13,983
	Standard Seam	FA	33	S	E42L/R	90W x 30D x 42.5H	10.2	5,842	6,571	6,971	7,357	7,757	8,156	8,591	9,027	9,542	10,202	11,000	11,787	12,586	13,373

To Order Select Below

1. Series/Model

FA31	Free Address Seat, 42H, Single
FA315	Free Address Seat, 42H, Single Plus
FA32	Free Address Seat, 42H, Double
FA33	Free Address Seat, 42H, Triple

2. Upholstery Style

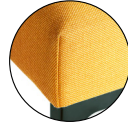
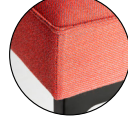
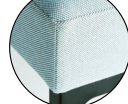
C	CASUAL	
P	PINCH	
S	STANDARD	

3. End Panel

E42L	42H END PANEL LEFT
E42R	42H END PANEL RIGHT

4. Dual Upholstery

Dual Upholstery	42H Single			42H Single Plus			42H Double			42H Triple		
	C	P	S	C	P	S	C	P	S	C	P	S
DF1 Seat Cushion, Back Panel, and End Panel Back Cushion	5.2 yds	5.0	4.7	5.8	5.2	5.2	7.2	6.3	6.3	9.4	10.5	8.3
	1.1 yds	1.1	1.1	1.4	1.7	1.4	1.7	1.9	1.7	2.2	3.0	2.2
DF2 Back Panel and End Panel Seat and Back Cushions	3.9 yds	3.9	3.9	3.9	3.9	3.9	4.4	4.4	4.4	5.5	5.5	5.5
	2.2 yds	1.9	1.9	3.9	2.8	2.8	3.9	3.9	3.3	6.1	5.0	5.2

5. Power

Power
Refer to under mount power ordering steps on page 12.

6. Upholstery

Upholstery
See general information section for details on textile program and COM/ COL information.

Yardages provided are for fabrics cut railroaded. While that is generally our preference for Free Address, there may be exceptions if we decide that up the roll is more visually pleasing. If COM fabrics are to be cut up the roll, please contact customer service. Select highest grade in the case of dual upholstery.

Free Address

SEATS: 42H TASK, END PANEL BOTH

*Height when mounted on a frame.

Textile Upholstery Grades

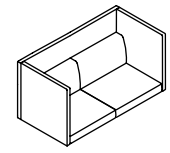
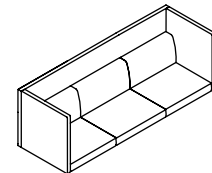
TITLE		SERIES	MODEL	SEAM	PANELS	DIMENSIONS	YDG	COM	A	B	C	D	E	F	G	H	I	J	K	L	M	
Seat, 42H, Double End Panel Both		Casual Seam	FA	32	C	E42B	60W x 30D x 42.5H	9.9	4,800	5,508	5,897	6,275	6,663	7,051	7,474	7,897	8,401	9,041	9,819	10,584	11,360	12,128
		Pinch Seam	FA	32	P	E42B	60W x 30D x 42.5H	10.2	4,942	5,670	6,069	6,458	6,858	7,257	7,691	8,125	8,643	9,300	10,099	10,886	11,685	12,473
		Standard Seam	FA	32	S	E42B	60W x 30D x 42.5H	9.1	4,942	5,591	5,948	6,294	6,650	7,006	7,394	7,782	8,244	8,829	9,541	10,244	10,957	11,658
Seat, 42H, Triple End Panel Both		Casual Seam	FA	33	C	E42B	90W x 30D x 42.5H	13.2	6,119	7,063	7,582	8,085	8,604	9,122	9,685	10,249	10,920	11,774	12,810	13,832	14,868	15,889
		Pinch Seam	FA	33	P	E42B	90W x 30D x 42.5H	12.9	6,334	7,259	7,767	8,259	8,766	9,274	9,826	10,378	11,034	11,870	12,886	13,885	14,900	15,900
		Standard Seam	FA	33	S	E42B	90W x 30D x 42.5H	12.1	6,334	7,200	7,674	8,136	8,612	9,086	9,602	10,120	10,734	11,516	12,468	13,403	14,354	15,290

To Order Select Below

1. Series/Model

FA32
Free Address Seat, 42H, Double

FA33
Free Address Seat, 42H, Triple

2. Upholstery Style

Upholstery Style

C CASUAL

P PINCH

S STANDARD

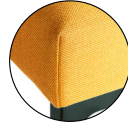
 **Casual**

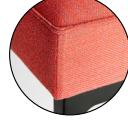
 **Pinch**

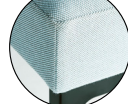
 **Standard**

3. End Panel

End Panel

E42B 42H END PANEL BOTH

4. Dual Upholstery

Dual Upholstery

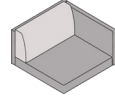
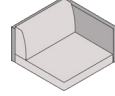
	42H Double			42H Triple		
	C	P	S	C	P	S
DF1 DUAL UPHOLSTERY STYLE 1  Seat Cushion, Back Panel, and End Panels Back Cushion	9.1 yds	8.3	8.3	11.3	10.2	10.2
	1.4 yds	1.9	1.4	2.2	3.0	2.2
DF2 DUAL UPHOLSTERY STYLE 2  Back Panel and End Panels Seat and Back Cushions	6.6 yds	6.6	6.6	7.4	7.4	7.4
	3.6 yds	3.9	3.9	5.8	5.8	5.0

5. Power

Power

Refer to under mount power ordering steps on page 12.

6. Upholstery

Upholstery

See general information section for details on textile program and COM/COL information.

Yardages provided are for fabrics cut railroaded. While that is generally our preference for Free Address, there may be exceptions if we decide that up the roll is more visually pleasing. If COM fabrics are to be cut up the roll, please contact customer service. Select highest grade in the case of dual upholstery.

Free Address

SEATS: 42H BANQUETTE

*Height when mounted on a frame.

Textile Upholstery Grades

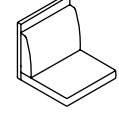
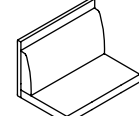
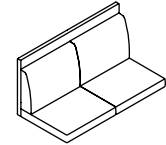
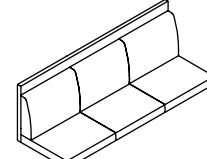
TITLE		SERIES	MODEL	SEAM	PANELS	DIMENSIONS	YDG	COM	A	B	C	D	E	F	G	H	I	J	K	L	M
Seat, 42H Banquette, Single 	Casual Seam	FA	31	C	BQ	30W x 30D x 42.5H	4.4	2,384	2,699	2,872	3,039	3,212	3,385	3,573	3,760	3,984	4,268	4,615	4,955	5,300	5,641
	Pinch Seam	FA	31	P	BQ	30W x 30D x 42.5H	4.1	2,457	2,753	2,915	3,072	3,234	3,397	3,572	3,747	3,957	4,224	4,549	4,867	5,191	5,510
	Standard Seam	FA	31	S	BQ	30W x 30D x 42.5H	4.1	2,457	2,753	2,915	3,072	3,234	3,397	3,572	3,747	3,957	4,224	4,549	4,867	5,191	5,510
Seat, 42H Banquette, Single Plus 	Casual Seam	FA	315	C	BQ	45W x 30D x 42.5H	6.3	2,772	3,224	3,472	3,714	3,963	4,211	4,480	4,750	5,072	5,481	5,978	6,466	6,963	7,453
	Pinch Seam	FA	315	P	BQ	45W x 30D x 42.5H	5.8	2,862	3,276	3,503	3,723	3,950	4,177	4,423	4,669	4,963	5,336	5,790	6,237	6,691	7,138
	Standard Seam	FA	315	S	BQ	45W x 30D x 42.5H	5.8	2,862	3,276	3,503	3,723	3,950	4,177	4,423	4,669	4,963	5,336	5,790	6,237	6,691	7,138
Seat, 42H Banquette, Double 	Casual Seam	FA	32	C	BQ	60W x 30D x 42.5H	7.4	3,932	4,464	4,754	5,038	5,330	5,622	5,939	6,255	6,633	7,113	7,695	8,270	8,854	9,427
	Pinch Seam	FA	32	P	BQ	60W x 30D x 42.5H	6.3	4,078	4,532	4,780	5,020	5,269	5,517	5,787	6,057	6,379	6,788	7,284	7,773	8,270	8,759
	Standard Seam	FA	32	S	BQ	60W x 30D x 42.5H	6.3	4,078	4,532	4,780	5,020	5,269	5,517	5,787	6,057	6,379	6,788	7,284	7,773	8,270	8,759
Seat, 42H Banquette, Triple 	Casual Seam	FA	33	C	BQ	90W x 30D x 42.5H	11	5,463	6,252	6,682	7,102	7,535	7,966	8,436	8,905	9,465	10,176	11,040	11,890	12,754	13,605
	Pinch Seam	FA	33	P	BQ	90W x 30D x 42.5H	9.1	5,684	6,334	6,690	7,035	7,391	7,748	8,135	8,523	8,985	9,571	10,283	10,985	11,698	12,401
	Standard Seam	FA	33	S	BQ	90W x 30D x 42.5H	9.1	5,684	6,334	6,690	7,035	7,391	7,748	8,135	8,523	8,985	9,571	10,283	10,985	11,698	12,401

To Order Select Below

1. Series/Model

<input type="radio"/>	<input checked="" type="radio"/>
FA31	Free Address Seat, 42H, Single
FA315	Free Address Seat, 42H, Single Plus
FA32	Free Address Seat, 42H, Double
FA33	Free Address Seat, 42H, Triple

2. Upholstery Style

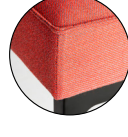
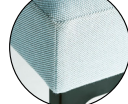
<input type="radio"/>	<input checked="" type="radio"/>
C CASUAL	<input type="radio"/>
P PINCH	<input type="radio"/>
S STANDARD	<input type="radio"/>
 Casual	
 Pinch	
 Standard	

3. Banquette

<input type="radio"/>	<input checked="" type="radio"/>
BQ BANQUETTE	

4. Dual Upholstery

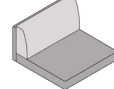
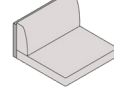
<input type="radio"/>	<input checked="" type="radio"/>																																																																														
Dual Upholstery																																																																															
DF1 DUAL UPHOLSTERY STYLE 1																																																																															
 Seat Cushion and Back Panel Back Cushion																																																																															
DF2 DUAL UPHOLSTERY STYLE 2																																																																															
 Back Panel Seat and Back Cushions																																																																															
	<table border="1"> <thead> <tr> <th></th> <th colspan="3">42H Single</th> <th colspan="3">42H Single Plus</th> <th colspan="3">42H Double</th> <th colspan="3">42H Triple</th> </tr> <tr> <th></th> <th>C</th> <th>P</th> <th>S</th> <th>C</th> <th>P</th> <th>S</th> <th>C</th> <th>P</th> <th>S</th> <th>C</th> <th>P</th> <th>S</th> </tr> </thead> <tbody> <tr> <td></td> <td>3.6 yds</td> <td>3.0</td> <td>3.0</td> <td>5.0</td> <td>4.4</td> <td>4.4</td> <td>5.0</td> <td>4.4</td> <td>4.4</td> <td>7.4</td> <td>6.3</td> <td>6.3</td> </tr> <tr> <td></td> <td>1.4 yds</td> <td>1.4</td> <td>1.4</td> <td>1.9</td> <td>1.9</td> <td>1.9</td> <td>2.5</td> <td>2.5</td> <td>2.5</td> <td>3.9</td> <td>3.9</td> <td>3.9</td> </tr> <tr> <td></td> <td>2.2 yds</td> <td>2.2</td> <td>2.2</td> <td>3.0</td> <td>3.0</td> <td>3.0</td> <td>2.5</td> <td>2.5</td> <td>2.5</td> <td>3.3</td> <td>3.3</td> <td>3.3</td> </tr> <tr> <td></td> <td>2.8 yds</td> <td>2.2</td> <td>2.2</td> <td>3.6</td> <td>3.0</td> <td>3.0</td> <td>5.2</td> <td>4.1</td> <td>4.1</td> <td>7.7</td> <td>6.1</td> <td>6.1</td> </tr> </tbody> </table>		42H Single			42H Single Plus			42H Double			42H Triple				C	P	S	C	P	S	C	P	S	C	P	S		3.6 yds	3.0	3.0	5.0	4.4	4.4	5.0	4.4	4.4	7.4	6.3	6.3		1.4 yds	1.4	1.4	1.9	1.9	1.9	2.5	2.5	2.5	3.9	3.9	3.9		2.2 yds	2.2	2.2	3.0	3.0	3.0	2.5	2.5	2.5	3.3	3.3	3.3		2.8 yds	2.2	2.2	3.6	3.0	3.0	5.2	4.1	4.1	7.7	6.1	6.1
	42H Single			42H Single Plus			42H Double			42H Triple																																																																					
	C	P	S	C	P	S	C	P	S	C	P	S																																																																			
	3.6 yds	3.0	3.0	5.0	4.4	4.4	5.0	4.4	4.4	7.4	6.3	6.3																																																																			
	1.4 yds	1.4	1.4	1.9	1.9	1.9	2.5	2.5	2.5	3.9	3.9	3.9																																																																			
	2.2 yds	2.2	2.2	3.0	3.0	3.0	2.5	2.5	2.5	3.3	3.3	3.3																																																																			
	2.8 yds	2.2	2.2	3.6	3.0	3.0	5.2	4.1	4.1	7.7	6.1	6.1																																																																			

5. Power

<input type="radio"/>	<input checked="" type="radio"/>
Power	
Refer to under mount power ordering steps on page 12.	

6. Upholstery

<input type="radio"/>	<input checked="" type="radio"/>
Upholstery	
See general information section for details on textile program and COM/ COL information.	
Yardages provided are for fabrics cut railroaded. While that is generally our preference for Free Address, there may be exceptions if we decide that up the roll is more visually pleasing. If COM fabrics are to be cut up the roll, please contact customer service. Select highest grade in the case of dual upholstery.	

Free Address

SEATS: 42H BANQUETTE CORNER

*Height when mounted on a frame.

Textile Upholstery Grades

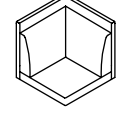
TITLE		SERIES	MODEL	SEAM	PANELS	DIMENSIONS	YDG	COM	A	B	C	D	E	F	G	H	I	J	K	L	M
Seat, 42H Banquette, Corner 	Casual Seam	FA	34	C	BQ	30W x 30D x 42.5H	5.2	3,436	3,809	4,014	4,214	4,419	4,624	4,847	5,070	5,335	5,673	6,084	6,489	6,899	7,303
	Pinch Seam	FA	34	P	BQ	30W x 30D x 42.5H	5	3,484	3,839	4,032	4,221	4,416	4,610	4,822	5,033	5,285	5,604	5,993	6,376	6,764	7,147
	Standard Seam	FA	34	S	BQ	30W x 30D x 42.5H	5	3,484	3,839	4,032	4,221	4,416	4,610	4,822	5,033	5,285	5,604	5,993	6,376	6,764	7,147

To Order Select Below

1. Series/Model

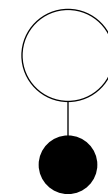

FA34

**Free Address
Seat, 42H, Corner**

2. Upholstery Style

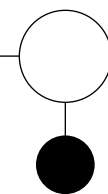

Upholstery Style

C CASUAL

P PINCH

S STANDARD

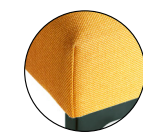

Casual

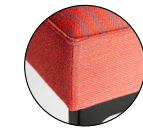

Pinch

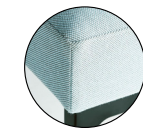

Standard

3. Banquette

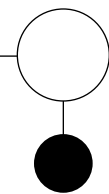

Banquette

BQ BANQUETTE

4. Dual Upholstery

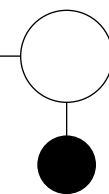

Dual Upholstery

DF1 DUAL UPHOLSTERY STYLE 1

 Seat Cushion and Back Panel
Back Cushion

DF2 DUAL UPHOLSTERY STYLE 2

 Back Panel
Seat and Back Cushions

42H Corner

C P S

3.6 yds 3.3 3.3
2.2 yds 2.2 2.2

C P S

2.5 yds 2.5 2.5
3.0 yds 2.8 2.8

5. Upholstery

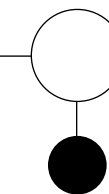

Upholstery

See general information section for details on textile program and COM/COL information.

Yardages provided are for fabrics cut railroaded. While that is generally our preference for Free Address, there may be exceptions if we decide that up the roll is more visually pleasing. If COM fabrics are to be cut up the roll, please contact customer service. Select highest grade in the case of dual upholstery.

Free Address

SEATS: 42H BANQUETTE, END PANEL LEFT/RIGHT

*Height when mounted on a frame.

Textile Upholstery Grades

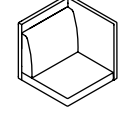
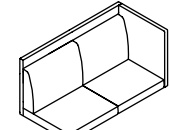
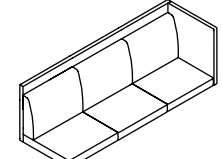
TITLE		SERIES	MODEL	SEAM	PANELS	DIMENSIONS	YDG	COM	A	B	C	D	E	F	G	H	I	J	K	L	M
Seat, 42H Banquette, Single End Panel Left or Right 	Casual Seam	FA	31	C	BQE42L/R	30W x 30D x 42.5H	6.1	3,018	3,450	3,688	3,919	4,156	4,394	4,653	4,910	5,219	5,609	6,084	6,552	7,028	7,496
	Pinch Seam	FA	31	P	BQE42L/R	30W x 30D x 42.5H	5.8	3,134	3,548	3,775	3,995	4,222	4,449	4,695	4,942	5,234	5,609	6,062	6,508	6,962	7,409
	Standard Seam	FA	31	S	BQE42L/R	30W x 30D x 42.5H	5.8	3,134	3,548	3,775	3,995	4,222	4,449	4,695	4,942	5,234	5,609	6,062	6,508	6,962	7,409
Seat, 42H Banquette, Single Plus End Panel Left or Right 	Casual Seam	FA	315	C	BQE42L/R	45W x 30D x 42.5H	7.2	3,402	3,914	4,195	4,468	4,748	5,030	5,334	5,640	6,004	6,465	7,027	7,580	8,141	8,694
	Pinch Seam	FA	315	P	BQE42L/R	45W x 30D x 42.5H	6.6	3,493	3,967	4,225	4,477	4,736	4,995	5,277	5,559	5,895	6,321	6,839	7,349	7,868	8,379
	Standard Seam	FA	315	S	BQE42L/R	45W x 30D x 42.5H	6.6	3,493	3,967	4,225	4,477	4,736	4,995	5,277	5,559	5,895	6,321	6,839	7,349	7,868	8,379
Seat, 42H Banquette, Double End Panel Left or Right 	Casual Seam	FA	32	C	BQE42L/R	60W x 30D x 42.5H	9.1	4,587	5,236	5,593	5,939	6,296	6,652	7,040	7,427	7,888	8,475	9,188	9,890	10,602	11,303
	Pinch Seam	FA	32	P	BQE42L/R	60W x 30D x 42.5H	8.3	4,734	5,326	5,650	5,964	6,288	6,611	6,964	7,316	7,735	8,269	8,917	9,555	10,203	10,841
	Standard Seam	FA	32	S	BQE42L/R	60W x 30D x 42.5H	8.3	4,734	5,326	5,650	5,964	6,288	6,611	6,964	7,316	7,735	8,269	8,917	9,555	10,203	10,841
Seat, 42H Banquette, Triple End Panel Left or Right 	Casual Seam	FA	33	C	BQE42L/R	90W x 30D x 42.5H	12.4	6,108	6,993	7,480	7,951	8,437	8,922	9,451	9,980	10,608	11,409	12,380	13,338	14,308	15,267
	Pinch Seam	FA	33	P	BQE42L/R	90W x 30D x 42.5H	11	6,327	7,115	7,546	7,966	8,397	8,829	9,300	9,769	10,329	11,040	11,904	12,754	13,619	14,469
	Standard Seam	FA	33	S	BQE42L/R	90W x 30D x 42.5H	11	6,327	7,115	7,546	7,966	8,397	8,829	9,300	9,769	10,329	11,040	11,904	12,754	13,619	14,469

To Order Select Below

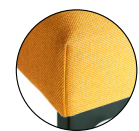
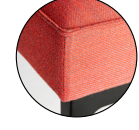
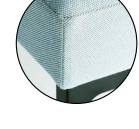
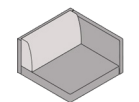
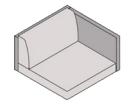
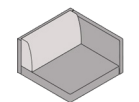
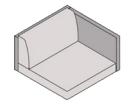
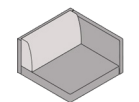
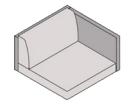
<p>1. Series/Model</p> <p>FA31 Free Address Seat, 42H, Single</p> <p>FA315 Free Address Seat, 42H, Single Plus</p> <p>FA32 Free Address Seat, 42H, Double</p> <p>FA33 Free Address Seat, 42H, Triple</p>	<p>2. Upholstery Style</p> <p>C CASUAL P PINCH S STANDARD</p>  Casual  Pinch  Standard	<p>3. Banquette</p> <p>BQ BANQUETTE</p>	<p>4. End Panel</p> <p>E42L 42H END PANEL LEFT E42R 42H END PANEL RIGHT</p>	<p>5. Dual Upholstery</p> <table border="1"> <thead> <tr> <th rowspan="2">Dual Upholstery</th> <th colspan="3">42H Single</th> <th colspan="3">42H Single Plus</th> <th colspan="3">42H Double</th> <th colspan="3">42H Triple</th> </tr> <tr> <th>C</th> <th>P</th> <th>S</th> <th>C</th> <th>P</th> <th>S</th> <th>C</th> <th>P</th> <th>S</th> <th>C</th> <th>P</th> <th>S</th> </tr> </thead> <tbody> <tr> <td>DF1 DUAL UPHOLSTERY STYLE 1  Seat Cushion, Back Panel, and End Panel Back Cushion</td> <td>5.2 yds</td> <td>5.0</td> <td>4.7</td> <td>5.8</td> <td>5.2</td> <td>5.2</td> <td>7.2</td> <td>6.3</td> <td>6.3</td> <td>9.4</td> <td>10.5</td> <td>8.3</td> </tr> <tr> <td></td> <td>1.4 yds</td> <td>1.4</td> <td>1.4</td> <td>1.7</td> <td>1.7</td> <td>1.7</td> <td>2.5</td> <td>2.5</td> <td>2.5</td> <td>3.9</td> <td>3.9</td> <td>3.9</td> </tr> <tr> <td>DF2 DUAL UPHOLSTERY STYLE 2  Back Panel and End Panel Seat and Back Cushions</td> <td>3.9 yds</td> <td>3.9</td> <td>3.9</td> <td>3.9</td> <td>3.9</td> <td>3.9</td> <td>4.4</td> <td>4.4</td> <td>4.4</td> <td>5.5</td> <td>5.5</td> <td>5.5</td> </tr> <tr> <td></td> <td>2.5 yds</td> <td>2.2</td> <td>2.2</td> <td>3.6</td> <td>2.8</td> <td>2.8</td> <td>5.0</td> <td>4.1</td> <td>4.1</td> <td>7.7</td> <td>6.1</td> <td>6.1</td> </tr> </tbody> </table>	Dual Upholstery	42H Single			42H Single Plus			42H Double			42H Triple			C	P	S	C	P	S	C	P	S	C	P	S	DF1 DUAL UPHOLSTERY STYLE 1  Seat Cushion, Back Panel, and End Panel Back Cushion	5.2 yds	5.0	4.7	5.8	5.2	5.2	7.2	6.3	6.3	9.4	10.5	8.3		1.4 yds	1.4	1.4	1.7	1.7	1.7	2.5	2.5	2.5	3.9	3.9	3.9	DF2 DUAL UPHOLSTERY STYLE 2  Back Panel and End Panel Seat and Back Cushions	3.9 yds	3.9	3.9	3.9	3.9	3.9	4.4	4.4	4.4	5.5	5.5	5.5		2.5 yds	2.2	2.2	3.6	2.8	2.8	5.0	4.1	4.1	7.7	6.1	6.1	<p>6. Power</p> <p>Refer to under mount power ordering steps on page 12.</p>	<p>7. Upholstery</p> <p>See general information section for details on textile program and COM/ COL information.</p> <p>Yardages provided are for fabrics cut railroaded. While that is generally our preference for Free Address, there may be exceptions if we decide that up the roll is more visually pleasing. If COM fabrics are to be cut up the roll, please contact customer service. Select highest grade in the case of dual upholstery.</p>
Dual Upholstery	42H Single			42H Single Plus			42H Double			42H Triple																																																																									
	C	P	S	C	P	S	C	P	S	C	P	S																																																																							
DF1 DUAL UPHOLSTERY STYLE 1  Seat Cushion, Back Panel, and End Panel Back Cushion	5.2 yds	5.0	4.7	5.8	5.2	5.2	7.2	6.3	6.3	9.4	10.5	8.3																																																																							
	1.4 yds	1.4	1.4	1.7	1.7	1.7	2.5	2.5	2.5	3.9	3.9	3.9																																																																							
DF2 DUAL UPHOLSTERY STYLE 2  Back Panel and End Panel Seat and Back Cushions	3.9 yds	3.9	3.9	3.9	3.9	3.9	4.4	4.4	4.4	5.5	5.5	5.5																																																																							
	2.5 yds	2.2	2.2	3.6	2.8	2.8	5.0	4.1	4.1	7.7	6.1	6.1																																																																							

Free Address

SEATS: 42H BANQUETTE, END PANEL BOTH

*Height when mounted on a frame.

Textile Upholstery Grades

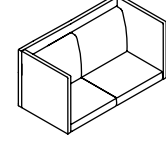
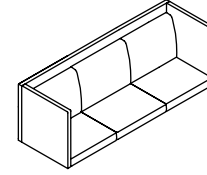
TITLE		SERIES	MODEL	SEAM	PANELS	DIMENSIONS	YDG	COM	A	B	C	D	E	F	G	H	I	J	K	L	M
Seat, 42H Banquette, Double End Panel Both 	Casual Seam	FA	32	C	BQE42B	60W x 30D x 42.5H	11	5,104	5,893	6,323	6,743	7,175	7,607	8,077	8,546	9,105	9,815	10,680	11,530	12,394	13,245
	Pinch Seam	FA	32	P	BQE42B	60W x 30D x 42.5H	10.2	5,250	5,979	6,379	6,766	7,166	7,565	7,999	8,435	8,950	9,610	10,408	11,195	11,994	12,782
	Standard Seam	FA	32	S	BQE42B	60W x 30D x 42.5H	10.2	5,250	5,979	6,379	6,766	7,166	7,565	7,999	8,435	8,950	9,610	10,408	11,195	11,994	12,782
Seat, 42H Banquette, Triple End Panel Both 	Casual Seam	FA	33	C	BQE42B	90W x 30D x 42.5H	14.3	6,736	7,760	8,321	8,867	9,428	9,990	10,601	11,211	11,937	12,861	13,985	15,092	16,214	17,320
	Pinch Seam	FA	33	P	BQE42B	90W x 30D x 42.5H	12.9	6,956	7,881	8,390	8,882	9,388	9,896	10,449	11,001	11,657	12,493	13,507	14,507	15,522	16,523
	Standard Seam	FA	33	S	BQE42B	90W x 30D x 42.5H	12.9	6,956	7,881	8,390	8,882	9,388	9,896	10,449	11,001	11,657	12,493	13,507	14,507	15,522	16,523

To Order Select Below

1. Series/Model

FA32

Free Address Seat, 42H, Double

FA33

Free Address Seat, 42H, Triple

2. Upholstery Style

Upholstery Style

C CASUAL

P PINCH

S STANDARD



Casual

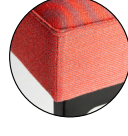

Pinch

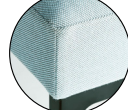

Standard

3. Banquette

Banquette

BQ BANQUETTE

4. End Panel

End Panel

E42B 42H END PANEL BOTH

5. Dual Upholstery

Dual Upholstery

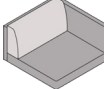
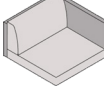
	42H Double			42H Triple		
	C	P	S	C	P	S
DF1 DUAL UPHOLSTERY STYLE 1  Seat Cushion, Back Panel, and End Panels Back Cushion	9.1 yds	8.3	8.3	11.3	10.2	10.2
	2.5 yds	2.5	2.5	3.6	3.6	3.6
DF2 DUAL UPHOLSTERY STYLE 2  Back Panel and End Panels Seat and Back Cushions	6.6 yds	6.6	6.6	7.4	7.4	7.4
	5.0 yds	3.9	3.9	7.4	5.8	5.8

6. Power

Power

Refer to under mount power ordering steps on page 12.

7. Upholstery

Upholstery



See general information section for details on textile program and COM/COL information.

Yardages provided are for fabrics cut railroaded. While that is generally our preference for Free Address, there may be exceptions if we decide that up the roll is more visually pleasing. If COM fabrics are to be cut up the roll, please contact customer service. Select highest grade in the case of dual upholstery.

Free Address

ARMS: TASK

Textile Upholstery Grades

TITLE	SERIES	MODEL	SEAM	PANELS	DIMENSIONS	YDG	COM	A	B	C	D	E	F	G	H	I	J	K	L	M
Arm, 2 Inch 	FA	42	-	-	2W x 30D x 26H	1.7	393	510	575	638	704	768	838	908	992	1,099	1,230	1,357	1,486	1,614
Arm, 4 Inch 	FA	44	-	-	4W x 30D x 26H	1.7	398	516	581	643	708	774	844	914	998	1,105	1,234	1,362	1,491	1,618
Arm, 6 Inch 	FA	46	-	-	6W x 30D x 26H	1.7	403	522	586	650	714	779	849	920	1,004	1,110	1,241	1,367	1,497	1,625

To Order Select Below

1. Series/Model

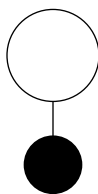

FA42

**Free Address
Arm, 2 Inch**

FA44

**Free Address
Arm, 4 Inch**

FA46

**Free Address
Arm, 6 Inch**

2. Upholstery

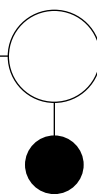

Upholstery







See general information section for details on textile program and COM/COL information.

Yardages provided are for fabrics cut railroaded. While that is generally our preference for Free Address, there may be exceptions if we decide that up the roll is more visually pleasing. If COM fabrics are to be cut up the roll, please contact customer service. Select highest grade in the case of dual upholstery.

Free Address

TABLE TOPS: SEAT HEIGHT, 15D

*Height when mounted on a frame.

TITLE	SERIES	MODEL	SIZE	DIMENSIONS	LM1	LM2	WV1
Table Top, 15D x 15W 	FA	5S	1515	15W x 15D	258	330	329
Table Top, 15D x 30W 	FA	5S	1530	30W x 15D	340	397	517
Table Top, 15D x 45W 	FA	5S	1545	45W x 15D	466	563	764
Table Top, 15D x 60W 	FA	5S	1560	60W x 15D	557	764	1,020
Table Top, 15D x 75W 	FA	5S	1575	75W x 15D	723	930	1,266
Table Top, 15D x 90W 	FA	5S	1590	90W x 15D	768	1,094	1,462

To Order Select Below

1. Series/Model

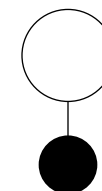

FA5S

**Free Address
Table Top, Seat Height**

2. Size

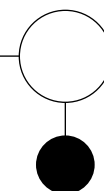

15" Deep

1515	15 X 15
1530	15 X 30
1545	15 X 45
1560	15 X 60
1575	15 X 75
1590	15 X 90

3. Top Finish

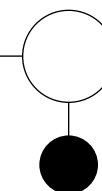

Laminate Grade 1

LM01	DESIGNER WHITE
LM02	ALABASTER
LM03	WALLABY
LM04	SHADOW
LM05	DOVE GRAY
LM06	FASHION GRAY
LM07	SLATE GRAY
LM08	NORTH SEA
LM09	BLACK

LM10	FUSION MAPLE
LM11	MONTICELLO MAPLE
LM12	RIVER CHERRY
LM13	AMBER CHERRY
LM14	WALNUT HEIGHTS
LM15	MONTANA WALNUT
LM16	XANADU
LM17	ASIAN NIGHT

Laminate wood pattern always runs in the length dimension.

Laminate Grade 2



LM41	BIANCO KOS
LM42	GRIGIO EFESO
LM43	GRIGIO LONDRA
LM44	GRIGIO BROMO
LM45	NERO INGO

Custom Top Finish

LM99	CUSTOM LAMINATE
WV99	CUSTOM WOOD VENEER

Refer to [page 10](#) for custom top details.

Veneer



WV01	LIGHT GRAY
WV02	WARM GRAY
WV03	OPAQUE BLACK
WV04	MEDIUM CHERRY
WV05	TONED ASH
WV06	NATURAL MAPLE
WV41	TONED RECON WALNUT
WV42	DARK TONED OAK

4. Power

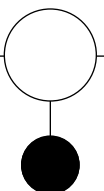

Power

Refer to under mount power ordering steps on [page 12](#).





WV43	TONED WENGE
WV44	TONED OAK
WV45	TONED RECON OAK
WV46	NATURAL FLAT CUT WALNUT
WV47	NATURAL RIFT CUT WALNUT
WV48	NATURAL WHITE OAK
WV49	NATURAL RECON WHITE OAK

Wood veneer grain direction always runs in the length dimension.

Free Address

TABLE TOPS: SEAT HEIGHT, 30D AND 45D

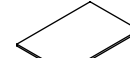
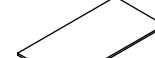
*Height when mounted on a frame.

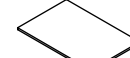
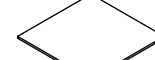
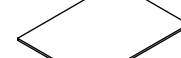
TITLE	SERIES	MODEL	SIZE	DIMENSIONS	LM1	LM2	WV1
Table Top, 30D x 15W 	FA	5S	3015	15W x 30D	341	395	519
Table Top, 30D x 30W 	FA	5S	3030	30W x 30D	574	697	974
Table Top, 30D x 45W 	FA	5S	3045	45W x 30D	811	990	1,424
Table Top, 30D x 60W 	FA	5S	3060	60W x 30D	975	1,327	1,874
Table Top, 45D x 15W 	FA	5S	4515	15W x 45D	467	563	764
Table Top, 45D x 30W 	FA	5S	4530	30W x 45D	812	989	1,424
Table Top, 45D x 45W 	FA	5S	4545	45W x 45D	1,028	1,387	2,070
Table Top, 45D x 60W 	FA	5S	4560	60W x 45D	1,229	1,800	2,751

To Order Select Below

1. Series/Model

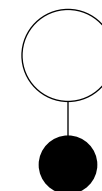

FA5S

Free Address
Table Top, Seat Height

2. Size

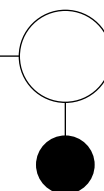

30" Deep

3015	30 X 15
3030	30 X 30
3045	30 X 45
3060	30 X 60

45" Deep

4515	45 X 15
4530	45 X 30
4545	45 X 45
4560	45 X 60

3. Top Finish

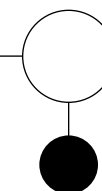

Laminate Grade 1

LM01	DESIGNER WHITE
LM02	ALABASTER
LM03	WALLABY
LM04	SHADOW
LM05	DOVE GRAY
LM06	FASHION GRAY
LM07	SLATE GRAY
LM08	NORTH SEA
LM09	BLACK

LM10	FUSION MAPLE
LM11	MONTICELLO MAPLE
LM12	RIVER CHERRY
LM13	AMBER CHERRY
LM14	WALNUT HEIGHTS
LM15	MONTANA WALNUT
LM16	XANADU
LM17	ASIAN NIGHT

Laminate wood pattern always runs in the length dimension.

Laminate Grade 2



LM41	BIANCO KOS
LM42	GRIGIO EFESO
LM43	GRIGIO LONDRA
LM44	GRIGIO BROMO
LM45	NERO INGO

Custom Top Finish

LM99	CUSTOM LAMINATE
WV99	CUSTOM WOOD VENEER

Refer to [page 10](#) for custom top details.

Veneer



WV01	LIGHT GRAY
WV02	WARM GRAY
WV03	OPAQUE BLACK
WV04	MEDIUM CHERRY
WV05	TONED ASH
WV06	NATURAL MAPLE
WV41	TONED RECON WALNUT
WV42	DARK TONED OAK

4. Power

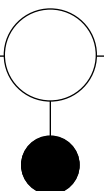

Power

Refer to under mount power ordering steps on [page 12](#).

WV43	TONED WENGE
WV44	TONED OAK
WV45	TONED RECON OAK
WV46	NATURAL FLAT CUT WALNUT
WV47	NATURAL RIFT CUT WALNUT
WV48	NATURAL WHITE OAK
WV49	NATURAL RECON WHITE OAK

Wood veneer grain direction always runs in the length dimension.

Free Address

TABLE TOPS: LEDGE HEIGHT, 15D

*Height when mounted on a frame.

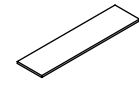
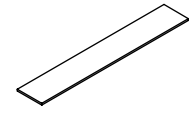
TITLE	SERIES	MODEL	SIZE	DIMENSIONS	LM1	LM2	WV1
Ledge Top, 15D x 30W 	FA	5L	1530	30W x 15D	340	397	517
Ledge Top, 15D x 60W 	FA	5L	1560	60W x 15D	557	764	1,020
Ledge Top, 15D x 90W 	FA	5L	1590	90W x 15D	768	1,094	1,462

To Order Select Below

1. Series/Model

○

●

FA5L

**Free Address
Table Top, Ledge Height**

2. Size

○

● **15" Deep**

1530	15 X 30
1560	15 X 60
1590	15 X 90

3. Top Finish

○

● **Laminate Grade 1**

LM01	DESIGNER WHITE
LM02	ALABASTER
LM03	WALLABY
LM04	SHADOW
LM05	DOVE GRAY
LM06	FASHION GRAY
LM07	SLATE GRAY
LM08	NORTH SEA
LM09	BLACK

LM10 FUSION MAPLE

LM11 MONTICELLO MAPLE

LM12 RIVER CHERRY

LM13 AMBER CHERRY

LM14 WALNUT HEIGHTS

LM15 MONTANA WALNUT

LM16 XANADU

LM17 ASIAN NIGHT

Laminate wood pattern always runs in the length dimension.

● **Laminate Grade 2**

LM41 BIANCO KOS

LM42 GRIGIO EFESO

LM43 GRIGIO LONDRA

LM44 GRIGIO BROMO

LM45 NERO INGO

● **Custom Top Finish**

LM99 CUSTOM LAMINATE

WV99 CUSTOM WOOD VENEER

Refer to [page 10](#) for custom top details.

● **Veneer**

WV01 LIGHT GRAY

WV02 WARM GRAY

WV03 OPAQUE BLACK

WV04 MEDIUM CHERRY

WV05 TONED ASH

WV06 NATURAL MAPLE

WV41 TONED RECON WALNUT

WV42 DARK TONED OAK

○

● **Power**

WV43 TONED WENGE

WV44 TONED OAK

WV45 TONED RECON OAK

WV46 NATURAL FLAT CUT WALNUT

WV47 NATURAL RIFT CUT WALNUT

WV48 NATURAL WHITE OAK

WV49 NATURAL RECON WHITE OAK









Wood veneer grain direction always runs in the length dimension.

Refer to under mount power ordering steps on page 12.

Free Address

CASE GOODS: CUBBY

*Height when mounted on a frame.

TITLE	SERIES	MODEL	SIZE	DIMENSIONS	LM1	LM2	WV1
Case Good, Cubby 29H, 15W Single 	FA	6C	1H29	15W x 15D x 29H	1,420	2,836	2,930
Case Good, Cubby 36H, 15W Single 	FA	6C	1H36	15W x 15D x 36H	1,972	3,986	3,509
Case Good, Cubby 42H, 15W Single 	FA	6C	1H42	15W x 15D x 42H	2,232	4,554	4,009
Case Good, Cubby 29H, 30W Double 	FA	6C	2H29	30W x 15D x 29H	1,813	3,217	3,101
Case Good, Cubby 36H, 30W Double 	FA	6C	2H36	30W x 15D x 36H	2,751	4,678	4,117
Case Good, Cubby 42H, 30W Double 	FA	6C	2H42	30W x 15D x 42H	2,906	5,048	4,443
Case Good, Cubby 29H, 45W Triple 	FA	6C	3H29	45W x 15D x 29H	2,270	3,653	3,489
Case Good, Cubby 29H, 60W Quad 	FA	6C	4H29	60W x 15D x 29H	2,810	4,449	3,904

To Order Select Below

1. Series/Model

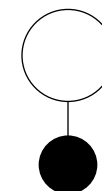

FA6C

**Free Address
Case Good, Cubby**

2. Size

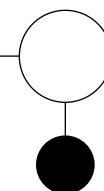

Single

1H29 15 X 29

1H36 15 X 36

1H42 15 X 42

Double

2H29 30 X 29

2H36 30 X 36

2H42 30 X 42

Triple/Quad

3H29 45 X 29

4H29 60 X 29

3. Top Finish

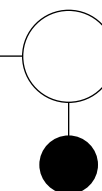

Laminate Grade 1

LM01 DESIGNER WHITE

LM02 ALABASTER

LM03 WALLABY

LM04 SHADOW

LM05 DOVE GRAY

LM06 FASHION GRAY

LM07 SLATE GRAY

LM08 NORTH SEA

LM09 BLACK

LM10 FUSION MAPLE

LM11 MONTICELLO MAPLE

LM12 RIVER CHERRY

LM13 AMBER CHERRY

LM14 WALNUT HEIGHTS

LM15 MONTANA WALNUT

LM16 XANADU

LM17 ASIAN NIGHT

Laminate wood pattern always runs in the length dimension.

Laminate Grade 2



LM41 BIANCO KOS

LM42 GRIGIO EFESO

LM43 GRIGIO LONDRA

LM44 GRIGIO BROMO

LM45 NERO INGO

Custom Top Finish

LM99 CUSTOM LAMINATE

WV99 CUSTOM WOOD VENEER

Refer to [page 10](#) for custom top details.

Veneer



WV01 LIGHT GRAY

WV02 WARM GRAY

WV03 OPAQUE BLACK

WV04 MEDIUM CHERRY

WV05 TONED ASH

WV06 NATURAL MAPLE

WV41 TONED RECON WALNUT

WV42 DARK TONED OAK

WV43 TONED WENGE

WV44 TONED OAK

WV45 TONED RECON OAK

WV46 NATURAL FLAT CUT WALNUT

WV47 NATURAL RIFT CUT WALNUT

WV48 NATURAL WHITE OAK

WV49 NATURAL RECON WHITE OAK

Wood veneer grain direction always runs in the length dimension.

4. Grain Direction

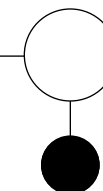

Grain Direction

FB FRONT/BACK

Left/Right is standard and is automatically applied if Front/Back is not specified.

Effective 5/15/2023, lockers, cubbies and shelves in Grade 1 laminate utilize butt-joint construction. Refer to page 21 for details. If the backs of any lockers, cubbies, and shelves will be exposed, we recommend utilizing mitered construction by specifying Grade 2 laminate, wood veneer, or a custom solution.

Free Address

CASE GOODS: CUBBY COMBO

*Height when mounted on a frame.

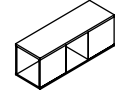
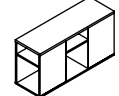
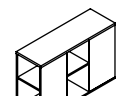
TITLE	SERIES	MODEL	SIZE	DIMENSIONS	LM1	LM2	WV1
Case Good Cubby Combo, 29H 	FA	6C	XH29	45W x 15D x 29H	2,553	5,457	5,169
Case Good Cubby Combo, 36H 	FA	6C	XH36	45W x 15D x 36H	3,754	5,690	5,381
Case Good Cubby Combo, 42H 	FA	6C	XH42	45W x 15D x 42H	3,994	6,048	5,723

To Order Select Below

1. Series/Model

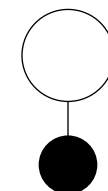

FA6C

Free Address Case Good, Cubby

2. Size

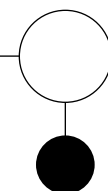

Combo

XH29 45 X 29

XH36 45 X 36

XH42 45 X 42

3. Top Finish

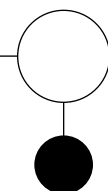

Laminate Grade 1

LM01 DESIGNER WHITE

LM02 ALABASTER

LM03 WALLABY

LM04 SHADOW

LM05 DOVE GRAY

LM06 FASHION GRAY

LM07 SLATE GRAY

LM08 NORTH SEA

LM09 BLACK

LM10 FUSION MAPLE

LM11 MONTICELLO MAPLE

LM12 RIVER CHERRY

LM13 AMBER CHERRY

LM14 WALNUT HEIGHTS

LM15 MONTANA WALNUT

LM16 XANADU

LM17 ASIAN NIGHT

Laminate wood pattern always runs in the length dimension.

Laminate Grade 2



LM41 BIANCO KOS

LM42 GRIGIO EFESO

LM43 GRIGIO LONDRA

LM44 GRIGIO BROMO

LM45 NERO INGO

Custom Top Finish

LM99 CUSTOM LAMINATE

WV99 CUSTOM WOOD VENEER

Refer to [page 10](#) for custom top details.

Veneer



WV01 LIGHT GRAY

WV02 WARM GRAY

WV03 OPAQUE BLACK

WV04 MEDIUM CHERRY

WV05 TONED ASH

WV06 NATURAL MAPLE

WV41 TONED RECON WALNUT

WV42 DARK TONED OAK

WV43 TONED WENGE

WV44 TONED OAK

WV45 TONED RECON OAK

WV46 NATURAL FLAT CUT WALNUT

WV47 NATURAL RIFT CUT WALNUT

WV48 NATURAL WHITE OAK

WV49 NATURAL RECON WHITE OAK

Wood veneer grain direction always runs in the length dimension.

4. Grain Direction

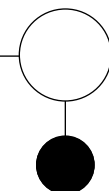

Grain Direction

FB FRONT/BACK

Left/Right is standard and is automatically applied if Front/Back is not specified.

Free Address

CASE GOODS: LOCKER

*Height when mounted on a frame.

TITLE		SERIES	MODEL	SIZE	DIMENSIONS	LM1	LM2	WV1
Case Good, Locker 29H, 15W Single		FA	6L	1H29	15W x 15D x 29H	1,761	3,271	3,589
Case Good, Locker 36H, 15W Single		FA	6L	1H36	15W x 15D x 36H	2,321	3,720	4,025
Case Good, Locker 42H, 15W Single		FA	6L	1H42	15W x 15D x 42H	2,616	4,250	4,607
Case Good, Locker 29H, 30W Double		FA	6L	2H29	30W x 15D x 29H	2,494	4,382	3,940
Case Good, Locker 36H, 30W Double		FA	6L	2H36	30W x 15D x 36H	3,150	4,041	4,375
Case Good, Locker 42H, 30W Double		FA	6L	2H42	30W x 15D x 42H	3,587	4,617	5,003
Case Good, Locker 29H, 45W Triple		FA	6L	3H29	45W x 15D x 29H	3,298	5,462	4,553
Case Good, Locker 29H, 60W Quad		FA	6L	4H29	60W x 15D x 29H	4,177	6,639	4,921

To Order Select Below

<p>1. Series/Model</p> <p>FA6L</p> <p>Free Address Case Good, Locker</p> <p>Effective 5/15/2023, lockers, cubbies and shelves in Grade 1 laminate utilize butt-joint construction. Refer to page 21 for details. If the backs of any lockers, cubbies, and shelves will be exposed, we recommend utilizing mitered construction by specifying Grade 2 laminate, wood veneer, or a custom solution.</p>	<p>2. Size</p> <p>Single</p> <p>1H29 15 X 29 1H36 15 X 36 1H42 15 X 42</p> <p>Double</p> <p>2H29 30 X 29 2H36 30 X 36 2H42 30 X 42</p> <p>Triple/Quad</p> <p>3H29 45 X 29 4H29 60 X 29</p>	<p>3. Top Finish</p> <p>Laminate Grade 1</p> <p>LM01 DESIGNER WHITE LM02 ALABASTER LM03 WALLABY LM04 SHADOW LM05 DOVE GRAY LM06 FASHION GRAY LM07 SLATE GRAY LM08 NORTH SEA LM09 BLACK LM10 FUSION MAPLE</p> <p>Laminate Grade 2</p> <p>LM11 MONTICELLO MAPLE LM12 RIVER CHERRY LM13 AMBER CHERRY LM14 WALNUT HEIGHTS LM15 MONTANA WALNUT LM16 XANADU LM17 ASIAN NIGHT</p> <p>Laminate wood pattern always runs in the length dimension.</p>	<p>Laminate Grade 2</p> <p>LM41 BIANCO KOS LM42 GRIGIO EFESO LM43 GRIGIO LONDRA LM44 GRIGIO BROMO LM45 NERO INGO</p> <p>Custom Top Finish</p> <p>LM99 CUSTOM LAMINATE WV99 CUSTOM WOOD VENEER</p> <p>Refer to page page 10 for custom top details.</p>	<p>Veneer</p> <p>WV01 LIGHT GRAY WV02 WARM GRAY WV03 OPAQUE BLACK WV04 MEDIUM CHERRY WV05 TONED ASH WV06 NATURAL MAPLE WV41 TONED RECON WALNUT WV42 DARK TONED OAK WV43 TONED WENGE WV44 TONED OAK</p>	<p>Lock</p> <p>WV45 TONED RECON OAK WV46 NATURAL FLAT CUT WALNUT WV47 NATURAL RIFT CUT WALNUT WV48 NATURAL WHITE OAK WV49 NATURAL RECON WHITE OAK</p> <p>Wood veneer grain direction always runs in the length dimension.</p>	<p>4. Door Hardware</p> <p>PXX* DOOR PULL (NO LOCK) KLB KEY LOCK BLACK +72/door KLW KEY LOCK WHITE +72/door NPB NUMBER PAD LOCK BLACK +274/door NPN NUMBER PAD LOCK NICKEL +274/door RFB RFID LOCK BLACK +357/door RFN RFID LOCK NICKEL +357/door</p> <p>* Replace xx with a standard powder coat paint color listed at the bottom of page 52. * Master keys required per order with locks (see page 16)</p>	<p>5. Options</p> <p>HG HINGE LEFT SIDE</p> <p>Default hinge on right side when facing front of locker.</p> <p>Grain Direction</p> <p>FB FRONT/BACK</p> <p>Left/Right is standard and is automatically applied if Front/Back is not specified.</p>
--	--	---	---	---	--	---	--

Free Address

CASE GOODS: LOCKER COMBO

*Height when mounted on a frame.

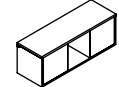
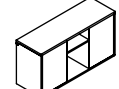
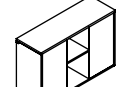
TITLE	SERIES	MODEL	SIZE	DIMENSIONS	LM1	LM2	WV1
Case Good Locker Combo, 29H 	FA	6L	XH29	45W x 15D x 29H	3,435	6,048	5,723
Case Good Locker Combo, 36H 	FA	6L	XH36	45W x 15D x 36H	4,565	6,305	5,964
Case Good Locker Combo, 42H 	FA	6L	XH42	45W x 15D x 42H	4,886	6,554	6,198

Left Hinge Options (Step 5) Top View

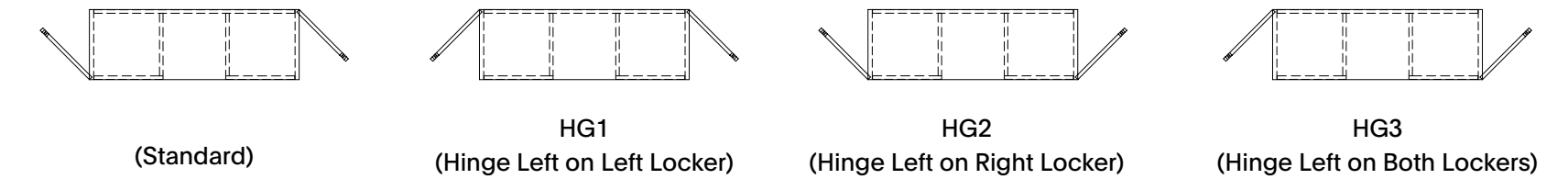









To Order Select Below

<p>1. Series/Model</p> <p>FA6L</p> <p>Free Address Case Good, Locker</p>	<p>2. Size</p> <p>Combo</p> <p>XH29 45 X 29</p> <p>XH36 45 X 36</p> <p>XH42 45 X 42</p>	<p>3. Top Finish</p> <p>Laminate Grade 1</p> <p>LM01 DESIGNER WHITE</p> <p>LM02 ALABASTER</p> <p>LM03 WALLABY</p> <p>LM04 SHADOW</p> <p>LM05 DOVE GRAY</p> <p>LM06 FASHION GRAY</p> <p>LM07 SLATE GRAY</p> <p>LM08 NORTH SEA</p> <p>LM09 BLACK</p> <p>LM10 FUSION MAPLE</p> <p>Laminate Grade 2</p> <p>LM11 MONTICELLO MAPLE</p> <p>LM12 RIVER CHERRY</p> <p>LM13 AMBER CHERRY</p> <p>LM14 WALNUT HEIGHTS</p> <p>LM15 MONTANA WALNUT</p> <p>LM16 XANADU</p> <p>LM17 ASIAN NIGHT</p> <p>Laminate wood pattern always runs in the length dimension.</p> <p>Custom Top Finish</p> <p>LM99 CUSTOM LAMINATE</p> <p>WV99 CUSTOM WOOD VENEER</p> <p>Refer to page page 10 for custom top details.</p>	<p>Laminate Grade 2</p> <p>LM41 BIANCO KOS</p> <p>LM42 GRIGIO EFESO</p> <p>LM43 GRIGIO LONDRA</p> <p>LM44 GRIGIO BROMO</p> <p>LM45 NERO INGO</p> <p>Veneer</p> <p>WV01 LIGHT GRAY</p> <p>WV02 WARM GRAY</p> <p>WV03 OPAQUE BLACK</p> <p>WV04 MEDIUM CHERRY</p> <p>WV05 TONED ASH</p> <p>WV06 NATURAL MAPLE</p> <p>WV41 TONED RECON WALNUT</p> <p>WV42 DARK TONED OAK</p> <p>WV43 TONED WENGE</p> <p>WV44 TONED OAK</p> <p>Wood veneer grain direction always runs in the length dimension.</p>	<p>4. Door Hardware</p> <p>Lock</p> <p>PXX* DOOR PULL (NO LOCK)</p> <p>KLB KEY LOCK BLACK +72 /door</p> <p>KLW KEY LOCK WHITE +72 /door</p> <p>NPB NUMBER PAD LOCK BLACK +274 /door</p> <p>NPN NUMBER PAD LOCK NICKEL +274 /door</p> <p>RFB RFID LOCK BLACK +357 /door</p> <p>RFN RFID LOCK NICKEL +357 /door</p> <p>* Replace xx with a standard powder coat paint color listed at the bottom of page 52.</p> <p>* Master keys required per order with locks (see page 16)</p>	<p>5. Options</p> <p>Hinge Left Side</p> <p>HG1 HLS ON LEFT LOCKER</p> <p>HG2 HLS ON RIGHT LOCKER</p> <p>HG3 HLS ON BOTH LOCKERS</p> <p>Default hinge on right side when facing front of locker.</p> <p>Grain Direction</p> <p>FB FRONT/BACK</p> <p>Left/Right is standard and is automatically applied if Front/Back is not specified.</p>
--	---	---	--	---	--

Free Address

CASE GOODS: PLANTER

*Height when mounted on a frame. Stylex will not be responsible for damage caused by improper use of planter liner.

TITLE	SERIES	MODEL	SIZE	DIMENSIONS	LM1	LM2	WV1
Case Good, Planter 29H, 15W Single 	FA	6P	1H29	15W x 15D x 29H	1,448	2,805	2,774
Case Good, Planter 36in Height, 15W Single 	FA	6P	1H36	15W x 15D x 36H	1,766	3,047	3,017
Case Good, Planter 42in Height, 15W Single 	FA	6P	1H42	15W x 15D x 42H	1,855	3,259	3,229
Case Good, Planter 29H, 30W Double 	FA	6P	2H29	30W x 15D x 29H	2,629	3,424	3,392
Case Good, Planter 36in Height, 30W Double 	FA	6P	2H36	30W x 15D x 36H	2,814	3,960	3,702
Case Good, Planter 42in Height, 30W Double 	FA	6P	2H42	30W x 15D x 42H	2,972	4,240	3,960
Case Good, Planter 29H, 45W Triple 	FA	6P	3H29	45W x 15D x 29H	4,117	4,155	4,117
Case Good, Planter 29H, 60W Quad 	FA	6P	4H29	60W x 15D x 29H	5,035	5,081	5,035

To Order Select Below

1. Series/Model

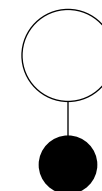

FA6P

Free Address Case Good, Planter

2. Size

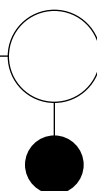

Single

1H29 15 X 29

1H36 15 X 36

1H42 15 X 42

Double

2H29 30 X 29

2H36 30 X 36

2H42 30 X 42

Triple/Quad

3H29 45 X 29

4H29 60 X 29

3. Top Finish

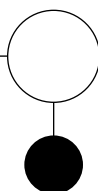

Laminate Grade 1

LM01 DESIGNER WHITE

LM02 ALABASTER

LM03 WALLABY

LM04 SHADOW

LM05 DOVE GRAY

LM06 FASHION GRAY

LM07 SLATE GRAY

LM08 NORTH SEA

LM09 BLACK

LM10 FUSION MAPLE

LM11 MONTICELLO MAPLE

LM12 RIVER CHERRY

LM13 AMBER CHERRY

LM14 WALNUT HEIGHTS

LM15 MONTANA WALNUT

LM16 XANADU

LM17 ASIAN NIGHT

Laminate wood pattern always runs in the length dimension.

Laminate Grade 2

LM41 BIANCO KOS

LM42 GRIGIO EFESO

LM43 GRIGIO LONDRA

LM44 GRIGIO BROMO

LM45 NERO INGO

Custom Top Finish

LM99 CUSTOM LAMINATE

WV99 CUSTOM WOOD VENEER

Refer to [page 10](#) for custom top details.

Veneer

WV01 LIGHT GRAY

WV02 WARM GRAY

WV03 OPAQUE BLACK

WV04 MEDIUM CHERRY

WV05 TONED ASH

WV06 NATURAL MAPLE

WV41 TONED RECON WALNUT

WV42 DARK TONED OAK

WV43 TONED WENGE

WV44 TONED OAK

WV45 TONED RECON OAK

WV46 NATURAL FLAT CUT WALNUT

WV47 NATURAL RIFT CUT WALNUT

WV48 NATURAL WHITE OAK



WV49 NATURAL RECON WHITE OAK

Wood veneer grain direction always runs in the length dimension.

Free Address

CASE GOODS: SHELVING

*Height when mounted on a frame.

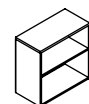
TITLE	SERIES	MODEL	SIZE	DIMENSIONS	LM1	LM2	WV1
Case Good, Shelving 29H 	FA	6S	H29	30W x 15D x 29H	1,954	3,266	3,091
Case Good, Shelving 36H 	FA	6S	H36	30W x 15D x 36H	2,380	3,765	3,561
Case Good, Shelving 42H 	FA	6S	H42	30W x 15D x 42H	2,589	3,999	3,787

To Order Select Below

1. Series/Model

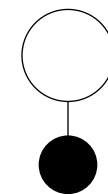

FA6S

**Free Address
Case Good, Shelving**

2. Height

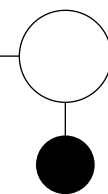

Height

H29 29 HIGH

H36 36 HIGH

H42 42 HIGH

3. Top Finish

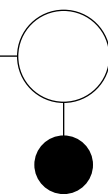

Laminate Grade 1

LM01 DESIGNER WHITE

LM02 ALABASTER

LM03 WALLABY

LM04 SHADOW

LM05 DOVE GRAY

LM06 FASHION GRAY

LM07 SLATE GRAY

LM08 NORTH SEA

LM09 BLACK

LM10 FUSION MAPLE

LM11 MONTICELLO MAPLE

LM12 RIVER CHERRY

LM13 AMBER CHERRY

LM14 WALNUT HEIGHTS

LM15 MONTANA WALNUT

LM16 XANADU

LM17 ASIAN NIGHT

Laminate wood pattern always runs in the length dimension.

Laminate Grade 2



LM41 BIANCO KOS

LM42 GRIGIO EFESO

LM43 GRIGIO LONDRA

LM44 GRIGIO BROMO

LM45 NERO INGO

Custom Top Finish

LM99 CUSTOM LAMINATE

WV99 CUSTOM WOOD VENEER

Refer to [page 10](#) for custom top details.

Veneer



WV01 LIGHT GRAY

WV02 WARM GRAY

WV03 OPAQUE BLACK

WV04 MEDIUM CHERRY

WV05 TONED ASH

WV06 NATURAL MAPLE

WV41 TONED RECON WALNUT

WV42 DARK TONED OAK

4. Grain Direction

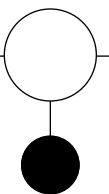

Grain Direction

FB FRONT/BACK

Left/Right is standard and is automatically applied if Front/Back is not specified.

WV43 TONED WENGE

WV44 TONED OAK

WV45 TONED RECON OAK

WV46 NATURAL FLAT CUT WALNUT

WV47 NATURAL RIFT CUT WALNUT

WV48 NATURAL WHITE OAK

WV49 NATURAL RECON WHITE OAK



Wood veneer grain direction always runs in the length dimension.

Effective 5/15/2023, lockers, cubbies and shelves in Grade 1 laminate utilize butt-joint construction. Refer to page 21 for details. If the backs of any lockers, cubbies, and shelves will be exposed, we recommend utilizing mitered construction by specifying Grade 2 laminate, wood veneer, or a custom solution.

Free Address

FRAMES: SEAT HEIGHT, 15D

*Glide height adjustability of seat height frames is 5/8"

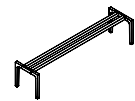
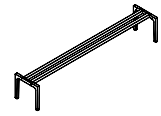
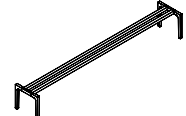
TITLE		SERIES	MODEL	SIZE	DIMENSIONS	PRICE
Frame, Seat Height 15D x 15W		FA	8S	D15L15	15W x 15D x 13H	694
Frame, Seat Height 15D x 30W		FA	8S	D15L30	30W x 15D x 13H	737
Frame, Seat Height 15D x 45W		FA	8S	D15L45	45W x 15D x 13H	847
Frame, Seat Height 15D x 60W		FA	8S	D15L60	60W x 15D x 13H	999
Frame, Seat Height 15D x 75W		FA	8S	D15L75	75W x 15D x 13H	1,078
Frame, Seat Height 15D x 90W		FA	8S	D15L90	90W x 15D x 13H	1,118

To Order Select Below

1. Series/Model

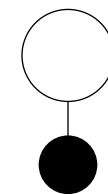

FA8S

**Free Address
Frame, Seat Height**

2. Size

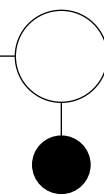

15" Depth

D15L15 15 X 15
 D15L30 15 X 30
 D15L45 15 X 45
 D15L60 15 X 60
 D15L75 15 X 75
 D15L90 15 X 90

3. Frame Finish

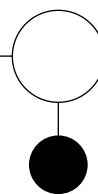

Standard Powder Coated Metal

BL BLUE	NK NICKEL
BM BLACK MATTE	NV NAVY
BR BRASS	OR ORANGE
BT BLACK TWILIGHT	PY PALE YELLOW
CP CHAMPAGNE	RD RED
DB DARK BRONZE	RO RED ORANGE
DG DARK GRAY	RR RUSTY RED
DP DUSTY PINK	SB SOFT BLUE
FG FOREST GREEN	SD SAND
LG LIGHT GRAY	TC TERRACOTTA
MG MEADOW GREEN	TP TAUPE
MK MILK	TS TEXTURED SLATE
MS METALLIC SILVER	YL YELLOW

Free Address

FRAMES: SEAT HEIGHT, 30D

*Glide height adjustability of seat height frames is 5/8"

TITLE		SERIES	MODEL	SIZE	DIMENSIONS	PRICE
Frame, Seat Height 30D x 15W		FA	8S	D30L15	15W x 30D x 13H	743
Frame, Seat Height 30D x 30W		FA	8S	D30L30	30W x 30D x 13H	931
Frame, Seat Height 30D x 45W		FA	8S	D30L45	45W x 30D x 13H	1,011
Frame, Seat Height 30D x 60W		FA	8S	D30L60	60W x 30D x 13H	1,202
Frame, Seat Height 30D x 75W		FA	8S	D30L75	75W x 30D x 13H	1,303
Frame, Seat Height 30D x 90W		FA	8S	D30L90	90W x 30D x 13H	1,358

To Order Select Below

1. Series/Model

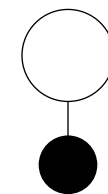

FA8S

Free Address
Frame, Seat Height

2. Size

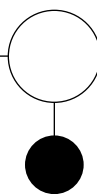

30" Depth

D30L15	30 X 15
D30L30	30 X 30
D30L45	30 X 45
D30L60	30 X 60
D30L75	30 X 75
D30L90	30 X 90

3. Frame Finish

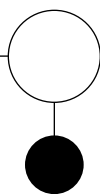

Standard Powder Coated Metal

BL	BLUE	NK	NICKEL
BM	BLACK MATTE	NV	NAVY
BR	BRASS	OR	ORANGE
BT	BLACK TWILIGHT	PY	PALE YELLOW
CP	CHAMPAGNE	RD	RED
DB	DARK BRONZE	RO	RED ORANGE
DG	DARK GRAY	RR	RUSTY RED
DP	DUSTY PINK	SB	SOFT BLUE
FG	FOREST GREEN	SD	SAND
LG	LIGHT GRAY	TC	TERRACOTTA
MG	MEADOW GREEN	TP	TAUPE
MK	MILK	TS	TEXTURED SLATE
MS	METALLIC SILVER	YL	YELLOW

Free Address

FRAMES: SEAT HEIGHT, 45D

*Glide height adjustability of seat height frames is 5/8"

TITLE		SERIES	MODEL	SIZE	DIMENSIONS	PRICE
Frame, Seat Height 45D x 15W		FA	8S	D45L15	15W x 45D x 13H	1,205
Frame, Seat Height 45D x 30W		FA	8S	D45L30	30W x 45D x 13H	1,369
Frame, Seat Height 45D x 45W		FA	8S	D45L45	45W x 45D x 13H	1,576
Frame, Seat Height 45D x 60W		FA	8S	D45L60	60W x 45D x 13H	1,728
Frame, Seat Height 45D x 75W		FA	8S	D45L75	75W x 45D x 13H	1,926
Frame, Seat Height 45D x 90W		FA	8S	D45L90	90W x 45D x 13H	2,011

To Order Select Below

1. Series/Model

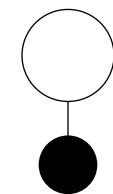

FA8S

**Free Address
Frame, Seat Height**

2. Size

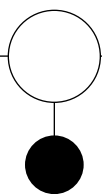

45" Depth

D45L15	45 X 15
D45L30	45 X 30
D45L45	45 X 45
D45L60	45 X 60
D45L75	45 X 75
D45L90	45 X 90

3. Frame Finish

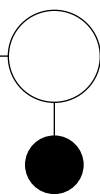

Standard Powder Coated Metal

BL	BLUE	NK	NICKEL
BM	BLACK MATTE	NV	NAVY
BR	BRASS	OR	ORANGE
BT	BLACK TWILIGHT	PY	PALE YELLOW
CP	CHAMPAGNE	RD	RED
DB	DARK BRONZE	RO	RED ORANGE
DG	DARK GRAY	RR	RUSTY RED
DP	DUSTY PINK	SB	SOFT BLUE
FG	FOREST GREEN	SD	SAND
LG	LIGHT GRAY	TC	TERRACOTTA
MG	MEADOW GREEN	TP	TAUPE
MK	MILK	TS	TEXTURED SLATE
MS	METALLIC SILVER	YL	YELLOW

Free Address

FRAMES: SEAT WITH LEDGE

*Shorter ledges can be used on taller back panels.

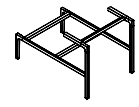
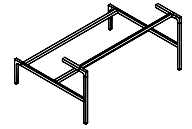
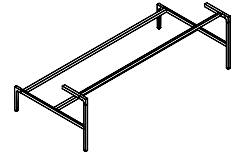
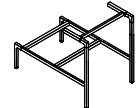
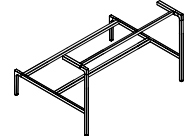
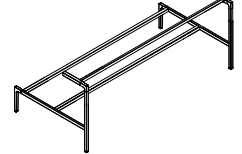
TITLE		SERIES	MODEL	SIZE	DIMENSIONS	PRICE
Frame, Seat with Ledge 29H, 30W		FA	8L	H29L30	30W x 30D x 29H	1,421
Frame, Seat with Ledge 29H, 60W		FA	8L	H29L60	60W x 30D x 29H	1,748
Frame, Seat with Ledge 29H, 90W		FA	8L	H29L90	90W x 30D x 29H	1,966
Frame, Seat with Ledge 36H, 30W		FA	8L	H36L30	30W x 30D x 36H	1,565
Frame, Seat with Ledge 36H, 60W		FA	8L	H36L60	60W x 30D x 36H	1,853
Frame, Seat with Ledge 36H, 90W		FA	8L	H36L90	90W x 30D x 36H	2,037

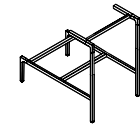
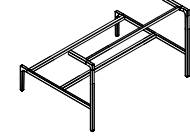
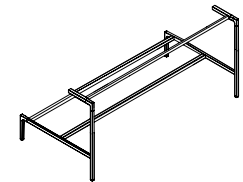
TITLE		SERIES	MODEL	SIZE	DIMENSIONS	PRICE
Frame, Seat with Ledge 42H, 30W		FA	8L	H42L30	30W x 30D x 42H	1,575
Frame, Seat with Ledge 42H, 60W		FA	8L	H42L60	60W x 30D x 42H	1,862
Frame, Seat with Ledge 42H, 90W		FA	8L	H42L90	90W x 30D x 42H	2,048

To Order Select Below

1. Series/Model

FA8L
Free Address
Frame, Seat with Ledge

2. Size

29" High

H29L30	29H X 30W	H42L30	42H X 30W
H29L60	29H X 60W	H42L60	42H X 60W
H29L90	29H X 90W	H42L90	42H X 90W

36" High

H36L30	36H X 30W
H36L60	36H X 60W
H36L90	36H X 90W

3. Frame Finish

Standard Powder Coated Metal

BL	BLUE	NK	NICKEL
BM	BLACK MATTE	NV	NAVY
BR	BRASS	OR	ORANGE
BT	BLACK TWILIGHT	PY	PALE YELLOW
CP	CHAMPAGNE	RD	RED
DB	DARK BRONZE	RO	RED ORANGE
DG	DARK GRAY	RR	RUSTY RED
DP	DUSTY PINK	SB	SOFT BLUE
FG	FOREST GREEN	SD	SAND
LG	LIGHT GRAY	TC	TERRACOTTA
MG	MEADOW GREEN	TP	TAUPE
MK	MILK	TS	TEXTURED SLATE
MS	METALLIC SILVER	YL	YELLOW

Free Address

TABLET ARM: UNDER MOUNT

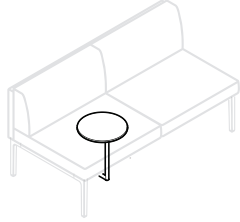
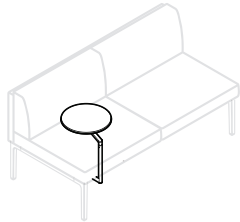
TITLE	SERIES	TYPE	DIMENSIONS	PRICE
Under Mount Tablet Arm, Single Swivel 	FA	TA1	14W X 14D	800
Under Mount Tablet Arm, Dual Swivel 	FA	TA2	14W X 14D	800

To Order Select Below

1. Series/Model

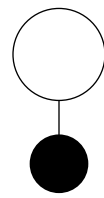

FATA1
Free Address
Tablet, Under Mount, Single Swivel

FATA2
Free Address
Tablet, Under Mount, Dual Swivel

2. Top Finish

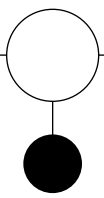

Wood Finish
 SW81 WHITE OAK
 SW83 MAPLE
 SW85 WALNUT **+70**
 SW87 OPAQUE BLACK

3. Finish

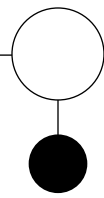



Standard Powder Coated Metal



BL BLUE	NK NICKEL
BM BLACK MATTE	NV NAVY
BR BRASS	OR ORANGE
BT BLACK TWILIGHT	PY PALE YELLOW
CP CHAMPAGNE	RD RED
DB DARK BRONZE	RO RED ORANGE
DG DARK GRAY	RR RUSTY RED
DP DUSTY PINK	SB SOFT BLUE
FG FOREST GREEN	SD SAND
LG LIGHT GRAY	TC TERRACOTTA
MG MEADOW GREEN	TP TAUPE
MK MILK	TS TEXTURED SLATE
MS METALLIC SILVER	YL YELLOW

Free Address

TABLES: FREESTANDING, 29H

*Glide height adjustability of 29H, 36H, and 42H tables is 1". Casters are not offered on table runs.

TITLE		SERIES	MODEL	SIZE	DIMENSIONS	LM1	LM2	WV1	
Table, Free Standing 29in Desk Height, 15D x 30W		FA	5D	1530	30W x 15D x 29H	1,481	1,388	1,508	
Table, Free Standing 29in Desk Height, 15D x 45W		FA	5D	1545	45W x 15D x 29H	1,701	1,636	1,840	
Table, Free Standing 29in Desk Height, 15D x 60W		FA	5D	1560	60W x 15D x 29H	1,817	1,861	2,116	

TITLE		SERIES	MODEL	SIZE	DIMENSIONS	LM1	LM2	WV1	
Table, Free Standing 29in Desk Height, 30D x 15W		FA	5D	3015	15W x 30D x 29H	1,514	1,413	1,531	
Table, Free Standing 29in Desk Height, 30D x 30W		FA	5D	3030	30W x 30D x 29H	1,780	1,745	2,023	
Table, Free Standing 29in Desk Height, 30D x 45W		FA	5D	3045	45W x 30D x 29H	2,112	2,122	2,556	
Table, Free Standing 29in Desk Height, 30D x 60W		FA	5D	3060	60W x 30D x 29H	2,302	2,480	3,028	

To Order Select Below

1. Series/Model

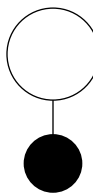

FA5D
Free Address Tables, Freestanding 29H Desk Height

2. Table Runs

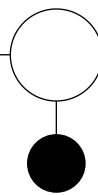
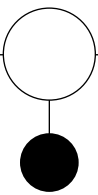

Table Runs

RS TABLE RUN, START
RM TABLE RUN, MID
RE TABLE RUN, END

Runs are for all tables except 15" length tops.

3. Size



15" Deep

1530 45D X 30W
1545 45D X 45W
1560 45D X 60W

30" Deep

3015 30D X 15W
3030 30D X 30W
3045 30D X 45W
3060 30D X 60W

4. Top Finish

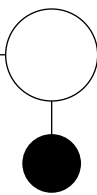

Laminate Grade 1

LM01 DESIGNER WHITE
LM02 ALABASTER
LM03 WALLABY
LM04 SHADOW
LM05 DOVE GRAY
LM06 FASHION GRAY
LM07 SLATE GRAY
LM08 NORTH SEA
LM09 BLACK
LM10 FUSION MAPLE
LM11 MONTICELLO MAPLE
LM12 RIVER CHERRY
LM13 AMBER CHERRY
LM14 WALNUT HEIGHTS
LM15 MONTANA WALNUT
LM16 XANADU
LM17 ASIAN NIGHT

Laminate wood pattern always runs in the length dimension.

Laminate Grade 2

LM41 BIANCO KOS
LM42 GRIGIO EFESO
LM43 GRIGIO LONDRA
LM44 GRIGIO BROMO
LM45 NERO INGO

Custom Top Finish

LM99 CUSTOM LAMINATE
WV99 CUSTOM WOOD VENEER

Refer to [page 10](#) for custom top details.

5. Frame Finish

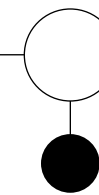

Standard Powder Coated Metal

BL BLUE
BM BLACK MATTE
BR BRASS
BT BLACK TWILIGHT
CP CHAMPAGNE
DB DARK BRONZE
DG DARK GRAY
DP DUSTY PINK
FG FOREST GREEN
LG LIGHT GRAY
MG MEADOW GREEN
MK MILK
MS METALLIC SILVER

NK NICKEL
NV NAVY
OR ORANGE
PY PALE YELLOW
RD RED
RO RED ORANGE
RR RUSTY RED
SB SOFT BLUE
SD SAND
TC TERRACOTTA
TP TAUPE
TS TEXTURED SLATE
YL YELLOW

Veneer

WV01 LIGHT GRAY
WV02 WARM GRAY
WV03 OPAQUE BLACK
WV04 MEDIUM CHERRY
WV05 TONED ASH
WV06 NATURAL MAPLE
WV41 TONED RECON WALNUT
WV42 DARK TONED OAK
WV43 TONED WENGE
WV44 TONED OAK
WV45 TONED RECON OAK
WV46 NATURAL FLAT CUT WALNUT
WV47 NATURAL RIFT CUT WALNUT
WV48 NATURAL WHITE OAK
WV49 NATURAL RECON WHITE OAK

Wood veneer grain direction always runs in the length dimension.

6. Options

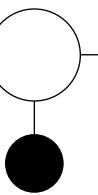

Screens

For screen options see [pages 60-65](#).

Power

Refer to under mount power ordering steps on [page 12](#) and the surface mount powder ordering steps on [page 13](#).

Casters

C1 HARD BLACK CASTERS **+47**
CS1 SOFT BLACK CASTERS **+63**

Free Address

TABLES: FREESTANDING, 29H

*Glide height adjustability of 29H, 36H, and 42H tables is 1". Casters are not offered on table runs.

TITLE		SERIES	MODEL	SIZE	DIMENSIONS	LM1	LM2	WV1	
Table, Free Standing 29in Desk Height, 45D x 15W		FA	5D	4515	15W x 45D x 29H	1,665	1,601	1,799	
Table, Free Standing 29in Desk Height, 45D x 30W		FA	5D	4530	30W x 45D x 29H	2,075	2,088	2,524	
Table, Free Standing 29in Desk Height, 45D x 45W		FA	5D	4545	45W x 45D x 29H	2,407	2,585	3,269	
Table, Free Standing 29in Desk Height, 45D x 60W		FA	5D	4560	60W x 45D x 29H	2,631	3,020	3,971	

TITLE		SERIES	MODEL	SIZE	DIMENSIONS	LM1	LM2	WV1	
Table, Free Standing 29in Desk Height, 60D x 15W		FA	5D	6015	15W x 60D x 29H	1,811	1,848	2,097	
Table, Free Standing 29in Desk Height, 60D x 30W		FA	5D	6030	30W x 60D x 29H	2,264	2,448	2,995	
Table, Free Standing 29in Desk Height, 60D x 45W		FA	5D	6045	45W x 60D x 29H	2,631	3,020	3,971	
Table, Free Standing 29in Desk Height, 60D x 60W		FA	5D	6060	60W x 60D x 29H	2,758	4,662	4,702	

To Order Select Below

1. Series/Model

FA5D
Free Address Tables, Freestanding 29H Desk Height

2. Table Runs

RS	TABLE RUN, START
RM	TABLE RUN, MID
RE	TABLE RUN, END
Runs are for all tables except 15" length tops.	

3. Size

45" Deep	
4515	45D X 15W
4530	45D X 30W
4545	45D X 45W
4560	45D X 60W
60" Deep	
6015	60D X 15W
6030	60D X 30W
6045	60D X 45W
6060	60D X 60W

4. Top Finish

Laminate Grade 1	
LM01	DESIGNER WHITE
LM02	ALABASTER
LM03	WALLABY
LM04	SHADOW
LM05	DOVE GRAY
LM06	FASHION GRAY
LM07	SLATE GRAY
LM08	NORTH SEA
LM09	BLACK
LM10	FUSION MAPLE
LM11	MONTICELLO MAPLE
LM12	RIVER CHERRY
LM13	AMBER CHERRY
LM14	WALNUT HEIGHTS
LM15	MONTANA WALNUT
LM16	XANADU
LM17	ASIAN NIGHT

Laminate wood pattern always runs in the length dimension.

Laminate Grade 2	
LM41	BIANCO KOS
LM42	GRIGIO EFESO
LM43	GRIGIO LONDRA
LM44	GRIGIO BROMO
LM45	NERO INGO
Custom Top Finish	
LM99	CUSTOM LAMINATE
WV99	CUSTOM WOOD VENEER

Refer to [page 10](#) for custom top details.

Veneer	
WV01	LIGHT GRAY
WV02	WARM GRAY
WV03	OPAQUE BLACK
WV04	MEDIUM CHERRY
WV05	TONED ASH
WV06	NATURAL MAPLE
WV41	TONED RECON WALNUT
WV42	DARK TONED OAK
WV43	TONED WENGE
WV44	TONED OAK
WV45	TONED RECON OAK
WV46	NATURAL FLAT CUT WALNUT
WV47	NATURAL RIFT CUT WALNUT
WV48	NATURAL WHITE OAK
WV49	NATURAL RECON WHITE OAK

Wood veneer grain direction always runs in the length dimension.

5. Frame Finish

Standard Powder Coated Metal			
BL	BLUE	NK	NICKEL
BM	BLACK MATTE	NV	NAVY
BR	BRASS	OR	ORANGE
BT	BLACK TWILIGHT	PY	PALE YELLOW
CP	CHAMPAGNE	RD	RED
DB	DARK BRONZE	RO	RED ORANGE
DG	DARK GRAY	RR	RUSTY RED
DP	DUSTY PINK	SB	SOFT BLUE
FG	FOREST GREEN	SD	SAND
LG	LIGHT GRAY	TC	TERRACOTTA
MG	MEADOW GREEN	TP	TAUPE
MK	MILK	TS	TEXTURED SLATE
MS	METALLIC SILVER	YL	YELLOW

6. Options

Screens	
For screen options see pages 59-64 .	
Power	
Refer to under mount power ordering steps on page 12 and the surface mount powder ordering steps on page 13 .	
Casters	
C1	HARD BLACK CASTERS +47
CS1	SOFT BLACK CASTERS +63

Free Address

TABLES: FREESTANDING, 36H AND 42H

*Glide height adjustability of 29H, 36H, and 42H tables is 1". Casters are not offered on table runs.

TITLE		SERIES	MODEL	SIZE	DIMENSIONS	LM1	LM2	WV1	
Table, Free Standing 36in Counter Height, 30D x 60W		FA	5C	3060	60W x 30D x 36H	2,669	2,800	3,346	
Table, Free Standing 36in Counter Height, 45D x 60W		FA	5C	4560	60W x 45D x 36H	3,020	3,358	4,309	
Table, Free Standing 36in Counter Height, 60D x 60W		FA	5C	6060	60W x 60D x 36H	3,174	5,421	5,063	

TITLE		SERIES	MODEL	SIZE	DIMENSIONS	LM1	LM2	WV1	
Table, Free Standing 42in Bar Height, 30D x 60W		FA	5B	3060	60W x 30D x 42H	2,745	2,865	3,414	
Table, Free Standing 42in Bar Height, 45D x 60W		FA	5B	4560	60W x 45D x 42H	3,074	3,404	4,356	
Table, Free Standing 42in Bar Height, 60D x 60W		FA	5B	6060	60W x 60D x 42H	3,228	5,454	5,109	

To Order Select Below

1. Series/Model

FA5C

**Free Address
Tables, Freestanding
36H Counter Height**

FA5B

**Free Address
Tables, Freestanding
42H Bar Height**

2. Table Runs

Table Runs

RS	TABLE RUN, START
RM	TABLE RUN, MID
RE	TABLE RUN, END

Runs are for all tables except 15" length tops.

3. Size

60" Length

3060	30D X 60L
4560	45D X 60L
6060	60D X 60L

4. Top Finish

Laminate Grade 1

LM01	DESIGNER WHITE
LM02	ALABASTER
LM03	WALLABY
LM04	SHADOW
LM05	DOVE GRAY
LM06	FASHION GRAY
LM07	SLATE GRAY
LM08	NORTH SEA
LM09	BLACK
LM10	FUSION MAPLE
LM11	MONTICELLO MAPLE
LM12	RIVER CHERRY
LM13	AMBER CHERRY
LM14	WALNUT HEIGHTS
LM15	MONTANA WALNUT
LM16	XANADU
LM17	ASIAN NIGHT

Laminate wood pattern always runs in the length dimension.

Laminate Grade 2

LM41	BIANCO KOS
LM42	GRIGIO EFESO
LM43	GRIGIO LONDRA
LM44	GRIGIO BROMO
LM45	NERO INGO

Custom Top Finish

LM99	CUSTOM LAMINATE
WV99	CUSTOM WOOD VENEER

Refer to [page 10](#) for custom top details.

Veneer

WV01	LIGHT GRAY
WV02	WARM GRAY
WV03	OPAQUE BLACK
WV04	MEDIUM CHERRY
WV05	TONED ASH
WV06	NATURAL MAPLE
WV41	TONED RECON WALNUT
WV42	DARK TONED OAK
WV43	TONED WENGE
WV44	TONED OAK
WV45	TONED RECON OAK
WV46	NATURAL FLAT CUT WALNUT
WV47	NATURAL RIFT CUT WALNUT
WV48	NATURAL WHITE OAK
WV49	NATURAL RECON WHITE OAK

Wood veneer grain direction always runs in the length dimension.

5. Frame Finish

Standard Powder Coated Metal

BL	BLUE
BM	BLACK MATTE
BR	BRASS
BT	BLACK TWILIGHT
CP	CHAMPAGNE
DB	DARK BRONZE
DG	DARK GRAY
DP	DUSTY PINK
FG	FOREST GREEN
LG	LIGHT GRAY
MG	MEADOW GREEN
MK	MILK
MS	METALLIC SILVER
NK	NICKEL
NV	NAVY
OR	ORANGE
PY	PALE YELLOW
RD	RED
RO	RED ORANGE
RR	RUSTY RED
SB	SOFT BLUE
SD	SAND
TC	TERRACOTTA
TP	TAUPE
TS	TEXTURED SLATE
YL	YELLOW

6. Options

Screens

For screen options see [pages 59-64](#).

Power

Refer to under mount power ordering steps on [page 12](#) and the surface mount powder ordering steps on [page 13](#).

Casters

C1	HARD BLACK CASTERS	+47
CS1	SOFT BLACK CASTERS	+63

Free Address

PRIVACY SCREENS: CENTER, 45L

*Height is from table top surface. Center screens are only available on 45", or 60" deep tables.

Textile Upholstery Grades

TITLE	SERIES	MODEL	HEIGHT	DIMENSIONS	YDG	COM	A	B	C	D	E	F	G	H	I	J	K	L	M
Privacy Screen, Center 45 Partial, Low	FA	7P	C41	27W x 1D x 10H	1.1	370	452	496	539	583	627	675	723	781	854	942	1,030	1,118	1,206
Privacy Screen, Center 45 Partial, Mid	FA	7P	C42	27W x 1D x 15H	1.1	411	492	537	580	624	668	715	764	822	895	983	1,071	1,159	1,247
Privacy Screen, Center 45 Full, Low	FA	7P	C46	43W x 1D x 10H	1.7	452	572	639	705	770	837	909	982	1,068	1,177	1,309	1,442	1,574	1,705
Privacy Screen, Center 45 Full, Mid	FA	7P	C47	43W x 1D x 15H	1.7	492	613	679	743	811	878	949	1,022	1,108	1,218	1,350	1,483	1,615	1,745

To Order Select Below

1. Series/Model

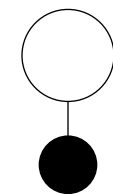

FA7PC4

**Free Address
Privacy Screen, Center, 45"**

2. Height

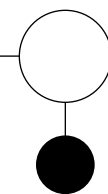

Partial

- 1 LOW
- 2 MID

Full

- 6 LOW
- 7 MID

3. Upholstery

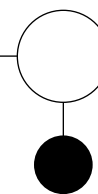

Upholstery

See general information section for details on textile program and COM/ COL information.

Yardages provided are for fabrics cut railroaded. While that is generally our preference for Free Address, there may be exceptions if we decide that up the roll is more visually pleasing. If COM fabrics are to be cut up the roll, please contact customer service.

Screens are tack-able surfaces. Please keep this in mind when specifying upholstery grade fabrics. Leathers and vinyls are not approved for use on screens.

Free Address

PRIVACY SCREENS: CENTER, 60L

*Height is from table top surface. Center screens are only available on 45", or 60" deep tables.

Textile Upholstery Grades

TITLE	SERIES	MODEL	HEIGHT	DIMENSIONS	YDG	COM	A	B	C	D	E	F	G	H	I	J	K	L	M
Privacy Screen, Center 60 Partial, Low	FA	7P	C61	42W x 1D x 10H	1.7	452	572	639	705	770	837	909	982	1,068	1,177	1,310	1,442	1,574	1,705
Privacy Screen, Center 60 Partial, Mid	FA	7P	C62	42W x 1D x 15H	1.7	491	612	678	742	810	876	948	1,021	1,107	1,217	1,349	1,479	1,614	1,744
Privacy Screen, Center 60 Full, Low	FA	7P	C66	58W x 1D x 10H	2.2	557	719	807	894	982	1,071	1,168	1,264	1,379	1,526	1,702	1,876	2,055	2,229
Privacy Screen, Center 60 Full, Mid	FA	7P	C67	58W x 1D x 15H	2.2	602	764	853	939	1,027	1,116	1,213	1,308	1,424	1,570	1,747	1,923	2,099	2,273

To Order Select Below

1. Series/Model

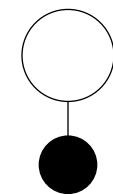

FA7PC6

**Free Address
Privacy Screen, Center, 60"**

2. Height

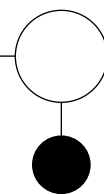

Partial

- 1 LOW
- 2 MID

Full

- 6 LOW
- 7 MID

3. Upholstery

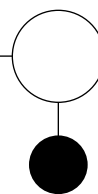

Upholstery

See general information section for details on textile program and COM/ COL information.

Yardages provided are for fabrics cut railroaded. While that is generally our preference for Free Address, there may be exceptions if we decide that up the roll is more visually pleasing. If COM fabrics are to be cut up the roll, please contact customer service.

Screens are tack-able surfaces. Please keep this in mind when specifying upholstery grade fabrics. Leathers and vinyls are not approved for use on screens.

Free Address

PRIVACY SCREENS: PERIMETER, 30W

*Height is from table top surface. 30" perimeter screens available on 30", 45", 60" long tables.
0.5" gap from screen to edge of table for cables/accessories.

Textile Upholstery Grades

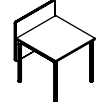
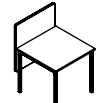
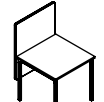
TITLE	SERIES	MODEL	HEIGHT	DIMENSIONS	YDG	COM	A	B	C	D	E	F	G	H	I	J	K	L	M
Privacy Screen, Perimeter 30W, Low 	FA	7P	P36	30W x 1D x 10H	2.2	581	742	832	918	1,006	1,094	1,191	1,288	1,403	1,549	1,726	1,901	2,078	2,253
Privacy Screen, Perimeter 30W, Mid 	FA	7P	P37	30W x 1D x 15H	2.2	613	776	864	950	1,038	1,128	1,223	1,321	1,435	1,582	1,759	1,933	2,111	2,286
Privacy Screen, Perimeter 30W, High 	FA	7P	P38	30W x 1D x 21H	2.2	657	820	908	994	1,083	1,172	1,269	1,365	1,479	1,626	1,803	1,978	2,156	2,330

To Order Select Below

1. Series/Model

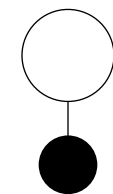

FA7PP3

**Free Address
Privacy Screen, Perimeter, 30"**

2. Height

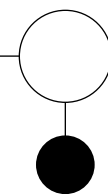

Height

6 LOW

7 MID

8 HIGH

3. Upholstery

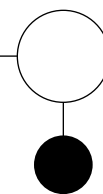

Upholstery

See general information section for details on textile program and COM/ COL information.

Yardages provided are for fabrics cut railroaded. While that is generally our preference for Free Address, there may be exceptions if we decide that up the roll is more visually pleasing. If COM fabrics are to be cut up the roll, please contact customer service.

Screens are tack-able surfaces. Please keep this in mind when specifying upholstery grade fabrics. Leathers and vinyls are not approved for use on screens.

Free Address

PRIVACY SCREENS: PERIMETER, 45W

*Height is from table top surface. All 45" long perimeter screens are available on 45", or 60" long tables.

Textile Upholstery Grades

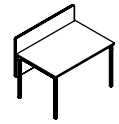
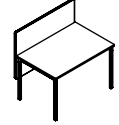
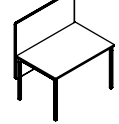
TITLE	SERIES	MODEL	HEIGHT	DIMENSIONS	YDG	COM	A	B	C	D	E	F	G	H	I	J	K	L	M
Privacy Screen, Perimeter 45W, Low 	FA	7P	P46	45W x 1D x 10H	3.3	678	920	1,053	1,182	1,316	1,448	1,593	1,738	1,910	2,128	2,395	2,657	2,923	3,186
Privacy Screen, Perimeter 45W, Mid 	FA	7P	P47	45W x 1D x 15H	3.3	717	960	1,092	1,221	1,355	1,487	1,632	1,777	1,948	2,168	2,434	2,695	2,962	3,224
Privacy Screen, Perimeter 45W, High 	FA	7P	P48	45W x 1D x 21H	3.3	764	1,007	1,139	1,269	1,403	1,535	1,679	1,825	1,997	2,216	2,482	2,745	3,009	3,273

To Order Select Below

1. Series/Model

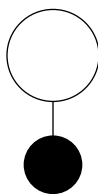

FA7PP4

**Free Address
Privacy Screen, Perimeter, 45"**

2. Height

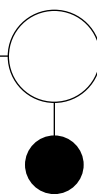

Height

6 LOW

7 MID

8 HIGH

3. Upholstery

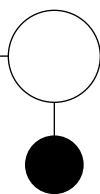

Upholstery

See general information section for details on textile program and COM/ COL information.

Yardages provided are for fabrics cut railroaded. While that is generally our preference for Free Address, there may be exceptions if we decide that up the roll is more visually pleasing. If COM fabrics are to be cut up the roll, please contact customer service.

Screens are tack-able surfaces. Please keep this in mind when specifying upholstery grade fabrics. Leathers and vinyls are not approved for use on screens.

Free Address

PRIVACY SCREENS: PERIMETER, 60W

*Height is from table top surface. All 60" long perimeter screens are available on 60" long tables only.

Textile Upholstery Grades

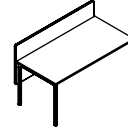
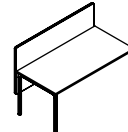
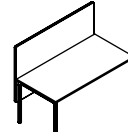
TITLE	SERIES	MODEL	HEIGHT	DIMENSIONS	YDG	COM	A	B	C	D	E	F	G	H	I	J	K	L	M
Privacy Screen, Perimeter 60W, Low 	FA	7P	P66	60W x 1D x 10H	4.4	924	1,247	1,424	1,597	1,775	1,952	2,144	2,337	2,567	2,859	3,214	3,563	3,918	4,267
Privacy Screen, Perimeter 60W, Mid 	FA	7P	P67	60W x 1D x 15H	4.4	1,011	1,336	1,513	1,685	1,862	2,040	2,233	2,426	2,654	2,947	3,302	3,652	4,007	4,355
Privacy Screen, Perimeter 60W, High 	FA	7P	P68	60W x 1D x 21H	4.4	1,079	1,403	1,579	1,752	1,929	2,107	2,300	2,493	2,723	3,015	3,369	3,718	4,073	4,423

To Order Select Below

1. Series/Model

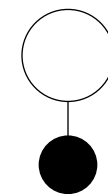

FA7PP6

**Free Address
Privacy Screen, Perimeter, 60"**

2. Height

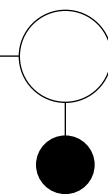

Height

6 LOW

7 MID

8 HIGH

3. Upholstery

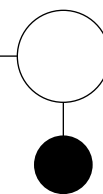

Upholstery

See general information section for details on textile program and COM/ COL information.

Yardages provided are for fabrics cut railroaded. While that is generally our preference for Free Address, there may be exceptions if we decide that up the roll is more visually pleasing. If COM fabrics are to be cut up the roll, please contact customer service.

Screens are tack-able surfaces. Please keep this in mind when specifying upholstery grade fabrics. Leathers and vinyls are not approved for use on screens.

Free Address

PRIVACY SCREENS: SIDE

*PS23 and PS24 are only available on 45" and 60" deep tables.

Textile Upholstery Grades

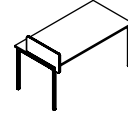
TITLE	SERIES	MODEL	HEIGHT	DIMENSIONS	YDG	COM	A	B	C	D	E	F	G	H	I	J	K	L	M
Privacy Screen, Side Quantity 1 	FA	7P	S21	25W x 1D x 10H	1.1	351	431	476	519	563	607	655	704	761	834	923	1,010	1,099	1,187

To Order Select Below

1. Series/Model

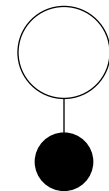

FA7PS2

Free Address
Privacy Screen, Side

2. Quantity

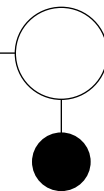

Quantity

- 1 QUANTITY 1
- 2 QUANTITY 2
- 3 QUANTITY 3
- 4 QUANTITY 4

3. Upholstery

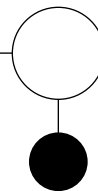

Upholstery

See general information section for details on textile program and COM/ COL information.

Yardages provided are for fabrics cut railroaded. While that is generally our preference for Free Address, there may be exceptions if we decide that up the roll is more visually pleasing. If COM fabrics are to be cut up the roll, please contact customer service.

Screens are tack-able surfaces. Please keep this in mind when specifying upholstery grade fabrics. Leathers and vinyls are not approved for use on screens.

Free Address

MODESTY SCREENS

*The bottom of modesty screens measure 13" from the floor.

Textile Upholstery Grades

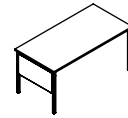
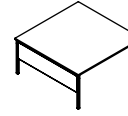
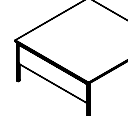
TITLE	SERIES	MODEL	HEIGHT	DIMENSIONS	YDG	COM	A	B	C	D	E	F	G	H	I	J	K	L	M
Privacy Screen, Modesty 30W End, Quantity 1 	FA	7M	E31	30W x 1D x 13H	1.1	425	506	550	593	637	681	731	778	836	908	998	1,086	1,174	1,261
Privacy Screen, Modesty 45W End, Quantity 1 	FA	7M	E41	45W x 1D x 13H	1.7	486	608	675	739	805	873	945	1,017	1,104	1,213	1,346	1,476	1,610	1,741
Privacy Screen, Modesty 60W End, Quantity 1 	FA	7M	E61	60W x 1D x 13H	2.2	585	747	835	921	1,010	1,099	1,195	1,292	1,406	1,553	1,729	1,904	2,082	2,256

To Order Select Below

1. Series/Model

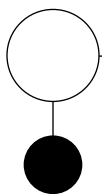

FA7ME3

**Free Address
Modesty, End for 30W**

FA7ME4

**Free Address
Modesty, End for 45W**

FA7ME6

**Free Address
Modesty, End for 60W**

2. Quantity

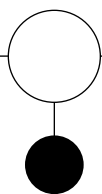

Quantity

1 QUANTITY 1

2 QUANTITY 2

3. Upholstery

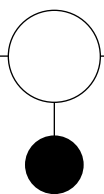

Upholstery

See general information section for details on textile program and COM/ COL information.

Yardages provided are for fabrics cut railroaded. While that is generally our preference for Free Address, there may be exceptions if we decide that up the roll is more visually pleasing. If COM fabrics are to be cut up the roll, please contact customer service.

Screens are tack-able surfaces. Please keep this in mind when specifying upholstery grade fabrics. Leathers and vinyls are not approved for use on screens.

stylex

Insight

PRICE LIST

Effective November 01, 2023

General Information

GENERAL INFORMATION

Terms

Net 30 days from date of invoice.
FOB Delanco, NJ

Damaged Shipments

All Stylex products are carefully inspected before they are packed in sturdy cartons designed to satisfy shipping requirements. Stylex is not responsible for damage in shipment. The transportation company assumes responsibility for delivering products to you in good condition when the bill of lading is signed. You protect yourself by refusing shipments showing damage or shortage until transportation company has noted on the delivery sheet the extent of damage or shortage. Concealed damage should be reported to the carrier as soon as discovered, but not later than 15 days after receiving shipment.

Return/Restocking Policy

Return shipments will not be accepted unless specifically authorized by Stylex in writing. The Return Authorization number should be clearly marked on the carton. The customer returning Stylex products is responsible for return shipping costs. Merchandise must be returned unused. Returned merchandise is subject to a 35% restocking fee.

Specials/Customs

Modifications to standard products will be considered for large runs. Contact Stylex for more information.

Design Changes

In keeping with modern manufacturing advances, Stylex reserves the right to incorporate minor modifications and design changes in products without notice.

Cancellation Policy

No charge prior to production except for inventory specifically requisitioned to fulfill the particular order. After production has begun, only actual costs incurred, including labor and material, will be billed to the customer.

WARRANTY

Except as provided below, Stylex warrants exclusively to the original Purchaser of our product that all parts, under normal use and service, will be free from defects in workmanship and material for a period of ten (10) years from the date of purchase. "Normal use and service" means that the product will be used in a typical office environment for 40-45 hours per week.

This warranty is subject to the following limitations, exclusions and provisions:

Wood components of plywood stacking chairs
(such as Brooks and Welcome)
5 years

Upholstery
(including mesh used for Click, F4, Insight, and Zephyr Mesh)
3 years

SAVA Mesh
10 years

COM Upholstery
No warranty
Stylex makes every effort to ensure that the COM Upholstery it approves is suitable for the intended use. Nevertheless, we will not warrant, and assume no responsibility for, the durability or tailoring quality of any COM or COL. If you have any concerns about the ultimate appearance of any covering, please order an upholstered sample.

Painted Stack Chair Frames
No Warranty
We will not warrant the finish of painted stack chair frames against damage from stacking. We recommend ordering chrome frames for chairs that will be stacked.

Felt Glides
No warranty
Due to the different surfaces on which felt glides may be used, we cannot warrant their durability over time.

If this product fails during normal use and service within the applicable warranty period (other than through normal wear and tear), please send a description of the relevant part and the nature of the defect, together with proof of purchase of the product, to Stylex at: Customer Service. c/o Stylex, P.O. Box 5038, Delanco, NJ 08075. PLEASE DO NOT RETURN PARTS OR THE PRODUCT TO STYLEX UNLESS INSTRUCTED TO DO SO BY STYLEX. Stylex will, at its option, either repair or replace the product or the part found defective by Stylex completely without charge for materials or labor. Purchaser may be required (at the option of Stylex) to return to Stylex at Purchaser's expense any defective part with all freight or shipping charges prepaid. The foregoing warranty shall be void if the product has been altered or repaired (other than by Stylex). The warranty does not cover damage to the product caused by accident, neglect, misuse, abuse, modification to the product by anyone other than Stylex or damage caused by use of the product for a purpose other than that for which it was designed. This warranty extends only to the original Purchaser of the product.

No Other Warranties

This warranty is in lieu of all other warranties, expressed or implied, including, but not limited to, implied warranties of merchantability and fitness for a particular purpose. The rights and remedies provided herein are the exclusive rights and remedies of the original purchaser of the product.

No Liability For Damages

In no event shall Stylex or its suppliers be responsible or liable for any special, indirect, consequential, or incidental damages. In no event shall the liability of Stylex exceed the actual purchase price paid to Stylex for the product.

Out of Warranty Products

For all products no longer covered by our warranty, please refer to our Design for Durability and Upgradability Policy. Contact Customer Service if you would like to purchase any replaceable components to further extend the life of any Stylex seating product. This warranty applies to all Stylex products purchased on April 13, 2018, and thereafter.

PRODUCT TAKE BACK PROGRAM

At Stylex, responsible stewardship of our products extends beyond their initial use. Our Product Take Back Program provides a practical solution for the end of our products' intended life cycle.

Through our partnership with ANEW, a 501(c)(3) nonprofit organization, we offer clients a comprehensive take-back solution for surplus office furniture and materials, regardless of their condition. ANEW's mission aligns with ours—to connect surplus resources with non-profits, public agencies, and underserved communities, minimizing landfill impact and maximizing corporate social responsibility.

By repurposing surplus items, we strengthen community networks and reduce environmental impact. Stylex proudly supports ANEW, integrating this partnership into our strategic sales strategy since 2014. Learn more at www.anewfound.org.

Initiate a Product Take Back through ANEW by emailing Stylex at info@stylexdesign.com. For additional end-of-life recovery options, refer to our Product Disassembly Instructions and End of Life Recovery Options documents, available in the Resources section of each product on our website. Together, let's build a sustainable future.

FREIGHT PROGRAM

Stylex offers a Guaranteed Freight Program, which provides the purchaser the ability to determine shipping and handling charges at the time of order. Freight charges will be calculated as a percentage of the net product price and added to the invoice at the time of shipment. The continental United States has been divided into three zones. Please use the map below to determine the freight charges for the product's destination. There is a minimum freight charge of \$150.

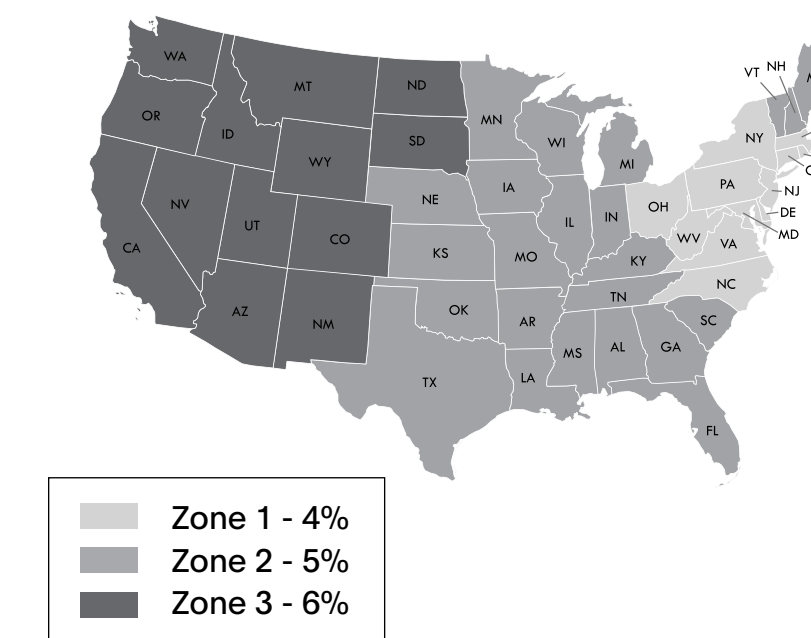

ZONE 1 - 4%

Connecticut
Delaware
New York
New Jersey
Maryland
Massachusetts
North Carolina
Ohio
Pennsylvania
Rhode Island
Virginia
Washington D.C.
West Virginia

ZONE 2 - 5%

Alabama
Arkansas
Canada, Ontario
Canada, Quebec
Florida
Georgia
Iowa
Illinois
Indiana
Kansas
Kentucky
Louisiana
Nebraska
New Hampshire
Oklahoma
Maine
Michigan
Minnesota
Mississippi
South Carolina
Tennessee
Texas
Vermont
Wisconsin

ZONE 3 - 6%

Arizona
California
Colorado
Idaho
Montana
Nevada
New Mexico
North Dakota
Oregon
South Dakota
Utah
Washington
Wyoming

Quote Per Project

Alaska
Hawaii
Canada
(outside Ontario & Quebec)
Mexico

General Information

TEXTILE PARTNERS & APPROVALS

Textile Partners

To customize your furniture performance needs and design vision, Stylex offers a wide selection of in-graded leathers and textiles from Grades A through Y. We've partnered with leading manufacturers on the options, focusing on color, price, durability, and construction. To view our partners and explore our digital carded program with broadly approved textiles, visit [this page](#). We stand by these textiles: They're tried and tested, and will effortlessly fit into any design aesthetic.

Textile Approvals

To view Stylex Approved Textile documents to determine specific product approval status, refer to our Product Tested Textiles documents, available in the Resources section of each product on our website.

CAL 117 AND 133 COMPLIANCE

CAL 117-2013

All Stylex seating satisfies the requirements of CAL 117-2013 so long as one of our standard or in-graded textiles is applied. COM textiles cannot be so guaranteed. Please contact the supplier of COM's directly to determine the fire retardancy of any COM supplied to us.

CAL 133

Most Stylex seating can be ordered to meet the requirements of CAL 133. When ordering, simply specify "CAL 133 compliance required". The upcharge for this option is \$54 list per yard. Please refer to the COM yardage of each model to determine the number of yards required. We do frequently require full-scale burn tests in order to certify CAL 133 before an order will be accepted. Such burn tests may increase normal lead times and do carry additional charges. Please contact customer service for details.

CUSTOMER'S OWN MATERIAL/LEATHER

Customer's own material (COM) and customer's own leather (COL) will generally be upholstered at the price designated in each product's price list. Please be advised, however, that we specifically reserve the right to charge a higher price when we determine that special circumstances, such as unusual repeats or challenging materials, present themselves. All orders for custom coverings must be approved by Stylex before they will be accepted for production. To submit proposed textile for approval, please use the COM form [here](#).

Special Note:

We assume no responsibility for the durability or tailoring quality of any COM or COL. Directional covers in particular may not meet your satisfaction due to the design of certain products. Please be advised that COM and COL orders are not subject to return. If you have doubts about the ultimate appearance of certain coverings, please order a sample done with that specific COM or COL. In addition, while we inspect textiles for mill imperfections, some are difficult to recognize. We cannot be responsible for defects, color inaccuracies, dye lot variations, or other flaws.

Under no circumstances will we be responsible for COM shortages, flaws, or other such problems. Finally, it is not our responsibility to police the receipt of COM's in order to meet delivery deadlines, and we assume our customers are aware of any undue delay in the shipment of their COM textiles.

COM textile and COL leather should be sent prepaid to: Stylex

**Attn: COM/COL - [Your PO #]
740 Coopertown Road
Delanco, NJ 08075**

Clearly mark textile or leather with the dealer's name, purchase order number, and furniture model number of the item to be covered. Actual furniture orders should include the same information, as well as a description of the textile or leather, including pattern and color number, in order to provide a cross reference.

Yardage requirements shown in the price list are based on non-directional goods of 54" width. Textiles less than 54" wide or those requiring matching (stripes, prints, or large patterned designs) call for additional yardage. We will be happy to supply yardage requirements for large quantities where economies may be realized.

Add the following yardage for stripes, plaids, or patterns with repeats:

Textile Width	Plain Textile	2-14" Repeat	15-24" Repeat	25-27" Repeat	28-36" Repeat
54"	0%	10%	15%	20%	25%
50"	10%	20%	25%	30%	35%
48"	15%	25%	30%	35%	40%
45"	40%	50%	55%	60%	65%
36"	50%	60%	65%	70%	75%

COM/COL FORM

To avoid delay in processing COM orders we request that you submit a sample of your COM textile stapled to this form which can be downloaded [here](#). If a textile has a stripe or design, the size of the repeat should be indicated. Please indicate the textile supplier's name, textile number, and color. Also indicate the Stylex product on which the textile will be used.

The textile supplier must indicate on his shipping labels the dealer name and purchase order number as well as the Stylex model number.

Please Note:

No order may be entered into production or have a shipping date assigned until all related COM is received at the factory.



CENTER OF STRIPE OR DESIGN

TOP	TOP
-----	-----

1. Size of Repeat

2. Textile Supplier

3. Textile Number

4. Color

5. Stylex Product

Contents

<hr/>		<hr/>	
COLORS, MATERIALS, AND FINISHES	5	CHAIR: MESH BACK	9
<hr/>		<hr/>	
STATEMENT OF LINE	6	CHAIR: UPHOLSTERED BACK	12
<hr/>		<hr/>	
DIMENSIONS	7	STOOL	15
<hr/>		<hr/>	
HOW TO ORDER	8	EXECUTIVE CHAIR	18
<hr/>		<hr/>	

CLICK THE TITLES ABOVE TO NAVIGATE THROUGH THE DOCUMENT
PRODUCT HEADERS ON SUBSEQUENT PAGES LINK BACK TO THIS PAGE

Insight

COLORS, MATERIALS, AND FINISHES

POWDER PAINT FINISHES

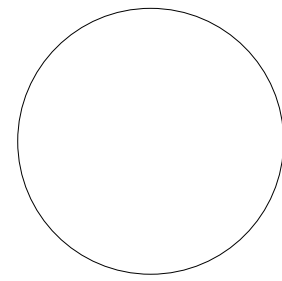

MILK
(MK)

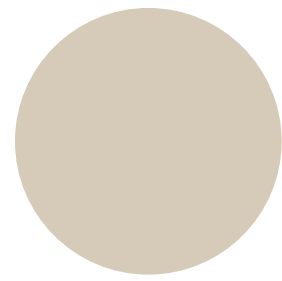

SAND
(SD)

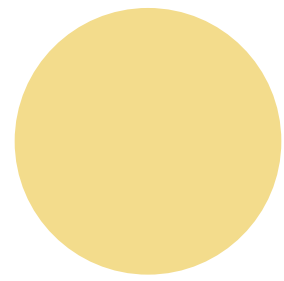

PALE YELLOW
(PY)

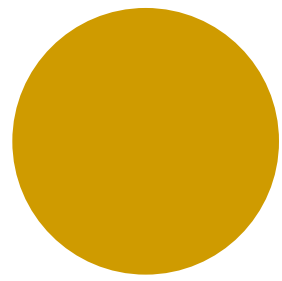

YELLOW
(YL)

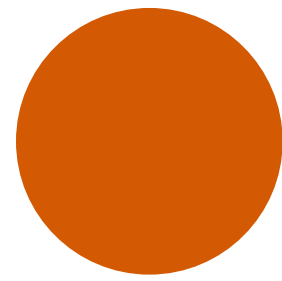

ORANGE
(OR)

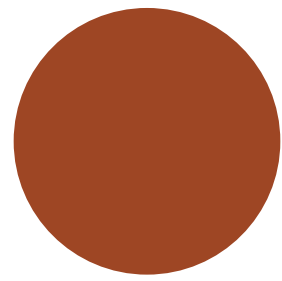

TERRACOTTA
(TC)

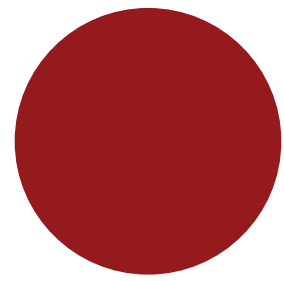

RED
(RD)

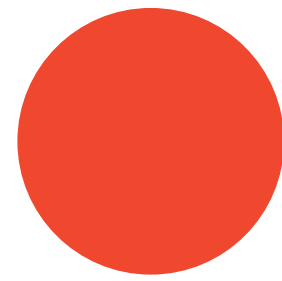

RED ORANGE
(RO)

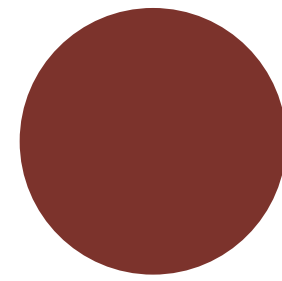

RUSTY RED
(RR)

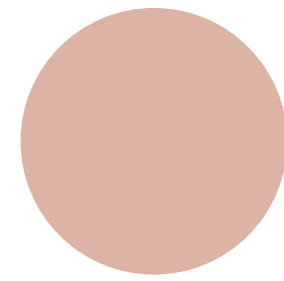

DUSTY PINK
(DP)

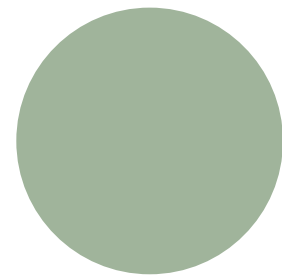

MEADOW GREEN
(MG)

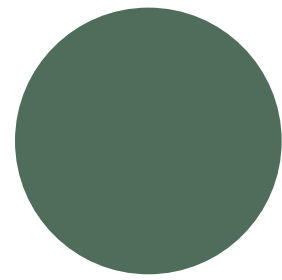

FOREST GREEN
(FG)

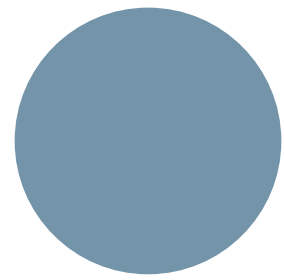

SOFT BLUE
(SB)

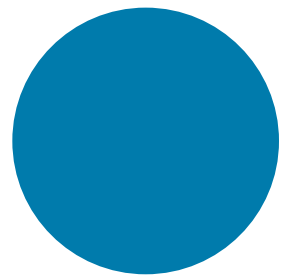

BLUE
(BL)

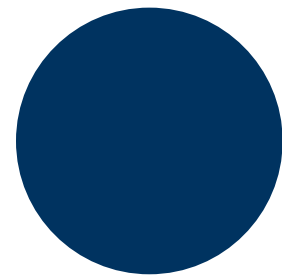

NAVY
(NV)

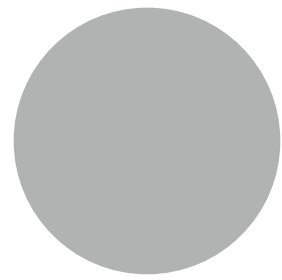

LIGHT GRAY
(LG)



CHAMPAGNE
(CP)

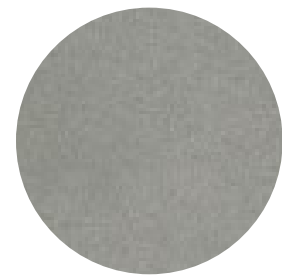

METALLIC SILVER
(MS)

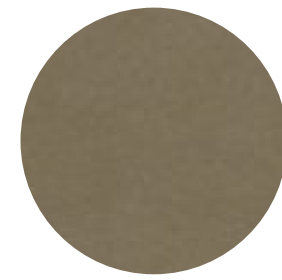

NICKEL
(NK)

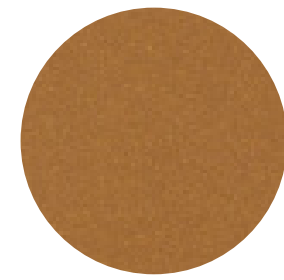

BRASS
(BR)

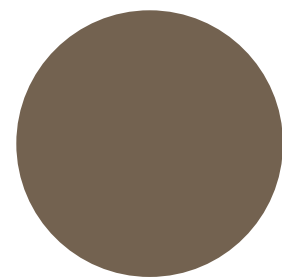

TAUPE
(TP)



DARK BRONZE
(DB)

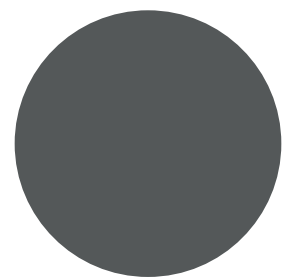

DARK GRAY
(DG)



TEXTURED SLATE
(TS)

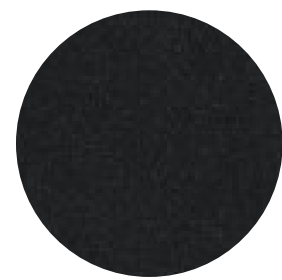

BLACK TWILIGHT
(BT)

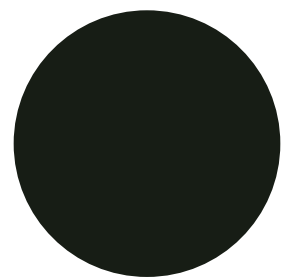

BLACK MATTE
(BM)

MESH COLORS

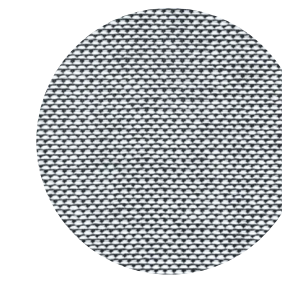

SILVER ICE
(38)

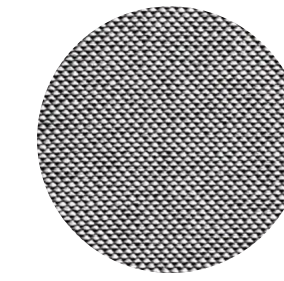

ZINC
(32)

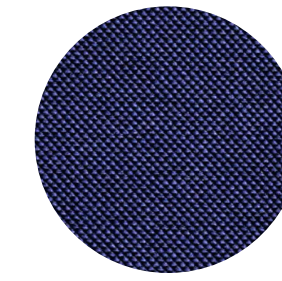

MARINE
(36)

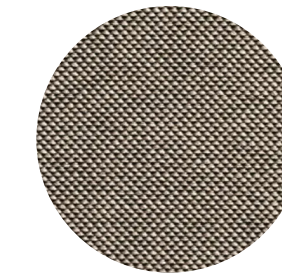

MUSHROOM
(31)

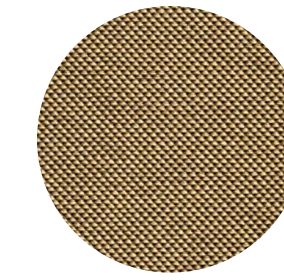

CAMEL
(35)

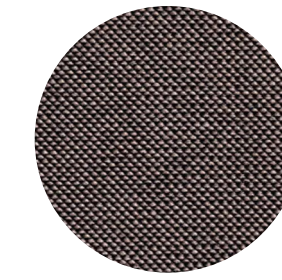

JAVA
(33)

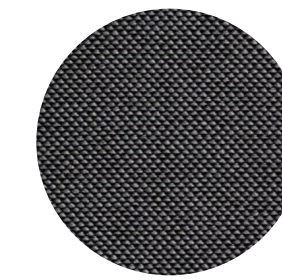

ANTHRACITE
(30)

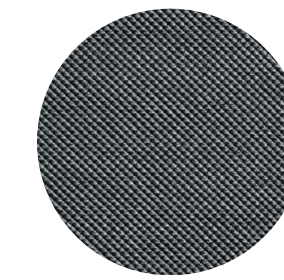

BLACK ICE
(34)



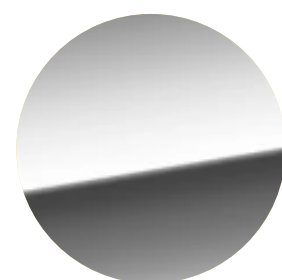

POLISHED ALUMINUM

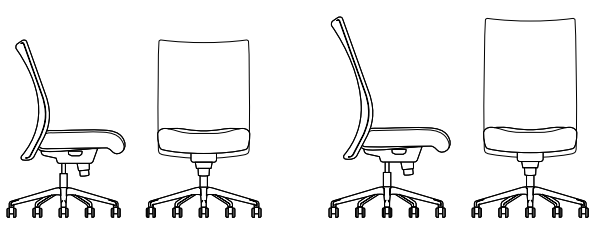
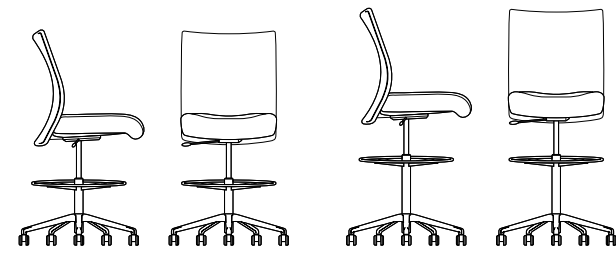
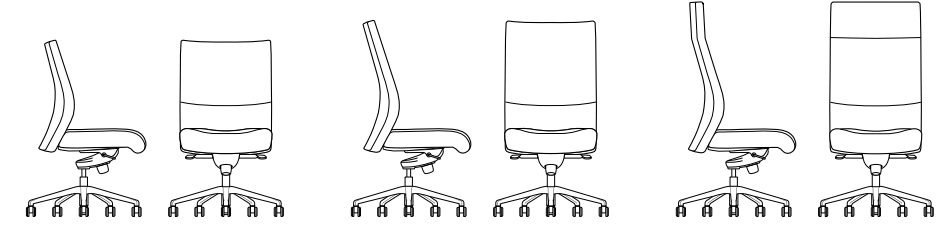
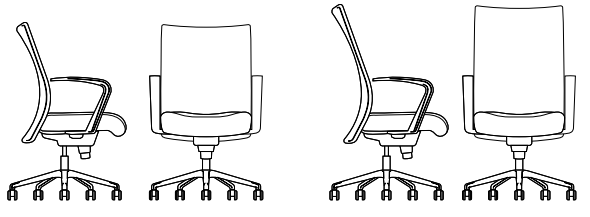
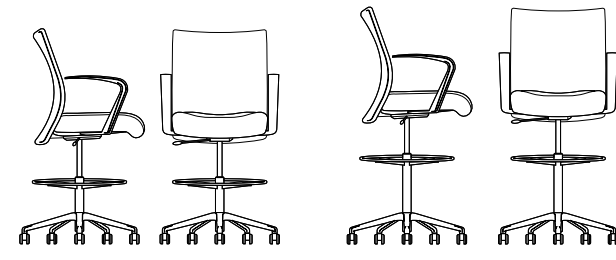

POLISHED
ALUMINUM

Insight

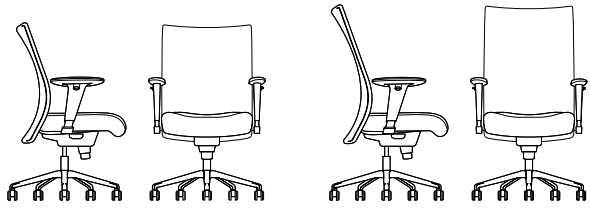
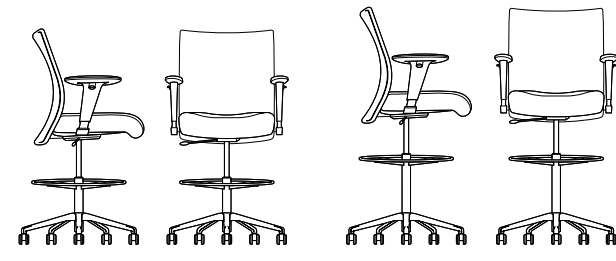
SPECIFICATION GUIDE: STATEMENT OF LINE

OVERVIEW	CHAIR	STOOL	EXECUTIVE CHAIR
Armless	Medium or High Back, Mesh or Upholstered	Counter or Bar Height Medium Back, Mesh or Upholstered	Medium, High, or Tall Back Upholstered
			
Cantilever Fixed Height Arm Black Urethane Powder Coated Aluminum Powder Coated Aluminum w/ Arm Cap Polished Aluminum Polished Aluminum w/ Arm Cap Fully Upholstered	Medium or High Back, Mesh or Upholstered	Counter or Bar Height Medium Back, Mesh or Upholstered	Medium, High, or Tall Back Upholstered
			
Adjustable T-Shape Arm Black w/ Urethane Cap Chrome w/ Urethane Cap	Medium or High Back, Mesh or Upholstered	Counter or Bar Height Medium Back, Mesh or Upholstered	Medium, High, or Tall Back Upholstered
			

OPTION OVERVIEW				
Control Options Center Pivot Tilt (General Environment Chair) Mid Pivot Tilt (Conference Chair) Mid Pivot Synchro Tilt (Variable Task Chair) Basic Swivel (Stools) Seat Slide (Synchro Only) Height Lock	Base Options Black Nylon Cast Aluminum (Polished or Powder Coated)	Caster Options Hard Casters Rubber Tired Casters Glide Substitution	Cantilever Arm Cap Options Black Urethane Upholstered Black Plastic	Miscellaneous Options Contrasting Thread Upholstery Coordinated Upholstery (Seats and Backs) Bumper Guards (Mesh Back Models)

GENERAL INFORMATION
Design Stylex
Back Construction Backs consist of a knit polyester and elastomeric thread mesh sock or upholstered cover with a thin layer of flexible polyurethane foam, pulled over a steel frame. Executive Chair back steel frames are over-molded with flexible polyurethane foam for added comfort.
Seat Construction Seats incorporate compound curve plywood covered with cushions of flexible polyurethane foam.
Arms Height-adjustable arms have pads made from self-skinned black urethane over a steel frame. Fixed height cantilever arms may be exposed or upholstered self-skinned black polyurethane over steel. Aluminum arms may be polished or painted with or without caps. Caps may be upholstered or black plastic.
Bases The black, glass-filled nylon, five-prong base is standard on chair and stool models. The cast aluminum base in highly polished finish or a choice of powder coat finishes, is standard on executive chair models. Any non-standard Insight base can be specified for a model-dependent upcharge or deduction.
Casters Optional rubber tired casters must be used on hard floors such as wood, linoleum or concrete. Please be sure to specify rubber tired casters for these applications.
Use Designed for indoor use only.
Performance Standards Manufactured to comply with: ANSI/BIFMA X5.1 General-Purpose Office Chairs - Tests
Certifications GREENGUARD Gold LEVEL® 1

Insight

SPECIFICATION GUIDE: DIMENSIONS

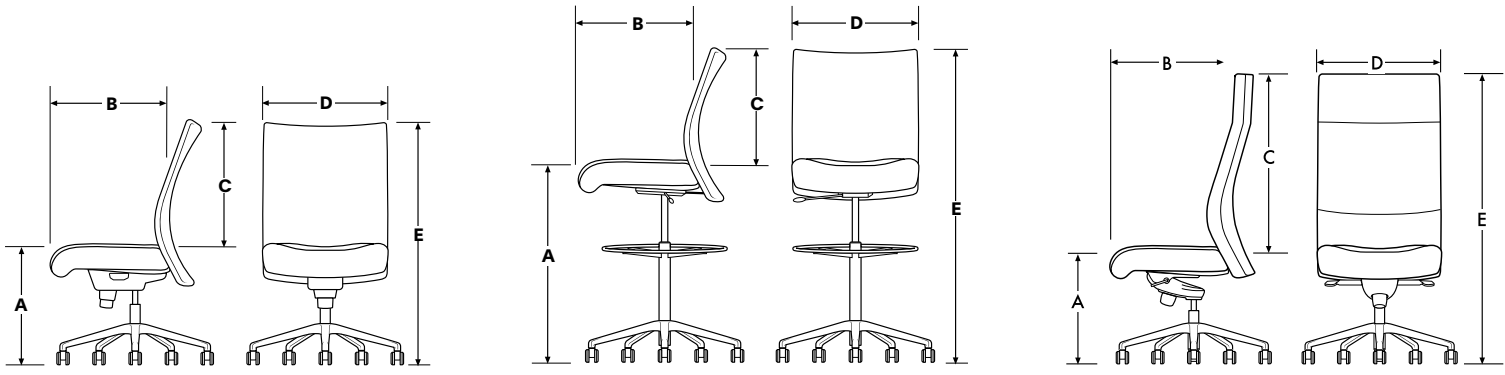
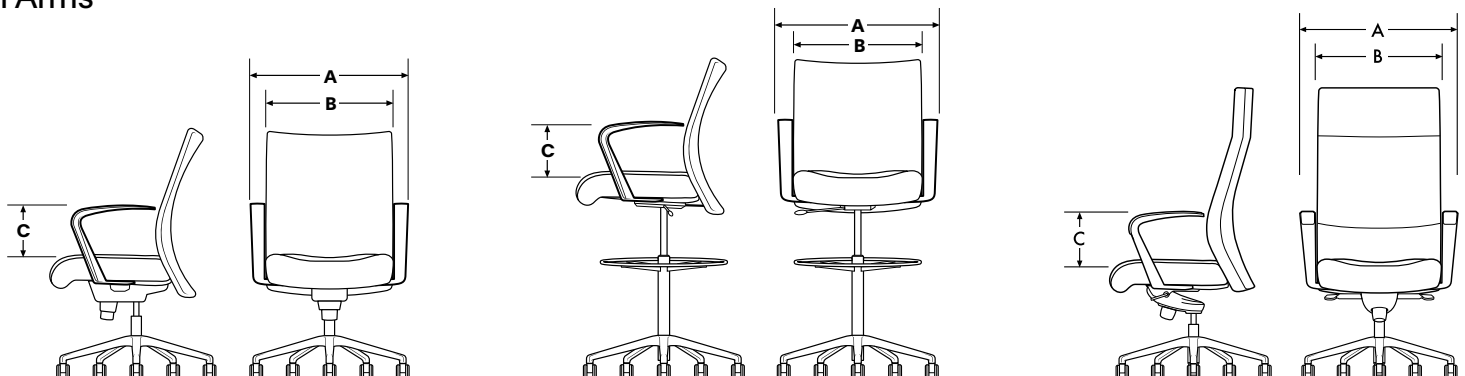
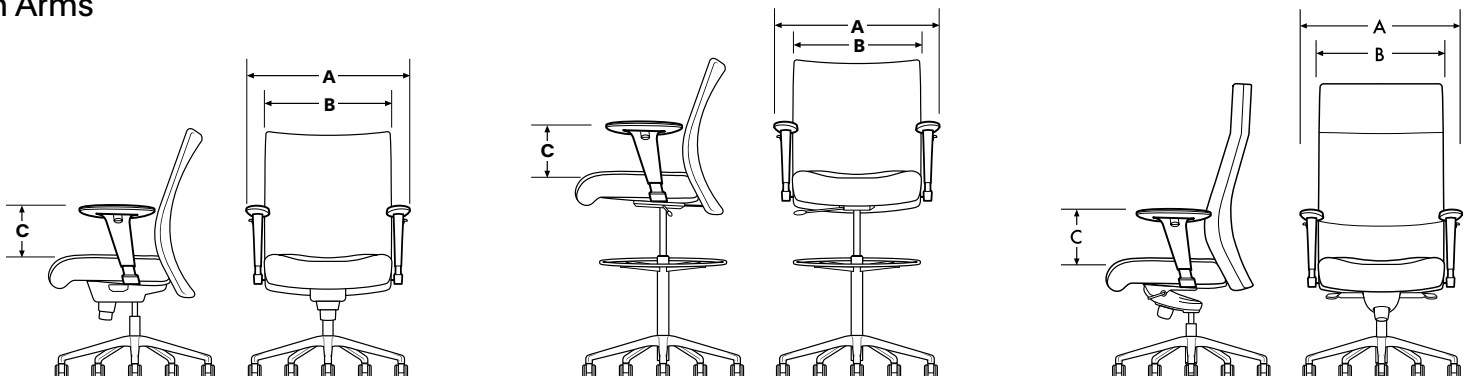
OVERVIEW	CHAIR		STOOL		EXECUTIVE CHAIR		
<p>Dimensions</p> <ul style="list-style-type: none"> A. Seat Height* B. Seat Depth C. Back Height D. Seat Width & Overall Width (Armless) E. Maximum Overall Height <p>* Measurements given are for most controls. Specific models may vary slightly.</p> 	<p>Medium Back</p> <ul style="list-style-type: none"> A. 17-21 B. 18 C. 20 D. 20.5 E. 35.5-39 	<p>High Back</p> <ul style="list-style-type: none"> A. 17-21 B. 18 C. 24 D. 20.5 E. 39-42.5 	<p>Counter Height</p> <ul style="list-style-type: none"> A. 20.5-28.5 B. 18 C. 18 D. 20.5 E. 46.5 	<p>Bar Height</p> <ul style="list-style-type: none"> A. 23.5-33.5 B. 18 C. 18 D. 20.5 E. 51.5 	<p>Medium Back</p> <ul style="list-style-type: none"> A. 17.5-21 B. 19 C. 20.5 D. 20.5 E. 37.75-41.5 	<p>High Back</p> <ul style="list-style-type: none"> A. 17.25-21 B. 19 C. 24 D. 20.5 E. 41.25-45.5 	<p>Tall Back</p> <ul style="list-style-type: none"> A. 17.25-21 B. 19 C. 28 D. 20.5 E. 45.25-49
<p>Cantilevered Fixed Arm Choice</p> <ul style="list-style-type: none"> A. Overall Width B. Distance Between Arms C. Arm Height 	<p>Chair</p> <ul style="list-style-type: none"> A. 25 B. 21 C. 8.5 		<p>Stool</p> <ul style="list-style-type: none"> A. 25 B. 21 C. 8.5 		<p>Executive Chair</p> <ul style="list-style-type: none"> A. 25 B. 21 C. 8.5 		
<p>Cantilevered Fixed Arm Choice</p> <ul style="list-style-type: none"> A. Overall Width B. Distance Between Arms C. Arm Height 	<p>Chair</p> <ul style="list-style-type: none"> A. 26 B. 19 C. 6.5-9.5 		<p>Stool</p> <ul style="list-style-type: none"> A. 26 B. 19 C. 6.5-9.5 		<p>Executive Chair</p> <ul style="list-style-type: none"> A. 25 B. 19 C. 6.5-9.5 		

Insight

SPECIFICATION GUIDE: HOW TO ORDER

MODEL CODE BREAKDOWN

Sample Model Code: IN16105930CTRBLCOM



IN **1** **6** **10** **59** **30** **CT R** **BL** **COM**

Series	Style	Back	Control	Armless	Fixed Height C-Arm	Adjustable Height Arm	Mesh	Options	Standard Powder Coated Metal	Textile Grades	Leather Grades
IN INSIGHT	1 MESH 2 UPHOLSTERED 4 EXECUTIVE	5 MEDIUM STOOL 6 MEDIUM 8 HIGH 9 TALL	10 CENTER PIVOT TILT 16 MID PIVOT TILT 27 MID PIVOT SYNCHRO TILT 38 EXECUTIVE FORWARD PIVOT KNEE TILT 61 BASIC SWIVEL	00 ARMLESS	51 BLACK URETHANE 54 PAINTED, NO ARM CAP 55 PAINTED, PLASTIC ARM CAP 56 PAINTED, UPHOLSTERED ARM CAP 57 FULLY UPHOLSTERED 64 POLISHED, NO ARM CAP 65 POLISHED, PLASTIC ARM CAP 66 POLISHED, UPHOLSTERED ARM CAP	59 BLACK 69 CHROME	30 ANTHRACITE 31 MUSHROOM 32 ZINC 33 JAVA 34 BLACK ICE 35 CAMEL 36 MARINE 38 SILVER ICE	B10 PLASTIC BASE B22 PAINTED ALUMINUM BASE B23 POLISHED ALUMINUM BASE BG BUMPER GUARDS CT CONTRASTING THREAD CU COORDINATED UPHOLSTERY GL GLIDE SUBSTITUTION R RUBBER TIRED CASTERS SS SEAT SLIDE HL HEIGHT LOCK	BL BLUE BM BLACK MATTE BR BRASS BT BLACK TWILIGHT CP CHAMPAGNE DB DARK BRONZE DG DARK GRAY DP DUSTY PINK FG FOREST GREEN LG LIGHT GRAY MG MEADOW GREEN MK MILK MS METALLIC SILVER NK NICKEL NV NAVY OR ORANGE PY PALE YELLOW RD RED RO RED ORANGE RR RUSTY RED SB SOFT BLUE SD SAND TC TERRACOTTA TP TAUPE TS TEXTURED SLATE YL YELLOW	COM CUSTOMER'S OWN MATERIAL A GRADE A B GRADE B C GRADE C D GRADE D E GRADE E F GRADE F G GRADE G H GRADE H I GRADE I J GRADE J K GRADE K L GRADE L M GRADE M	COL CUSTOMER'S OWN LEATHER W GRADE W X GRADE X Y GRADE Y E1 GRADE E1 E2 GRADE E2

COMs, COLs and in-graded textiles must be approved specifically for upholstered arm caps.

Powder Coated Metal finish selection will be applied to the aluminum base and/or arms per the model codes. Polished arms can be ordered with a painted base or vice-versa by designating one component for painted finish and the other as polished.

Insight

CHAIR: MESH BACK, CENTER PIVOT TILT

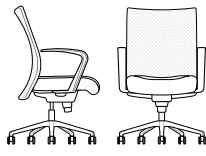
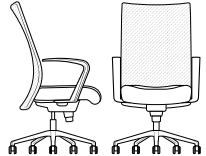
TITLE	BACK	CTRL	ARM	DIMENSIONS	YDG	SF	Textile										Leather										
							COM	COL	COM	COL				COL		W	X	Y	E1	E2							
Medium Back, Mesh Back, Center Pivot Tilt 	Armless	IN16	10	00	20.5W x 27.8D x 35.5-39H	0.75	10	841	878	914	951	984	1,023	1,065	1,108	1,152	1,205	1,280	1,343	1,404	914	1,050	1,099	1,335	1,385	1,598	
	C-Arm, Black Urethane	IN16	10	51	25W x 27.8D x 35.5-39H	0.75	10	1,055	1,092	1,128	1,165	1,198	1,237	1,279	1,322	1,366	1,419	1,494	1,557	1,618	1,128	1,264	1,313	1,549	1,599	1,812	
	C-Arm, Painted, No Arm Cap	IN16	10	54/64	25W x 27.8D x 35.5-39H	0.75	10	1,225	1,262	1,298	1,335	1,368	1,407	1,449	1,492	1,536	1,589	1,664	1,727	1,788	1,298	1,434	1,483	1,719	1,769	1,982	
	C-Arm, Painted, Plastic Arm Cap	IN16	10	55/65	25W x 27.8D x 35.5-39H	0.75	10	1,262	1,299	1,335	1,372	1,405	1,444	1,486	1,529	1,573	1,626	1,701	1,764	1,825	1,335	1,471	1,520	1,756	1,806	2,019	
	C-Arm, Painted, Uph Arm Cap	IN16	10	56/66	25W x 27.8D x 35.5-39H	0.75	10	1,301	1,338	1,374	1,411	1,444	1,483	1,525	1,568	1,612	1,665	1,740	1,803	1,864	1,374	1,510	1,559	1,795	1,845	2,058	
	C-Arm, Fully Uph	IN16	10	57	25W x 27.8D x 35.5-39H	-	21	-	-	-	-	-	-	-	-	-	-	-	-	-	-	1,502	1,763	1,852	2,442	2,588	3,016
	Arm, Adjustable Height, Black	IN16	10	59	26W x 27.8D x 35.5-39H	0.75	10	1,055	1,092	1,128	1,165	1,198	1,237	1,279	1,322	1,366	1,419	1,494	1,557	1,618	1,128	1,264	1,313	1,549	1,599	1,812	
	Arm, Adjustable Height, Chrome	IN16	10	69	26W x 27.8D x 35.5-39H	0.75	10	1,071	1,108	1,144	1,181	1,214	1,253	1,295	1,338	1,382	1,435	1,510	1,573	1,634	1,144	1,280	1,329	1,565	1,615	1,828	
High Back, Mesh Back, Center Pivot Tilt 	Armless	IN18	10	00	20.5W x 27.8D x 39-42.5H	0.75	10	895	933	967	1,006	1,043	1,078	1,116	1,162	1,208	1,260	1,335	1,398	1,459	967	1,105	1,151	1,391	1,436	1,653	
	C-Arm, Black Urethane	IN18	10	51	25W x 27.8D x 39-42.5H	0.75	10	1,109	1,147	1,181	1,220	1,257	1,292	1,330	1,376	1,422	1,474	1,549	1,612	1,673	1,181	1,319	1,365	1,605	1,650	1,867	
	C-Arm, Painted, No Arm Cap	IN18	10	54/64	25W x 27.8D x 39-42.5H	0.75	10	1,279	1,317	1,351	1,390	1,427	1,462	1,500	1,546	1,592	1,644	1,719	1,782	1,843	1,351	1,489	1,535	1,775	1,820	2,037	
	C-Arm, Painted, Plastic Arm Cap	IN18	10	55/65	25W x 27.8D x 39-42.5H	0.75	10	1,316	1,354	1,388	1,427	1,464	1,499	1,537	1,583	1,629	1,681	1,756	1,819	1,880	1,388	1,526	1,572	1,812	1,857	2,074	
	C-Arm, Painted, Uph Arm Cap	IN18	10	56/66	25W x 27.8D x 39-42.5H	0.75	10	1,355	1,393	1,427	1,466	1,503	1,538	1,576	1,622	1,668	1,720	1,795	1,858	1,919	1,427	1,565	1,611	1,851	1,896	2,113	
	C-Arm, Fully Uph	IN18	10	57	25W x 27.8D x 39-42.5H	-	21	-	-	-	-	-	-	-	-	-	-	-	-	-	-	1,558	1,712	1,800	2,496	2,638	3,068
	Arm, Adjustable Height, Black	IN18	10	59	26W x 27.8D x 39-42.5H	0.75	10	1,109	1,147	1,181	1,220	1,257	1,292	1,330	1,376	1,422	1,474	1,549	1,612	1,673	1,181	1,319	1,365	1,605	1,650	1,867	
	Arm, Adjustable Height, Chrome	IN18	10	69	26W x 27.8D x 39-42.5H	0.75	10	1,125	1,163	1,197	1,236	1,273	1,308	1,346	1,392	1,438	1,490	1,565	1,628	1,689	1,197	1,335	1,381	1,621	1,666	1,883	

To Order Select Below

1. Series/Back

IN16
Insight Chair Mesh, Medium Back
IN18
Insight Chair Mesh, High Back

Dimensions
Go to [page 7](#) for product dimension details.

2. Control

10	CENTER PIVOT TILT
Adjustments	
Pneumatic Seat Height	
Tilt Tension	
Tilt Lockout	

3. Arm Choice

00	ARMLESS
51	C-ARM, BLACK URETHANE
54	C-ARM, PAINTED, NO ARM CAP
55	C-ARM, PAINTED, PLASTIC ARM CAP
56	C-ARM, PAINTED, UPH ARM CAP
57	C-ARM, FULLY UPH
59	ARM, ADJUSTABLE HEIGHT, BLACK
64	C-ARM, POLISHED, NO ARM CAP
65	C-ARM, POLISHED, PLASTIC ARM CAP
66	C-ARM, POLISHED, UPH ARM CAP
69	ARM, ADJUSTABLE HEIGHT, CHROME



COMs, COLs and in-graded textiles must be approved specifically for upholstered arm caps.

4. Mesh Choice

30	ANTHRACITE
31	MUSHROOM
32	ZINC
33	JAVA
34	BLACK ICE
35	CAMEL
36	MARINE
38	SILVER

5. Options

B22	PAINTED ALUMINUM BASE	+86
B23	POLISHED ALUMINUM BASE	+86
R	BLACK RUBBER TIRED CASTERS	+40
BG	BUMPER GUARDS	+40
CT	CONTRASTING THREAD	
GL	GLIDE SUBSTITUTION	
HL	HEIGHT LOCK	+13

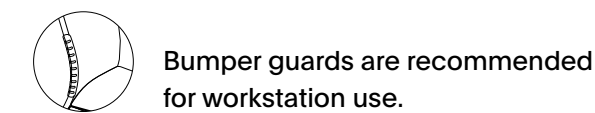

Chair Base Options
If a powder coated cast aluminum or polished cast aluminum base option is not selected, the base choice will be black nylon by default.

Caster Options
Black carpet casters are used on five blade base unless another caster or glide option is chosen.

6. Base Finish

Standard Powder Coated Metal	
BL	BLUE
BM	BLACK MATTE
BR	BRASS
BT	BLACK TWILIGHT
CP	CHAMPAGNE
DB	DARK BRONZE
DG	DARK GRAY
DP	DUSTY PINK
FG	FOREST GREEN
LG	LIGHT GRAY
MG	MEADOW GREEN
MK	MILK
MS	METALLIC SILVER
NK	NICKEL
NV	NAVY
OR	ORANGE
PY	PALE YELLOW
RD	RED
RO	RED ORANGE
RR	RUSTY RED
SB	SOFT BLUE
SD	SAND
TC	TERRACOTTA
TP	TAUPE
TS	TEXTURED SLATE
YL	YELLOW

Powder Coated Metal finish selection will be applied to the aluminum base and/or arms per the model codes. Polished arms can be ordered with a painted base or vice-versa by designating one component for painted finish and the other as polished.

7. Upholstery

See [general information section](#) for details on textile program and COM/COL information.

Insight

CHAIR: MESH BACK, MID PIVOT TILT

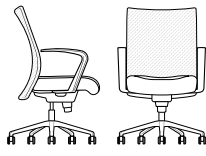
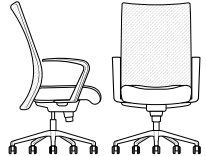
TITLE	BACK	CTRL	ARM	DIMENSIONS	YDG	SF	Textile													Leather							
							COM	COL	COL	A	B	C	D	E	F	G	H	I	J	K	L	M	COL	W	X	Y	E1
Medium Back, Mesh Back, Mid Pivot Tilt 	Armless	IN16	16	00	20.5W x 27.8D x 35.5-39H	0.75	10	949	983	1,020	1,057	1,095	1,134	1,173	1,219	1,262	1,313	1,391	1,455	1,516	1,020	1,159	1,206	1,445	1,491	1,710	
	C-Arm, Black Urethane	IN16	16	51	25W x 27.8D x 35.5-39H	0.75	10	1,163	1,197	1,234	1,271	1,309	1,348	1,387	1,433	1,476	1,527	1,605	1,669	1,730	1,234	1,373	1,420	1,659	1,705	1,924	
	C-Arm, Painted, No Arm Cap	IN16	16	54/64	25W x 27.8D x 35.5-39H	0.75	10	1,333	1,367	1,404	1,441	1,479	1,518	1,557	1,603	1,646	1,697	1,775	1,839	1,900	1,404	1,543	1,590	1,829	1,875	2,094	
	C-Arm, Painted, Plastic Arm Cap	IN16	16	55/65	25W x 27.8D x 35.5-39H	0.75	10	1,370	1,404	1,441	1,478	1,516	1,555	1,594	1,640	1,683	1,734	1,812	1,876	1,937	1,441	1,580	1,627	1,866	1,912	2,131	
	C-Arm, Painted, Uph Arm Cap	IN16	16	56/66	25W x 27.8D x 35.5-39H	0.75	10	1,409	1,443	1,480	1,517	1,555	1,594	1,633	1,679	1,722	1,773	1,851	1,915	1,976	1,480	1,619	1,666	1,905	1,951	2,170	
	C-Arm, Fully Uph	IN16	16	57	25W x 27.8D x 35.5-39H	-	21	-	-	-	-	-	-	-	-	-	-	-	-	-	-	1,611	1,868	1,976	2,553	2,691	3,123
	Arm, Adjustable Height, Black	IN16	16	59	26W x 27.8D x 35.5-39H	0.75	10	1,163	1,197	1,234	1,271	1,309	1,348	1,387	1,433	1,476	1,527	1,605	1,669	1,730	1,234	1,373	1,420	1,659	1,705	1,924	
	Arm, Adjustable Height, Chrome	IN16	16	69	26W x 27.8D x 35.5-39H	0.75	10	1,179	1,213	1,250	1,287	1,325	1,364	1,403	1,449	1,492	1,543	1,621	1,685	1,746	1,250	1,389	1,436	1,675	1,721	1,940	
High Back, Mesh Back, Mid Pivot Tilt 	Armless	IN18	16	00	20.5W x 27.8D x 39-42.5H	0.75	10	1,005	1,041	1,076	1,111	1,149	1,185	1,225	1,273	1,316	1,367	1,443	1,506	1,567	1,076	1,214	1,261	1,504	1,546	1,766	
	C-Arm, Black Urethane	IN18	16	51	25W x 27.8D x 39-42.5H	0.75	10	1,219	1,255	1,290	1,325	1,363	1,399	1,439	1,487	1,530	1,581	1,657	1,720	1,781	1,290	1,428	1,475	1,718	1,760	1,980	
	C-Arm, Painted, No Arm Cap	IN18	16	54/64	25W x 27.8D x 39-42.5H	0.75	10	1,389	1,425	1,460	1,495	1,533	1,569	1,609	1,657	1,700	1,751	1,827	1,890	1,951	1,460	1,598	1,645	1,888	1,930	2,150	
	C-Arm, Painted, Plastic Arm Cap	IN18	16	55/65	25W x 27.8D x 39-42.5H	0.75	10	1,426	1,462	1,497	1,532	1,570	1,606	1,646	1,694	1,737	1,788	1,864	1,927	1,988	1,497	1,635	1,682	1,925	1,967	2,187	
	C-Arm, Painted, Uph Arm Cap	IN18	16	56/66	25W x 27.8D x 39-42.5H	0.75	10	1,465	1,501	1,536	1,571	1,609	1,645	1,685	1,733	1,776	1,827	1,903	1,966	2,027	1,536	1,674	1,721	1,964	2,006	2,226	
	C-Arm, Fully Uph	IN18	16	57	25W x 27.8D x 39-42.5H	-	21	-	-	-	-	-	-	-	-	-	-	-	-	-	-	1,667	1,959	2,052	2,657	2,797	3,241
	Arm, Adjustable Height, Black	IN18	16	59	26W x 27.8D x 39-42.5H	0.75	10	1,219	1,255	1,290	1,325	1,363	1,399	1,439	1,487	1,530	1,581	1,657	1,720	1,781	1,290	1,428	1,475	1,718	1,760	1,980	
	Arm, Adjustable Height, Chrome	IN18	16	69	26W x 27.8D x 39-42.5H	0.75	10	1,235	1,271	1,306	1,341	1,379	1,415	1,455	1,503	1,546	1,597	1,673	1,736	1,797	1,306	1,444	1,491	1,734	1,776	1,996	

To Order Select Below

1. Series/Back

IN16
Insight Chair Mesh, Medium Back
IN18
Insight Chair Mesh, High Back

Dimensions
Go to [page 7](#) for product dimension details.

2. Control

16	MID PIVOT TILT
Adjustments	
Pneumatic Seat Height	
Tilt Tension	
Tilt Lockout	

3. Arm Choice

00	ARMLESS
51	C-ARM, BLACK URETHANE
54	C-ARM, PAINTED, NO ARM CAP
55	C-ARM, PAINTED, PLASTIC ARM CAP
56	C-ARM, PAINTED, UPH ARM CAP
57	C-ARM, FULLY UPH
59	ARM, ADJUSTABLE HEIGHT, BLACK
64	C-ARM, POLISHED, NO ARM CAP
65	C-ARM, POLISHED, PLASTIC ARM CAP
66	C-ARM, POLISHED, UPH ARM CAP
69	ARM, ADJUSTABLE HEIGHT, CHROME

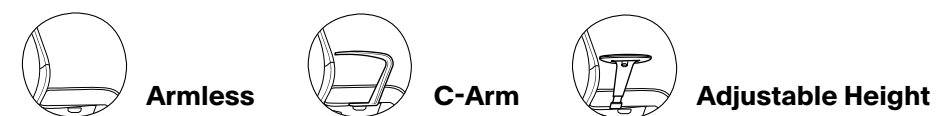

COMs, COLs and in-graded textiles must be approved specifically for upholstered arm caps.

4. Mesh Choice

30	ANTHRACITE
31	MUSHROOM
32	ZINC
33	JAVA
34	BLACK ICE
35	CAMEL
36	MARINE
38	SILVER

5. Options

B22	PAINTED ALUMINUM BASE	+86
B23	POLISHED ALUMINUM BASE	+86
R	BLACK RUBBER TIRED CASTERS	+40
BG	BUMPER GUARDS	+40
CT	CONTRASTING THREAD	
GL	GLIDE SUBSTITUTION	
HL	HEIGHT LOCK	+13

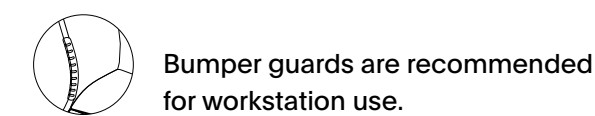

Chair Base Options
If a powder coated cast aluminum or polished cast aluminum base option is not selected, the base choice will be black nylon by default.

Caster Options
Black carpet casters are used on five blade base unless another caster or glide option is chosen.

6. Base Finish

Standard Powder Coated Metal			
BL	BLUE	NK	NICKEL
BM	BLACK MATTE	NV	NAVY
BR	BRASS	OR	ORANGE
BT	BLACK TWILIGHT	PY	PALE YELLOW
CP	CHAMPAGNE	RD	RED
DB	DARK BRONZE	RO	RED ORANGE
DG	DARK GRAY	RR	RUSTY RED
DP	DUSTY PINK	SB	SOFT BLUE
FG	FOREST GREEN	SD	SAND
LG	LIGHT GRAY	TC	TERRACOTTA
MG	MEADOW GREEN	TP	TAUPE
MK	MILK	TS	TEXTURED SLATE
MS	METALLIC SILVER	YL	YELLOW

Powder Coated Metal finish selection will be applied to the aluminum base and/or arms per the model codes. Polished arms can be ordered with a painted base or vice-versa by designating one component for painted finish and the other as polished.

7. Upholstery

See [general information section](#) for details on textile program and COM/COL information.

Insight

CHAIR: MESH BACK, MID PIVOT SYNCHRO TILT

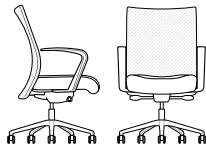
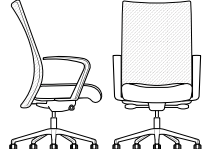
TITLE	BACK	CTRL	ARM	DIMENSIONS	YDG	SF	Textile										Leather										
							COM	COL	COM	COL				COL		W	X	Y	E1	E2							
Medium Back, Mesh Back, Mid Pivot Synchro Tilt 	Armless	IN16	27	00	20.5W x 27.8D x 35.5-39H	0.75	10	1,055	1,093	1,131	1,164	1,204	1,239	1,279	1,328	1,371	1,421	1,499	1,563	1,624	1,131	1,267	1,315	1,559	1,599	1,820	
	C-Arm, Black Urethane	IN16	27	51	25W x 27.8D x 35.5-39H	0.75	10	1,269	1,307	1,345	1,378	1,418	1,453	1,493	1,542	1,585	1,635	1,713	1,777	1,838	1,345	1,481	1,529	1,773	1,813	2,034	
	C-Arm, Painted, No Arm Cap	IN16	27	54/64	25W x 27.8D x 35.5-39H	0.75	10	1,439	1,477	1,515	1,548	1,588	1,623	1,663	1,712	1,755	1,805	1,883	1,947	2,008	1,515	1,651	1,699	1,943	1,983	2,204	
	C-Arm, Painted, Plastic Arm Cap	IN16	27	55/65	25W x 27.8D x 35.5-39H	0.75	10	1,476	1,514	1,552	1,585	1,625	1,660	1,700	1,749	1,792	1,842	1,920	1,984	2,045	1,552	1,688	1,736	1,980	2,020	2,241	
	C-Arm, Painted, Uph Arm Cap	IN16	27	56/66	25W x 27.8D x 35.5-39H	0.75	10	1,515	1,553	1,591	1,624	1,664	1,699	1,739	1,788	1,831	1,881	1,959	2,023	2,084	1,591	1,727	1,775	2,019	2,059	2,280	
	C-Arm, Fully Uph	IN16	27	57	25W x 27.8D x 35.5-39H	-	21	-	-	-	-	-	-	-	-	-	-	-	-	-	-	1,718	2,014	2,103	2,710	2,849	3,293
	Arm, Adjustable Height, Black	IN16	27	59	26W x 27.8D x 35.5-39H	0.75	10	1,269	1,307	1,345	1,378	1,418	1,453	1,493	1,542	1,585	1,635	1,713	1,777	1,838	1,345	1,481	1,529	1,773	1,813	2,034	
	Arm, Adjustable Height, Chrome	IN16	27	69	26W x 27.8D x 35.5-39H	0.75	10	1,285	1,323	1,361	1,394	1,434	1,469	1,509	1,558	1,601	1,651	1,729	1,793	1,854	1,361	1,497	1,545	1,789	1,829	2,050	
High Back, Mesh Back, Mid Pivot Synchro Tilt 	Armless	IN18	27	00	20.5W x 27.8D x 39-42.5H	0.75	10	1,109	1,148	1,182	1,222	1,259	1,295	1,334	1,379	1,424	1,474	1,552	1,615	1,676	1,182	1,320	1,369	1,616	1,654	1,880	
	C-Arm, Black Urethane	IN18	27	51	25W x 27.8D x 39-42.5H	0.75	10	1,323	1,362	1,396	1,436	1,473	1,509	1,548	1,593	1,638	1,688	1,766	1,829	1,890	1,396	1,534	1,583	1,830	1,868	2,094	
	C-Arm, Painted, No Arm Cap	IN18	27	54/64	25W x 27.8D x 39-42.5H	0.75	10	1,493	1,532	1,566	1,606	1,643	1,679	1,718	1,763	1,808	1,858	1,936	1,999	2,060	1,566	1,704	1,753	2,000	2,038	2,264	
	C-Arm, Painted, Plastic Arm Cap	IN18	27	55/65	25W x 27.8D x 39-42.5H	0.75	10	1,530	1,569	1,603	1,643	1,680	1,716	1,755	1,800	1,845	1,895	1,973	2,036	2,097	1,603	1,741	1,790	2,037	2,075	2,301	
	C-Arm, Painted, Uph Arm Cap	IN18	27	56/66	25W x 27.8D x 39-42.5H	0.75	10	1,569	1,608	1,642	1,682	1,719	1,755	1,794	1,839	1,884	1,934	2,012	2,075	2,136	1,642	1,780	1,829	2,076	2,114	2,340	
	C-Arm, Fully Uph	IN18	27	57	25W x 27.8D x 39-42.5H	-	21	-	-	-	-	-	-	-	-	-	-	-	-	-	-	1,773	2,066	2,159	2,768	2,902	3,351
	Arm, Adjustable Height, Black	IN18	27	59	26W x 27.8D x 39-42.5H	0.75	10	1,323	1,362	1,396	1,436	1,473	1,509	1,548	1,593	1,638	1,688	1,766	1,829	1,890	1,396	1,534	1,583	1,830	1,868	2,094	
	Arm, Adjustable Height, Chrome	IN18	27	69	26W x 27.8D x 39-42.5H	0.75	10	1,339	1,378	1,412	1,452	1,489	1,525	1,564	1,609	1,654	1,704	1,782	1,845	1,906	1,412	1,550	1,599	1,846	1,884	2,110	

To Order Select Below

1. Series/Back

IN16
Insight Chair Mesh, Medium Back

IN18
Insight Chair Mesh, High Back

Dimensions
Go to [page 7](#) for product dimension details.



2. Control

27 MID PIVOT SYNCHRO TILT

Adjustments
Pneumatic Seat Height
Back Angle
Tilt Tension
Optional Seat Slide

3. Arm Choice

00 ARMLESS
51 C-ARM, BLACK URETHANE
54 C-ARM, PAINTED, NO ARM CAP
55 C-ARM, PAINTED, PLASTIC ARM CAP
56 C-ARM, PAINTED, UPH ARM CAP
57 C-ARM, FULLY UPH
59 ARM, ADJUSTABLE HEIGHT, BLACK
64 C-ARM, POLISHED, NO ARM CAP
65 C-ARM, POLISHED, PLASTIC ARM CAP
66 C-ARM, POLISHED, UPH ARM CAP
69 ARM, ADJUSTABLE HEIGHT, CHROME

 **Armless**  **C-Arm**  **Adjustable Height**

COMs, COLs and in-graded textiles must be approved specifically for upholstered arm caps.

4. Mesh Choice

30 ANTHRACITE
31 MUSHROOM
32 ZINC
33 JAVA
34 BLACK ICE
35 CAMEL
36 MARINE
38 SILVER

5. Options

B22 PAINTED ALUMINUM BASE **+86**
B23 POLISHED ALUMINUM BASE **+86**
R BLACK RUBBER TIRED CASTERS **+40**
BG BUMPER GUARDS **+40**
CT CONTRASTING THREAD
GL GLIDE SUBSTITUTION
SS SEAT SLIDE **+113**
HL HEIGHT LOCK **+13**

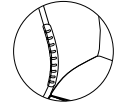
 Bumper guards are recommended for workstation use.

Chair Base Options
If a powder coated cast aluminum or polished cast aluminum base option is not selected, the base choice will be black nylon by default.

Caster Options
Black carpet casters are used on five blade base unless another caster or glide option is chosen.

6. Base Finish

Standard Powder Coated Metal

BL BLUE	NK NICKEL
BM BLACK MATTE	NV NAVY
BR BRASS	OR ORANGE
BT BLACK TWILIGHT	PY PALE YELLOW
CP CHAMPAGNE	RD RED
DB DARK BRONZE	RO RED ORANGE
DG DARK GRAY	RR RUSTY RED
DP DUSTY PINK	SB SOFT BLUE
FG FOREST GREEN	SD SAND
LG LIGHT GRAY	TC TERRACOTTA
MG MEADOW GREEN	TP TAUPE
MK MILK	TS TEXTURED SLATE
MS METALLIC SILVER	YL YELLOW

Powder Coated Metal finish selection will be applied to the aluminum base and/or arms per the model codes. Polished arms can be ordered with a painted base or vice-versa by designating one component for painted finish and the other as polished.

7. Upholstery

See [general information section](#) for details on textile program and COM/COL information.

Insight

CHAIR: UPH BACK, CENTER PIVOT TILT

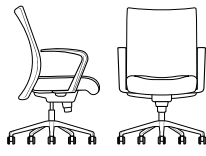
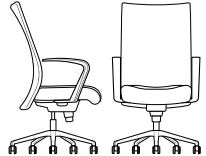
TITLE	BACK	CTRL	ARM	DIMENSIONS	YDG	SF	Textile					Leather															
							COM	COL	COM	COL				COM	COL	COM	COL										
							A	B	C	D	E	F	G	H	I	J	K	L	M	COL	W	X	Y	E1	E2		
Medium Back, Uph Back, Center Pivot Tilt 	Armless	IN26	10	00	20.5W x 27.8D x 35.5-39H	1.6	28	1,025	1,105	1,181	1,259	1,337	1,419	1,499	1,598	1,695	1,804	1,967	2,102	2,233	1,181	1,668	1,800	2,329	2,594	3,116	
	C-Arm, Black Urethane	IN26	10	51	25W x 27.8D x 35.5-39H	1.6	28	1,239	1,319	1,395	1,473	1,551	1,633	1,713	1,812	1,909	2,018	2,181	2,316	2,447	1,395	1,882	2,014	2,543	2,808	3,330	
	C-Arm, Painted, No Arm Cap	IN26	10	54/64	25W x 27.8D x 35.5-39H	1.6	28	1,409	1,489	1,565	1,643	1,721	1,803	1,883	1,982	2,079	2,188	2,351	2,486	2,617	1,565	2,052	2,184	2,713	2,978	3,500	
	C-Arm, Painted, Plastic Arm Cap	IN26	10	55/65	25W x 27.8D x 35.5-39H	1.6	28	1,446	1,526	1,602	1,680	1,758	1,840	1,920	2,019	2,116	2,225	2,388	2,523	2,654	1,602	2,089	2,221	2,750	3,015	3,537	
	C-Arm, Painted, Uph Arm Cap	IN26	10	56/66	25W x 27.8D x 35.5-39H	1.6	28	1,485	1,565	1,641	1,719	1,797	1,879	1,959	2,058	2,155	2,264	2,427	2,562	2,693	1,641	2,128	2,260	2,789	3,054	3,576	
	C-Arm, Fully Uph	IN26	10	57	25W x 27.8D x 35.5-39H	-	39	-	-	-	-	-	-	-	-	-	-	-	-	-	-	1,761	2,414	2,586	3,555	3,913	4,665
	Arm, Adjustable Height, Black	IN26	10	59	26W x 27.8D x 35.5-39H	1.6	28	1,239	1,319	1,395	1,473	1,551	1,633	1,713	1,812	1,909	2,018	2,181	2,316	2,447	1,395	1,882	2,014	2,543	2,808	3,330	
	Arm, Adjustable Height, Chrome	IN26	10	69	26W x 27.8D x 35.5-39H	1.6	28	1,255	1,335	1,411	1,489	1,567	1,649	1,729	1,828	1,925	2,034	2,197	2,332	2,463	1,411	1,898	2,030	2,559	2,824	3,346	
High Back, Uph Back, Center Pivot Tilt 	Armless	IN28	10	00	20.5W x 27.8D x 39-42.5H	1.8	30	1,066	1,152	1,238	1,328	1,415	1,505	1,598	1,712	1,817	1,940	2,124	2,276	2,423	1,238	1,760	1,905	2,443	2,721	3,278	
	C-Arm, Black Urethane	IN28	10	51	25W x 27.8D x 39-42.5H	1.8	30	1,280	1,366	1,452	1,542	1,629	1,719	1,812	1,926	2,031	2,154	2,338	2,490	2,637	1,452	1,974	2,119	2,657	2,935	3,492	
	C-Arm, Painted, No Arm Cap	IN28	10	54/64	25W x 27.8D x 39-42.5H	1.8	30	1,450	1,536	1,622	1,712	1,799	1,889	1,982	2,096	2,201	2,324	2,508	2,660	2,807	1,622	2,144	2,289	2,827	3,105	3,662	
	C-Arm, Painted, Plastic Arm Cap	IN28	10	55/65	25W x 27.8D x 39-42.5H	1.8	30	1,487	1,573	1,659	1,749	1,836	1,926	2,019	2,133	2,238	2,361	2,545	2,697	2,844	1,659	2,181	2,326	2,864	3,142	3,699	
	C-Arm, Painted, Uph Arm Cap	IN28	10	56/66	25W x 27.8D x 39-42.5H	1.8	30	1,526	1,612	1,698	1,788	1,875	1,965	2,058	2,172	2,277	2,400	2,584	2,736	2,883	1,698	2,220	2,365	2,903	3,181	3,738	
	C-Arm, Fully Uph	IN28	10	57	25W x 27.8D x 39-42.5H	-	41	-	-	-	-	-	-	-	-	-	-	-	-	-	-	1,818	2,506	2,694	3,689	4,059	4,845
	Arm, Adjustable Height, Black	IN28	10	59	26W x 27.8D x 39-42.5H	1.8	30	1,280	1,366	1,452	1,542	1,629	1,719	1,812	1,926	2,031	2,154	2,338	2,490	2,637	1,452	1,974	2,119	2,657	2,935	3,492	
	Arm, Adjustable Height, Chrome	IN28	10	69	26W x 27.8D x 39-42.5H	1.8	30	1,296	1,382	1,468	1,558	1,645	1,735	1,828	1,942	2,047	2,170	2,354	2,506	2,653	1,468	1,990	2,135	2,673	2,951	3,508	

To Order Select Below

1. Series/Back

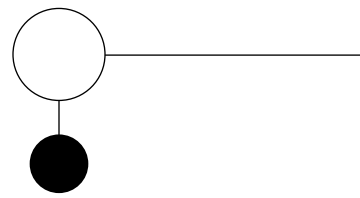

IN26

Insight Chair Upholstered, Medium Back

IN28

Insight Chair Upholstered, High Back

Dimensions
Go to [page 7](#) for product dimension details.

2. Control

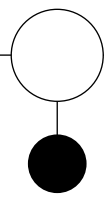

Control

10 CENTER PIVOT TILT

Adjustments
Pneumatic Seat Height
Tilt Tension
Tilt Lockout

3. Arm Choice

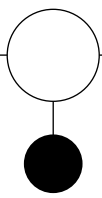

Arm Choice

- 00 ARMLESS
- 51 C-ARM, BLACK URETHANE
- 54 C-ARM, PAINTED, NO ARM CAP
- 55 C-ARM, PAINTED, PLASTIC ARM CAP
- 56 C-ARM, PAINTED, UPH ARM CAP
- 57 C-ARM, FULLY UPH
- 59 ARM, ADJUSTABLE HEIGHT, BLACK
- 64 C-ARM, POLISHED, NO ARM CAP
- 65 C-ARM, POLISHED, PLASTIC ARM CAP
- 66 C-ARM, POLISHED, UPH ARM CAP
- 69 ARM, ADJUSTABLE HEIGHT, CHROME

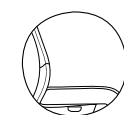

Armless



C-Arm



Adjustable Height

COMs, COLs and in-graded textiles must be approved specifically for upholstered arm caps.

4. Options

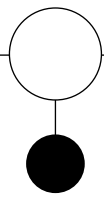

Options

- B22 PAINTED ALUMINUM BASE **+86**
- B23 POLISHED ALUMINUM BASE **+86**
- R BLACK RUBBER TIRED CASTERS **+40**
- CT CONTRASTING THREAD
- GL GLIDE SUBSTITUTION
- CU COORDINATED UPHOLSTERY **+40**
- HL HEIGHT LOCK **+13**

Chair Base Options

If a powder coated cast aluminum or polished cast aluminum base option is not selected, the base choice will be black nylon by default.

Coordinated Upholstery

These chairs may be ordered with coordinated upholstery, as opposed to standard matching upholstery on seats and backs. Please contact customer service for details.

Caster Options

Black carpet casters are used on five blade base unless another caster or glide option is chosen.

5. Base Finish

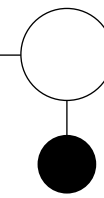

Standard Powder Coated Metal

- BL BLUE
- BM BLACK MATTE
- BR BRASS
- BT BLACK TWILIGHT
- CP CHAMPAGNE
- DB DARK BRONZE
- DG DARK GRAY
- DP DUSTY PINK
- FG FOREST GREEN
- LG LIGHT GRAY
- MG MEADOW GREEN
- MK MILK
- MS METALLIC SILVER
- NK NICKEL
- NV NAVY
- OR ORANGE
- PY PALE YELLOW
- RD RED
- RO RED ORANGE
- RR RUSTY RED
- SB SOFT BLUE
- SD SAND
- TC TERRACOTTA
- TP TAUPE
- TS TEXTURED SLATE
- YL YELLOW

Powder Coated Metal finish selection will be applied to the aluminum base and/or arms per the model codes. Polished arms can be ordered with a painted base or vice-versa by designating one component for painted finish and the other as polished.

6. Upholstery

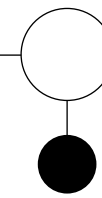

See general information section for details on textile program and COM/COL information.

Insight

CHAIR: UPH BACK, MID PIVOT TILT

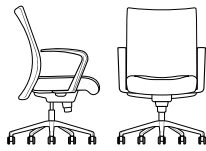
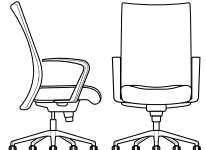
TITLE	BACK	CTRL	ARM	DIMENSIONS	YDG	SF	Textile										Leather										
							COM	COL	COM	COL				COL		W	X	Y	E1	E2							
Medium Back, Uph Back, Mid Pivot Tilt 	Armless	IN26	16	00	20.5W x 27.8D x 35.5-39H	1.6	28	1,135	1,214	1,290	1,365	1,445	1,528	1,607	1,709	1,804	1,911	2,075	2,210	2,340	1,290	1,775	1,905	2,443	2,702	3,231	
	C-Arm, Black Urethane	IN26	16	51	25W x 27.8D x 35.5-39H	1.6	28	1,349	1,428	1,504	1,579	1,659	1,742	1,821	1,923	2,018	2,125	2,289	2,424	2,554	1,504	1,989	2,119	2,657	2,916	3,445	
	C-Arm, Painted, No Arm Cap	IN26	16	54/64	25W x 27.8D x 35.5-39H	1.6	28	1,519	1,598	1,674	1,749	1,829	1,912	1,991	2,093	2,188	2,295	2,459	2,594	2,724	1,674	2,159	2,289	2,827	3,086	3,615	
	C-Arm, Painted, Plastic Arm Cap	IN26	16	55/65	25W x 27.8D x 35.5-39H	1.6	28	1,556	1,635	1,711	1,786	1,866	1,949	2,028	2,130	2,225	2,332	2,496	2,631	2,761	1,711	2,196	2,326	2,864	3,123	3,652	
	C-Arm, Painted, Uph Arm Cap	IN26	16	56/66	25W x 27.8D x 35.5-39H	1.6	28	1,595	1,674	1,750	1,825	1,905	1,988	2,067	2,169	2,264	2,371	2,535	2,670	2,800	1,750	2,235	2,365	2,903	3,162	3,691	
	C-Arm, Fully Uph	IN26	16	57	25W x 27.8D x 35.5-39H	-	39	-	-	-	-	-	-	-	-	-	-	-	-	-	-	1,868	2,521	2,694	3,666	4,016	4,775
	Arm, Adjustable Height, Black	IN26	16	59	26W x 27.8D x 35.5-39H	1.6	28	1,349	1,428	1,504	1,579	1,659	1,742	1,821	1,923	2,018	2,125	2,289	2,424	2,554	1,504	1,989	2,119	2,657	2,916	3,445	
	Arm, Adjustable Height, Chrome	IN26	16	69	26W x 27.8D x 35.5-39H	1.6	28	1,365	1,444	1,520	1,595	1,675	1,758	1,837	1,939	2,034	2,141	2,305	2,440	2,570	1,520	2,005	2,135	2,673	2,932	3,461	
High Back, Uph Back, Mid Pivot Tilt 	Armless	IN28	16	00	20.5W x 27.8D x 39-42.5H	1.8	30	1,174	1,262	1,347	1,433	1,526	1,613	1,709	1,817	1,927	2,048	2,232	2,384	2,531	1,347	1,867	2,014	2,557	2,830	3,393	
	C-Arm, Black Urethane	IN28	16	51	25W x 27.8D x 39-42.5H	1.8	30	1,388	1,476	1,561	1,647	1,740	1,827	1,923	2,031	2,141	2,262	2,446	2,598	2,745	1,561	2,081	2,228	2,771	3,044	3,607	
	C-Arm, Painted, No Arm Cap	IN28	16	54/64	25W x 27.8D x 39-42.5H	1.8	30	1,558	1,646	1,731	1,817	1,910	1,997	2,093	2,201	2,311	2,432	2,616	2,768	2,915	1,731	2,251	2,398	2,941	3,214	3,777	
	C-Arm, Painted, Plastic Arm Cap	IN28	16	55/65	25W x 27.8D x 39-42.5H	1.8	30	1,595	1,683	1,768	1,854	1,947	2,034	2,130	2,238	2,348	2,469	2,653	2,805	2,952	1,768	2,288	2,435	2,978	3,251	3,814	
	C-Arm, Painted, Uph Arm Cap	IN28	16	56/66	25W x 27.8D x 39-42.5H	1.8	30	1,634	1,722	1,807	1,893	1,986	2,073	2,169	2,277	2,387	2,508	2,692	2,844	2,991	1,807	2,327	2,474	3,017	3,290	3,853	
	C-Arm, Fully Uph	IN28	16	57	25W x 27.8D x 39-42.5H	-	41	-	-	-	-	-	-	-	-	-	-	-	-	-	-	1,928	2,613	2,806	3,799	4,166	4,957
	Arm, Adjustable Height, Black	IN28	16	59	26W x 27.8D x 39-42.5H	1.8	30	1,388	1,476	1,561	1,647	1,740	1,827	1,923	2,031	2,141	2,262	2,446	2,598	2,745	1,561	2,081	2,228	2,771	3,044	3,607	
	Arm, Adjustable Height, Chrome	IN28	16	69	26W x 27.8D x 39-42.5H	1.8	30	1,404	1,492	1,577	1,663	1,756	1,843	1,939	2,047	2,157	2,278	2,462	2,614	2,761	1,577	2,097	2,244	2,787	3,060	3,623	

To Order Select Below

1. Series/Back

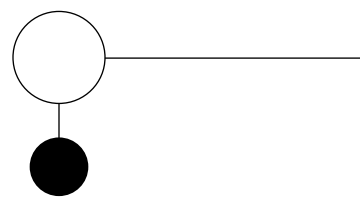

IN26

Insight Chair Upholstered, Medium Back

IN28

Insight Chair Upholstered, High Back

Dimensions

Go to [page 7](#) for product dimension details.

2. Control

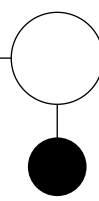

Control

16 MID PIVOT TILT

Adjustments

Pneumatic Seat Height
Tilt Tension
Tilt Lockout

3. Arm Choice

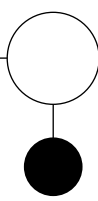

Arm Choice

00 ARMLESS

51 C-ARM, BLACK URETHANE

54 C-ARM, PAINTED, NO ARM CAP

55 C-ARM, PAINTED, PLASTIC ARM CAP

56 C-ARM, PAINTED, UPH ARM CAP

57 C-ARM, FULLY UPH

59 ARM, ADJUSTABLE HEIGHT, BLACK

64 C-ARM, POLISHED, NO ARM CAP

65 C-ARM, POLISHED, PLASTIC ARM CAP

66 C-ARM, POLISHED, UPH ARM CAP

69 ARM, ADJUSTABLE HEIGHT, CHROME

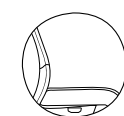

Armless



C-Arm



Adjustable Height

COMs, COLs and in-graded textiles must be approved specifically for upholstered arm caps.

4. Options

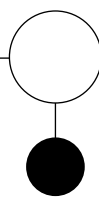

Options

B22 PAINTED ALUMINUM BASE **+86**

B23 POLISHED ALUMINUM BASE **+86**

R BLACK RUBBER TIRED CASTERS **+40**

CT CONTRASTING THREAD

GL GLIDE SUBSTITUTION

CU COORDINATED UPHOLSTERY **+40**

HL HEIGHT LOCK **+13**

Chair Base Options

If a powder coated cast aluminum or polished cast aluminum base option is not selected, the base choice will be black nylon by default.

Coordinated Upholstery

These chairs may be ordered with coordinated upholstery, as opposed to standard matching upholstery on seats and backs. Please contact customer service for details.

Caster Options

Black carpet casters are used on five blade base unless another caster or glide option is chosen.

5. Base Finish

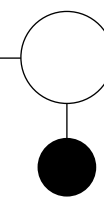

Standard Powder Coated Metal

BL BLUE

BM BLACK MATTE

BR BRASS

BT BLACK TWILIGHT

CP CHAMPAGNE

DB DARK BRONZE

DG DARK GRAY

DP DUSTY PINK

FG FOREST GREEN

LG LIGHT GRAY

MG MEADOW GREEN

MK MILK

MS METALLIC SILVER

NK NICKEL

NV NAVY

OR ORANGE

PY PALE YELLOW

RD RED

RO RED ORANGE

RR RUSTY RED

SB SOFT BLUE

SD SAND

TC TERRACOTTA

TP TAUPE

TS TEXTURED SLATE

YL YELLOW

6. Upholstery

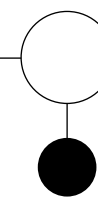

See general information section for details on textile program and COM/COL information.

Powder Coated Metal finish selection will be applied to the aluminum base and/or arms per the model codes. Polished arms can be ordered with a painted base or vice-versa by designating one component for painted finish and the other as polished.

Insight

CHAIR: UPH BACK, MID PIVOT SYNCHRO TILT

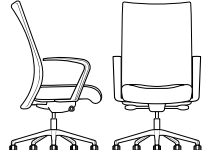
TITLE	BACK	CTRL	ARM	DIMENSIONS	YDG	SF	Textile										Leather										
							COM	COL	COM	COL				COL		W	X	Y	E1	E2							
Medium Back, Uph Back, Mid Pivot Synchro Tilt 	Armless	IN26	27	00	20.5W x 27.8D x 35.5-39H	1.6	28	1,242	1,320	1,399	1,473	1,555	1,634	1,716	1,813	1,911	2,018	2,182	2,316	2,447	1,399	1,883	2,014	2,556	2,810	3,343	
	C-Arm, Black Urethane	IN26	27	51	25W x 27.8D x 35.5-39H	1.6	28	1,456	1,534	1,613	1,687	1,769	1,848	1,930	2,027	2,125	2,232	2,396	2,530	2,661	1,613	2,097	2,228	2,770	3,024	3,557	
	C-Arm, Painted, No Arm Cap	IN26	27	54/64	25W x 27.8D x 35.5-39H	1.6	28	1,626	1,704	1,783	1,857	1,939	2,018	2,100	2,197	2,295	2,402	2,566	2,700	2,831	1,783	2,267	2,398	2,940	3,194	3,727	
	C-Arm, Painted, Plastic Arm Cap	IN26	27	55/65	25W x 27.8D x 35.5-39H	1.6	28	1,663	1,741	1,820	1,894	1,976	2,055	2,137	2,234	2,332	2,439	2,603	2,737	2,868	1,820	2,304	2,435	2,977	3,231	3,764	
	C-Arm, Painted, Uph Arm Cap	IN26	27	56/66	25W x 27.8D x 35.5-39H	1.6	28	1,702	1,780	1,859	1,933	2,015	2,094	2,176	2,273	2,371	2,478	2,642	2,776	2,907	1,859	2,343	2,474	3,016	3,270	3,803	
	C-Arm, Fully Uph	IN26	27	57	25W x 27.8D x 35.5-39H	-	39	-	-	-	-	-	-	-	-	-	-	-	-	-	-	1,976	2,632	2,806	3,777	4,123	4,885
	Arm, Adjustable Height, Black	IN26	27	59	26W x 27.8D x 35.5-39H	1.6	28	1,456	1,534	1,613	1,687	1,769	1,848	1,930	2,027	2,125	2,232	2,396	2,530	2,661	1,613	2,097	2,228	2,770	3,024	3,557	
	Arm, Adjustable Height, Chrome	IN26	27	69	26W x 27.8D x 35.5-39H	1.6	28	1,472	1,550	1,629	1,703	1,785	1,864	1,946	2,043	2,141	2,248	2,412	2,546	2,677	1,629	2,113	2,244	2,786	3,040	3,573	
High Back, Uph Back, Mid Pivot Synchro Tilt 	Armless	IN28	27	00	20.5W x 27.8D x 39-42.5H	1.8	30	1,280	1,371	1,455	1,541	1,632	1,720	1,813	1,927	2,035	2,156	2,340	2,492	2,639	1,455	1,975	2,120	2,670	2,937	3,504	
	C-Arm, Black Urethane	IN28	27	51	25W x 27.8D x 39-42.5H	1.8	30	1,494	1,585	1,669	1,755	1,846	1,934	2,027	2,141	2,249	2,370	2,554	2,706	2,853	1,669	2,189	2,334	2,884	3,151	3,718	
	C-Arm, Painted, No Arm Cap	IN28	27	54/64	25W x 27.8D x 39-42.5H	1.8	30	1,664	1,755	1,839	1,925	2,016	2,104	2,197	2,311	2,419	2,540	2,724	2,876	3,023	1,839	2,359	2,504	3,054	3,321	3,888	
	C-Arm, Painted, Plastic Arm Cap	IN28	27	55/65	25W x 27.8D x 39-42.5H	1.8	30	1,701	1,792	1,876	1,962	2,053	2,141	2,234	2,348	2,456	2,577	2,761	2,913	3,060	1,876	2,396	2,541	3,091	3,358	3,925	
	C-Arm, Painted, Uph Arm Cap	IN28	27	56/66	25W x 27.8D x 39-42.5H	1.8	30	1,740	1,831	1,915	2,001	2,092	2,180	2,273	2,387	2,495	2,616	2,800	2,952	3,099	1,915	2,435	2,580	3,130	3,397	3,964	
	C-Arm, Fully Uph	IN28	27	57	25W x 27.8D x 39-42.5H	-	41	-	-	-	-	-	-	-	-	-	-	-	-	-	-	2,037	2,722	2,911	3,909	4,270	5,065
	Arm, Adjustable Height, Black	IN28	27	59	26W x 27.8D x 39-42.5H	1.8	30	1,494	1,585	1,669	1,755	1,846	1,934	2,027	2,141	2,249	2,370	2,554	2,706	2,853	1,669	2,189	2,334	2,884	3,151	3,718	
	Arm, Adjustable Height, Chrome	IN28	27	69	26W x 27.8D x 39-42.5H	1.8	30	1,510	1,601	1,685	1,771	1,862	1,950	2,043	2,157	2,265	2,386	2,570	2,722	2,869	1,685	2,205	2,350	2,900	3,167	3,734	

To Order Select Below

1. Series/Back

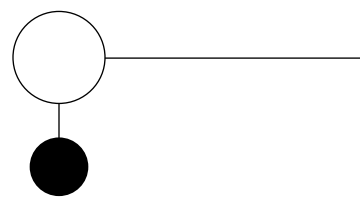

IN26

Insight Chair Upholstered, Medium Back

IN28

Insight Chair Upholstered, High Back

Dimensions
Go to [page 7](#) for product dimension details.

2. Control

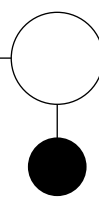

Control

27 MID PIVOT SYNCHRO TILT

Adjustments
Pneumatic Seat Height
Back Angle
Tilt Tension
Optional Seat Slide

3. Arm Choice

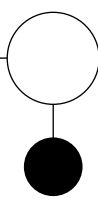

Arm Choice

00	ARMLESS
51	C-ARM, BLACK URETHANE
54	C-ARM, PAINTED, NO ARM CAP
55	C-ARM, PAINTED, PLASTIC ARM CAP
56	C-ARM, PAINTED, UPH ARM CAP
57	C-ARM, FULLY UPH
59	ARM, ADJUSTABLE HEIGHT, BLACK
64	C-ARM, POLISHED, NO ARM CAP
65	C-ARM, POLISHED, PLASTIC ARM CAP
66	C-ARM, POLISHED, UPH ARM CAP
69	ARM, ADJUSTABLE HEIGHT, CHROME

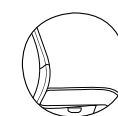

Armless



C-Arm



Adjustable Height

COMs, COLs and in-graded textiles must be approved specifically for upholstered arm caps.

4. Options

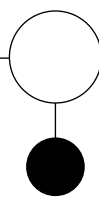

Options

B22	PAINTED ALUMINUM BASE	+86
B23	POLISHED ALUMINUM BASE	+86
R	BLACK RUBBER TIRED CASTERS	+40
CT	CONTRASTING THREAD	
GL	GLIDE SUBSTITUTION	
CU	COORDINATED UPHOLSTERY	+40
SS	SEAT SLIDE	+113
HL	HEIGHT LOCK	+13

Chair Base Options

If a powder coated cast aluminum or polished cast aluminum base option is not selected, the base choice will be black nylon by default.

Coordinated Upholstery

These chairs may be ordered with coordinated upholstery, as opposed to standard matching upholstery on seats and backs. Please contact customer service for details.

Caster Options

Black carpet casters are used on five blade base unless another caster or glide option is chosen.

5. Base Finish

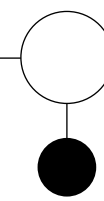

Standard Powder Coated Metal

BL	BLUE	NK	NICKEL
BM	BLACK MATTE	NV	NAVY
BR	BRASS	OR	ORANGE
BT	BLACK TWILIGHT	PY	PALE YELLOW
CP	CHAMPAGNE	RD	RED
DB	DARK BRONZE	RO	RED ORANGE
DG	DARK GRAY	RR	RUSTY RED
DP	DUSTY PINK	SB	SOFT BLUE
FG	FOREST GREEN	SD	SAND
LG	LIGHT GRAY	TC	TERRACOTTA
MG	MEADOW GREEN	TP	TAUPE
MK	MILK	TS	TEXTURED SLATE
MS	METALLIC SILVER	YL	YELLOW

Powder Coated Metal finish selection will be applied to the aluminum base and/or arms per the model codes. Polished arms can be ordered with a painted base or vice-versa by designating one component for painted finish and the other as polished.

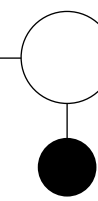

6. Upholstery



See general information section for details on textile program and COM/COL information.

Insight

STOOL: MESH BACK, BASIC SWIVEL

TITLE	BACK	CTRL	ARM	DIMENSIONS	YDG	SF	Textile										Leather										
							COM	COL	COM	COL				COL		W	X	Y	E1	E2							
Medium Back, Mesh Back, Basic Swivel, Bar Stool 	Armless	IN15	61H	00	20.5W x 27.8D x 51.5H	0.75	10	972	1,009	1,045	1,083	1,115	1,154	1,196	1,239	1,283	1,337	1,412	1,475	1,536	1,045	1,181	1,231	1,466	1,516	1,729	
	C-Arm, Black Urethane	IN15	61H	51	25W x 27.8D x 51.5H	0.75	10	1,186	1,223	1,259	1,297	1,329	1,368	1,410	1,453	1,497	1,551	1,626	1,689	1,750	1,259	1,395	1,445	1,680	1,730	1,943	
	C-Arm, Painted, No Arm Cap	IN15	61H	54/64	25W x 27.8D x 51.5H	0.75	10	1,356	1,393	1,429	1,467	1,499	1,538	1,580	1,623	1,667	1,721	1,796	1,859	1,920	1,429	1,565	1,615	1,850	1,900	2,113	
	C-Arm, Painted, Plastic Arm Cap	IN15	61H	55/65	25W x 27.8D x 51.5H	0.75	10	1,393	1,430	1,466	1,504	1,536	1,575	1,617	1,660	1,704	1,758	1,833	1,896	1,957	1,466	1,602	1,652	1,887	1,937	2,150	
	C-Arm, Painted, Uph Arm Cap	IN15	61H	56/66	25W x 27.8D x 51.5H	0.75	10	1,432	1,469	1,505	1,543	1,575	1,614	1,656	1,699	1,743	1,797	1,872	1,935	1,996	1,505	1,641	1,691	1,926	1,976	2,189	
	C-Arm, Fully Uph	IN15	61H	57	25W x 27.8D x 51.5H	-	21	-	-	-	-	-	-	-	-	-	-	-	-	-	-	1,634	2,056	2,168	2,623	2,770	3,205
	Arm, Adjustable Height, Black	IN15	61H	59	26W x 27.8D x 51.5H	0.75	10	1,186	1,223	1,259	1,297	1,329	1,368	1,410	1,453	1,497	1,551	1,626	1,689	1,750	1,259	1,395	1,445	1,680	1,730	1,943	
	Arm, Adjustable Height, Chrome	IN15	61H	69	26W x 27.8D x 51.5H	0.75	10	1,202	1,239	1,275	1,313	1,345	1,384	1,426	1,469	1,513	1,567	1,642	1,705	1,766	1,275	1,411	1,461	1,696	1,746	1,959	
Medium Back, Mesh Back, Basic Swivel, Counter Stool 	Armless	IN15	61M	00	20.5W x 27.8D x 46.5H	0.75	10	972	1,009	1,045	1,083	1,115	1,154	1,196	1,239	1,283	1,337	1,412	1,475	1,536	1,045	1,181	1,231	1,466	1,516	1,729	
	C-Arm, Black Urethane	IN15	61M	51	25W x 27.8D x 46.5H	0.75	10	1,186	1,223	1,259	1,297	1,329	1,368	1,410	1,453	1,497	1,551	1,626	1,689	1,750	1,259	1,395	1,445	1,680	1,730	1,943	
	C-Arm, Painted, No Arm Cap	IN15	61M	54/64	25W x 27.8D x 46.5H	0.75	10	1,356	1,393	1,429	1,467	1,499	1,538	1,580	1,623	1,667	1,721	1,796	1,859	1,920	1,429	1,565	1,615	1,850	1,900	2,113	
	C-Arm, Painted, Plastic Arm Cap	IN15	61M	55/65	25W x 27.8D x 46.5H	0.75	10	1,393	1,430	1,466	1,504	1,536	1,575	1,617	1,660	1,704	1,758	1,833	1,896	1,957	1,466	1,602	1,652	1,887	1,937	2,150	
	C-Arm, Painted, Uph Arm Cap	IN15	61M	56/66	25W x 27.8D x 46.5H	0.75	10	1,432	1,469	1,505	1,543	1,575	1,614	1,656	1,699	1,743	1,797	1,872	1,935	1,996	1,505	1,641	1,691	1,926	1,976	2,189	
	C-Arm, Fully Uph	IN15	61M	57	25W x 27.8D x 46.5H	-	21	-	-	-	-	-	-	-	-	-	-	-	-	-	-	1,634	2,055	2,169	2,623	2,769	3,207
	Arm, Adjustable Height, Black	IN15	61M	59	26W x 27.8D x 46.5H	0.75	10	1,186	1,223	1,259	1,297	1,329	1,368	1,410	1,453	1,497	1,551	1,626	1,689	1,750	1,259	1,395	1,445	1,680	1,730	1,943	
	Arm, Adjustable Height, Chrome	IN15	61M	69	26W x 27.8D x 46.5H	0.75	10	1,202	1,239	1,275	1,313	1,345	1,384	1,426	1,469	1,513	1,567	1,642	1,705	1,766	1,275	1,411	1,461	1,696	1,746	1,959	

To Order Select Below

1. Series/Back

IN15

Insight Stool Mesh, Medium Back

Dimensions
Go to [page 7](#) for product dimension details.

2. Control

61 BASIC SWIVEL

Adjustments
Pneumatic Seat Height

3. Height

H BAR
M COUNTER

3. Arm Choice

00	ARMLESS
51	C-ARM, BLACK URETHANE
54	C-ARM, PAINTED, NO ARM CAP
55	C-ARM, PAINTED, PLASTIC ARM CAP
56	C-ARM, PAINTED, UPH ARM CAP
57	C-ARM, FULLY UPH
59	ARM, ADJUSTABLE HEIGHT, BLACK
64	C-ARM, POLISHED, NO ARM CAP
65	C-ARM, POLISHED, PLASTIC ARM CAP
66	C-ARM, POLISHED, UPH ARM CAP
69	ARM, ADJUSTABLE HEIGHT, CHROME

**Armless**

**C-Arm**

**Adjustable Height**

5. Mesh Choice

38	SILVER
32	ZINC
36	MARINE
31	MUSHROOM
35	CAMEL
33	JAVA
30	ANTHRACITE
34	BLACK ICE

6. Options

B22	PAINTED ALUMINUM BASE	+86
B23	POLISHED ALUMINUM BASE	+86
R	BLACK RUBBER TIRED CASTERS	+40
BG	BUMPER GUARDS	+40
CT	CONTRASTING THREAD	
GL	GLIDE SUBSTITUTION	
HL	HEIGHT LOCK	+13

 Bumper guards are recommended for workstation use.

Chair Base Options
If a powder coated cast aluminum or polished cast aluminum base option is not selected, the base choice will be black nylon by default.

Caster Options
Black carpet casters are used on five blade base unless another caster or glide option is chosen.

7. Base Finish

BL	BLUE	NK	NICKEL
BM	BLACK MATTE	NV	NAVY
BR	BRASS	OR	ORANGE
BT	BLACK TWILIGHT	PY	PALE YELLOW
CP	CHAMPAGNE	RD	RED
DB	DARK BRONZE	RO	RED ORANGE
DG	DARK GRAY	RR	RUSTY RED
DP	DUSTY PINK	SB	SOFT BLUE
FG	FOREST GREEN	SD	SAND
LG	LIGHT GRAY	TC	TERRACOTTA
MG	MEADOW GREEN	TP	TAUPE
MK	MILK	TS	TEXTURED SLATE
MS	METALLIC SILVER	YL	YELLOW

Powder Coated Metal finish selection will be applied to the aluminum base and/or arms per the model codes. Polished arms can be ordered with a painted base or vice-versa by designating one component for painted finish and the other as polished.



8. Upholstery

See general information section for details on textile program and COM/COL information.

COMs, COLs and in-graded textiles must be approved specifically for upholstered arm caps.

Insight

STOOL: UPH BACK, BASIC SWIVEL

TITLE	BACK	CTRL	ARM	DIMENSIONS	YDG	SF	Textile										Leather										
							COM	COL	COM	COL				COL		W	X	Y	E1	E2							
Medium Back, Uph Back, Basic Swivel, Bar Stool 	Armless	IN25	61H	00	20.5W x 27.8D x 51.5H	1.6	28	1,156	1,236	1,313	1,390	1,468	1,550	1,631	1,729	1,826	1,935	2,098	2,233	2,364	1,313	1,800	1,931	2,460	2,725	3,248	
	C-Arm, Black Urethane	IN25	61H	51	25W x 27.8D x 51.5H	1.6	28	1,370	1,450	1,527	1,604	1,682	1,764	1,845	1,943	2,040	2,149	2,312	2,447	2,578	1,527	2,014	2,145	2,674	2,939	3,462	
	C-Arm, Painted, No Arm Cap	IN25	61H	54/64	25W x 27.8D x 51.5H	1.6	28	1,540	1,620	1,697	1,774	1,852	1,934	2,015	2,113	2,210	2,319	2,482	2,617	2,748	1,697	2,184	2,315	2,844	3,109	3,632	
	C-Arm, Painted, Plastic Arm Cap	IN25	61H	55/65	25W x 27.8D x 51.5H	1.6	28	1,577	1,657	1,734	1,811	1,889	1,971	2,052	2,150	2,247	2,356	2,519	2,654	2,785	1,734	2,221	2,352	2,881	3,146	3,669	
	C-Arm, Painted, Uph Arm Cap	IN25	61H	56/66	25W x 27.8D x 51.5H	1.6	28	1,616	1,696	1,773	1,850	1,928	2,010	2,091	2,189	2,286	2,395	2,558	2,693	2,824	1,773	2,260	2,391	2,920	3,185	3,708	
	C-Arm, Fully Uph	IN25	61H	57	25W x 27.8D x 51.5H	-	39	-	-	-	-	-	-	-	-	-	-	-	-	-	-	1,890	2,546	2,720	3,681	4,039	4,790
	Arm, Adjustable Height, Black	IN25	61H	59	26W x 27.8D x 51.5H	1.6	28	1,370	1,450	1,527	1,604	1,682	1,764	1,845	1,943	2,040	2,149	2,312	2,447	2,578	1,527	2,014	2,145	2,674	2,939	3,462	
	Arm, Adjustable Height, Chrome	IN25	61H	69	26W x 27.8D x 51.5H	1.6	28	1,386	1,466	1,543	1,620	1,698	1,780	1,861	1,959	2,056	2,165	2,328	2,463	2,594	1,543	2,030	2,161	2,690	2,955	3,478	
Medium Back, Uph Back, Basic Swivel, Counter Stool 	Armless	IN25	61M	00	20.5W x 27.8D x 46.5H	1.6	28	1,156	1,236	1,313	1,390	1,468	1,550	1,631	1,729	1,826	1,935	2,098	2,233	2,364	1,313	1,800	1,931	2,460	2,725	3,248	
	C-Arm, Black Urethane	IN25	61M	51	25W x 27.8D x 46.5H	1.6	28	1,370	1,450	1,527	1,604	1,682	1,764	1,845	1,943	2,040	2,149	2,312	2,447	2,578	1,527	2,014	2,145	2,674	2,939	3,462	
	C-Arm, Painted, No Arm Cap	IN25	61M	54/64	25W x 27.8D x 46.5H	1.6	28	1,540	1,620	1,697	1,774	1,852	1,934	2,015	2,113	2,210	2,319	2,482	2,617	2,748	1,697	2,184	2,315	2,844	3,109	3,632	
	C-Arm, Painted, Plastic Arm Cap	IN25	61M	55/65	25W x 27.8D x 46.5H	1.6	28	1,577	1,657	1,734	1,811	1,889	1,971	2,052	2,150	2,247	2,356	2,519	2,654	2,785	1,734	2,221	2,352	2,881	3,146	3,669	
	C-Arm, Painted, Uph Arm Cap	IN25	61M	56/66	25W x 27.8D x 46.5H	1.6	28	1,616	1,696	1,773	1,850	1,928	2,010	2,091	2,189	2,286	2,395	2,558	2,693	2,824	1,773	2,260	2,391	2,920	3,185	3,708	
	C-Arm, Fully Uph	IN25	61M	57	25W x 27.8D x 46.5H	-	39	-	-	-	-	-	-	-	-	-	-	-	-	-	-	1,892	2,546	2,720	3,682	4,039	4,790
	Arm, Adjustable Height, Black	IN25	61M	59	26W x 27.8D x 46.5H	1.6	28	1,370	1,450	1,527	1,604	1,682	1,764	1,845	1,943	2,040	2,149	2,312	2,447	2,578	1,527	2,014	2,145	2,674	2,939	3,462	
	Arm, Adjustable Height, Chrome	IN25	61M	69	26W x 27.8D x 46.5H	1.6	28	1,386	1,466	1,543	1,620	1,698	1,780	1,861	1,959	2,056	2,165	2,328	2,463	2,594	1,543	2,030	2,161	2,690	2,955	3,478	

To Order Select Below

1. Series/Back

IN25

Insight Stool Upholstered, Medium Back

Dimensions
Go to [page 7](#) for product dimension details.

2. Control

61 BASIC SWIVEL



Adjustments
Pneumatic Seat Height

3. Height

H BAR
M COUNTER

4. Arm Choice

00 ARMLESS
51 C-ARM, BLACK URETHANE
54 C-ARM, PAINTED, NO ARM CAP
55 C-ARM, PAINTED, PLASTIC ARM CAP
56 C-ARM, PAINTED, UPH ARM CAP
57 C-ARM, FULLY UPH
59 ARM, ADJUSTABLE HEIGHT, BLACK
64 C-ARM, POLISHED, NO ARM CAP
65 C-ARM, POLISHED, PLASTIC ARM CAP
66 C-ARM, POLISHED, UPH ARM CAP
69 ARM, ADJUSTABLE HEIGHT, CHROME

 **Armless**  **C-Arm**  **Adjustable Height**

COMs, COLs and in-graded textiles must be approved specifically for upholstered arm caps.

5. Options

B22 PAINTED ALUMINUM BASE **+86**
B23 POLISHED ALUMINUM BASE **+86**
R BLACK RUBBER TIRED CASTERS **+40**
CT CONTRASTING THREAD
GL GLIDE SUBSTITUTION
CU COORDINATED UPHOLSTERY **+40**
HL HEIGHT LOCK **+13**

Chair Base Options
If a powder coated cast aluminum or polished cast aluminum base option is not selected, the base choice will be black nylon by default.

Coordinated Upholstery
These chairs may be ordered with coordinated upholstery, as opposed to standard matching upholstery on seats and backs. Please contact customer service for details.

Caster Options
Black carpet casters are used on five blade base unless another caster or glide option is chosen.

6. Base Finish

Standard Powder Coated Metal

BL BLUE
BM BLACK MATTE
BR BRASS
BT BLACK TWILIGHT
CP CHAMPAGNE
DB DARK BRONZE
DG DARK GRAY
DP DUSTY PINK
FG FOREST GREEN
LG LIGHT GRAY
MG MEADOW GREEN
MK MILK
MS METALLIC SILVER

NK NICKEL
NV NAVY
OR ORANGE
PY PALE YELLOW
RD RED
RO RED ORANGE
RR RUSTY RED
SB SOFT BLUE
SD SAND
TC TERRACOTTA
TP TAUPE
TS TEXTURED SLATE
YL YELLOW



Powder Coated Metal finish selection will be applied to the aluminum base and/or arms per the model codes. Polished arms can be ordered with a painted base or vice-versa by designating one component for painted finish and the other as polished.

7. Upholstery

See general information section for details on textile program and COM/COL information.

Insight

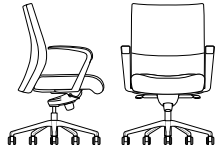
EXECUTIVE CHAIR: CENTER PIVOT TILT

TITLE	BACK	CTRL	ARM	DIMENSIONS	YDG	SF	Textile					Leather															
							COM	COL	COM	COL				COM	COL	COM	COL	COM	COL	COM	COL	COM	COL	COM	COL		
 Medium Back, Center Pivot Tilt,	Armless	IN46	10	00	20.5W x 27.8D x 35.5-39H	2.0	32	1,154	1,246	1,332	1,418	1,503	1,596	1,687	1,800	1,940	2,108	2,266	2,428	2,584	1,332	1,885	2,055	2,478	2,867	3,273	
	C-Arm, Black Urethane	IN46	10	51	25W x 27.8D x 35.5-39H	2.0	32	1,368	1,460	1,546	1,632	1,717	1,810	1,901	2,014	2,154	2,322	2,480	2,642	2,798	1,546	2,099	2,269	2,692	3,081	3,487	
	C-Arm, Painted, No Arm Cap	IN46	10	54/64	25W x 27.8D x 35.5-39H	2.0	32	1,538	1,630	1,716	1,802	1,887	1,980	2,071	2,184	2,324	2,492	2,650	2,812	2,968	1,716	2,269	2,439	2,862	3,251	3,657	
	C-Arm, Painted, Plastic Arm Cap	IN46	10	55/65	25W x 27.8D x 35.5-39H	2.0	32	1,575	1,667	1,753	1,839	1,924	2,017	2,108	2,221	2,361	2,529	2,687	2,849	3,005	1,753	2,306	2,476	2,899	3,288	3,694	
	C-Arm, Painted, Uph Arm Cap	IN46	10	56/66	25W x 27.8D x 35.5-39H	2.0	32	1,614	1,706	1,792	1,878	1,963	2,056	2,147	2,260	2,400	2,568	2,726	2,888	3,044	1,792	2,345	2,515	2,938	3,327	3,733	
	C-Arm, Fully Uph	IN46	10	57	25W x 27.8D x 35.5-39H	-	40	-	-	-	-	-	-	-	-	-	-	-	-	-	-	1,853	2,880	3,116	3,700	4,246	4,808
	Arm, Adjustable Height, Black	IN46	10	59	26W x 27.8D x 35.5-39H	2.0	32	1,368	1,460	1,546	1,632	1,717	1,810	1,901	2,014	2,154	2,322	2,480	2,642	2,798	1,546	2,099	2,269	2,692	3,081	3,487	
	Arm, Adjustable Height, Chrome	IN46	10	69	26W x 27.8D x 35.5-39H	2.0	32	1,384	1,476	1,562	1,648	1,733	1,826	1,917	2,030	2,170	2,338	2,496	2,658	2,814	1,562	2,115	2,285	2,708	3,097	3,503	
 High Back, Center Pivot Tilt,	Armless	IN48	10	00	20.5W x 27.8D x 39-42.5H	2.2	35	1,195	1,292	1,381	1,471	1,559	1,658	1,758	1,873	2,022	2,200	2,366	2,536	2,700	1,381	2,011	2,201	2,675	3,114	3,570	
	C-Arm, Black Urethane	IN48	10	51	25W x 27.8D x 39-42.5H	2.2	35	1,409	1,506	1,595	1,685	1,773	1,872	1,972	2,087	2,236	2,414	2,580	2,750	2,914	1,595	2,225	2,415	2,889	3,328	3,784	
	C-Arm, Painted, No Arm Cap	IN48	10	54/64	25W x 27.8D x 39-42.5H	2.2	35	1,579	1,676	1,765	1,855	1,943	2,042	2,142	2,257	2,406	2,584	2,750	2,920	3,084	1,765	2,395	2,585	3,059	3,498	3,954	
	C-Arm, Painted, Plastic Arm Cap	IN48	10	55/65	25W x 27.8D x 39-42.5H	2.2	35	1,616	1,713	1,802	1,892	1,980	2,079	2,179	2,294	2,443	2,621	2,787	2,957	3,121	1,802	2,432	2,622	3,096	3,535	3,991	
	C-Arm, Painted, Uph Arm Cap	IN48	10	56/66	25W x 27.8D x 39-42.5H	2.2	35	1,655	1,752	1,841	1,931	2,019	2,118	2,218	2,333	2,482	2,660	2,826	2,996	3,160	1,841	2,471	2,661	3,135	3,574	4,030	
	C-Arm, Fully Uph	IN48	10	57	25W x 27.8D x 39-42.5H	-	43	-	-	-	-	-	-	-	-	-	-	-	-	-	-	1,948	3,092	3,355	4,010	4,620	5,250
	Arm, Adjustable Height, Black	IN48	10	59	26W x 27.8D x 39-42.5H	2.2	35	1,409	1,506	1,595	1,685	1,773	1,872	1,972	2,087	2,236	2,414	2,580	2,750	2,914	1,595	2,225	2,415	2,889	3,328	3,784	
	Arm, Adjustable Height, Chrome	IN48	10	69	26W x 27.8D x 39-42.5H	2.2	35	1,425	1,522	1,611	1,701	1,789	1,888	1,988	2,103	2,252	2,430	2,596	2,766	2,930	1,611	2,241	2,431	2,905	3,344	3,800	

To Order Select Below

1. Series/Back

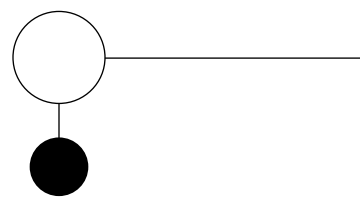

IN46

Insight Executive Chair, Upholstered, Medium Back

IN48

Insight Executive Chair, Upholstered, High Back

Dimensions

Go to [page 7](#) for product dimension details.

2. Control

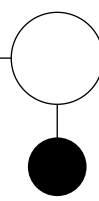

Control

10 CENTER PIVOT TILT

Adjustments

Pneumatic Seat Height
Tilt Tension
Tilt Lockout

3. Arm Choice

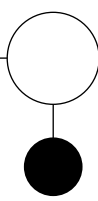

Arm Choice

00 ARMLESS

51 C-ARM, BLACK URETHANE

54 C-ARM, PAINTED, NO ARM CAP

55 C-ARM, PAINTED, PLASTIC ARM CAP

56 C-ARM, PAINTED, UPH ARM CAP

57 C-ARM, FULLY UPH

59 ARM, ADJUSTABLE HEIGHT, BLACK

64 C-ARM, POLISHED, NO ARM CAP

65 C-ARM, POLISHED, PLASTIC ARM CAP

66 C-ARM, POLISHED, UPH ARM CAP

69 ARM, ADJUSTABLE HEIGHT, CHROME

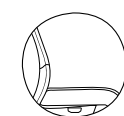

Armless



C-Arm



Adjustable Height

COMs, COLs and in-graded textiles must be approved specifically for upholstered arm caps.

4. Options

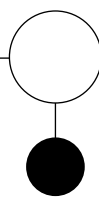

Options

B10 PLASTIC BASE **-72**

B22 PAINTED ALUMINUM BASE

B23 POLISHED ALUMINUM BASE

R BLACK RUBBER TIRED CASTERS **+40**

CT CONTRASTING THREAD

GL GLIDE SUBSTITUTION

CU COORDINATED UPHOLSTERY **+40**

HL HEIGHT LOCK **+13**

Chair Base Options

If a powder coated cast aluminum or polished cast aluminum base option is not selected, the base choice will be black nylon by default.

Coordinated Upholstery

These chairs may be ordered with coordinated upholstery, as opposed to standard matching upholstery on seats and backs. Please contact customer service for details.

Caster Options

Black carpet casters are used on five blade base unless another caster or glide option is chosen.

5. Base Finish

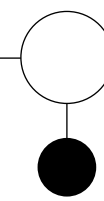

Standard Powder Coated Metal

BL BLUE

BM BLACK MATTE

BR BRASS

BT BLACK TWILIGHT

CP CHAMPAGNE

DB DARK BRONZE

DG DARK GRAY

DP DUSTY PINK

FG FOREST GREEN

LG LIGHT GRAY

MG MEADOW GREEN

MK MILK

MS METALLIC SILVER

NK NICKEL

NV NAVY

OR ORANGE

PY PALE YELLOW

RD RED

RO RED ORANGE

RR RUSTY RED

SB SOFT BLUE

SD SAND

TC TERRACOTTA

TP TAUPE

TS TEXTURED SLATE

YL YELLOW

6. Upholstery

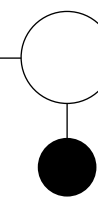



See general information section for details on textile program and COM/COL information.

Powder Coated Metal finish selection will be applied to the aluminum base and/or arms per the model codes. Polished arms can be ordered with a painted base or vice-versa by designating one component for painted finish and the other as polished.

Insight

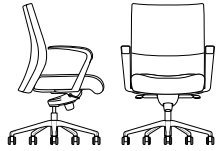
EXECUTIVE CHAIR: MID PIVOT TILT

TITLE	BACK	CTRL	ARM	DIMENSIONS	YDG	SF	Textile										Leather										
							COM	COL	COM	COL				COL		W	X	Y	E1	E2							
 Medium Back, Mid Pivot Tilt,	Armless	IN46	16	00	20.5W x 27.8D x 35.5-39H	2.0	32	1,269	1,359	1,443	1,529	1,613	1,707	1,801	1,909	2,053	2,222	2,378	2,540	2,696	1,443	2,002	2,172	2,594	2,985	3,388	
	C-Arm, Black Urethane	IN46	16	51	25W x 27.8D x 35.5-39H	2.0	32	1,483	1,573	1,657	1,743	1,827	1,921	2,015	2,123	2,267	2,436	2,592	2,754	2,910	1,657	2,216	2,386	2,808	3,199	3,602	
	C-Arm, Painted, No Arm Cap	IN46	16	54/64	25W x 27.8D x 35.5-39H	2.0	32	1,653	1,743	1,827	1,913	1,997	2,091	2,185	2,293	2,437	2,606	2,762	2,924	3,080	1,827	2,386	2,556	2,978	3,369	3,772	
	C-Arm, Painted, Plastic Arm Cap	IN46	16	55/65	25W x 27.8D x 35.5-39H	2.0	32	1,690	1,780	1,864	1,950	2,034	2,128	2,222	2,330	2,474	2,643	2,799	2,961	3,117	1,864	2,423	2,593	3,015	3,406	3,809	
	C-Arm, Painted, Uph Arm Cap	IN46	16	56/66	25W x 27.8D x 35.5-39H	2.0	32	1,729	1,819	1,903	1,989	2,073	2,167	2,261	2,369	2,513	2,682	2,838	3,000	3,156	1,903	2,462	2,632	3,054	3,445	3,848	
	C-Arm, Fully Uph	IN46	16	57	25W x 27.8D x 35.5-39H	-	40	-	-	-	-	-	-	-	-	-	-	-	-	-	-	2,022	3,084	3,323	3,930	4,491	5,070
	Arm, Adjustable Height, Black	IN46	16	59	26W x 27.8D x 35.5-39H	2.0	32	1,483	1,573	1,657	1,743	1,827	1,921	2,015	2,123	2,267	2,436	2,592	2,754	2,910	1,657	2,216	2,386	2,808	3,199	3,602	
	Arm, Adjustable Height, Chrome	IN46	16	69	26W x 27.8D x 35.5-39H	2.0	32	1,499	1,589	1,673	1,759	1,843	1,937	2,031	2,139	2,283	2,452	2,608	2,770	2,926	1,673	2,232	2,402	2,824	3,215	3,618	
 High Back, Mid Pivot Tilt,	Armless	IN48	16	00	20.5W x 27.8D x 39-42.5H	2.2	35	1,306	1,404	1,490	1,582	1,672	1,770	1,869	1,986	2,133	2,313	2,479	2,649	2,814	1,490	2,128	2,321	2,791	3,232	3,687	
	C-Arm, Black Urethane	IN48	16	51	25W x 27.8D x 39-42.5H	2.2	35	1,520	1,618	1,704	1,796	1,886	1,984	2,083	2,200	2,347	2,527	2,693	2,863	3,028	1,704	2,342	2,535	3,005	3,446	3,901	
	C-Arm, Painted, No Arm Cap	IN48	16	54/64	25W x 27.8D x 39-42.5H	2.2	35	1,690	1,788	1,874	1,966	2,056	2,154	2,253	2,370	2,517	2,697	2,863	3,033	3,198	1,874	2,512	2,705	3,175	3,616	4,071	
	C-Arm, Painted, Plastic Arm Cap	IN48	16	55/65	25W x 27.8D x 39-42.5H	2.2	35	1,727	1,825	1,911	2,003	2,093	2,191	2,290	2,407	2,554	2,734	2,900	3,070	3,235	1,911	2,549	2,742	3,212	3,653	4,108	
	C-Arm, Painted, Uph Arm Cap	IN48	16	56/66	25W x 27.8D x 39-42.5H	2.2	35	1,766	1,864	1,950	2,042	2,132	2,230	2,329	2,446	2,593	2,773	2,939	3,109	3,274	1,950	2,588	2,781	3,251	3,692	4,147	
	C-Arm, Fully Uph	IN48	16	57	25W x 27.8D x 39-42.5H	-	43	-	-	-	-	-	-	-	-	-	-	-	-	-	-	2,063	3,212	3,473	4,128	4,736	5,369
	Arm, Adjustable Height, Black	IN48	16	59	26W x 27.8D x 39-42.5H	2.2	35	1,520	1,618	1,704	1,796	1,886	1,984	2,083	2,200	2,347	2,527	2,693	2,863	3,028	1,704	2,342	2,535	3,005	3,446	3,901	
	Arm, Adjustable Height, Chrome	IN48	16	69	26W x 27.8D x 39-42.5H	2.2	35	1,536	1,634	1,720	1,812	1,902	2,000	2,099	2,216	2,363	2,543	2,709	2,879	3,044	1,720	2,358	2,551	3,021	3,462	3,917	

To Order Select Below

1. Series/Back

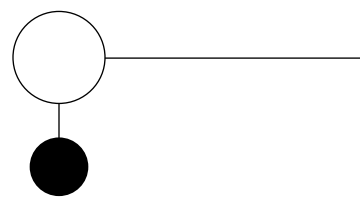

IN46

Insight Executive Chair, Upholstered, Medium Back

IN48

Insight Executive Chair, Upholstered, High Back

Dimensions

Go to [page 7](#) for product dimension details.

2. Control

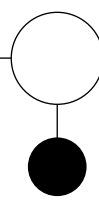

Control

16 MID PIVOT TILT

Adjustments

Pneumatic Seat Height
Tilt Tension
Tilt Lockout

3. Arm Choice

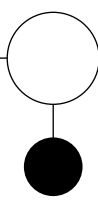

Arm Choice

00 ARMLESS

51 C-ARM, BLACK URETHANE

54 C-ARM, PAINTED, NO ARM CAP

55 C-ARM, PAINTED, PLASTIC ARM CAP

56 C-ARM, PAINTED, UPH ARM CAP

57 C-ARM, FULLY UPH

59 ARM, ADJUSTABLE HEIGHT, BLACK

64 C-ARM, POLISHED, NO ARM CAP

65 C-ARM, POLISHED, PLASTIC ARM CAP

66 C-ARM, POLISHED, UPH ARM CAP

69 ARM, ADJUSTABLE HEIGHT, CHROME

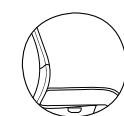

Armless



C-Arm



Adjustable Height

COMs, COLs and in-graded textiles must be approved specifically for upholstered arm caps.

4. Options

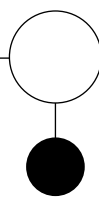

Options

B10 PLASTIC BASE **-72**

B22 PAINTED ALUMINUM BASE

B23 POLISHED ALUMINUM BASE

R BLACK RUBBER TIRED CASTERS **+40**

CT CONTRASTING THREAD

GL GLIDE SUBSTITUTION

CU COORDINATED UPHOLSTERY **+40**

HL HEIGHT LOCK **+13**

Chair Base Options

If a powder coated cast aluminum or polished cast aluminum base option is not selected, the base choice will be black nylon by default.

Coordinated Upholstery

These chairs may be ordered with coordinated upholstery, as opposed to standard matching upholstery on seats and backs. Please contact customer service for details.

Caster Options

Black carpet casters are used on five blade base unless another caster or glide option is chosen.

5. Base Finish

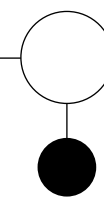

Standard Powder Coated Metal

BL BLUE

BM BLACK MATTE

BR BRASS

BT BLACK TWILIGHT

CP CHAMPAGNE

DB DARK BRONZE

DG DARK GRAY

DP DUSTY PINK

FG FOREST GREEN

LG LIGHT GRAY

MG MEADOW GREEN

MK MILK

MS METALLIC SILVER

NK NICKEL

NV NAVY

OR ORANGE

PY PALE YELLOW

RD RED

RO RED ORANGE

RR RUSTY RED

SB SOFT BLUE

SD SAND

TC TERRACOTTA

TP TAUPE

TS TEXTURED SLATE

YL YELLOW

Powder Coated Metal finish selection will be applied to the aluminum base and/or arms per the model codes. Polished arms can be ordered with a painted base or vice-versa by designating one component for painted finish and the other as polished.

6. Upholstery

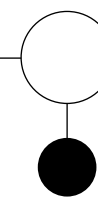

See [general information section](#) for details on textile program and COM/COL information.

Insight

EXECUTIVE CHAIR: MID PIVOT TILT

TITLE	BACK	CTRL	ARM	DIMENSIONS	YDG	SF	Textile					Leather															
							COM	COL	COM	COL				COM	COL	COM	COL	COM	COL	COM	COL	COM	COL	COM	COL		
							A	B	C	D	E	F	G	H	I	J	K	L	M	COL	W	X	Y	E1	E2		
 Tall Back, Mid Pivot Tilt,	Armless	IN49	16	00	20.5W x 27.8D x 45.3-49H	2.4	36	1,350	1,456	1,555	1,653	1,751	1,859	1,970	2,096	2,263	2,455	2,639	2,826	3,008	1,555	2,220	2,415	2,916	3,380	3,860	
	C-Arm, Black Urethane	IN49	16	51	25W x 27.8D x 45.3-49H	2.4	36	1,564	1,670	1,769	1,867	1,965	2,073	2,184	2,310	2,477	2,669	2,853	3,040	3,222	1,769	2,434	2,629	3,130	3,594	4,074	
	C-Arm, Painted, No Arm Cap	IN49	16	54/64	25W x 27.8D x 45.3-49H	2.4	36	1,734	1,840	1,939	2,037	2,135	2,243	2,354	2,480	2,647	2,839	3,023	3,210	3,392	1,939	2,604	2,799	3,300	3,764	4,244	
	C-Arm, Painted, Plastic Arm Cap	IN49	16	55/65	25W x 27.8D x 45.3-49H	2.4	36	1,771	1,877	1,976	2,074	2,172	2,280	2,391	2,517	2,684	2,876	3,060	3,247	3,429	1,976	2,641	2,836	3,337	3,801	4,281	
	C-Arm, Painted, Uph Arm Cap	IN49	16	56/66	25W x 27.8D x 45.3-49H	2.4	36	1,810	1,916	2,015	2,113	2,211	2,319	2,430	2,556	2,723	2,915	3,099	3,286	3,468	2,015	2,680	2,875	3,376	3,840	4,320	
	C-Arm, Fully Uph	IN49	16	57	25W x 27.8D x 45.3-49H	-	44	-	-	-	-	-	-	-	-	-	-	-	-	-	-	2,106	3,298	3,571	4,255	4,886	5,540
	Arm, Adjustable Height, Black	IN49	16	59	26W x 27.8D x 45.3-49H	2.4	36	1,564	1,670	1,769	1,867	1,965	2,073	2,184	2,310	2,477	2,669	2,853	3,040	3,222	1,769	2,434	2,629	3,130	3,594	4,074	
	Arm, Adjustable Height, Chrome	IN49	16	69	26W x 27.8D x 45.3-49H	2.4	36	1,580	1,686	1,785	1,883	1,981	2,089	2,200	2,326	2,493	2,685	2,869	3,056	3,238	1,785	2,450	2,645	3,146	3,610	4,090	

To Order Select Below

1. Series/Back

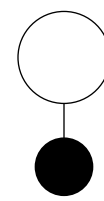

IN49

Insight Executive Chair, Upholstered, Tall Back

Dimensions

Go to **page 7** for product dimension details.

2. Control

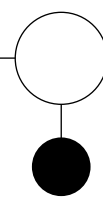

Control

16 MID PIVOT TILT

Adjustments

Pneumatic Seat Height
Tilt Tension
Tilt Lockout

3. Arm Choice

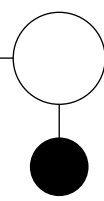

Arm Choice

00 ARMLESS

51 C-ARM, BLACK URETHANE

54 C-ARM, PAINTED, NO ARM CAP

55 C-ARM, PAINTED, PLASTIC ARM CAP

56 C-ARM, PAINTED, UPH ARM CAP

57 C-ARM, FULLY UPH

59 ARM, ADJUSTABLE HEIGHT, BLACK

64 C-ARM, POLISHED, NO ARM CAP

65 C-ARM, POLISHED, PLASTIC ARM CAP

66 C-ARM, POLISHED, UPH ARM CAP

69 ARM, ADJUSTABLE HEIGHT, CHROME

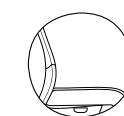

Armless



C-Arm



Adjustable Height

COMs, COLs and in-graded textiles must be approved specifically for upholstered arm caps.

4. Options

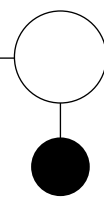

Options

B10 PLASTIC BASE **-72**

B22 PAINTED ALUMINUM BASE

B23 POLISHED ALUMINUM BASE

R BLACK RUBBER TIRED CASTERS **+40**

CT CONTRASTING THREAD

GL GLIDE SUBSTITUTION

CU COORDINATED UPHOLSTERY **+40**

HL HEIGHT LOCK **+13**

Chair Base Options

If a powder coated cast aluminum or polished cast aluminum base option is not selected, the base choice will be black nylon by default.

Coordinated Upholstery

These chairs may be ordered with coordinated upholstery, as opposed to standard matching upholstery on seats and backs. Please contact customer service for details.

Caster Options

Black carpet casters are used on five blade base unless another caster or glide option is chosen.

5. Base Finish

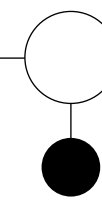

Standard Powder Coated Metal

BL BLUE

BM BLACK MATTE

BR BRASS

BT BLACK TWILIGHT

CP CHAMPAGNE

DB DARK BRONZE

DG DARK GRAY

DP DUSTY PINK

FG FOREST GREEN

LG LIGHT GRAY

MG MEADOW GREEN

MK MILK

MS METALLIC SILVER

NK NICKEL

NV NAVY

OR ORANGE

PY PALE YELLOW

RD RED

RO RED ORANGE

RR RUSTY RED

SB SOFT BLUE

SD SAND

TC TERRACOTTA

TP TAUPE

TS TEXTURED SLATE

YL YELLOW

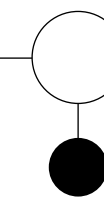

6. Upholstery



See general information section for details on textile program and COM/COL information.

Insight

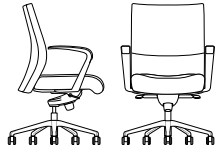
EXECUTIVE CHAIR: MID PIVOT SYNCHRO TILT

TITLE	BACK	CTRL	ARM	DIMENSIONS	YDG	SF	Textile										Leather										
							COM	COL	COM	COL				COL		W	X	Y	E1	E2							
 Medium Back, Mid Pivot Synchro Tilt,	Armless	IN46	27	00	20.5W x 27.8D x 35.5-39H	2.0	32	1,380	1,471	1,555	1,640	1,726	1,818	1,910	2,022	2,163	2,334	2,489	2,651	2,807	1,555	2,122	2,290	2,710	3,104	3,505	
	C-Arm, Black Urethane	IN46	27	51	25W x 27.8D x 35.5-39H	2.0	32	1,594	1,685	1,769	1,854	1,940	2,032	2,124	2,236	2,377	2,548	2,703	2,865	3,021	1,769	2,336	2,504	2,924	3,318	3,719	
	C-Arm, Painted, No Arm Cap	IN46	27	54/64	25W x 27.8D x 35.5-39H	2.0	32	1,764	1,855	1,939	2,024	2,110	2,202	2,294	2,406	2,547	2,718	2,873	3,035	3,191	1,939	2,506	2,674	3,094	3,488	3,889	
	C-Arm, Painted, Plastic Arm Cap	IN46	27	55/65	25W x 27.8D x 35.5-39H	2.0	32	1,801	1,892	1,976	2,061	2,147	2,239	2,331	2,443	2,584	2,755	2,910	3,072	3,228	1,976	2,543	2,711	3,131	3,525	3,926	
	C-Arm, Painted, Uph Arm Cap	IN46	27	56/66	25W x 27.8D x 35.5-39H	2.0	32	1,840	1,931	2,015	2,100	2,186	2,278	2,370	2,482	2,623	2,794	2,949	3,111	3,267	2,015	2,582	2,750	3,170	3,564	3,965	
	C-Arm, Fully Uph	IN46	27	57	25W x 27.8D x 35.5-39H	-	40	-	-	-	-	-	-	-	-	-	-	-	-	-	-	2,133	3,203	3,443	4,046	4,610	5,187
	Arm, Adjustable Height, Black	IN46	27	59	26W x 27.8D x 35.5-39H	2.0	32	1,594	1,685	1,769	1,854	1,940	2,032	2,124	2,236	2,377	2,548	2,703	2,865	3,021	1,769	2,336	2,504	2,924	3,318	3,719	
	Arm, Adjustable Height, Chrome	IN46	27	69	26W x 27.8D x 35.5-39H	2.0	32	1,610	1,701	1,785	1,870	1,956	2,048	2,140	2,252	2,393	2,564	2,719	2,881	3,037	1,785	2,352	2,520	2,940	3,334	3,735	
 High Back, Mid Pivot Synchro Tilt,	Armless	IN48	27	00	20.5W x 27.8D x 39-42.5H	2.2	35	1,420	1,515	1,603	1,695	1,782	1,882	1,979	2,096	2,244	2,424	2,588	2,758	2,922	1,603	2,244	2,436	2,910	3,348	3,802	
	C-Arm, Black Urethane	IN48	27	51	25W x 27.8D x 39-42.5H	2.2	35	1,634	1,729	1,817	1,909	1,996	2,096	2,193	2,310	2,458	2,638	2,802	2,972	3,136	1,817	2,458	2,650	3,124	3,562	4,016	
	C-Arm, Painted, No Arm Cap	IN48	27	54/64	25W x 27.8D x 39-42.5H	2.2	35	1,804	1,899	1,987	2,079	2,166	2,266	2,363	2,480	2,628	2,808	2,972	3,142	3,306	1,987	2,628	2,820	3,294	3,732	4,186	
	C-Arm, Painted, Plastic Arm Cap	IN48	27	55/65	25W x 27.8D x 39-42.5H	2.2	35	1,841	1,936	2,024	2,116	2,203	2,303	2,400	2,517	2,665	2,845	3,009	3,179	3,343	2,024	2,665	2,857	3,331	3,769	4,223	
	C-Arm, Painted, Uph Arm Cap	IN48	27	56/66	25W x 27.8D x 39-42.5H	2.2	35	1,880	1,975	2,063	2,155	2,242	2,342	2,439	2,556	2,704	2,884	3,048	3,218	3,382	2,063	2,704	2,896	3,370	3,808	4,262	
	C-Arm, Fully Uph	IN48	27	57	25W x 27.8D x 39-42.5H	-	43	-	-	-	-	-	-	-	-	-	-	-	-	-	-	2,174	3,327	3,588	4,244	4,852	5,483
	Arm, Adjustable Height, Black	IN48	27	59	26W x 27.8D x 39-42.5H	2.2	35	1,634	1,729	1,817	1,909	1,996	2,096	2,193	2,310	2,458	2,638	2,802	2,972	3,136	1,817	2,458	2,650	3,124	3,562	4,016	
	Arm, Adjustable Height, Chrome	IN48	27	69	26W x 27.8D x 39-42.5H	2.2	35	1,650	1,745	1,833	1,925	2,012	2,112	2,209	2,326	2,474	2,654	2,818	2,988	3,152	1,833	2,474	2,666	3,140	3,578	4,032	

To Order Select Below

1. Series/Back

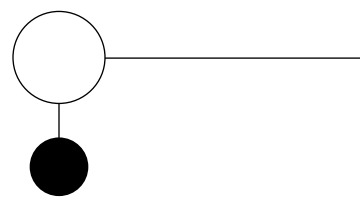

IN46
Insight Executive Chair, Upholstered, Medium Back

IN48
Insight Executive Chair, Upholstered, High Back

Dimensions
Go to [page 7](#) for product dimension details.

2. Control

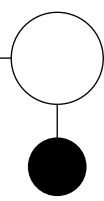

Control

27 VARIABLE TASK MID PIVOT SYNCHRO TILT

Adjustments
Pneumatic Seat Height
Back Angle
Tilt Tension
Optional Seat Slide

3. Arm Choice

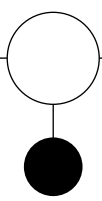

Arm Choice

00 ARMLESS
51 C-ARM, BLACK URETHANE
54 C-ARM, PAINTED, NO ARM CAP
55 C-ARM, PAINTED, PLASTIC ARM CAP
56 C-ARM, PAINTED, UPH ARM CAP
57 C-ARM, FULLY UPH
59 ARM, ADJUSTABLE HEIGHT, BLACK
64 C-ARM, POLISHED, NO ARM CAP
65 C-ARM, POLISHED, PLASTIC ARM CAP
66 C-ARM, POLISHED, UPH ARM CAP
69 ARM, ADJUSTABLE HEIGHT, CHROME

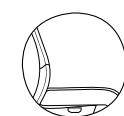

Armless



C-Arm



Adjustable Height

COMs, COLs and in-graded textiles must be approved specifically for upholstered arm caps.

4. Options

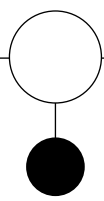

Options

B10 PLASTIC BASE **-72**
B22 PAINTED ALUMINUM BASE
B23 POLISHED ALUMINUM BASE
R BLACK RUBBER TIRED CASTERS **+40**
CT CONTRASTING THREAD
GL GLIDE SUBSTITUTION
CU COORDINATED UPHOLSTERY **+40**
SS SEAT SLIDE **+113**
HL HEIGHT LOCK **+13**

Chair Base Options

If a powder coated cast aluminum or polished cast aluminum base option is not selected, the base choice will be black nylon by default.

Coordinated Upholstery

These chairs may be ordered with coordinated upholstery, as opposed to standard matching upholstery on seats and backs. Please contact customer service for details.

Caster Options

Black carpet casters are used on five blade base unless another caster or glide option is chosen.

5. Base Finish

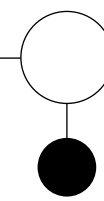

Standard Powder Coated Metal

BL BLUE	NK NICKEL
BM BLACK MATTE	NV NAVY
BR BRASS	OR ORANGE
BT BLACK TWILIGHT	PY PALE YELLOW
CP CHAMPAGNE	RD RED
DB DARK BRONZE	RO RED ORANGE
DG DARK GRAY	RR RUSTY RED
DP DUSTY PINK	SB SOFT BLUE
FG FOREST GREEN	SD SAND
LG LIGHT GRAY	TC TERRACOTTA
MG MEADOW GREEN	TP TAUPE
MK MILK	TS TEXTURED SLATE
MS METALLIC SILVER	YL YELLOW

Powder Coated Metal finish selection will be applied to the aluminum base and/or arms per the model codes. Polished arms can be ordered with a painted base or vice-versa by designating one component for painted finish and the other as polished.

6. Upholstery

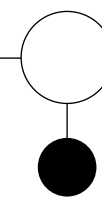

See general information section for details on textile program and COM/COL information.

Insight

EXECUTIVE CHAIR: MID PIVOT SYNCHRO TILT

TITLE	BACK	CTRL	ARM	DIMENSIONS	YDG	SF	Textile					Leather														
							COM	COL	COM	COL				COM	COL	COM	COL	COM	COL	COM	COL	COM	COL	COM	COL	
Tall Back, Mid Pivot Synchro Tilt,	Armless	IN49	27	00	20.5W x 27.8D x 45.3-49H	2.4	36	1,464	1,569	1,668	1,766	1,865	1,973	2,082	2,206	2,371	2,568	2,749	2,936	3,116	1,668	2,336	2,533	3,032	3,498	3,977
	C-Arm, Black Urethane	IN49	27	51	25W x 27.8D x 45.3-49H	2.4	36	1,678	1,783	1,882	1,980	2,079	2,187	2,296	2,420	2,585	2,782	2,963	3,150	3,330	1,882	2,550	2,747	3,246	3,712	4,191
	C-Arm, Painted, No Arm Cap	IN49	27	54/64	25W x 27.8D x 45.3-49H	2.4	36	1,848	1,953	2,052	2,150	2,249	2,357	2,466	2,590	2,755	2,952	3,133	3,320	3,500	2,052	2,720	2,917	3,416	3,882	4,361
	C-Arm, Painted, Plastic Arm Cap	IN49	27	55/65	25W x 27.8D x 45.3-49H	2.4	36	1,885	1,990	2,089	2,187	2,286	2,394	2,503	2,627	2,792	2,989	3,170	3,357	3,537	2,089	2,757	2,954	3,453	3,919	4,398
	C-Arm, Painted, Uph Arm Cap	IN49	27	56/66	25W x 27.8D x 45.3-49H	2.4	36	1,924	2,029	2,128	2,226	2,325	2,433	2,542	2,666	2,831	3,028	3,209	3,396	3,576	2,128	2,796	2,993	3,492	3,958	4,437
	C-Arm, Fully Uph	IN49	27	57	25W x 27.8D x 45.3-49H	-	44	-	-	-	-	-	-	-	-	-	-	-	-	-	2,220	3,416	3,688	4,369	5,003	5,657
	Arm, Adjustable Height, Black	IN49	27	59	26W x 27.8D x 45.3-49H	2.4	36	1,678	1,783	1,882	1,980	2,079	2,187	2,296	2,420	2,585	2,782	2,963	3,150	3,330	1,882	2,550	2,747	3,246	3,712	4,191
	Arm, Adjustable Height, Chrome	IN49	27	69	26W x 27.8D x 45.3-49H	2.4	36	1,694	1,799	1,898	1,996	2,095	2,203	2,312	2,436	2,601	2,798	2,979	3,166	3,346	1,898	2,566	2,763	3,262	3,728	4,207

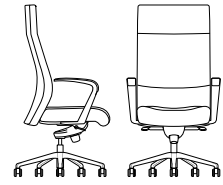

To Order Select Below

1. Series/Back

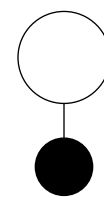

IN49

Insight Executive Chair, Upholstered, Tall Back

Dimensions

Go to **page 7** for product dimension details.

2. Control

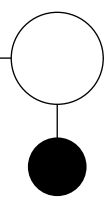

Control

27 VARIABLE TASK MID PIVOT SYNCHRO TILT

Adjustments

Pneumatic Seat Height
Back Angle
Tilt Tension
Optional Seat Slide

3. Arm Choice

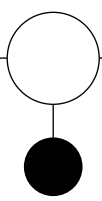

Arm Choice

00 ARMLESS
51 C-ARM, BLACK URETHANE
54 C-ARM, PAINTED, NO ARM CAP
55 C-ARM, PAINTED, PLASTIC ARM CAP
56 C-ARM, PAINTED, UPH ARM CAP
57 C-ARM, FULLY UPH
59 ARM, ADJUSTABLE HEIGHT, BLACK
64 C-ARM, POLISHED, NO ARM CAP
65 C-ARM, POLISHED, PLASTIC ARM CAP
66 C-ARM, POLISHED, UPH ARM CAP
69 ARM, ADJUSTABLE HEIGHT, CHROME

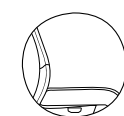

Armless



C-Arm



Adjustable Height

COMs, COLs and in-graded textiles must be approved specifically for upholstered arm caps.

4. Options

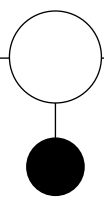

Options

B10 PLASTIC BASE **-72**
B22 PAINTED ALUMINUM BASE
B23 POLISHED ALUMINUM BASE
R BLACK RUBBER TIRED CASTERS **+40**
CT CONTRASTING THREAD
GL GLIDE SUBSTITUTION
CU COORDINATED UPHOLSTERY **+40**
SS SEAT SLIDE **+113**
HL HEIGHT LOCK **+13**

Chair Base Options

If a powder coated cast aluminum or polished cast aluminum base option is not selected, the base choice will be black nylon by default.

Coordinated Upholstery

These chairs may be ordered with coordinated upholstery, as opposed to standard matching upholstery on seats and backs. Please contact customer service for details.

Caster Options

Black carpet casters are used on five blade base unless another caster or glide option is chosen.

5. Base Finish

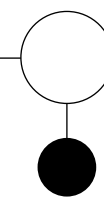

Standard Powder Coated Metal

BL BLUE	NK NICKEL
BM BLACK MATTE	NV NAVY
BR BRASS	OR ORANGE
BT BLACK TWILIGHT	PY PALE YELLOW
CP CHAMPAGNE	RD RED
DB DARK BRONZE	RO RED ORANGE
DG DARK GRAY	RR RUSTY RED
DP DUSTY PINK	SB SOFT BLUE
FG FOREST GREEN	SD SAND
LG LIGHT GRAY	TC TERRACOTTA
MG MEADOW GREEN	TP TAUPE
MK MILK	TS TEXTURED SLATE
MS METALLIC SILVER	YL YELLOW

Powder Coated Metal finish selection will be applied to the aluminum base and/or arms per the model codes. Polished arms can be ordered with a painted base or vice-versa by designating one component for painted finish and the other as polished.

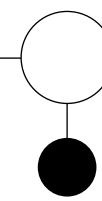

6. Upholstery



See general information section for details on textile program and COM/COL information.

Insight

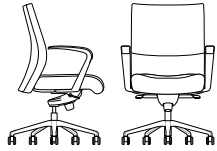
EXECUTIVE CHAIR: FORWARD PIVOT KNEE TILT

TITLE	BACK	CTRL	ARM	DIMENSIONS	YDG	SF	Textile										Leather										
							COM	COL	COM	COL				COM	COL	COL	COL	COL	COL	COL	COL	COL	COL	COL	COL	COL	COL
TITLE	BACK	CTRL	ARM	DIMENSIONS	YDG	SF	A	B	C	D	E	F	G	H	I	J	K	L	M	COL	W	X	Y	E1	E2		
Medium Back, Executive Forward Pivot Knee Tilt, 	Armless	IN46	38	00	20.5W x 27.8D x 37.8-41.5H	2.0	32	1,380	1,471	1,555	1,640	1,726	1,818	1,910	2,022	2,163	2,334	2,489	2,651	2,807	1,555	2,122	2,290	2,710	3,104	3,505	
	C-Arm, Black Urethane	IN46	38	51	25W x 27.8D x 37.8-41.5H	2.0	32	1,594	1,685	1,769	1,854	1,940	2,032	2,124	2,236	2,377	2,548	2,703	2,865	3,021	1,769	2,336	2,504	2,924	3,318	3,719	
	C-Arm, Painted, No Arm Cap	IN46	38	54/64	25W x 27.8D x 37.8-41.5H	2.0	32	1,764	1,855	1,939	2,024	2,110	2,202	2,294	2,406	2,547	2,718	2,873	3,035	3,191	1,939	2,506	2,674	3,094	3,488	3,889	
	C-Arm, Painted, Plastic Arm Cap	IN46	38	55/65	25W x 27.8D x 37.8-41.5H	2.0	32	1,801	1,892	1,976	2,061	2,147	2,239	2,331	2,443	2,584	2,755	2,910	3,072	3,228	1,976	2,543	2,711	3,131	3,525	3,926	
	C-Arm, Painted, Uph Arm Cap	IN46	38	56/66	25W x 27.8D x 37.8-41.5H	2.0	32	1,840	1,931	2,015	2,100	2,186	2,278	2,370	2,482	2,623	2,794	2,949	3,111	3,267	2,015	2,582	2,750	3,170	3,564	3,965	
	C-Arm, Fully Uph	IN46	38	57	25W x 27.8D x 37.8-41.5H	-	40	-	-	-	-	-	-	-	-	-	-	-	-	-	-	2,133	3,203	3,443	4,046	4,610	5,187
	Arm, Adjustable Height, Black	IN46	38	59	26W x 27.8D x 37.8-41.5H	2.0	32	1,594	1,685	1,769	1,854	1,940	2,032	2,124	2,236	2,377	2,548	2,703	2,865	3,021	1,769	2,336	2,504	2,924	3,318	3,719	
	Arm, Adjustable Height, Chrome	IN46	38	69	26W x 27.8D x 37.8-41.5H	2.0	32	1,610	1,701	1,785	1,870	1,956	2,048	2,140	2,252	2,393	2,564	2,719	2,881	3,037	1,785	2,352	2,520	2,940	3,334	3,735	
High Back, Executive Forward Pivot Knee Tilt, 	Armless	IN48	38	00	20.5W x 27.8D x 41.3-45.5H	2.2	35	1,420	1,515	1,603	1,695	1,782	1,882	1,979	2,096	2,244	2,424	2,588	2,758	2,922	1,603	2,244	2,436	2,910	3,348	3,802	
	C-Arm, Black Urethane	IN48	38	51	25W x 27.8D x 41.3-45.5H	2.2	35	1,634	1,729	1,817	1,909	1,996	2,096	2,193	2,310	2,458	2,638	2,802	2,972	3,136	1,817	2,458	2,650	3,124	3,562	4,016	
	C-Arm, Painted, No Arm Cap	IN48	38	54/64	25W x 27.8D x 41.3-45.5H	2.2	35	1,804	1,899	1,987	2,079	2,166	2,266	2,363	2,480	2,628	2,808	2,972	3,142	3,306	1,987	2,628	2,820	3,294	3,732	4,186	
	C-Arm, Painted, Plastic Arm Cap	IN48	38	55/65	25W x 27.8D x 41.3-45.5H	2.2	35	1,841	1,936	2,024	2,116	2,203	2,303	2,400	2,517	2,665	2,845	3,009	3,179	3,343	2,024	2,665	2,857	3,331	3,769	4,223	
	C-Arm, Painted, Uph Arm Cap	IN48	38	56/66	25W x 27.8D x 41.3-45.5H	2.2	35	1,880	1,975	2,063	2,155	2,242	2,342	2,439	2,556	2,704	2,884	3,048	3,218	3,382	2,063	2,704	2,896	3,370	3,808	4,262	
	C-Arm, Fully Uph	IN48	38	57	25W x 27.8D x 41.3-45.5H	-	43	-	-	-	-	-	-	-	-	-	-	-	-	-	-	2,174	3,327	3,588	4,244	4,852	5,483
	Arm, Adjustable Height, Black	IN48	38	59	26W x 27.8D x 41.3-45.5H	2.2	35	1,634	1,729	1,817	1,909	1,996	2,096	2,193	2,310	2,458	2,638	2,802	2,972	3,136	1,817	2,458	2,650	3,124	3,562	4,016	
	Arm, Adjustable Height, Chrome	IN48	38	69	26W x 27.8D x 41.3-45.5H	2.2	35	1,650	1,745	1,833	1,925	2,012	2,112	2,209	2,326	2,474	2,654	2,818	2,988	3,152	1,833	2,474	2,666	3,140	3,578	4,032	

To Order Select Below

1. Series/Back

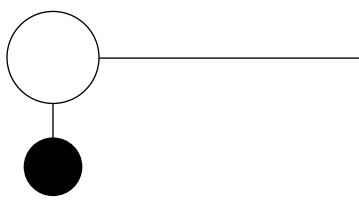

- IN46
- Insight Executive Chair, Upholstered, Medium Back**
- IN48
- Insight Executive Chair, Upholstered, High Back**

Dimensions
Go to [page 7](#) for product dimension details.

2. Control

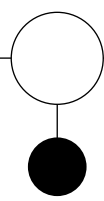

Control

- EXECUTIVE FORWARD PIVOT KNEE TILT

Adjustments
Pneumatic Seat Height
Tilt Tension
Multi-Angle Tilt Lockout

3. Arm Choice

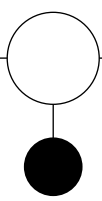

Arm Choice

- 00 ARMLESS
- 51 C-ARM, BLACK URETHANE
- 54 C-ARM, PAINTED, NO ARM CAP
- 55 C-ARM, PAINTED, PLASTIC ARM CAP
- 56 C-ARM, PAINTED, UPH ARM CAP
- 57 C-ARM, FULLY UPH
- 59 ARM, ADJUSTABLE HEIGHT, BLACK
- 64 C-ARM, POLISHED, NO ARM CAP
- 65 C-ARM, POLISHED, PLASTIC ARM CAP
- 66 C-ARM, POLISHED, UPH ARM CAP
- 69 ARM, ADJUSTABLE HEIGHT, CHROME

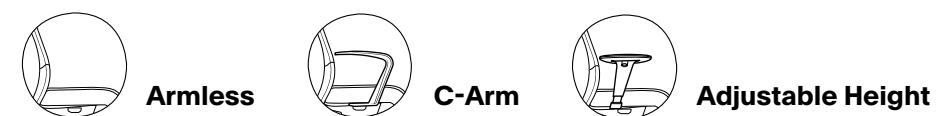

COMs, COLs and in-graded textiles must be approved specifically for upholstered arm caps.

4. Options

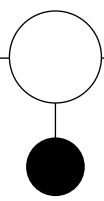

Options

- B10 PLASTIC BASE **-72**
- B22 PAINTED ALUMINUM BASE
- B23 POLISHED ALUMINUM BASE
- R BLACK RUBBER TIRED CASTERS **+40**
- CT CONTRASTING THREAD
- GL GLIDE SUBSTITUTION
- CU COORDINATED UPHOLSTERY **+40**
- HL HEIGHT LOCK **+13**

Chair Base Options

If a powder coated cast aluminum or polished cast aluminum base option is not selected, the base choice will be black nylon by default.

Coordinated Upholstery

These chairs may be ordered with coordinated upholstery, as opposed to standard matching upholstery on seats and backs. Please contact customer service for details.

Caster Options

Black carpet casters are used on five blade base unless another caster or glide option is chosen.

5. Base Finish

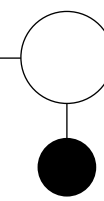

Standard Powder Coated Metal

- BL BLUE
- NK NICKEL
- BM BLACK MATTE
- NV NAVY
- BR BRASS
- OR ORANGE
- BT BLACK TWILIGHT
- PY PALE YELLOW
- CP CHAMPAGNE
- RD RED
- DB DARK BRONZE
- RO RED ORANGE
- DG DARK GRAY
- RR RUSTY RED
- DP DUSTY PINK
- SB SOFT BLUE
- FG FOREST GREEN
- SD SAND
- LG LIGHT GRAY
- TC TERRACOTTA
- MG MEADOW GREEN
- TP TAUPE
- MK MILK
- TS TEXTURED SLATE
- MS METALLIC SILVER
- YL YELLOW

Powder Coated Metal finish selection will be applied to the aluminum base and/or arms per the model codes. Polished arms can be ordered with a painted base or vice-versa by designating one component for painted finish and the other as polished.

6. Upholstery

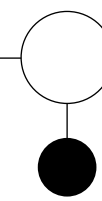

See [general information section](#) for details on textile program and COM/COL information.

Insight

EXECUTIVE CHAIR: FORWARD PIVOT KNEE TILT

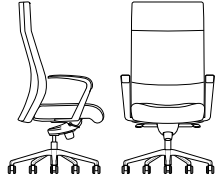
TITLE	BACK	CTRL	ARM	DIMENSIONS	YDG	SF	Textile										Leather									
							COM	COL	COM	COL				COM		COL										
							A	B	C	D	E	F	G	H	I	J	K	L	M	COL	W	X	Y	E1	E2	
Tall Back, Executive Forward Pivot Knee Tilt, 	Armless	IN49	38	00	20.5W x 27.8D x 45.3-49H	2.4	36	1,464	1,569	1,668	1,766	1,865	1,973	2,082	2,206	2,371	2,568	2,749	2,936	3,116	1,668	2,336	2,533	3,032	3,498	3,977
	C-Arm, Black Urethane	IN49	38	51	25W x 27.8D x 45.3-49H	2.4	36	1,678	1,783	1,882	1,980	2,079	2,187	2,296	2,420	2,585	2,782	2,963	3,150	3,330	1,882	2,550	2,747	3,246	3,712	4,191
	C-Arm, Painted, No Arm Cap	IN49	38	54/64	25W x 27.8D x 45.3-49H	2.4	36	1,848	1,953	2,052	2,150	2,249	2,357	2,466	2,590	2,755	2,952	3,133	3,320	3,500	2,052	2,720	2,917	3,416	3,882	4,361
	C-Arm, Painted, Plastic Arm Cap	IN49	38	55/65	25W x 27.8D x 45.3-49H	2.4	36	1,885	1,990	2,089	2,187	2,286	2,394	2,503	2,627	2,792	2,989	3,170	3,357	3,537	2,089	2,757	2,954	3,453	3,919	4,398
	C-Arm, Painted, Uph Arm Cap	IN49	38	56/66	25W x 27.8D x 45.3-49H	2.4	36	1,924	2,029	2,128	2,226	2,325	2,433	2,542	2,666	2,831	3,028	3,209	3,396	3,576	2,128	2,796	2,993	3,492	3,958	4,437
	C-Arm, Fully Uph	IN49	38	57	25W x 27.8D x 45.3-49H	-	44	-	-	-	-	-	-	-	-	-	-	-	-	-	2,220	3,416	3,688	4,369	5,003	5,657
	Arm, Adjustable Height, Black	IN49	38	59	26W x 27.8D x 45.3-49H	2.4	36	1,678	1,783	1,882	1,980	2,079	2,187	2,296	2,420	2,585	2,782	2,963	3,150	3,330	1,882	2,550	2,747	3,246	3,712	4,191
Arm, Adjustable Height, Chrome	IN49	38	69	26W x 27.8D x 45.3-49H	2.4	36	1,694	1,799	1,898	1,996	2,095	2,203	2,312	2,436	2,601	2,798	2,979	3,166	3,346	1,898	2,566	2,763	3,262	3,728	4,207	

To Order Select Below

1. Series/Back

IN49

Insight Executive Chair, Upholstered, Tall Back

Dimensions
Go to [page 7](#) for product dimension details.

2. Control

38 EXECUTIVE FORWARD PIVOT KNEE TILT

Adjustments
Pneumatic Seat Height
Tilt Tension
Multi-Angle Tilt Lockout

3. Arm Choice

00	ARMLESS
51	C-ARM, BLACK URETHANE
54	C-ARM, PAINTED, NO ARM CAP
55	C-ARM, PAINTED, PLASTIC ARM CAP
56	C-ARM, PAINTED, UPH ARM CAP
57	C-ARM, FULLY UPH
59	ARM, ADJUSTABLE HEIGHT, BLACK
64	C-ARM, POLISHED, NO ARM CAP
65	C-ARM, POLISHED, PLASTIC ARM CAP
66	C-ARM, POLISHED, UPH ARM CAP
69	ARM, ADJUSTABLE HEIGHT, CHROME

**Armless**

**C-Arm**

**Adjustable Height**

COMs, COLs and in-graded textiles must be approved specifically for upholstered arm caps.

4. Options

B10	PLASTIC BASE	-72
B22	PAINTED ALUMINUM BASE	
B23	POLISHED ALUMINUM BASE	
R	BLACK RUBBER TIRED CASTERS	+40
CT	CONTRASTING THREAD	
GL	GLIDE SUBSTITUTION	
CU	COORDINATED UPHOLSTERY	+40
HL	HEIGHT LOCK	+13

Chair Base Options
If a powder coated cast aluminum or polished cast aluminum base option is not selected, the base choice will be black nylon by default.

Coordinated Upholstery
These chairs may be ordered with coordinated upholstery, as opposed to standard matching upholstery on seats and backs. Please contact customer service for details.

Caster Options
Black carpet casters are used on five blade base unless another caster or glide option is chosen.

5. Base Finish

BL	BLUE	NK	NICKEL
BM	BLACK MATTE	NV	NAVY
BR	BRASS	OR	ORANGE
BT	BLACK TWILIGHT	PY	PALE YELLOW
CP	CHAMPAGNE	RD	RED
DB	DARK BRONZE	RO	RED ORANGE
DG	DARK GRAY	RR	RUSTY RED
DP	DUSTY PINK	SB	SOFT BLUE
FG	FOREST GREEN	SD	SAND
LG	LIGHT GRAY	TC	TERRACOTTA
MG	MEADOW GREEN	TP	TAUPE
MK	MILK	TS	TEXTURED SLATE
MS	METALLIC SILVER	YL	YELLOW

Powder Coated Metal finish selection will be applied to the aluminum base and/or arms per the model codes. Polished arms can be ordered with a painted base or vice-versa by designating one component for painted finish and the other as polished.

6. Upholstery

See [general information section](#) for details on [textile program and COM/COL information](#).

stylex

Insight Executive

PRICE LIST
Effective November 1, 2022

insight executive
fully upholstered
swivel

PRODUCT INFORMATION

APPLICATIONS:

EXECUTIVE / CONFERENCE

MEDIUM SEAT
MEDIUM BACK

MEDIUM SEAT
HIGH BACK

MEDIUM SEAT
TALL BACK

GENERAL INFORMATION

DIMENSIONS / OVERVIEW

SIZE 6 MEDIUM BACK

SIZE 8 HIGH BACK

SIZE 9 TALL BACK

GENERAL DIMENSIONS

- A. SEAT HEIGHT*
- B. SEAT DEPTH
- C. BACK HEIGHT
- D. SEAT WIDTH & OVERALL WIDTH (ARMLESS)
- E. MAXIMUM OVERALL HEIGHT*

* MEASUREMENTS GIVEN ARE ACCURATE FOR 38 CONTROL. SPECIFIC MODELS MAY VARY SLIGHTLY.

- A. 17.25" - 21"
- B. 19"
- C. 20.5"
- D. 20.5"
- E. 37.75" - 41.5"

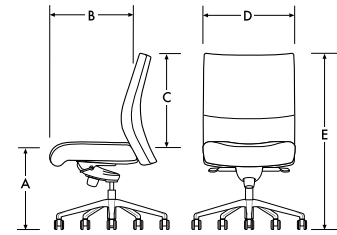

- A. 17.25" - 21"
- B. 19"
- C. 24"
- D. 20.5"
- E. 41.25" - 45.5"

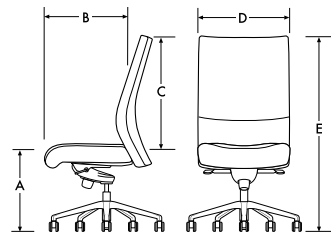

- A. 17.25" - 21"
- B. 19"
- C. 28"
- D. 20.5"
- E. 45.25" - 49"

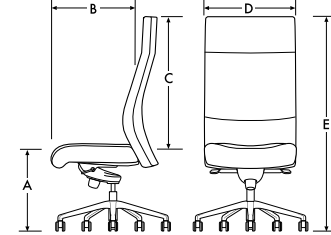

T-SHAPE ADJUSTABLE ARM OPTION

- A. OVERALL WIDTH
- B. DISTANCE BETWEEN ARMS
- C. ARM HEIGHT

- A. 26"
- B. 19"
- C. 6.5" - 9.5"

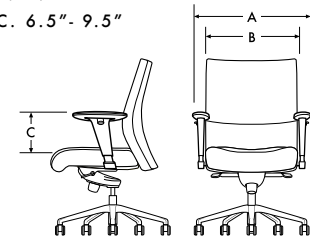

- A. 26"
- B. 19"
- C. 6.5" - 9.5"

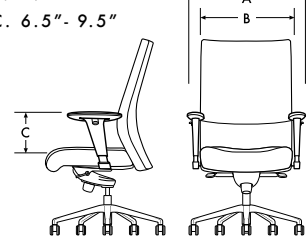

- A. 26"
- B. 19"
- C. 6.5" - 9.5"

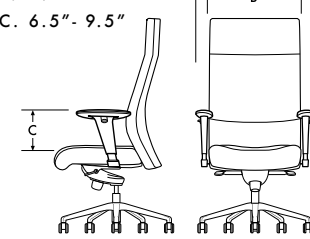

CANTILEVERED FIXED ARM OPTION

- A. OVERALL WIDTH
- B. DISTANCE BETWEEN ARMS
- C. ARM HEIGHT

- A. 25"
- B. 21"
- C. 8.5"

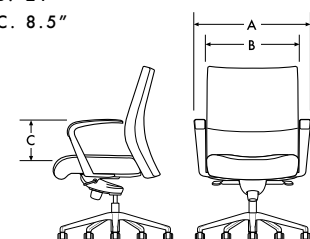

- A. 25"
- B. 21"
- C. 8.5"

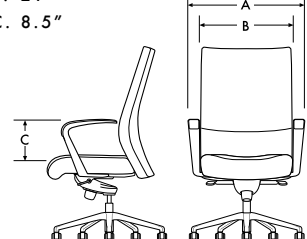

- A. 25"
- B. 21"
- C. 8.5"

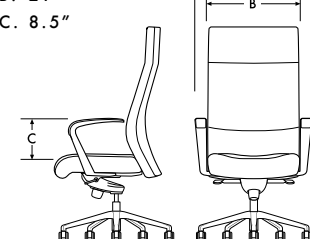

DESIGN
STYLEX

BACK CONSTRUCTION

BACKS CONSIST OF AN UPHOLSTERED COVER PULLED OVER AN ELASTOMERIC SUB-SURFACE ENCASED IN A 5/8" STEEL ROD FRAME. ON THE FRONT SIDE, BETWEEN THE SUB-SURFACE AND THE UPHOLSTERY IS 1/2" OF RESILIENT FOAM.

SEAT CONSTRUCTION

SEATS INCORPORATE COMPOUND CURVE PLYWOOD COVERED WITH CUSHIONS OF CFC-FREE POLYURETHANE.

ARMS

HEIGHT-ADJUSTABLE AND FIXED HEIGHT T-ARMS HAVE PADS MADE FROM SELF-SKINNED URETHANE OVER A STEEL FRAME. FIXED HEIGHT CANTILEVER ARMS MAY BE BLACK POLYURETHANE, UPHOLSTERED, OR CAST ALUMINUM. ALUMINUM ARMS MAY BE POLISHED OR PAINTED WITH OR WITHOUT CAPS. CAPS MAY BE UPHOLSTERED OR BLACK PLASTIC.

BASES

THE STANDARD FIVE PRONG BASE IS CAST ALUMINUM AVAILABLE EITHER WITH HIGHLY POLISHED FINISH OR A CHOICE OF POWDER COAT FINISHES. AN OPTIONAL BLACK GLASS-FILLED NYLON BASE IS AVAILABLE AS A LESS EXPENSIVE ALTERNATIVE.

CASTERS

OPTIONAL RUBBER-TIRED CASTERS MUST BE USED ON HARD FLOORS SUCH AS WOOD, LINOLEUM OR CONCRETE. PLEASE BE SURE TO SPECIFY RUBBER-TIRED CASTERS FOR THESE APPLICATIONS.

TESTING

MANUFACTURED TO COMPLY WITH ANSI/BIFMA X5.1 GENERAL OFFICE CHAIR TESTS.

ENVIRONMENT

GREENGUARD CERTIFIED.



insight executive
fully upholstered
swivel

GENERAL ENVIRONMENT

DESCRIPTION

FABRIC
UPHOLSTERY
GRADES

LEATHER UPHOLSTERY
GRADES

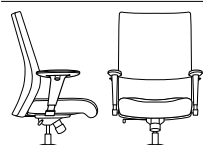
SERIES	STYLE	SIZE	CONTROL	ARMS	DESCRIPTION	C.O.M. YDG.	C.O.L. SQ.FT.	FABRIC UPHOLSTERY GRADES											LEATHER UPHOLSTERY GRADES							
								A	B	C	D	E	F	G	H	I	J	W	X	Y	E1	E2				
	MEDIUM BACK					ARMLESS	2.0	32	1,099	1,187	1,269	1,350	1,431	1,520	1,607	1,714	1,848	2,008	1,795	1,957	2,360	2,730	3,117			
	IN	4	6	10	00				2.0	32	1,315	1,403	1,482	1,563	1,646	1,734	1,823	1,927	2,061	2,225	2,022	2,182	2,583	2,957	3,339	
	IN	4	6	10	59				2.0	32	1,331	1,416	1,499	1,579	1,659	1,750	1,837	1,941	2,076	2,239	2,037	2,198	2,598	2,972	3,357	
	IN	4	6	10	51				2.0	32	1,315	1,403	1,482	1,563	1,646	1,734	1,823	1,927	2,061	2,225	2,022	2,182	2,583	2,957	3,339	
	IN	4	6	10	54/64				2.0	32	1,483	1,570	1,651	1,731	1,812	1,901	1,992	2,095	2,230	2,392	2,198	2,360	2,759	3,132	3,518	
	IN	4	6	10	55/65				2.0	32	1,522	1,609	1,690	1,769	1,851	1,940	2,029	2,133	2,270	2,431	2,239	2,398	2,800	3,174	3,559	
	HIGH BACK					FIXED HEIGHT C-ARM, BLACK URETHANE	2.0	32	1,561	1,648	1,727	1,809	1,891	1,979	2,068	2,172	2,308	2,469	2,278	2,438	2,840	3,213	3,599			
	IN	4	6	10	56/66				2.0	32	1,522	1,609	1,690	1,769	1,851	1,940	2,029	2,133	2,270	2,431	2,239	2,398	2,800	3,174	3,559	
	IN	4	6	10	57				40	1,765											2,743	2,968	3,524	4,044	4,579	
	IN	4	8	10	51				2.2	35	1,353	1,444	1,528	1,615	1,698	1,793	1,887	1,997	2,138	2,310	2,138	2,321	2,772	3,191	3,622	
	IN	4	8	10	54/64				2.2	35	1,522	1,614	1,697	1,784	1,869	1,962	2,055	2,166	2,309	2,478	2,317	2,497	2,948	3,369	3,802	
	HIGH BACK					FIXED HEIGHT C-ARM, BLACK URETHANE	2.2	35	1,561	1,651	1,737	1,823	1,906	2,000	2,094	2,205	2,347	2,517	2,358	2,537	2,988	3,407	3,839			
	IN	4	8	10	55/65				2.2	35	1,522	1,614	1,697	1,784	1,869	1,962	2,055	2,166	2,309	2,478	2,317	2,497	2,948	3,369	3,802	
	IN	4	8	10	56/66				2.2	35	1,598	1,690	1,776	1,860	1,944	2,038	2,132	2,243	2,385	2,555	2,397	2,579	3,029	3,447	3,880	
	IN	4	8	10	57				43	1,855												2,945	3,195	3,819	4,400	5,000
	IN	4	8	10	54/64				2.2	35	1,522	1,614	1,697	1,784	1,869	1,962	2,055	2,166	2,309	2,478	2,317	2,497	2,948	3,369	3,802	

TO ORDER FOLLOW STEPS 1-6

1 SERIES/STYLE/SIZE 2 CONTROLS/FUNCTION 3 ARM CHOICES 4 OPTIONS 5 FINISH CHOICES 6 COVER

1 SERIES/STYLE/SIZE

IN 46 UPHOLSTERED MEDIUM BACK
SEAT: MEDIUM
20.5"W X 19"D
BACK: MEDIUM
20.5"H X 20.5"W

IN 48 UPHOLSTERED HIGH BACK
SEAT: MEDIUM
20.5"W X 19"D
BACK: HIGH
24"H X 20.5"W

2 CONTROLS/FUNCTION

10 CENTER PIVOT TILT
ADJUSTMENTS: PNEUMATIC
SEAT HEIGHT, TILT TENSION,
TILT LOCK OUT

3 ARM CHOICES

00 ARMLESS

59 ADJUSTABLE HEIGHT ARM,
BLACK, URETHANE CAP

69 ADJUSTABLE HEIGHT ARM,
CHROME, URETHANE CAP

51 FIXED HEIGHT C-ARM,
BLACK URETHANE

54 FIXED HEIGHT C-ARM,
PAINTED ALUMINUM

64 FIXED HEIGHT C-ARM
POLISHED ALUMINUM

55 FIXED HEIGHT C-ARM,
PAINTED ALUMINUM
WITH PLASTIC CAP

65 FIXED HEIGHT C-ARM,
POLISHED ALUMINUM
WITH PLASTIC CAPS

56 FIXED HEIGHT C-ARM,
PAINTED ALUMINUM
WITH UPHOLSTERED CAP

66 FIXED HEIGHT C-ARM,
POLISHED ALUMINUM
WITH UPHOLSTERED CAP

57 FIXED HEIGHT C-ARM,
UPHOLSTERED

NOTE: COMS, COLS AND
IN-GRADED FABRICS MUST BE
APPROVED SPECIFICALLY FOR
UPHOLSTERED ARM CAPS.

4 OPTIONS

R RUBBER TIRED CASTERS +38

GL GLIDE SUBSTITUTION +00

CT CONTRASTING THREAD +00

B22 PAINTED CAST
ALUMINUM BASE
CHOOSE FINISH +00

B23 POLISHED CAST
ALUMINUM BASE +00

B10 PLASTIC BASE
(BLACK MATTE ONLY) -69

CU COORDINATED
UPHOLSTERY* +38

* COORDINATED UPHOLSTERY
THESE CHAIRS MAY BE ORDERED
WITH COORDINATED UPHOL-
STERY, AS OPPOSED TO STAND-
DARD MATCHING UPHOLSTERY,
ON SEATS AND BACKS. PLEASE
CONTACT CUSTOMER SERVICE
FOR DETAILS.

5 FINISH CHOICES

STANDARD POWDER PAINT +00

BM BLACK MATTE (STD)	NY NAVY*
BT BLACK TWILIGHT*	NK NICKEL*
BL BLUE*	OR ORANGE*
BR BRASS*	PY PALE YELLOW*
CP CHAMPAGNE*	RD RED*
DB DARK BRONZE*	RO RED ORANGE*
DG DARK GRAY*	RR RUSTY RED*
DP DUSTY PINK*	SD SAND*
FG FOREST GREEN*	SB SOFT BLUE*
LG LIGHT GRAY*	TC TERRACOTTA*
MG MEADOW GREEN*	TP TAUPE*
MS METALLIC SILVER*	TS TEXTURED SLATE*
MK MILK*	YL YELLOW*

* THE FINISH SELECTION WILL BE APPLIED
TO THE ALUMINUM BASE AND/OR ARMS
PER THE MODEL CODES.

POLISHED ARMS CAN BE ORDERED WITH A
PAINTED BASE OR VICE VERSA BY DESIGN-
ATING ONE COMPONENT FOR PAINTED
FINISH AND THE OTHER AS POLISHED.

6 COVER

SEE SWATCH CARDS FOR
STANDARD UPHOLSTERY
OPTIONS.

SEE GENERAL INFORMA-
TION SECTION FOR
DETAILS ON COM AND
IN-GRADED FABRIC
PROGRAM.

SEE GENERAL INFORMA-
TION SECTION FOR CAL
133 INFORMATION.



insight executive fully upholstered swivel

CONFERENCE - LIGHT TASK

DESCRIPTION

FABRIC
UPHOLSTERY
GRADES

LEATHER UPHOLSTERY
GRADES

SERIES	STYLE	SIZE	CONTROL	ARMS	DESCRIPTION	C.O.M. YDG.	C.O.L. SQ.FT.	FABRIC UPHOLSTERY GRADES										LEATHER UPHOLSTERY GRADES							
								A	B	C	D	E	F	G	H	I	J	W	X	Y	E1	E2			
	TALL BACK	IN	4	9	16	00	ARMLESS	2.4	36	1,286	1,387	1,481	1,574	1,668	1,770	1,876	1,996	2,155	2,338	2,114	2,300	2,777	3,219	3,676	
		IN	4	9	16	59	ADJUSTABLE HEIGHT, BLACK, URETHANE CAP	2.4	36	1,503	1,603	1,695	1,790	1,882	1,987	2,090	2,211	2,366	2,554	2,336	2,526	3,002	3,443	3,901	
		IN	4	9	16	69	ADJUSTABLE HEIGHT, CHROME, URETHANE CAP	2.4	36	1,518	1,617	1,712	1,805	1,898	2,001	2,105	2,227	2,380	2,568	2,352	2,540	3,019	3,460	3,916	
		IN	4	9	16	51	FIXED HEIGHT C-ARM, BLACK URETHANE	2.4	36	1,503	1,603	1,695	1,790	1,882	1,987	2,090	2,211	2,366	2,554	2,336	2,526	3,002	3,443	3,901	
		IN	4	9	16	54/64	C-ARM, PAINTED OR POLISHED ALUMINUM	2.4	36	1,673	1,769	1,864	1,958	2,052	2,157	2,258	2,378	2,536	2,723	2,513	2,706	3,178	3,620	4,078	
		IN	4	9	16	55/65	C-ARM, PAINTED OR POLISHED, PLASTIC CAP	2.4	36	1,710	1,809	1,901	1,996	2,090	2,192	2,298	2,417	2,573	2,759	2,554	2,742	3,219	3,660	4,118	
		IN	4	9	16	56/66	C-ARM, PAINTED OR POLISHED, UPHOLSTERED CAP	2.4	36	1,749	1,848	1,940	2,035	2,128	2,231	2,335	2,455	2,611	2,799	2,593	2,784	3,259	3,702	4,157	
		IN	4	9	16	57	FIXED HEIGHT C-ARM, FULLY UPHOLSTERED		44												3,141	3,401	4,052	4,653	5,276

TO ORDER FOLLOW STEPS 1-6

1 SERIES/STYLE/SIZE 2 CONTROLS/FUNCTION 3 ARM CHOICES 4 OPTIONS 5 FINISH CHOICES 6 COVER

1 **UPHOLSTERED TALL BACK**
SEAT: MEDIUM
20.5"W X 19"D
BACK: TALL
28"H X 20.5"W

2 **MID PIVOT TILT**
ADJUSTMENTS: PNEUMATIC
SEAT HEIGHT, TILT TENSION,
TILT LOCK

3 **ARM CHOICES**

- 00 ARMLESS
- 59 ADJUSTABLE HEIGHT ARM, BLACK, URETHANE CAP
- 69 ADJUSTABLE HEIGHT ARM, CHROME, URETHANE CAP
- 51 FIXED HEIGHT C-ARM, BLACK URETHANE
- 54 FIXED HEIGHT C-ARM, PAINTED ALUMINUM
- 64 FIXED HEIGHT C-ARM POLISHED ALUMINUM
- 55 FIXED HEIGHT C-ARM, PAINTED ALUMINUM WITH PLASTIC CAP
- 65 FIXED HEIGHT C-ARM, POLISHED ALUMINUM WITH PLASTIC CAPS
- 56 FIXED HEIGHT C-ARM, PAINTED ALUMINUM WITH UPHOLSTERED CAP
- 66 FIXED HEIGHT C-ARM, POLISHED ALUMINUM WITH UPHOLSTERED CAP
- 57 FIXED HEIGHT C-ARM, UPHOLSTERED

NOTE: COMS, COLS AND IN-GRADED FABRICS MUST BE APPROVED SPECIFICALLY FOR UPHOLSTERED ARM CAPS.

4 **OPTIONS**

- R RUBBER TIRED CASTERS +38
- GL GLIDE SUBSTITUTION +00
- CT CONTRASTING THREAD +00
- B22 PAINTED CAST ALUMINUM BASE CHOOSE FINISH +00
- B23 POLISHED CAST ALUMINUM BASE +00
- B10 PLASTIC BASE (BLACK MATTE ONLY) -69
- CU COORDINATED UPHOLSTERY* +38

* COORDINATED UPHOLSTERY THESE CHAIRS MAY BE ORDERED WITH COORDINATED UPHOLSTERY, AS OPPOSED TO STANDARD MATCHING UPHOLSTERY, ON SEATS AND BACKS. PLEASE CONTACT CUSTOMER SERVICE FOR DETAILS.

5 **FINISH CHOICES**

STANDARD POWDER PAINT +00

BM BLACK MATTE (STD)	NY NAVY*
BT BLACK TWILIGHT*	NK NICKEL*
BL BLUE*	OR ORANGE*
BR BRASS*	PY PALE YELLOW*
CP CHAMPAGNE*	RD RED*
DB DARK BRONZE*	RO RED ORANGE*
DG DARK GRAY*	RR RUSTY RED*
DP DUSTY PINK*	SD SAND*
FG FOREST GREEN*	SB SOFT BLUE*
LG LIGHT GRAY*	TC TERRACOTTA*
MG MEADOW GREEN*	TP TAUPE*
MS METALLIC SILVER*	TS TEXTURED SLATE*
MK MILK*	YL YELLOW*

* THE FINISH SELECTION WILL BE APPLIED TO THE ALUMINUM BASE AND/OR ARMS PER THE MODEL CODES.

POLISHED ARMS CAN BE ORDERED WITH A PAINTED BASE OR VICE VERSA BY DESIGNATING ONE COMPONENT FOR PAINTED FINISH AND THE OTHER AS POLISHED.

6 **COVER**

SEE SWATCH CARDS FOR STANDARD UPHOLSTERY OPTIONS.

SEE GENERAL INFORMATION SECTION FOR DETAILS ON COM AND IN-GRADED FABRIC PROGRAM.

SEE GENERAL INFORMATION SECTION FOR CAL 133 INFORMATION.

insight executive fully upholstered swivel

VARIABLE TASK

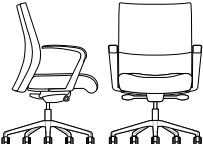
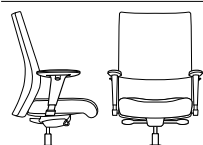
SERIES	STYLE	SIZE	CONTROL	ARMS	DESCRIPTION	C.O.M. YDG.	C.O.L. SQ.FT.	FABRIC UPHOLSTERY GRADES										LEATHER UPHOLSTERY GRADES										
								A	B	C	D	E	F	G	H	I	J	W	X	Y	E1	E2						
	MEDIUM BACK																											
	IN	4	6	27	00	ARMLESS	2.0	32	1,314	1,401	1,481	1,562	1,644	1,731	1,819	1,926	2,060	2,223	2,021	2,181	2,581	2,956	3,338					
	IN	4	6	27	59	ADJUSTABLE HEIGHT, BLACK, URETHANE CAP	2.0	32	1,527	1,615	1,695	1,778	1,855	1,947	2,035	2,138	2,274	2,436	2,244	2,405	2,806	3,178	3,563					
	IN	4	6	27	69	ADJUSTABLE HEIGHT, CHROME, URETHANE CAP	2.0	32	1,544	1,630	1,712	1,792	1,873	1,962	2,051	2,157	2,289	2,451	2,259	2,421	2,822	3,195	3,580					
	IN	4	6	27	51	FIXED HEIGHT C-ARM, BLACK URETHANE	2.0	32	1,527	1,615	1,695	1,778	1,855	1,947	2,035	2,138	2,274	2,436	2,244	2,405	2,806	3,178	3,563					
	IN	4	6	27	54/64	C-ARM, PAINTED OR POLISHED ALUMINUM	2.0	32	1,696	1,784	1,864	1,944	2,027	2,116	2,204	2,309	2,444	2,605	2,421	2,581	2,981	3,356	3,739					
	IN	4	6	27	55/65	C-ARM, PAINTED OR POLISHED, PLASTIC CAP	2.0	32	1,736	1,823	1,901	1,985	2,066	2,156	2,242	2,347	2,480	2,644	2,460	2,621	3,022	3,398	3,780					
	IN	4	6	27	56/66	C-ARM, PAINTED OR POLISHED, UPHOLSTERED CAP	2.0	32	1,774	1,860	1,940	2,024	2,101	2,191	2,279	2,385	2,520	2,683	2,499	2,662	3,064	3,437	3,820					
	IN	4	6	27	57	FIXED HEIGHT C-ARM, FULLY UPHOLSTERED		40				2,031							3,050	3,279	3,853	4,390	4,940					
	IN	4	8	27	00	ARMLESS	2.2	35	1,352	1,443	1,527	1,614	1,697	1,792	1,885	1,996	2,137	2,309	2,137	2,320	2,771	3,189	3,621					
	IN	4	8	27	59	ADJUSTABLE HEIGHT, BLACK, URETHANE CAP	2.2	35	1,565	1,657	1,744	1,828	1,913	2,006	2,098	2,211	2,352	2,522	2,363	2,543	2,995	3,414	3,847					
	IN	4	8	27	69	ADJUSTABLE HEIGHT, CHROME, URETHANE CAP	2.2	35	1,583	1,674	1,758	1,844	1,928	2,024	2,116	2,227	2,367	2,538	2,378	2,562	3,010	3,430	3,863					
	IN	4	8	27	51	FIXED HEIGHT C-ARM, BLACK URETHANE	2.2	35	1,565	1,657	1,744	1,828	1,913	2,006	2,098	2,211	2,352	2,522	2,363	2,543	2,995	3,414	3,847					
	IN	4	8	27	54/64	C-ARM, PAINTED OR POLISHED ALUMINUM	2.2	35	1,736	1,826	1,911	1,996	2,081	2,175	2,270	2,378	2,521	2,691	2,538	2,722	3,173	3,591	4,023					
	IN	4	8	27	55/65	C-ARM, PAINTED OR POLISHED, PLASTIC CAP	2.2	35	1,774	1,864	1,949	2,035	2,120	2,213	2,308	2,417	2,560	2,729	2,580	2,760	3,212	3,630	4,063					
	IN	4	8	27	56/66	C-ARM, PAINTED OR POLISHED, UPHOLSTERED CAP	2.2	35	1,811	1,901	1,988	2,073	2,159	2,251	2,346	2,455	2,597	2,768	2,620	2,803	3,252	3,672	4,103					
	IN	4	8	27	57	FIXED HEIGHT C-ARM, FULLY UPHOLSTERED		43				2,070							3,169	3,417	4,042	4,621	5,222					

TO ORDER FOLLOW STEPS 1-6

1 SERIES/STYLE/SIZE	2 CONTROLS/FUNCTION	3 ARM CHOICES	4 OPTIONS	5 FINISH CHOICES	6 COVER
---------------------	---------------------	---------------	-----------	------------------	---------

<p>IN 46 UPHOLSTERED MEDIUM BACK SEAT: MEDIUM 20.5"W X 19"D BACK: MEDIUM 20.5"H X 20.5"W</p> <p>IN 48 UPHOLSTERED HIGH BACK SEAT: MEDIUM 20.5"W X 19"D BACK: HIGH 24"H X 20.5"W</p>	<p>27 MID PIVOT SYNCHRO TILT ADJUSTMENTS: PNEUMATIC SEAT HEIGHT, BACK ANGLE, TILT TENSION</p>	<p>00 ARMLESS</p> <p>59 ADJUSTABLE HEIGHT ARM, BLACK, URETHANE CAP</p> <p>69 ADJUSTABLE HEIGHT ARM, CHROME, URETHANE CAP</p> <p>51 FIXED HEIGHT C-ARM, BLACK URETHANE</p> <p>54 FIXED HEIGHT C-ARM, PAINTED ALUMINUM</p>	<p>64 FIXED HEIGHT C-ARM POLISHED ALUMINUM</p> <p>55 FIXED HEIGHT C-ARM, PAINTED ALUMINUM WITH PLASTIC CAP</p> <p>65 FIXED HEIGHT C-ARM, POLISHED ALUMINUM WITH PLASTIC CAPS</p> <p>56 FIXED HEIGHT C-ARM, PAINTED ALUMINUM WITH UPHOLSTERED CAP</p> <p>66 FIXED HEIGHT C-ARM, POLISHED ALUMINUM WITH UPHOLSTERED CAP</p> <p>57 FIXED HEIGHT C-ARM, UPHOLSTERED</p> <p><small>NOTE: COMS, COLS AND IN-GRADED FABRICS MUST BE APPROVED SPECIFICALLY FOR UPHOLSTERED ARM CAPS.</small></p>	<p>55 SEAT SLIDE +108</p> <p>R RUBBER TIRED CASTERS +38</p> <p>GL GLIDE SUBSTITUTION +00</p> <p>CT CONTRASTING THREAD +00</p> <p>B22 PAINTED CAST ALUMINUM BASE CHOOSE FINISH +00</p> <p>B23 POLISHED CAST ALUMINUM BASE +00</p> <p>B10 PLASTIC BASE (BLACK MATTE ONLY) -69</p> <p>CU COORDINATED UPHOLSTERY* +38</p> <p><small>* COORDINATED UPHOLSTERY THESE CHAIRS MAY BE ORDERED WITH COORDINATED UPHOL- STERY, AS OPPOSED TO STAN- DARD MATCHING UPHOLSTERY, ON SEATS AND BACKS. PLEASE CONTACT CUSTOMER SERVICE FOR DETAILS.</small></p>	<p>STANDARD POWDER PAINT +00</p> <table border="0"> <tr> <td>BM BLACK MATTE (STD)</td> <td>NY NAVY*</td> </tr> <tr> <td>BT BLACK TWILIGHT*</td> <td>NK NICKEL*</td> </tr> <tr> <td>BL BLUE*</td> <td>OR ORANGE*</td> </tr> <tr> <td>BR BRASS*</td> <td>PY PALE YELLOW*</td> </tr> <tr> <td>CP CHAMPAGNE*</td> <td>RD RED*</td> </tr> <tr> <td>DB DARK BRONZE*</td> <td>RO RED ORANGE*</td> </tr> <tr> <td>DG DARK GRAY*</td> <td>RR RUSTY RED*</td> </tr> <tr> <td>DP DUSTY PINK*</td> <td>SD SAND*</td> </tr> <tr> <td>FG FOREST GREEN*</td> <td>SB SOFT BLUE*</td> </tr> <tr> <td>LG LIGHT GRAY*</td> <td>TC TERRACOTTA*</td> </tr> <tr> <td>MG MEADOW GREEN*</td> <td>TP TAUPE*</td> </tr> <tr> <td>MS METALLIC SILVER*</td> <td>TS TEXTURED SLATE*</td> </tr> <tr> <td>MK MILK*</td> <td>YL YELLOW*</td> </tr> </table> <p><small>* THE FINISH SELECTION WILL BE APPLIED TO THE ALUMINUM BASE AND/OR ARMS PER THE MODEL CODES.</small></p> <p><small>POLISHED ARMS CAN BE ORDERED WITH A PAINTED BASE OR VICE VERSA BY DESIG- NATING ONE COMPONENT FOR PAINTED FINISH AND THE OTHER AS POLISHED.</small></p>	BM BLACK MATTE (STD)	NY NAVY*	BT BLACK TWILIGHT*	NK NICKEL*	BL BLUE*	OR ORANGE*	BR BRASS*	PY PALE YELLOW*	CP CHAMPAGNE*	RD RED*	DB DARK BRONZE*	RO RED ORANGE*	DG DARK GRAY*	RR RUSTY RED*	DP DUSTY PINK*	SD SAND*	FG FOREST GREEN*	SB SOFT BLUE*	LG LIGHT GRAY*	TC TERRACOTTA*	MG MEADOW GREEN*	TP TAUPE*	MS METALLIC SILVER*	TS TEXTURED SLATE*	MK MILK*	YL YELLOW*	<p>SEE SWATCH CARDS FOR STANDARD UPHOLSTERY OPTIONS.</p> <p>SEE GENERAL INFORMA- TION SECTION FOR DETAILS ON COM AND IN-GRADED FABRIC PROGRAM.</p> <p>SEE GENERAL INFORMA- TION SECTION FOR CAL 133 INFORMATION.</p>
BM BLACK MATTE (STD)	NY NAVY*																															
BT BLACK TWILIGHT*	NK NICKEL*																															
BL BLUE*	OR ORANGE*																															
BR BRASS*	PY PALE YELLOW*																															
CP CHAMPAGNE*	RD RED*																															
DB DARK BRONZE*	RO RED ORANGE*																															
DG DARK GRAY*	RR RUSTY RED*																															
DP DUSTY PINK*	SD SAND*																															
FG FOREST GREEN*	SB SOFT BLUE*																															
LG LIGHT GRAY*	TC TERRACOTTA*																															
MG MEADOW GREEN*	TP TAUPE*																															
MS METALLIC SILVER*	TS TEXTURED SLATE*																															
MK MILK*	YL YELLOW*																															

insight executive fully upholstered swivel

VARIABLE TASK

DESCRIPTION

FABRIC
UPHOLSTERY
GRADES

LEATHER UPHOLSTERY
GRADES

SERIES	STYLE	SIZE	CONTROL	ARMS	DESCRIPTION	C.O.M. YDG.	C.O.L. SQ. FT.	FABRIC UPHOLSTERY GRADES										LEATHER UPHOLSTERY GRADES								
								A	B	C	D	E	F	G	H	I	J	W	X	Y	E1	E2				
	TALL BACK																									
	IN	4	9	27	00	ARMLESS	2.4	36	1,394	1,494	1,589	1,682	1,776	1,879	1,983	2,101	2,258	2,446	2,225	2,412	2,888	3,331	3,788			
	IN	4	9	27	59	ADJUSTABLE HEIGHT, BLACK, URETHANE CAP	2.4	36	1,609	1,709	1,803	1,895	1,989	2,093	2,196	2,317	2,473	2,658	2,447	2,636	3,115	3,556	4,011			
	IN	4	9	27	69	ADJUSTABLE HEIGHT, CHROME, URETHANE CAP	2.4	36	1,624	1,723	1,817	1,911	2,003	2,110	2,212	2,333	2,489	2,677	2,466	2,655	3,130	3,572	4,027			
	IN	4	9	27	51	FIXED HEIGHT C-ARM, BLACK URETHANE	2.4	36	1,609	1,709	1,803	1,895	1,989	2,093	2,196	2,317	2,473	2,658	2,447	2,636	3,115	3,556	4,011			
	IN	4	9	27	54/64	C-ARM, PAINTED OR POLISHED ALUMINUM	2.4	36	1,779	1,878	1,970	2,066	2,159	2,260	2,365	2,487	2,643	2,830	2,625	2,816	3,290	3,731	4,189			
	IN	4	9	27	55/65	C-ARM, PAINTED OR POLISHED, PLASTIC CAP	2.4	36	1,814	1,916	2,008	2,101	2,196	2,300	2,404	2,523	2,681	2,868	2,665	2,854	3,331	3,772	4,229			
	IN	4	9	27	56/66	C-ARM, PAINTED OR POLISHED, UPHOLSTERED CAP	2.4	36	1,853	1,955	2,047	2,141	2,235	2,337	2,443	2,562	2,717	2,905	2,708	2,893	3,371	3,813	4,269			
	IN	4	9	27	57	FIXED HEIGHT C-ARM, FULLY UPHOLSTERED		44				2,114							3,253	3,512	4,161	4,765	5,388			

TO ORDER FOLLOW STEPS 1-6

1 SERIES/STYLE/SIZE 2 CONTROLS/FUNCTION 3 ARM CHOICES 4 OPTIONS 5 FINISH CHOICES 6 COVER

IN 49 UPHOLSTERED TALL BACK
SEAT: MEDIUM
20.5"W X 19"D
BACK: TALL
28"H X 20.5"W

27 MID PIVOT SYNCHRO TILT
ADJUSTMENTS: PNEUMATIC
SEAT HEIGHT, BACK ANGLE,
TILT TENSION

00 ARMLESS

59 ADJUSTABLE HEIGHT ARM,
BLACK, URETHANE CAP

69 ADJUSTABLE HEIGHT ARM,
CHROME, URETHANE CAP

51 FIXED HEIGHT C-ARM,
BLACK URETHANE

54 FIXED HEIGHT C-ARM,
PAINTED ALUMINUM

64 FIXED HEIGHT C-ARM
POLISHED ALUMINUM

55 FIXED HEIGHT C-ARM,
PAINTED ALUMINUM
WITH PLASTIC CAP

65 FIXED HEIGHT C-ARM,
POLISHED ALUMINUM
WITH PLASTIC CAPS

56 FIXED HEIGHT C-ARM,
PAINTED ALUMINUM
WITH UPHOLSTERED CAP

66 FIXED HEIGHT C-ARM,
POLISHED ALUMINUM
WITH UPHOLSTERED CAP

57 FIXED HEIGHT C-ARM,
UPHOLSTERED

NOTE: COMS, COLS AND
IN-GRADED FABRICS MUST BE
APPROVED SPECIFICALLY FOR
UPHOLSTERED ARM CAPS.

SS SEAT SLIDE +108

R RUBBER TIRED CASTERS +38

GL GLIDE SUBSTITUTION +00

CT CONTRASTING THREAD +00

B22 PAINTED CAST
ALUMINUM BASE
CHOOSE FINISH +00

B23 POLISHED CAST
ALUMINUM BASE +00

B10 PLASTIC BASE
(BLACK MATTE ONLY) -69

CU COORDINATED
UPHOLSTERY* +38

* COORDINATED UPHOLSTERY
THESE CHAIRS MAY BE ORDERED
WITH COORDINATED UPHOL-
STERY, AS OPPOSED TO STAN-
DARD MATCHING UPHOLSTERY,
ON SEATS AND BACKS. PLEASE
CONTACT CUSTOMER SERVICE
FOR DETAILS.

STANDARD POWDER PAINT +00

BM BLACK MATTE (STD)	NY NAVY*
BT BLACK TWILIGHT*	NK NICKEL*
BL BLUE*	OR ORANGE*
BR BRASS*	PY PALE YELLOW*
CP CHAMPAGNE*	RD RED*
DB DARK BRONZE*	RO RED ORANGE*
DG DARK GRAY*	RR RUSTY RED*
DP DUSTY PINK*	SD SAND*
FG FOREST GREEN*	SB SOFT BLUE*
LG LIGHT GRAY*	TC TERRACOTTA*
MG MEADOW GREEN*	TP TAUPE*
MS METALLIC SILVER*	TS TEXTURED SLATE*
MK MILK*	YL YELLOW*

* THE FINISH SELECTION WILL BE APPLIED
TO THE ALUMINUM BASE AND/OR ARMS
PER THE MODEL CODES.

POLISHED ARMS CAN BE ORDERED WITH A
PAINTED BASE OR VICE VERSA BY DESIG-
NATING ONE COMPONENT FOR PAINTED
FINISH AND THE OTHER AS POLISHED.

SEE SWATCH CARDS FOR
STANDARD UPHOLSTERY
OPTIONS.
SEE GENERAL INFORMA-
TION SECTION FOR
DETAILS ON COM AND
IN-GRADED FABRIC
PROGRAM.
SEE GENERAL INFORMA-
TION SECTION FOR CAL
133 INFORMATION.



insight executive fully upholstered swivel

EXECUTIVE CONFERENCE AND DESK

DESCRIPTION

FABRIC
UPHOLSTERY
GRADES

LEATHER UPHOLSTERY
GRADES

SERIES	STYLE	SIZE	CONTROL	ARMS	DESCRIPTION	YDG.	SQ. FT.	FABRIC UPHOLSTERY GRADES												LEATHER UPHOLSTERY GRADES										
								A	B	C	D	E	F	G	H	I	J	W	X	Y	E1	E2								
	MEDIUM BACK		38	00	ARMLESS	2.0	32	1,314	1,401	1,481	1,562	1,644	1,731	1,819	1,926	2,060	2,223	2,021	2,181	2,581	2,956	3,338								
	IN	4		6	59	ADJUSTABLE HEIGHT, BLACK, URETHANE CAP	2.0	32	1,527	1,615	1,695	1,778	1,855	1,947	2,035	2,138	2,274	2,436	2,244	2,405	2,806	3,178	3,563							
	IN	4		6	69	ADJUSTABLE HEIGHT, CHROME, URETHANE CAP	2.0	32	1,527	1,615	1,695	1,778	1,855	1,947	2,035	2,138	2,274	2,436	2,244	2,405	2,806	3,178	3,563							
	IN	4		6	51	FIXED HEIGHT C-ARM, BLACK URETHANE	2.0	32	1,527	1,615	1,695	1,778	1,855	1,947	2,035	2,138	2,274	2,436	2,244	2,405	2,806	3,178	3,563							
	IN	4		6	54/64	C-ARM, PAINTED OR POLISHED ALUMINUM	2.0	32	1,696	1,784	1,864	1,944	2,027	2,116	2,204	2,309	2,444	2,605	2,421	2,581	2,981	3,356	3,739							
	IN	4		6	55/65	C-ARM, PAINTED OR POLISHED, PLASTIC CAP	2.0	32	1,736	1,823	1,901	1,985	2,066	2,156	2,242	2,347	2,480	2,644	2,460	2,621	3,022	3,398	3,780							
	HIGH BACK	4	8	38	00	2.2	35	1,352	1,443	1,527	1,614	1,697	1,792	1,885	1,996	2,137	2,309	2,137	2,320	2,771	3,189	3,621								
								IN	4	8	59	ADJUSTABLE HEIGHT, BLACK, URETHANE CAP	2.2	35	1,565	1,657	1,744	1,828	1,913	2,006	2,098	2,211	2,352	2,522	2,363	2,543	2,995	3,414	3,847	
								IN	4	8	69	ADJUSTABLE HEIGHT, CHROME, URETHANE CAP	2.2	35	1,583	1,674	1,758	1,844	1,928	2,024	2,116	2,227	2,367	2,538	2,378	2,562	3,010	3,430	3,863	
								IN	4	8	51	FIXED HEIGHT C-ARM, BLACK URETHANE	2.2	35	1,565	1,657	1,744	1,828	1,913	2,006	2,098	2,211	2,352	2,522	2,363	2,543	2,995	3,414	3,847	
								IN	4	8	54/64	C-ARM, PAINTED OR POLISHED ALUMINUM	2.2	35	1,736	1,826	1,911	1,996	2,081	2,175	2,270	2,378	2,521	2,691	2,538	2,722	3,173	3,591	4,023	
								IN	4	8	55/65	C-ARM, PAINTED OR POLISHED, PLASTIC CAP	2.2	35	1,774	1,864	1,949	2,035	2,120	2,213	2,308	2,417	2,560	2,729	2,580	2,760	3,212	3,630	4,063	
	HIGH BACK	4	8	38	56/66	2.2	35	1,811	1,901	1,988	2,073	2,159	2,251	2,346	2,455	2,597	2,768	2,620	2,803	3,252	3,672	4,103								
								IN	4	8	57	FIXED HEIGHT C-ARM, FULLY UPHOLSTERED	2.2	35	1,811	1,901	1,988	2,073	2,159	2,251	2,346	2,455	2,597	2,768	2,620	2,803	3,252	3,672	4,103	
								IN	4	8	57	FIXED HEIGHT C-ARM, FULLY UPHOLSTERED	2.2	43				2,070							3,169	3,417	4,042	4,621	5,222	
								IN	4	8	57	FIXED HEIGHT C-ARM, FULLY UPHOLSTERED	2.2	43				2,070								3,169	3,417	4,042	4,621	5,222
								IN	4	8	57	FIXED HEIGHT C-ARM, FULLY UPHOLSTERED	2.2	43				2,070								3,169	3,417	4,042	4,621	5,222
								IN	4	8	57	FIXED HEIGHT C-ARM, FULLY UPHOLSTERED	2.2	43				2,070								3,169	3,417	4,042	4,621	5,222

TO ORDER FOLLOW STEPS 1-6

1 SERIES/STYLE/SIZE 2 CONTROLS/FUNCTION 3 ARM CHOICES 4 OPTIONS 5 FINISH CHOICES 6 COVER

- IN 46** UPHOLSTERED MEDIUM BACK
SEAT: MEDIUM
20.5"W X 19"D
BACK: MEDIUM
20.5"H X 20.5"W
- IN 48** UPHOLSTERED HIGH BACK
SEAT: MEDIUM
20.5"W X 19"D
BACK: HIGH
24"H X 20.5"W

- 38** EXECUTIVE FORWARD PIVOT KNEE TILT
ADJUSTMENTS: PNEUMATIC SEAT HEIGHT, TILT TENSION, MULTI-ANGLE TILT LOCK

- 00** ARMLESS
- 59** ADJUSTABLE HEIGHT ARM, BLACK, URETHANE CAP
- 69** ADJUSTABLE HEIGHT ARM, CHROME, URETHANE CAP
- 51** FIXED HEIGHT C-ARM, BLACK URETHANE
- 54** FIXED HEIGHT C-ARM, PAINTED ALUMINUM
- 64** FIXED HEIGHT C-ARM POLISHED ALUMINUM
- 55** FIXED HEIGHT C-ARM, PAINTED ALUMINUM WITH PLASTIC CAP
- 65** FIXED HEIGHT C-ARM, POLISHED ALUMINUM WITH PLASTIC CAPS
- 56** FIXED HEIGHT C-ARM, PAINTED ALUMINUM WITH UPHOLSTERED CAP
- 66** FIXED HEIGHT C-ARM, POLISHED ALUMINUM WITH UPHOLSTERED CAP
- 57** FIXED HEIGHT C-ARM, UPHOLSTERED

NOTE: COMS, COLS AND IN-GRADED FABRICS MUST BE APPROVED SPECIFICALLY FOR UPHOLSTERED ARM CAPS.

- R** RUBBER TIED CASTERS +38
- GL** GLIDE SUBSTITUTION +00
- CT** CONTRASTING THREAD +00
- B22** PAINTED CAST ALUMINUM BASE CHOOSE FINISH +00
- B23** POLISHED CAST ALUMINUM BASE +00
- B10** PLASTIC BASE (BLACK MATTE ONLY) -69
- CU** COORDINATED UPHOLSTERY* +38

* COORDINATED UPHOLSTERY THESE CHAIRS MAY BE ORDERED WITH COORDINATED UPHOLSTERY, AS OPPOSED TO STANDARD MATCHING UPHOLSTERY, ON SEATS AND BACKS. PLEASE CONTACT CUSTOMER SERVICE FOR DETAILS.

- STANDARD POWDER PAINT +00**
- BM BLACK MATTE (STD)
- BT BLACK TWILIGHT*
- BL BLUE*
- BR BRASS*
- CP CHAMPAGNE*
- DB DARK BRONZE*
- DG DARK GRAY*
- DP DUSTY PINK*
- FG FOREST GREEN*
- LG LIGHT GRAY*
- MG MEADOW GREEN*
- MS METALLIC SILVER*
- MK MILK*
- NY NAVY*
- NK NICKEL*
- OR ORANGE*
- PY PALE YELLOW*
- RD RED*
- RO RED ORANGE*
- RR RUSTY RED*
- SD SAND*
- SB SOFT BLUE*
- TC TERRACOTTA*
- TP TAUPE*
- TS TEXTURED SLATE*
- YL YELLOW*

* THE FINISH SELECTION WILL BE APPLIED TO THE ALUMINUM BASE AND/OR ARMS PER THE MODEL CODES.

POLISHED ARMS CAN BE ORDERED WITH A PAINTED BASE OR VICE VERSA BY DESIGNATING ONE COMPONENT FOR PAINTED FINISH AND THE OTHER AS POLISHED.

SEE SWATCH CARDS FOR STANDARD UPHOLSTERY OPTIONS.
SEE GENERAL INFORMATION SECTION FOR DETAILS ON COM AND IN-GRADED FABRIC PROGRAM.
SEE GENERAL INFORMATION SECTION FOR CAL 133 INFORMATION.



insight executive fully upholstered swivel

EXECUTIVE CONFERENCE AND DESK

DESCRIPTION

FABRIC
UPHOLSTERY
GRADES

LEATHER UPHOLSTERY
GRADES

SERIES	STYLE	SIZE	CONTROL	ARMS	DESCRIPTION	C.O.M. YDG.	C.O.L. SQ.FT.	FABRIC UPHOLSTERY GRADES										LEATHER UPHOLSTERY GRADES						
								A	B	C	D	E	F	G	H	I	J	W	X	Y	E1	E2		
	TALL BACK	IN	4	9	38	00	ARMLESS	2.4	36	1,394	1,494	1,589	1,682	1,776	1,879	1,983	2,101	2,258	2,446	2,225	2,412	2,888	3,331	3,788
		IN	4	9	38	59	ADJUSTABLE HEIGHT, BLACK, URETHANE CAP	2.4	36	1,609	1,709	1,803	1,895	1,989	2,093	2,196	2,317	2,473	2,658	2,447	2,636	3,115	3,556	4,011
		IN	4	9	38	69	ADJUSTABLE HEIGHT, CHROME, URETHANE CAP	2.4	36	1,624	1,723	1,817	1,911	2,003	2,110	2,212	2,333	2,489	2,677	2,466	2,655	3,130	3,572	4,027
		IN	4	9	38	51	FIXED HEIGHT C-ARM, BLACK URETHANE	2.4	36	1,609	1,709	1,803	1,895	1,989	2,093	2,196	2,317	2,473	2,658	2,447	2,636	3,115	3,556	4,011
		IN	4	9	38	54/64	C-ARM, PAINTED OR POLISHED ALUMINUM	2.4	36	1,779	1,878	1,970	2,066	2,159	2,260	2,365	2,487	2,643	2,830	2,625	2,816	3,290	3,731	4,189
		IN	4	9	38	55/65	C-ARM, PAINTED OR POLISHED, PLASTIC CAP	2.4	36	1,814	1,916	2,008	2,101	2,196	2,300	2,404	2,523	2,681	2,868	2,665	2,854	3,331	3,772	4,229
		IN	4	9	38	56/66	C-ARM, PAINTED OR POLISHED, UPHOLSTERED CAP	2.4	36	1,853	1,955	2,047	2,141	2,235	2,337	2,443	2,562	2,717	2,905	2,708	2,893	3,371	3,813	4,269
			IN	4	9	38	57	FIXED HEIGHT C-ARM, FULLY UPHOLSTERED		44				2,114							3,253	3,512	4,161	4,765





TO ORDER FOLLOW STEPS 1-6

1 SERIES/STYLE/SIZE 2 CONTROLS/FUNCTION 3 ARM CHOICES 4 OPTIONS 5 FINISH CHOICES 6 COVER

1 **UPHOLSTERED TALL BACK**
SEAT: MEDIUM
20.5"W X 19"D
BACK: TALL
28"H X 20.5"W

2 **EXECUTIVE FORWARD PIVOT KNEE TILT**
ADJUSTMENTS: PNEUMATIC SEAT HEIGHT, TILT TENSION, MULTI-ANGLE TILT LOCK

3 **ARM CHOICES**

- 00**  ARMLESS
- 59**  ADJUSTABLE HEIGHT ARM, BLACK, URETHANE CAP
- 69**  ADJUSTABLE HEIGHT ARM, CHROME, URETHANE CAP
- 51**  FIXED HEIGHT C-ARM, BLACK URETHANE
- 54**  FIXED HEIGHT C-ARM, PAINTED ALUMINUM

4 **OPTIONS**

- R** RUBBER TIED CASTERS +38
- GL** GLIDE SUBSTITUTION +00
- CT** CONTRASTING THREAD +00
- B22** PAINTED CAST ALUMINUM BASE CHOOSE FINISH +00
- B23** POLISHED CAST ALUMINUM BASE +00
- B10** PLASTIC BASE (BLACK MATTE ONLY) -69
- CU** COORDINATED UPHOLSTERY* +38

* COORDINATED UPHOLSTERY THESE CHAIRS MAY BE ORDERED WITH COORDINATED UPHOLSTERY, AS OPPOSED TO STANDARD MATCHING UPHOLSTERY, ON SEATS AND BACKS. PLEASE CONTACT CUSTOMER SERVICE FOR DETAILS.

5 **FINISH CHOICES**

STANDARD POWDER PAINT +00

BM BLACK MATTE (STD)	NY NAVY*
BT BLACK TWILIGHT*	NK NICKEL*
BL BLUE*	OR ORANGE*
BR BRASS*	PY PALE YELLOW*
CP CHAMPAGNE*	RD RED*
DB DARK BRONZE*	RO RED ORANGE*
DG DARK GRAY*	RR RUSTY RED*
DP DUSTY PINK*	SD SAND*
FG FOREST GREEN*	SB SOFT BLUE*
LG LIGHT GRAY*	TC TERRACOTTA*
MG MEADOW GREEN*	TP TAUPE*
MS METALLIC SILVER*	TS TEXTURED SLATE*
MK MILK*	YL YELLOW*

* THE FINISH SELECTION WILL BE APPLIED TO THE ALUMINUM BASE AND/OR ARMS PER THE MODEL CODES.

POLISHED ARMS CAN BE ORDERED WITH A PAINTED BASE OR VICE VERSA BY DESIGNATING ONE COMPONENT FOR PAINTED FINISH AND THE OTHER AS POLISHED.

6 **COVER**

SEE SWATCH CARDS FOR STANDARD UPHOLSTERY OPTIONS.
SEE GENERAL INFORMATION SECTION FOR DETAILS ON COM AND IN-GRADED FABRIC PROGRAM.
SEE GENERAL INFORMATION SECTION FOR CAL 133 INFORMATION.

stylex

Insight Mesh

PRICE LIST
Effective November 1, 2022

PRODUCT INFORMATION

APPLICATIONS:

EXECUTIVE / CONFERENCE

MEDIUM SEAT
MEDIUM BACK

MEDIUM SEAT
HIGH BACK

DRAFTING
STOOL

DRAFTING
STOOL

GENERAL INFORMATION

DIMENSIONS / OVERVIEW

SIZE 6 MESH BACK

SIZE 8 MESH BACK

INTERMEDIATE HEIGHT

FULL HEIGHT

GENERAL DIMENSIONS

- A. SEAT HEIGHT*
- B. SEAT DEPTH
- C. BACK HEIGHT
- D. SEAT WIDTH & OVERALL WIDTH (ARMLESS)
- E. MAXIMUM OVERALL HEIGHT*

* MEASUREMENTS GIVEN ARE ACCURATE FOR MOST CONTROLS. SPECIFIC MODELS MAY VARY SLIGHTLY.

- A. 17"- 21"
- B. 18"
- C. 20"
- D. 20.5"
- E. 35.5"- 39"

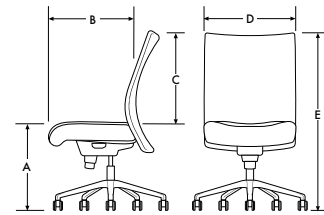

- A. 17"- 21"
- B. 18"
- C. 24"
- D. 20.5"
- E. 39"- 42.5"

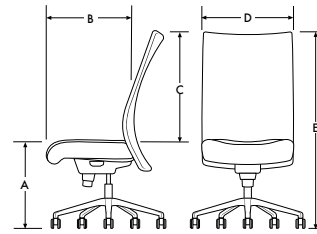

- A. 20.5"-28.5"
- B. 18"
- C. 18"
- D. 20.5"
- E. 46.5"

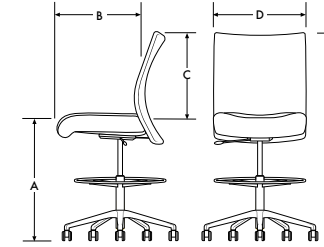

- A. 23.5"-33.5"
- B. 18"
- C. 18"
- D. 20.5"
- E. 51.5"

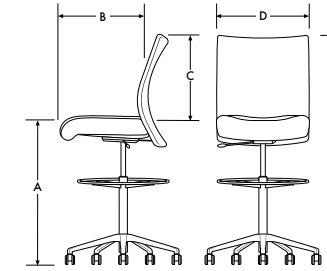

DESIGN
STYLEX

BACK CONSTRUCTION
BACKS CONSIST OF A MESH COVER ENCASING A 5/8" STEEL ROD FRAME THAT HAS BEEN SEALED IN A SOFT PROTECTIVE URETHANE. THE MESH ITSELF IS A KNIT COMBINATION OF POLYESTER AND ELASTOMERIC THREAD.

SEAT CONSTRUCTION
SEATS INCORPORATE COMPOUND CURVE PLYWOOD COVERED WITH CUSHIONS OF CFC-FREE POLYURETHANE.

T-SHAPE ADJUSTABLE ARM OPTION

- A. OVERALL WIDTH
- B. DISTANCE BETWEEN ARMS
- C. ARM HEIGHT

- A. 26"
- B. 19"
- C. 6.5"-9.5"

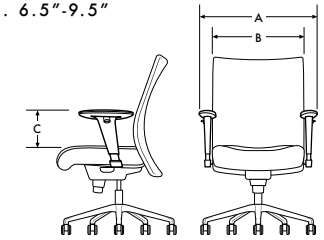

- A. 26"
- B. 19"
- C. 6.5"-9.5"

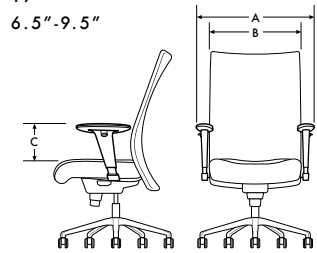

- A. 26"
- B. 19"
- C. 6.5"-9.5"

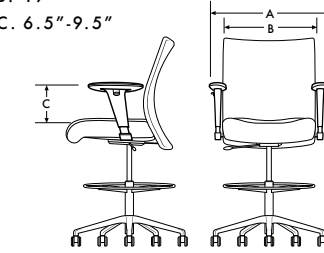

- A. 26"
- B. 19"
- C. 6.5"-9.5"

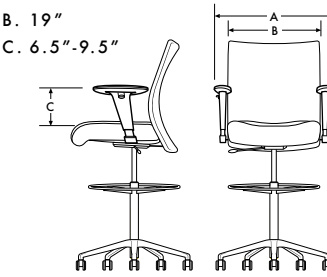

ARMS

HEIGHT-ADJUSTABLE ARMS HAVE PADS MADE FROM SELF-SKINNED URETHANE OVER A STEEL FRAME. FIXED HEIGHT CANTILEVER ARMS MAY BE BLACK POLYURETHANE, UPHOLSTERED, OR CAST ALUMINUM. ALUMINUM ARMS MAY BE POLISHED OR PAINTED WITH OR WITHOUT CAPS. CAPS MAY BE UPHOLSTERED OR BLACK PLASTIC.

BASES

THE STANDARD FIVE PRONG BASE IS BLACK, GLASS-FILLED NYLON. AN OPTIONAL CAST ALUMINUM BASE IS AVAILABLE EITHER WITH HIGHLY POLISHED FINISH OR A CHOICE OF POWDER COAT FINISHES.

CASTERS

OPTIONAL RUBBER-TIRED CASTERS MUST BE USED ON HARD FLOORS SUCH AS WOOD, LINOLEUM OR CONCRETE. PLEASE BE SURE TO SPECIFY RUBBER-TIRED CASTERS FOR THESE APPLICATIONS.

TESTING

MANUFACTURED TO COMPLY WITH ANSI/BIFMA X5.1 GENERAL OFFICE CHAIR TESTS.

ENVIRONMENT

GREENGUARD CERTIFIED.

CANTILEVERED FIXED ARM OPTION

- A. OVERALL WIDTH
- B. DISTANCE BETWEEN ARMS
- C. ARM HEIGHT

- A. 25"
- B. 21"
- C. 8.5"

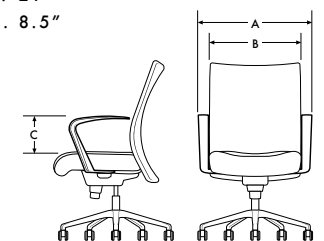

- A. 25"
- B. 21"
- C. 8.5"

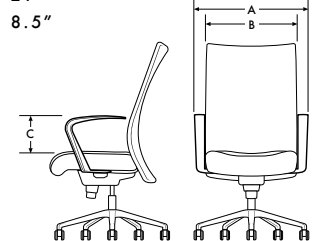

- A. 25"
- B. 21"
- C. 8.5"

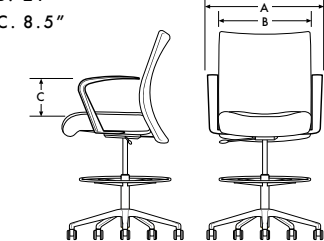

- A. 25"
- B. 21"
- C. 8.5"

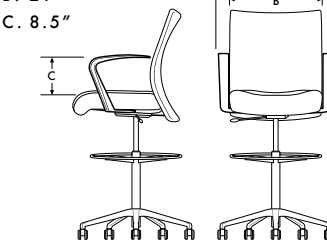

DESCRIPTION

C.O.M.











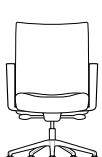

C.O.L.

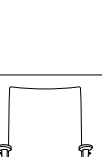
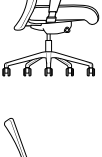
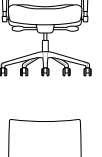
FABRIC
UPHOLSTERY
GRADES

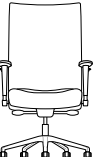
C.O.M.

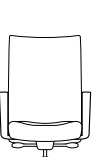
C.O.L.

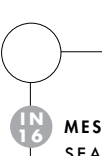
LEATHER UPHOLSTERY
GRADES

SERIES	STYLE	SIZE	CONTROL	ARMS	YDG.	SQ.FT.	A	B	C	D	E	F	G	H	I	J	W	X	Y	E1	E2		
MEDIUM BACK																							
	IN	1	6	27	00	ARMLESS	.75	10	1,005	1,041	1,077	1,109	1,147	1,180	1,218	1,265	1,306	1,353	1,207	1,252	1,485	1,523	1,733
	IN	1	6	27	59	ADJUSTABLE HEIGHT, BLACK, URETHANE CAP	.75	10	1,213	1,247	1,282	1,315	1,352	1,388	1,425	1,468	1,512	1,558	1,413	1,458	1,701	1,729	1,952
	IN	1	6	27	69	ADJUSTABLE HEIGHT, CHROME, URETHANE CAP	.75	10	1,228	1,265	1,297	1,332	1,367	1,401	1,439	1,484	1,526	1,572	1,427	1,471	1,717	1,745	1,967
	IN	1	6	27	51	FIXED HEIGHT C-ARM, BLACK URETHANE	.75	10	1,213	1,247	1,282	1,315	1,352	1,388	1,425	1,468	1,512	1,558	1,413	1,458	1,701	1,729	1,952
	IN	1	6	27	54/64	C-ARM, PAINTED OR POLISHED ALUMINUM	.75	10	1,373	1,410	1,444	1,477	1,515	1,550	1,588	1,631	1,672	1,720	1,572	1,620	1,872	1,891	2,122
	IN	1	6	27	55/65	C-ARM, PAINTED OR POLISHED, PLASTIC CAP	.75	10	1,412	1,446	1,481	1,516	1,551	1,588	1,624	1,666	1,711	1,759	1,609	1,656	1,911	1,928	2,160
	IN	1	6	27	56/66	C-ARM, PAINTED OR POLISHED, UPHOLSTERED CAP	.75	10	1,447	1,484	1,517	1,552	1,589	1,624	1,659	1,703	1,747	1,794	1,647	1,692	1,948	1,965	2,198
	IN	1	6	27	57	FIXED HEIGHT C-ARM, FULLY UPHOLSTERED		21				1,636							1,918	2,003	2,581	2,713	3,136
HIGH BACK																							
	IN	1	8	27	00	ARMLESS	.75	10	1,056	1,093	1,126	1,164	1,199	1,233	1,270	1,313	1,356	1,404	1,257	1,304	1,539	1,575	1,790
	IN	1	8	27	59	ADJUSTABLE HEIGHT, BLACK, URETHANE CAP	.75	10	1,266	1,299	1,333	1,368	1,403	1,439	1,475	1,520	1,561	1,609	1,463	1,511	1,756	1,781	2,007
	IN	1	8	27	69	ADJUSTABLE HEIGHT, CHROME, URETHANE CAP	.75	10	1,279	1,313	1,348	1,383	1,418	1,455	1,489	1,534	1,578	1,628	1,477	1,523	1,770	1,794	2,019
	IN	1	8	27	51	FIXED HEIGHT C-ARM, BLACK URETHANE	.75	10	1,266	1,299	1,333	1,368	1,403	1,439	1,475	1,520	1,561	1,609	1,463	1,511	1,756	1,781	2,007
	IN	1	8	27	54/64	C-ARM, PAINTED OR POLISHED ALUMINUM	.75	10	1,426	1,460	1,494	1,529	1,564	1,599	1,636	1,680	1,724	1,772	1,628	1,671	1,923	1,943	2,173
	IN	1	8	27	55/65	C-ARM, PAINTED OR POLISHED, PLASTIC CAP	.75	10	1,462	1,497	1,530	1,565	1,601	1,636	1,675	1,718	1,761	1,810	1,663	1,710	1,963	1,979	2,212
	IN	1	8	27	56/66	C-ARM, PAINTED OR POLISHED, UPHOLSTERED CAP	.75	10	1,498	1,534	1,566	1,602	1,637	1,675	1,712	1,755	1,797	1,847	1,697	1,745	2,002	2,015	2,252
	IN	1	8	27	57	FIXED HEIGHT C-ARM, FULLY UPHOLSTERED		21				1,689							1,968	2,056	2,636	2,764	3,191

TO ORDER FOLLOW STEPS 1-7

1 SERIES/STYLE/SIZE 2 CONTROLS/FUNCTION 3 ARM CHOICES 4 MESH 5 OPTIONS 6 FINISH CHOICES 7 COVER

IN 16 MESH MEDIUM BACK
SEAT: MEDIUM
20.5"W X 18.5"D
BACK: MEDIUM
20"H X 20.5"W

IN 18 MESH HIGH BACK
SEAT: MEDIUM
20.5"W X 18.5"D
BACK: HIGH
24"H X 20.5"W

27 MID PIVOT SYNCHRO TILT
ADJUSTMENTS: PNEUMATIC
SEAT HEIGHT, BACK ANGLE,
TILT TENSION
• OPTIONAL SEAT SLIDE

00 ARMLESS

59 ADJUSTABLE HEIGHT ARM,
BLACK, URETHANE CAP

69 ADJUSTABLE HEIGHT ARM,
CHROME, URETHANE CAP

51 FIXED HEIGHT C-ARM,
BLACK URETHANE

54 FIXED HEIGHT C-ARM,
PAINTED ALUMINUM

64 FIXED HEIGHT C-ARM
POLISHED ALUMINUM

55 FIXED HEIGHT C-ARM,
PAINTED ALUMINUM
WITH PLASTIC CAP

65 FIXED HEIGHT C-ARM,
POLISHED ALUMINUM
WITH PLASTIC CAPS

56 FIXED HEIGHT C-ARM,
PAINTED ALUMINUM
WITH UPHOLSTERED CAP

66 FIXED HEIGHT C-ARM,
POLISHED ALUMINUM
WITH UPHOLSTERED CAP

57 FIXED HEIGHT C-ARM,
UPHOLSTERED

NOTE: COMS, COLS AND
IN-GRADED FABRICS MUST BE
APPROVED SPECIFICALLY FOR
UPHOLSTERED ARM CAPS.

MESH

30 ANTHRACITE
31 MUSHROOM
32 ZINC
33 JAVA
34 BLACK ICE
35 CAMEL
36 MARINE
38 SILVER ICE

55 SEAT SLIDE +108

R RUBBER TIERED CASTERS +38

GL GLIDE SUBSTITUTION +00

CT CONTRASTING THREAD +00

B22 PAINTED CAST
ALUMINUM BASE
CHOOSE FINISH +82

B23 POLISHED CAST
ALUMINUM BASE +82

BG BUMPER GUARDS
RECOMMENDED FOR
WORKSTATION USE +25

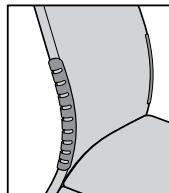

STANDARD POWDER PAINT +00

BM BLACK MATTE (STD)	NY NAVY*
BT BLACK TWILIGHT*	NK NICKEL*
BL BLUE*	OR ORANGE*
BR BRASS*	PY PALE YELLOW*
CP CHAMPAGNE*	RD RED*
DB DARK BRONZE*	RO RED ORANGE*
DG DARK GRAY*	RR RUSTY RED*
DP DUSTY PINK*	SD SAND*
FG FOREST GREEN*	SB SOFT BLUE*
LG LIGHT GRAY*	TC TERRACOTTA*
MG MEADOW GREEN*	TP TAUPE*
MS METALLIC SILVER*	TS TEXTURED SLATE*
MK MILK*	YL YELLOW*

* THE FINISH SELECTION WILL BE APPLIED TO THE ALUMINUM BASE AND/OR ARMS PER THE MODEL CODES.

POLISHED ARMS CAN BE ORDERED WITH A PAINTED BASE OR VICE VERSA BY DESIGNATING ONE COMPONENT FOR PAINTED FINISH AND THE OTHER AS POLISHED.

SEE SWATCH CARDS FOR STANDARD UPHOLSTERY OPTIONS.

SEE GENERAL INFORMATION SECTION FOR DETAILS ON COM AND IN-GRADED FABRIC PROGRAM.

SEE GENERAL INFORMATION SECTION FOR CAL 133 INFORMATION.

DESCRIPTION

C.O.M.
C.O.L.





C.O.M.
C.O.L.

FABRIC
UPHOLSTERY
GRADES

C.O.M.
C.O.L.

C.O.L.

LEATHER UPHOLSTERY
GRADES

SERIES STYLE SIZE CONTROL CYLINDER ARMS								YDG.SQ.FT.		FABRIC UPHOLSTERY GRADES										LEATHER UPHOLSTERY GRADES						
										A	B	C	D	E	F	G	H	I	J	W	X	Y	E1	E2		
INTERMEDIATE DRAFTING HEIGHT																										
		IN	1	5	61	M	00	ARMLESS	.75	10	928	963	997	1,034	1,066	1,104	1,139	1,184	1,228	1,274	1,148	1,202	1,403	1,445	1,652	
		IN	1	5	61	M	59	ADJUSTABLE HEIGHT, BLACK, URETHANE CAP	.75	10	1,135	1,170	1,204	1,239	1,273	1,310	1,347	1,391	1,431	1,483	1,353	1,409	1,619	1,651	1,871	
		IN	1	5	61	M	69	ADJUSTABLE HEIGHT, CHROME, URETHANE CAP	.75	10	1,149	1,184	1,218	1,253	1,287	1,325	1,360	1,404	1,447	1,496	1,366	1,423	1,634	1,664	1,884	
		IN	1	5	61	M	51	FIXED HEIGHT C-ARM, BLACK URETHANE	.75	10	1,135	1,170	1,204	1,239	1,273	1,310	1,347	1,391	1,431	1,483	1,353	1,409	1,619	1,651	1,871	
		IN	1	5	61	M	54/64	C-ARM, PAINTED OR POLISHED ALUMINUM	.75	10	1,297	1,332	1,365	1,400	1,434	1,470	1,507	1,552	1,594	1,644	1,517	1,571	1,791	1,814	2,040	
		IN	1	5	61	M	55/65	C-ARM, PAINTED OR POLISHED, PLASTIC CAP	.75	10	1,333	1,368	1,401	1,435	1,471	1,507	1,547	1,590	1,632	1,679	1,552	1,607	1,827	1,850	2,079	
		IN	1	5	61	M	56/66	C-ARM, PAINTED OR POLISHED, UPHOLSTERED CAP	.75	10	1,369	1,404	1,439	1,473	1,511	1,547	1,584	1,628	1,668	1,717	1,645	1,698	1,923	1,943	2,173	
		IN	1	5	61	M	57	FIXED HEIGHT C-ARM, FULLY UPHOLSTERED		21			1,558								1,980	2,096	2,505	2,638	3,059	
FULL DRAFTING HEIGHT																										
		IN	1	5	61	H	00	ARMLESS	.75	10	930	966	1,000	1,037	1,074	1,106	1,143	1,186	1,230	1,279	1,150	1,205	1,405	1,447	1,656	
		IN	1	5	61	H	59	ADJUSTABLE HEIGHT, BLACK, URETHANE CAP	.75	10	1,137	1,172	1,207	1,241	1,278	1,312	1,350	1,394	1,434	1,485	1,356	1,412	1,622	1,653	1,873	
		IN	1	5	61	H	69	ADJUSTABLE HEIGHT, CHROME, URETHANE CAP	.75	10	1,151	1,186	1,220	1,256	1,292	1,327	1,362	1,409	1,453	1,498	1,368	1,426	1,636	1,666	1,886	
		IN	1	5	61	H	51	FIXED HEIGHT C-ARM, BLACK URETHANE	.75	10	1,137	1,172	1,207	1,241	1,278	1,312	1,350	1,394	1,434	1,485	1,356	1,412	1,622	1,653	1,873	
		IN	1	5	61	H	54/64	C-ARM, PAINTED OR POLISHED ALUMINUM	.75	10	1,299	1,335	1,368	1,403	1,439	1,473	1,512	1,555	1,597	1,646	1,520	1,575	1,793	1,818	2,042	
		IN	1	5	61	H	55/65	C-ARM, PAINTED OR POLISHED, PLASTIC CAP	.75	10	1,336	1,371	1,404	1,441	1,475	1,512	1,549	1,592	1,634	1,682	1,555	1,610	1,832	1,852	2,081	
		IN	1	5	61	H	56/66	C-ARM, PAINTED OR POLISHED, UPHOLSTERED CAP	.75	10	1,372	1,409	1,443	1,476	1,513	1,549	1,587	1,630	1,671	1,719	1,592	1,648	1,871	1,890	2,120	
		IN	1	5	61	H	57	FIXED HEIGHT C-ARM, FULLY UPHOLSTERED		21			1,561								1,983	2,098	2,507	2,641	3,061	

TO ORDER FOLLOW STEPS 1-8

1 SERIES/STYLE/SIZE 2 CONTROLS/FUNCTION CYLINDER 3 ARM CHOICES 4 MESH 5 OPTIONS 6 FINISH CHOICES 7 COVER

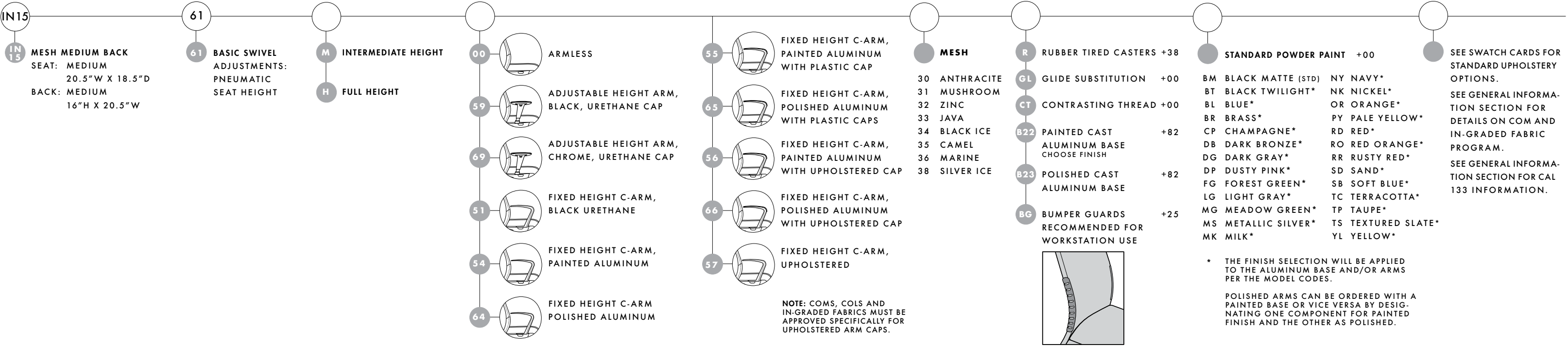

stylex

Luna

PRICE LIST
Effective October 16, 2023

General Information

GENERAL INFORMATION

Terms

Net 30 days from date of invoice.
FOB Delanco, NJ

Damaged Shipments

All Stylex products are carefully inspected before they are packed in sturdy cartons designed to satisfy shipping requirements. Stylex is not responsible for damage in shipment. The transportation company assumes responsibility for delivering products to you in good condition when the bill of lading is signed. You protect yourself by refusing shipments showing damage or shortage until transportation company has noted on the delivery sheet the extent of damage or shortage. Concealed damage should be reported to the carrier as soon as discovered, but not later than 15 days after receiving shipment.

Return/Restocking Policy

Return shipments will not be accepted unless specifically authorized by Stylex in writing. The Return Authorization number should be clearly marked on the carton. The customer returning Stylex products is responsible for return shipping costs. Merchandise must be returned unused. Returned merchandise is subject to a 35% restocking fee.

Specials/Customs

Modifications to standard products will be considered for large runs. Contact Stylex for more information.

Design Changes

In keeping with modern manufacturing advances, Stylex reserves the right to incorporate minor modifications and design changes in products without notice.

Cancellation Policy

No charge prior to production except for inventory specifically requisitioned to fulfill the particular order. After production has begun, only actual costs incurred, including labor and material, will be billed to the customer.

WARRANTY

Except as provided below, Stylex warrants exclusively to the original Purchaser of our product that all parts, under normal use and service, will be free from defects in workmanship and material for a period of ten (10) years from the date of purchase. "Normal use and service" means that the product will be used in a typical office environment for 40-45 hours per week.

This warranty is subject to the following limitations, exclusions and provisions:

Wood components of plywood stacking chairs
(such as Brooks and Welcome)
5 years

Upholstery
(including mesh used for Click, F4, Insight, and Zephyr Mesh)
3 years

SAVA Mesh
10 years

COM Upholstery
No warranty
Stylex makes every effort to ensure that the COM Upholstery it approves is suitable for the intended use. Nevertheless, we will not warrant, and assume no responsibility for, the durability or tailoring quality of any COM or COL. If you have any concerns about the ultimate appearance of any covering, please order an upholstered sample.

Painted Stack Chair Frames
No Warranty
We will not warrant the finish of painted stack chair frames against damage from stacking. We recommend ordering chrome frames for chairs that will be stacked.

Felt Glides
No warranty
Due to the different surfaces on which felt glides may be used, we cannot warrant their durability over time.

If this product fails during normal use and service within the applicable warranty period (other than through normal wear and tear), please send a description of the relevant part and the nature of the defect, together with proof of purchase of the product, to Stylex at: Customer Service. c/o Stylex, P.O. Box 5038, Delanco, NJ 08075. PLEASE DO NOT RETURN PARTS OR THE PRODUCT TO STYLEX UNLESS INSTRUCTED TO DO SO BY STYLEX. Stylex will, at its option, either repair or replace the product or the part found defective by Stylex completely without charge for materials or labor. Purchaser may be required (at the option of Stylex) to return to Stylex at Purchaser's expense any defective part with all freight or shipping charges prepaid. The foregoing warranty shall be void if the product has been altered or repaired (other than by Stylex). The warranty does not cover damage to the product caused by accident, neglect, misuse, abuse, modification to the product by anyone other than Stylex or damage caused by use of the product for a purpose other than that for which it was designed. This warranty extends only to the original Purchaser of the product.

No Other Warranties

This warranty is in lieu of all other warranties, expressed or implied, including, but not limited to, implied warranties of merchantability and fitness for a particular purpose. The rights and remedies provided herein are the exclusive rights and remedies of the original purchaser of the product.

No Liability For Damages

In no event shall Stylex or its suppliers be responsible or liable for any special, indirect, consequential, or incidental damages. In no event shall the liability of Stylex exceed the actual purchase price paid to Stylex for the product.

Out of Warranty Products

For all products no longer covered by our warranty, please refer to our Design for Durability and Upgradability Policy. Contact Customer Service if you would like to purchase any replaceable components to further extend the life of any Stylex seating product. This warranty applies to all Stylex products purchased on April 13, 2018, and thereafter.

PRODUCT TAKE BACK PROGRAM

At Stylex, responsible stewardship of our products extends beyond their initial use. Our Product Take Back Program provides a practical solution for the end of our products' intended life cycle.

Through our partnership with ANEW, a 501(c)(3) nonprofit organization, we offer clients a comprehensive take-back solution for surplus office furniture and materials, regardless of their condition. ANEW's mission aligns with ours—to connect surplus resources with non-profits, public agencies, and underserved communities, minimizing landfill impact and maximizing corporate social responsibility.

By repurposing surplus items, we strengthen community networks and reduce environmental impact. Stylex proudly supports ANEW, integrating this partnership into our strategic sales strategy since 2014. Learn more at www.aneufound.org.

Initiate a Product Take Back through ANEW by emailing Stylex at info@stylexdesign.com. For additional end-of-life recovery options, refer to our Product Disassembly Instructions and End of Life Recovery Options documents, available in the Resources section of each product on our website. Together, let's build a sustainable future.

FREIGHT PROGRAM

Stylex offers a Guaranteed Freight Program, which provides the purchaser the ability to determine shipping and handling charges at the time of order. Freight charges will be calculated as a percentage of the net product price and added to the invoice at the time of shipment. The continental United States has been divided into three zones. Please use the map below to determine the freight charges for the product's destination. There is a minimum freight charge of \$150.

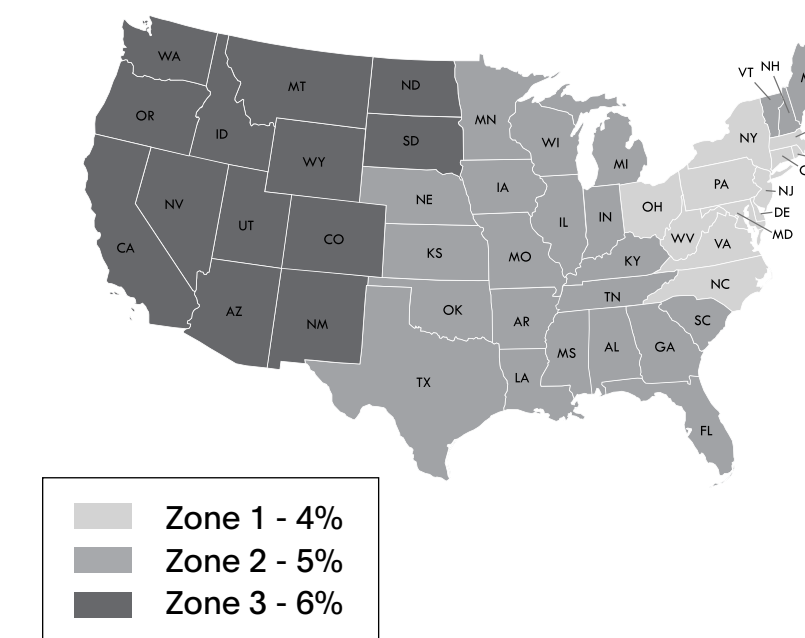

ZONE 1 - 4%

Connecticut
Delaware
New York
New Jersey
Maryland
Massachusetts
North Carolina
Ohio
Pennsylvania
Rhode Island
Virginia
Washington D.C.
West Virginia

ZONE 2 - 5%

Alabama
Arkansas
Canada, Ontario
Canada, Quebec
Florida
Georgia
Iowa
Illinois
Indiana
Kansas
Kentucky
Louisiana
Nebraska
New Hampshire
Oklahoma
Maine
Michigan
Minnesota
Missouri
Mississippi
South Carolina
Tennessee
Texas
Vermont
Wisconsin

ZONE 3 - 6%

Arizona
California
Colorado
Idaho
Montana
Nevada
New Mexico
North Dakota
Oregon
South Dakota
Utah
Washington
Wyoming

Quote Per Project

Alaska
Hawaii
Canada
(outside Ontario & Quebec)
Mexico

General Information

TEXTILE PARTNERS & APPROVALS

Textile Partners

To customize your furniture performance needs and design vision, Stylex offers a wide selection of in-graded leathers and textiles from Grades A through Y. We've partnered with leading manufacturers on the options, focusing on color, price, durability, and construction. To view our partners and explore our digital carded program with broadly approved textiles, visit [this page](#). We stand by these textiles: They're tried and tested, and will effortlessly fit into any design aesthetic.

Textile Approvals

To view Stylex Approved Textile documents to determine specific product approval status, refer to our Product Tested Textiles documents, available in the Resources section of each product on our website.

CAL 117 AND 133 COMPLIANCE

CAL 117-2013

All Stylex seating satisfies the requirements of CAL 117-2013 so long as one of our standard or in-graded textiles is applied. COM textiles cannot be so guaranteed. Please contact the supplier of COM's directly to determine the fire retardancy of any COM supplied to us.

CAL 133

Most Stylex seating can be ordered to meet the requirements of CAL 133. When ordering, simply specify "CAL 133 compliance required". The upcharge for this option is \$54 list per yard. Please refer to the COM yardage of each model to determine the number of yards required. We do frequently require full-scale burn tests in order to certify CAL 133 before an order will be accepted. Such burn tests may increase normal lead times and do carry additional charges. Please contact customer service for details.

CUSTOMER'S OWN MATERIAL/LEATHER

Customer's own material (COM) and customer's own leather (COL) will generally be upholstered at the price designated in each product's price list. Please be advised, however, that we specifically reserve the right to charge a higher price when we determine that special circumstances, such as unusual repeats or challenging materials, present themselves. All orders for custom coverings must be approved by Stylex before they will be accepted for production. To submit proposed textile for approval, please use the COM form [here](#).

Special Note:

We assume no responsibility for the durability or tailoring quality of any COM or COL. Directional covers in particular may not meet your satisfaction due to the design of certain products. Please be advised that COM and COL orders are not subject to return. If you have doubts about the ultimate appearance of certain coverings, please order a sample done with that specific COM or COL. In addition, while we inspect textiles for mill imperfections, some are difficult to recognize. We cannot be responsible for defects, color inaccuracies, dye lot variations, or other flaws.

Under no circumstances will we be responsible for COM shortages, flaws, or other such problems. Finally, it is not our responsibility to police the receipt of COM's in order to meet delivery deadlines, and we assume our customers are aware of any undue delay in the shipment of their COM textiles.

COM textile and COL leather should be sent prepaid to: Stylex

**Attn: COM/COL - [Your PO #]
740 Coopertown Road
Delanco, NJ 08075**

Clearly mark textile or leather with the dealer's name, purchase order number, and furniture model number of the item to be covered. Actual furniture orders should include the same information, as well as a description of the textile or leather, including pattern and color number, in order to provide a cross reference.

Yardage requirements shown in the price list are based on non-directional goods of 54" width. Textiles less than 54" wide or those requiring matching (stripes, prints, or large patterned designs) call for additional yardage. We will be happy to supply yardage requirements for large quantities where economies may be realized.

Add the following yardage for stripes, plaids, or patterns with repeats:

Textile Width	Plain Textile	2-14" Repeat	15-24" Repeat	25-27" Repeat	28-36" Repeat
54"	0%	10%	15%	20%	25%
50"	10%	20%	25%	30%	35%
48"	15%	25%	30%	35%	40%
45"	40%	50%	55%	60%	65%
36"	50%	60%	65%	70%	75%

COM/COL FORM

To avoid delay in processing COM orders we request that you submit a sample of your COM textile stapled to this form which can be downloaded [here](#). If a textile has a stripe or design, the size of the repeat should be indicated. Please indicate the textile supplier's name, textile number, and color. Also indicate the Stylex product on which the textile will be used.

The textile supplier must indicate on his shipping labels the dealer name and purchase order number as well as the Stylex model number.

Please Note:

No order may be entered into production or have a shipping date assigned until all related COM is received at the factory.



CENTER OF STRIPE OR DESIGN

TOP	TOP
-----	-----

1. Size of Repeat

2. Textile Supplier

3. Textile Number

4. Color

5. Stylex Product

Luna

Contents

ABOUT	5	SEATING: ELEVATED	17
STATEMENT OF LINE	6	SEATING: PLINTH	25
PRODUCT INFORMATION	10	TRAY TABLE	33
DIMENSIONS	11	TABLET ARM	34
HOW TO ORDER	13	PLANTER	36
COLORS, MATERIALS, AND FINISHES	16		

CLICK THE TITLES ABOVE TO NAVIGATE THROUGH THE DOCUMENT
PRODUCT HEADERS ON SUBSEQUENT PAGES LINK BACK TO THIS PAGE

Luna

ABOUT

Introducing Luna, banquette seating that offers precise customization down to the inch, ensuring a perfect fit even in the most unconventional spaces. With segments ranging from 25" to 60", Luna allows you to create symmetrical and tailored seating arrangements, whether running or stand alone, with the option for half-moon-shaped arms. Luna seamlessly integrates with our Still screens, and the collection includes options for high or low backs, a planter for enclosed layouts, and a trio of accessory tables. Pricing is offered in seven different buckets, conveniently divided into 5" increments, ensuring efficiency and ease in specification. For layout assistance, our Design Application team is at your service – get in touch at designapplication@stylexdesign.com.



ELEVATED, LOW BACK



PLINTH, HIGH BACK, PLANTERS

Luna

SPECIFICATION GUIDE: STATEMENT OF LINE, ELEVATED SEATING

OVERVIEW

Elevated Low Back	Standard	Arm Left	Arm Right	Arm Both	Armless End Left	Armless End Right
	Round Inside Corner	Square Inside Corner	Round Outside Corner	Round End Cap		
Elevated High Back	Standard	Arm Left	Arm Right	Arm Both	Armless End Left	Armless End Right
	Round Inside Corner	Square Inside Corner	Round Outside Corner	Round End Cap		

PRODUCT INFORMATION

Design

A Stylex Design, by Anthony Land

Legs (Elevated)

Elevated units come with cast aluminum legs, available in a polished finish and Stylex's standard powder coat colors. They can also be ordered without legs for custom millwork.

Configuration

Luna can be ordered as freestanding units or as part of a larger layout. When ordering, it's crucial to specify whether each line item is freestanding or for the start/mid/end of a layout. Arrange them from left to right as viewed from a seated perspective. We highly recommend using CET Designer for specifying this product for optimal accuracy.

Use

Designed for indoor use only.

Performance Standards

Manufactured to comply with:
ANSI/BIFMA X5.4 Lounge Seating Tests (Anticipated Q4 2023)

Certifications

GREENGUARD Gold (Anticipated Q4 2023)
BIFMA LEVEL® 1 Certified (Anticipated Q4 2023)

Luna

SPECIFICATION GUIDE: STATEMENT OF LINE, PLINTH SEATING

OVERVIEW						
Plinth Low Back	Standard	Arm Left	Arm Right	Arm Both	Armless End Left	Armless End Right
	Round Inside Corner	Square Inside Corner	Round Outside Corner	Round End Cap		
Plinth High Back	Standard	Arm Left	Arm Right	Arm Both	Armless End Left	Armless End Right
	Round Inside Corner	Square Inside Corner	Round Outside Corner	Round End Cap		

PRODUCT INFORMATION

Design

A Stylex Design, by Anthony Land

Toe Kick (Plinth)

Plinth units include a 2.625" black laminate toe kick.

Configuration

Luna can be ordered as freestanding units or as part of a larger layout. When ordering, it's crucial to specify whether each line item is freestanding or for the start/mid/end of a layout. Arrange them from left to right as viewed from a seated perspective. We highly recommend using CET Designer for specifying this product for optimal accuracy.

Use

Designed for indoor use only.

Performance Standards

Manufactured to comply with:
ANSI/BIFMA X5.4 Lounge Seating Tests (Anticipated Q4 2023)

Certifications

GREENGUARD GOLD (Anticipated Q4 2023)
LEVEL® 1 (Anticipated Q4 2023)

Luna

SPECIFICATION GUIDE: STATEMENT OF LINE, PLANTERS, TRAYS AND TABLET ARMS

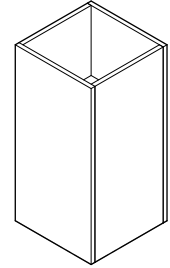
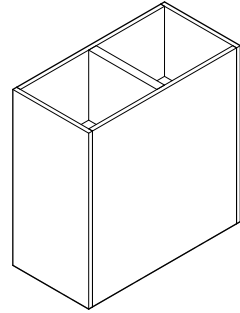
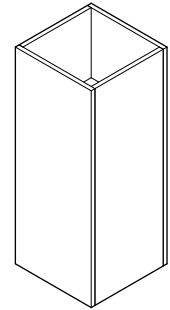
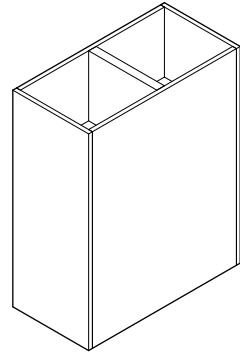
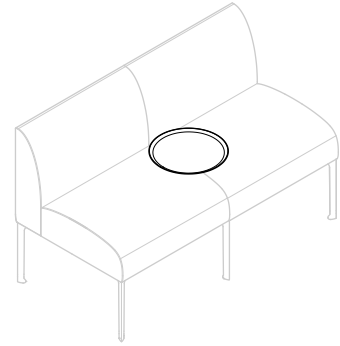
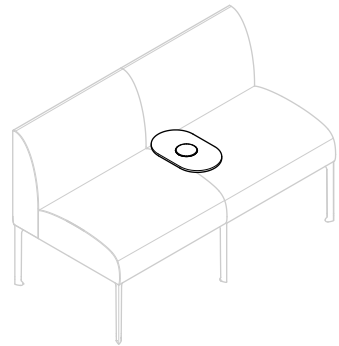
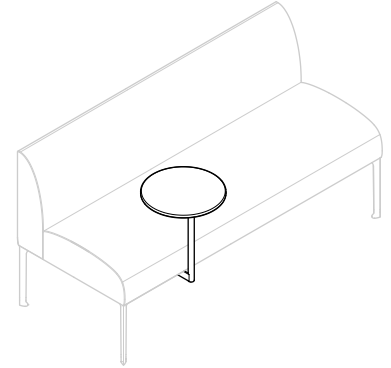
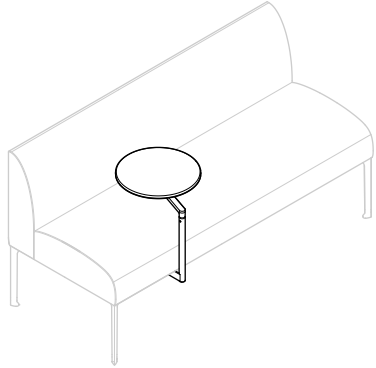
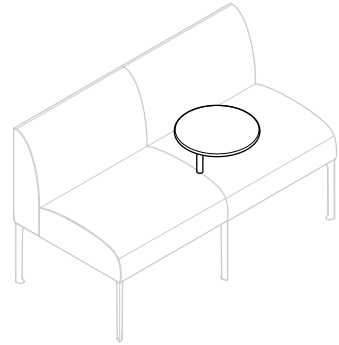
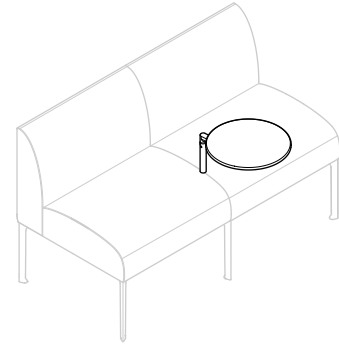
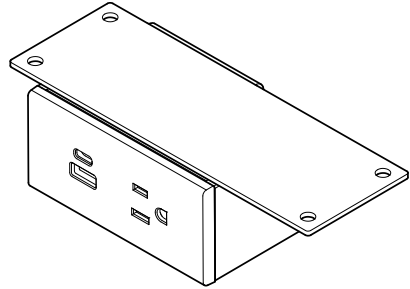
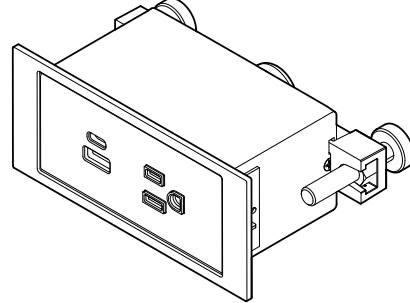
OVERVIEW						
Planter Low Back Height	Single 	Double 				
Planter High Back Height	Single 	Double 				
Tray & Tablet Arm	Round Tray Table 	Wireless Charging Tray 	Under Mount, Single Swivel 	Under Mount, Dual Swivel 	Seat Mount, Single Swivel 	Seat Mount, Dual Swivel 
Power	Under Mount (for Elevated style) 	Flush Mount (for Plinth style) 				

PRODUCT INFORMATION

Planters

Planters extend to the floor, resting on height-adjustable glides, and feature a black laminate finish over an MDF core. They are concealed on all vertical sides by seat units or a wall. Please note that enclosed planters are not intended to be exposed; they should be surrounded by seating units or placed against a wall. Exposed planters will be available in Q2 2024.

Tray Tables and Tablet Arms

The round tray table is made of steel and available in 26 powder coat finishes.

The wireless charging tray comes in four different solid wood finish options, featuring a black wireless surface mount charging unit in the center of the oval top.

Tablet arms are available in single or dual swivel, with four solid wood finish options.

Power

Elevated units offer undermount power beneath the seats, while plinth units offer flush mount power in the front. You can specify power units to be hardwired or equipped with a 3-prong plug. These units feature one USB-A port, one USB-C port, and a standard grounded 3-prong electrical outlet. Additional power options include daisy chain and wireless surface mount charging. Default cord lengths are 10 feet, with custom lengths available. Power units come with wire management clips for every 1-foot length of cord. Daisy chain infeeds are offered in 5', 10', and 15' standard lengths.

Use

Designed for indoor use only.

Performance Standards





Manufactured to comply with:
ANSI/BIFMA X5.4 Lounge Seating Tests (Anticipated Q4 2023)

Certifications

GREENGUARD GOLD (Anticipated Q4 2023)
LEVEL® 1 (Anticipated Q4 2023)

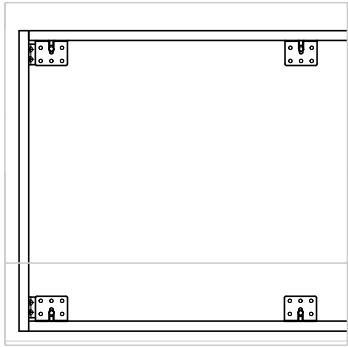
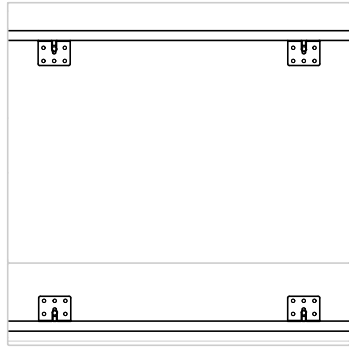
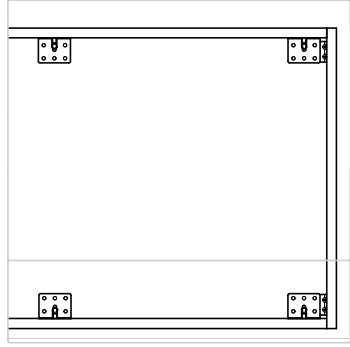
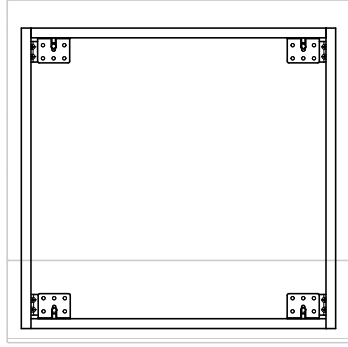
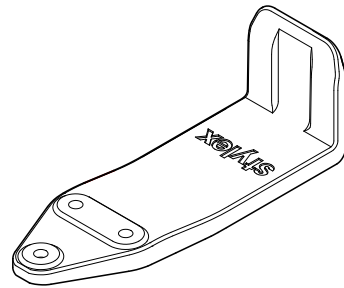
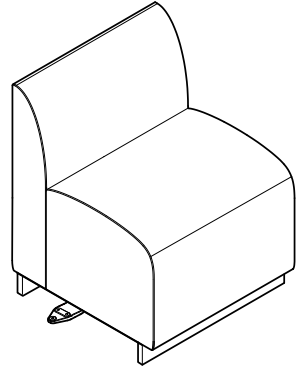
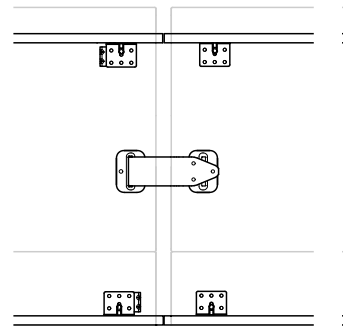
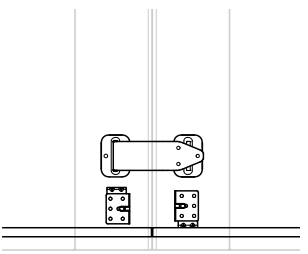
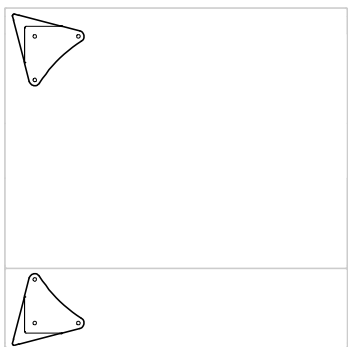
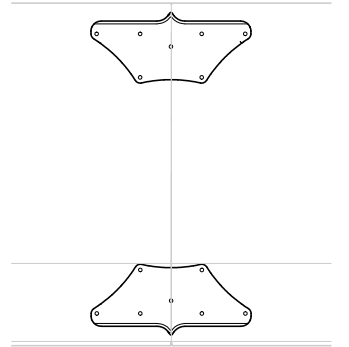
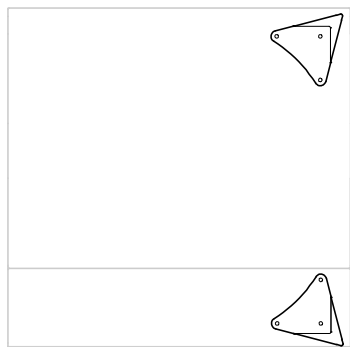
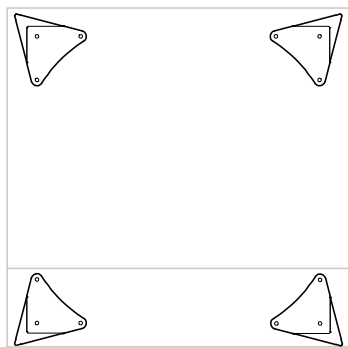
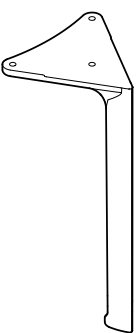
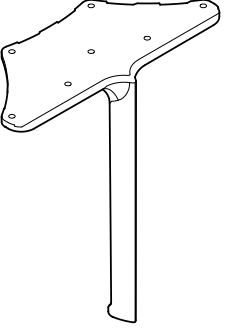
Luna

SPECIFICATION GUIDE: ACCESSORIES AND DETAILS

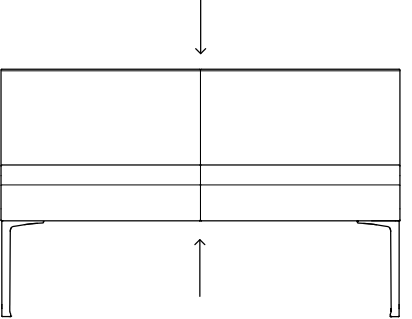
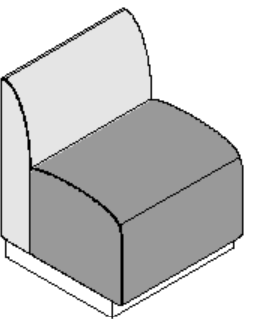
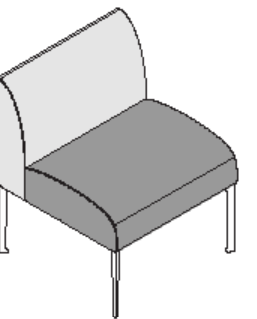
OVERVIEW						
Plinth Position	Start 	Mid 	End 	Freestanding 		
Plinth Ganging	Ganging Bracket 		Side-to-Side 	Back-to-Back 		
Elevated Leg Position	Start 	Mid 	End 	Freestanding 	Start, End Leg Elevated 	Mid Leg Elevated 
Upholstery Details	Standard 	Armless End 	Arm 	Mid Seam (for units 46" and larger) 	Dual Fabric for Plinth Textile 1 - Seat Textile 2 - Back 	Dual Fabric for Elevated Textile 1 - Seat Textile 2 - Back 

PRODUCT INFORMATION

Plinth

The plinth is designed to provide a continuous appearance at the front, back, and exposed ends of a unit. However, the plinth side panels are removed when ordered as the Start, Mid, and End of a ganged layout.

Ganging

Elevated style units employ mid legs for ganging seating units side-to-side and back-to-back, while plinth style units use ganging brackets to connect seats in the same manner. Plinth Start, Mid, and End units can be ganged side-to-side and come with cast aluminum drop-on ganging brackets for tool-free assembly.

Elevated - Legs

Elevated seats share a leg between non-standalone units, while standalone units have four legs. The legs for elevated units are installed in the field.

Glides

All units come standard with adjustable glides, allowing for 3/4" adjustment.

Upholstery Details

- Standard units feature a top-edge seam and are designed to be flush side to side.
- Armless End and Arm units have a roll-style seam at the exposed end of a layout.
- Units 46" and larger include a middle seam.
- Luna offers a dual upholstery option.

Use

Designed for indoor use only.

Performance Standards

Manufactured to comply with:
ANSI/BIFMA X5.4 Lounge Seating Tests (Anticipated Q4 2023)

Certifications

GREENGUARD GOLD (Anticipated Q4 2023)
LEVEL® 1 (Anticipated Q4 2023)

Luna

SPECIFICATION GUIDE: PRODUCT INFORMATION, POWER

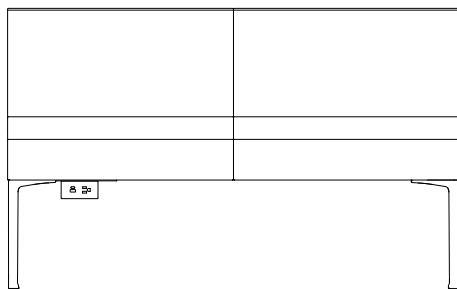
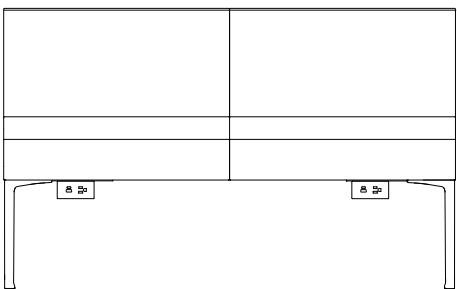
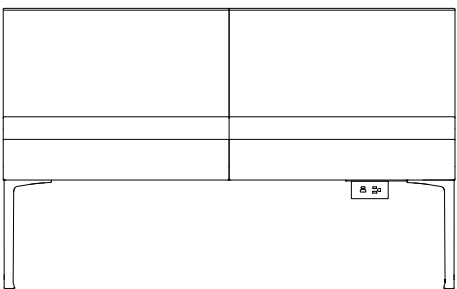
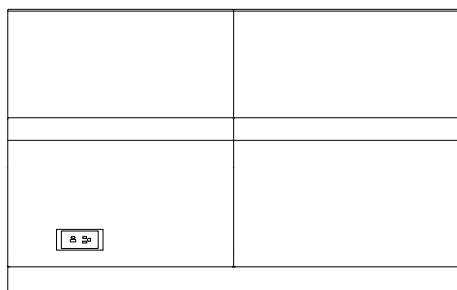
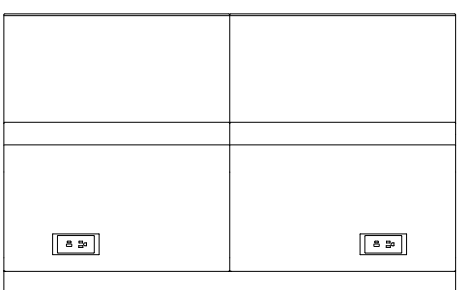
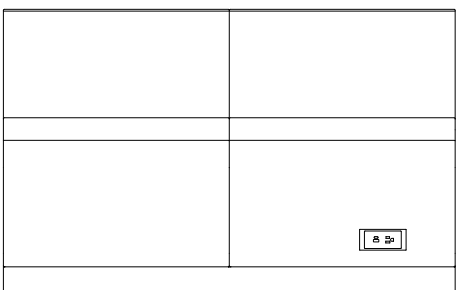
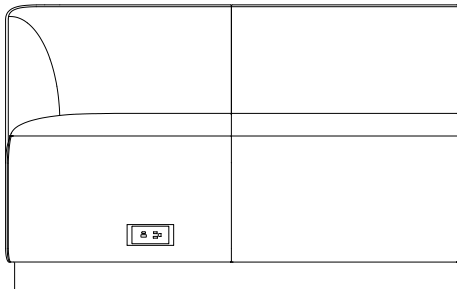
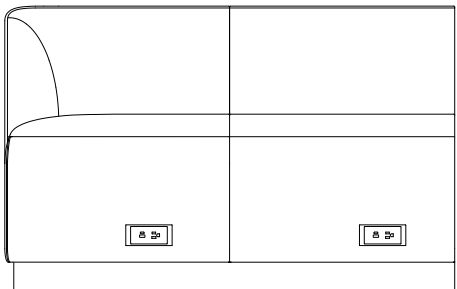
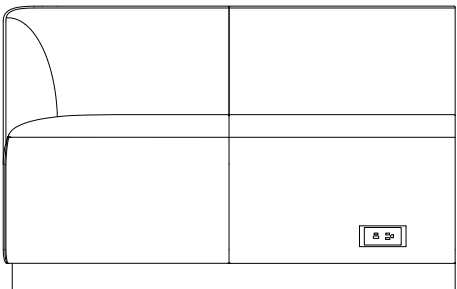
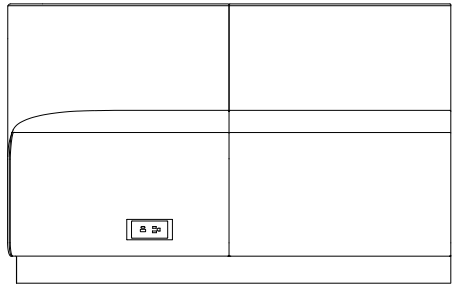
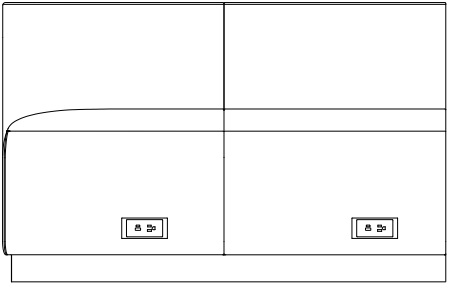
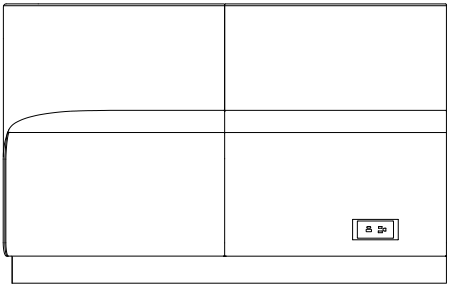
OVERVIEW	POSITION 2 (RIGHT)	POSITION 1 AND 2 (LEFT AND RIGHT)	POSITION 1 (LEFT)
Elevated			
Plinth Standard			
Plinth with Arm(s) (Arm Right Shown)			
Plinth Armless (Armless Right Shown)			

PRODUCT INFORMATION

Power

Elevated units offer undermount power beneath the seats, while plinth units offer flush mount power in the front. You can specify power units to be hardwired or equipped with a 3-prong plug. These units feature one USB-A port, one USB-C port, and a standard grounded 3-prong electrical outlet. Additional power options include daisy chain and wireless surface mount charging. Default cord lengths are 10 feet, with custom lengths available. Power units come with wire management clips for every 1-foot length of cord. Daisy chain infeeds are offered in 5', 10', and 15' standard lengths.

Mounting Options

Under mount power is designated by (U) in the model code. Flush mount power is designated by (F) in the model code.

Cord Length

Both the standard cord and the conduit whip are 10ft long. Other lengths are available as a custom order.

Colors

Under mount power units are offered in black (B), gray (G), and white (W), while flush mount power units are available in black (B) only.

Cable Management

All units include cable mounts and screws for assembly and installation. Power units come with wire management clips for every 1-foot length of cord.

Location

On elevated units, the power is located under the front edge, next to the leg. For plinth units, the power is flush to the front, positioned 8" on center from the side of the unit. However, for arm and armless units, the power is located 16" on center from that side. Units with a tapered front (Arm and Armless) under 45" in length cannot have power on the same side as the arm feature. For units 46" and longer, both left and right power options are available. Units with two arms under 45" in length cannot have power, and power is not available for corner or endcap units.

Example

UB1 - Under mount, black, position 1

FHB12 - Flush mount, hardwired, black, positions 1 & 2

To Order Select Below

1. Mount Type

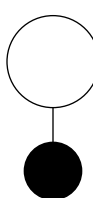

Mount

U	UNDER MOUNT (ELEVATED)	+623
F	FLUSH MOUNT (PLINTH)	+568
UH	UNDER MOUNT HARDWIRE (ELEVATED)	+816
FH	FLUSH MOUNT HARDWIRE (PLINTH)	+784

2. Color

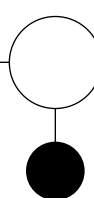

Color

B	BLACK
G	GRAY
W	WHITE

Flush mount only available in black

3. Location

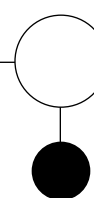

Location

1	POSITION 1 (LEFT)
2	POSITION 2 (RIGHT)

Luna

SPECIFICATION GUIDE: PRODUCT INFORMATION, DAISY CHAIN POWER

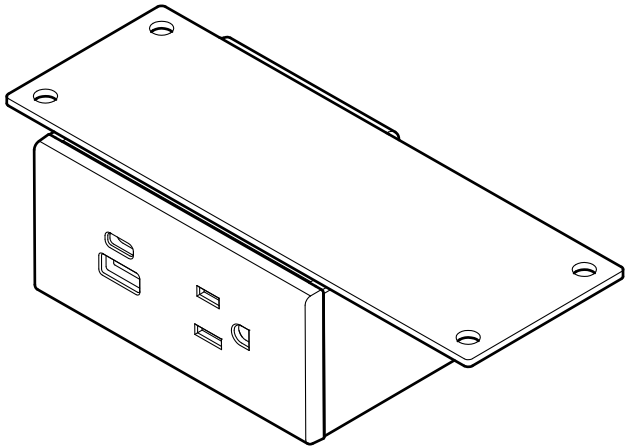
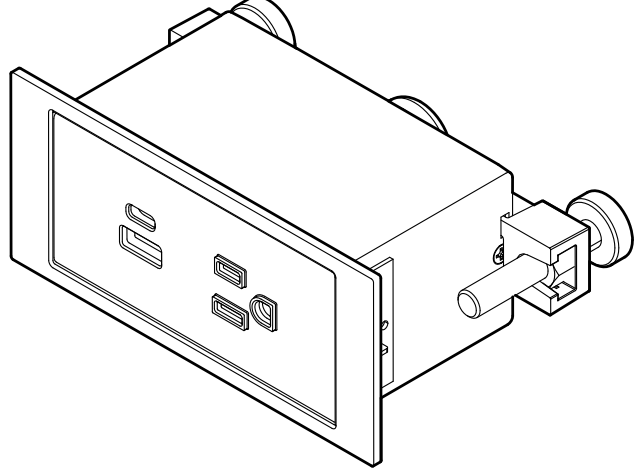
OVERVIEW	UNDER MOUNT (ELEVATED)	SURFACE MOUNT (PLINTH)	
<p>Power Units</p>			

PRODUCT INFORMATION

Power

Elevated units offer undermount power beneath the seats, while plinth units offer flush mount power in the front. You can specify power units to be hardwired or equipped with a 3-prong plug. These units feature one USB-A port, one USB-C port, and a standard grounded 3-prong electrical outlet. Additional power options include daisy chain and wireless surface mount charging. Default cord lengths are 10 feet, with custom lengths available. Power units come with wire management clips for every 1-foot length of cord. Daisy chain infeeds are offered in 5', 10', and 15' standard lengths.

Mounting Options

Under mount power is designated by (U) in the model code. Flush mount power is designated by (F) in the model code.

Cord Length

Both the standard cord and the conduit whip are 10ft long. Other lengths are available as a custom order.

Colors

Under-mount power units are offered in black (B), gray (G), and white (W), while flush-mount power units are available in black (B) only.

Cable Management

All units include cable mounts and screws for assembly and installation. Power units come with wire management clips for every 1-foot length of cord.

Location

On elevated units, the power is located under the front edge, next to the leg. For plinth units, the power is flush to the front, positioned 8" on center from the side of the unit. However, for arm and armless units, the power is located 16" on center from that side. Units with a tapered front (Arm and Armless) under 45" in length cannot have power on the same side as the arm feature. For units 46" and longer, both left and right power options are available. Units with two arms under 45" in length cannot have power, and power is not available for corner or endcap units.

Order Entry

Please get in touch with designapplication@stylexdesign.com. CET is required for order entry to determine jumper lengths and system configuration. All daisy chain units are entered under 1 line.

To Order Select Below

1. Power System

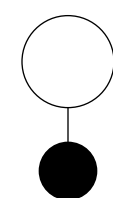

Power System

LNPSBS	LUNA POWER SYSTEM	+155
--------	-------------------	------

2. Options

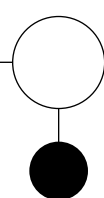

Options

UNDER MOUNT (ELEVATED)	+39
FLUSH MOUNT (PLINTH)	+59
JUMPER EXTENSION	+138

Luna

SPECIFICATION GUIDE: DIMENSIONS, SEATING

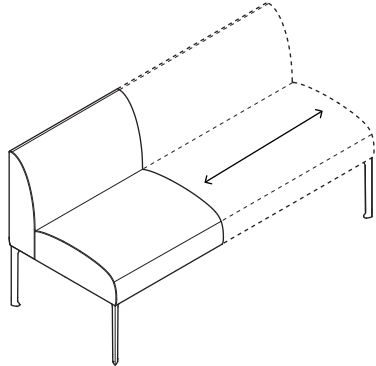
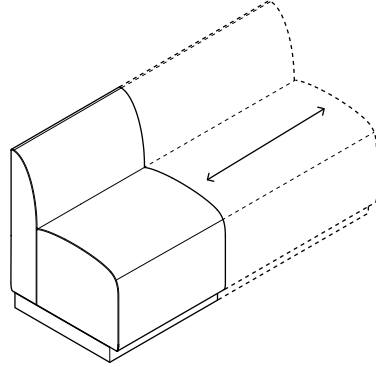
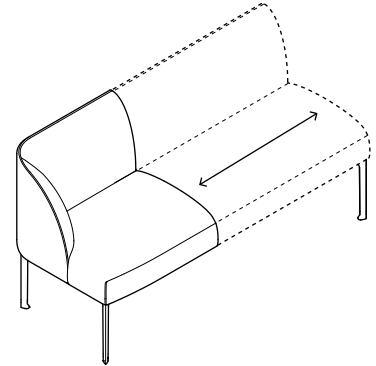
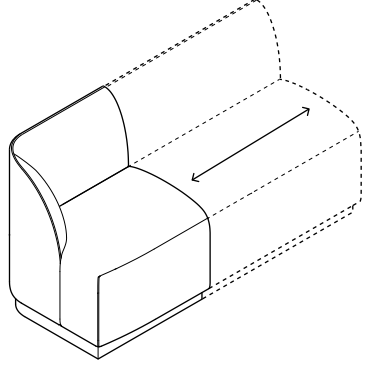
OVERVIEW		ELEVATED & PLINTH SEATING							
<p>Dimensions</p> <p>A. Overall Width B. Overall Depth C1. Overall Height Low Back C2. Overall Height High Back D. Seat Width E. Seat Depth F. Seat Height G. Leg Height H1. Back Height Low Back H2. Back Height High Back</p> <p>Back and seat dimensions are based on compressed, seated dimensions.</p> <p>Elevated seating available without legs for customer's own millwork.</p>	 	<p>Standard</p> <p>A. 25 - 60 B. 25 C1. 31.5 C2. 38.5 D. 25 - 60 E. 19 F. 17.75 G. 12.25 H1. 13.75 H2. 20.75</p>	<p>Arm Left/Right</p> <p>A. 25 - 60 B. 25 C1. 31.5 C2. 38.5 D. 18 - 53 E. 19 F. 17.75 G. 12.25 H1. 13.75 H2. 20.75</p>	<p>Arm Both</p> <p>A. 30 - 60 B. 25 C1. 31.5 C2. 38.5 D. 16 - 46 E. 19 F. 17.75 G. 12.25 H1. 13.75 H2. 20.75</p>	<p>Armless End Left/Right</p> <p>A. 25 - 60 B. 25 C1. 31.5 C2. 38.5 D. 25 - 60 E. 19 F. 17.75 G. 12.25 H1. 13.75 H2. 20.75</p>	<p>Round Inside Corner</p> <p>A. 25 B. 25 C1. 31.5 C2. 38.5 D. 19 E. 19 F. 17.75 G. 12.25 H1. 13.75 H2. 20.75</p>	<p>Square Inside Corner</p> <p>A. 25 B. 25 C1. 31.5 C2. 38.5 D. 19 E. 19 F. 17.75 G. 12.25 H1. 13.75 H2. 20.75</p>	<p>Round Outside Corner</p> <p>A. 25 B. 25 C1. 31.5 C2. 38.5 D. 19 E. 19 F. 17.75 G. 12.25 H1. 13.75 H2. 20.75</p>	<p>Round End Cap</p> <p>A. 50 - 75 B. 25 C1. 31.5 C2. 38.5 D. 50 - 75 E. 19 F. 17.75 G. 12.25 H1. 13.75 H2. 20.75</p>
<p>Arm Choice</p> <p>A. Arm Width B. Arm Depth</p>	 		<p>Arm Left/Right</p> <p>A. 7 B. 9</p>	<p>Arm Both</p> <p>A. 7 B. 9</p>					

Luna

SPECIFICATION GUIDE: DIMENSIONS, PLANTERS, TRAYS, TABLET

OVERVIEW	PLANTERS, FOR LOW BACK		PLANTERS, FOR HIGH BACK					
<p>Dimensions</p> <p>A. Width</p> <p>B. Depth</p> <p>C. Height</p>	<p>Single</p> <p>A. 15</p> <p>B. 15</p> <p>C. 31</p>		<p>Double</p> <p>A. 30</p> <p>B. 15</p> <p>C. 31</p>	<p>Single</p> <p>A. 15</p> <p>B. 15</p> <p>C. 38</p>	<p>Double</p> <p>A. 15</p> <p>B. 15</p> <p>C. 38</p>			
<p>A. Interior Height</p> <p>B. Interior Width (Top)</p> <p>C. Interior Width (Bottom)</p>	<p>Planter Liner</p> <p>A. 11.5</p> <p>B. 12.5</p> <p>C. 11.5</p>							
<p>A. Diameter</p> <p>B. Height Above Seat</p>	<p>Round Tray Table</p> <p>A. 13</p> <p>B. 2.5</p>	<p>Tablet Arm, Under Mount</p> <p>A. 14</p> <p>B. 8.5</p>	<p>Tablet Arm, Seat Mount</p> <p>A. 14</p> <p>B. 8.5</p>					
<p>A. Width</p> <p>B. Depth</p> <p>C. Height Above Seat</p>	<p>Wireless Charging Tray</p> <p>A. 8</p> <p>B. 13</p> <p>C. 3</p>							

Luna

SPECIFICATION GUIDE: HOW TO ORDER, SEATING

MODEL CODE BREAKDOWN

Sample Model Code: LNE21L27DFSBBLUB12COM

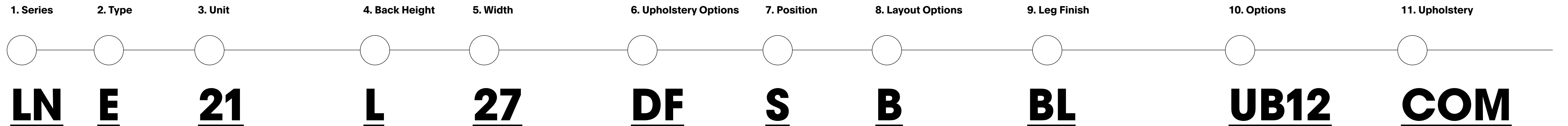

1. Series	2. Type	3. Unit	4. Back Height	5. Width	6. Upholstery Options	7. Position	8. Layout Options	9. Leg Finish	10. Options	11. Upholstery
LN	E	21	L	27	DF	S	B	BL	UB12	COM
Series LN LUNA	Type E ELEVATED P PLINTH	Unit 11 STANDARD 21 ARM LEFT 22 ARM RIGHT 23 ARM BOTH 31 ARMLESS END LEFT 32 ARMLESS END RIGHT 41 ROUND INSIDE CORNER 42 SQUARE INSIDE CORNER 51 ROUND OUTSIDE CORNER 52 ROUND END CAP	Back Height H HIGH BACK L LOW BACK	Width XX CUSTOM WIDTH 25 WIDTH (CORNERS) Units available by the inch between 25 - 60" • 11 - STANDARD • 21 - ARM LEFT • 22 - ARM RIGHT • 31 - ARMLESS LEFT • 32 - ARMLESS RIGHT Units available by the inch between 30 - 60" • 23 - ARM BOTH Units available by the inch between 50 - 75" • 52 - ROUND END CAP Units required to be 25" • 41 - ROUND INSIDE CORNER • 42 - SQUARE INSIDE CORNER • 51 - ROUND OUTSIDE CORNER	Upholstery Options DF DUAL UPHOLSTERY	Position F FREESTANDING S START M MID E END NL NO LEGS	Layout Options B BACK-TO-BACK Back-to-Back not available on mid units	Standard Powder Coated Metal BL BLUE BM BLACK MATTE BR BRASS BT BLACK TWILIGHT CP CHAMPAGNE DB DARK BRONZE DG DARK GRAY DP DUSTY PINK FG FOREST GREEN LG LIGHT GRAY MG MEADOW GREEN MK MILK MS METALLIC SILVER NK NICKEL NV NAVY OR ORANGE PY PALE YELLOW RD RED RO RED ORANGE RR RUSTY RED SB SOFT BLUE SD SAND TC TERRACOTTA TP TAUPE TS TEXTURED SLATE YL YELLOW Other AL POLISHED ALUMINUM	Power Options U___ UNDER MOUNT F___ FLUSH MOUNT _B__ BLACK _G__ GRAY __H_ HARDWIRE ___1 POSITION 1 (LEFT) ___2 POSITION 2 (RIGHT) See power ordering options and rules. Accessory Attachment T TRAY/TABLET ARM ATTACHED TO UNIT Accessory (tray table / tablet arm) attached to right side of seat unit. Not applicable for undermount tablet arms	Textile Grades COM CUSTOMER'S OWN MATERIAL A GRADE A B GRADE B C GRADE C D GRADE D E GRADE E F GRADE F G GRADE G H GRADE H I GRADE I J GRADE J K GRADE K L GRADE L M GRADE M Note: Select highest grade in the case of dual upholstery

Luna

SPECIFICATION GUIDE: HOW TO ORDER, TRAY AND TABLET

MODEL CODE BREAKDOWN

Sample Model Code: LNE72SW81BM

1. Series

2. Type

3. Top Finish

4. Finish

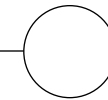
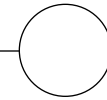
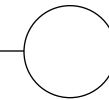
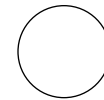

LN **72**

SW81

BM

Series

LN LUNA

Type

- 71 ROUND TRAY TABLE
- 72 WIRELESS CHARGING TRAY
- 75 TABLET ARM, UNDER MOUNT SINGLE SWIVEL
- 76 TABLET ARM, UNDER MOUNT DUAL SWIVEL
- 77 TABLET ARM, SEAT MOUNT SINGLE SWIVEL
- 78 TABLET ARM, SEAT MOUNT DUAL SWIVEL

Wood Finish

- SW81 WHITE OAK
- SW83 MAPLE
- SW85 WALNUT
- SW87 OPAQUE BLACK

Not applicable for Round Table Tray

Standard Powder Coated Metal

- BL BLUE
- BM BLACK MATTE
- BR BRASS
- BT BLACK TWILIGHT
- CP CHAMPAGNE
- DB DARK BRONZE
- DG DARK GRAY
- DP DUSTY PINK
- FG FOREST GREEN
- LG LIGHT GRAY
- MG MEADOW GREEN
- MK MILK
- MS METALLIC SILVER
- NK NICKEL
- NV NAVY
- OR ORANGE
- PY PALE YELLOW
- RD RED
- RO RED ORANGE
- RR RUSTY RED
- SB SOFT BLUE
- SD SAND
- TC TERRACOTTA
- TP TAUPE
- TS TEXTURED SLATE
- YL YELLOW

Not applicable for Wireless Charging Tray

Luna

SPECIFICATION GUIDE: HOW TO ORDER, PLANTER

MODEL CODE BREAKDOWN

Sample Model Code: LN6P3LBLM09

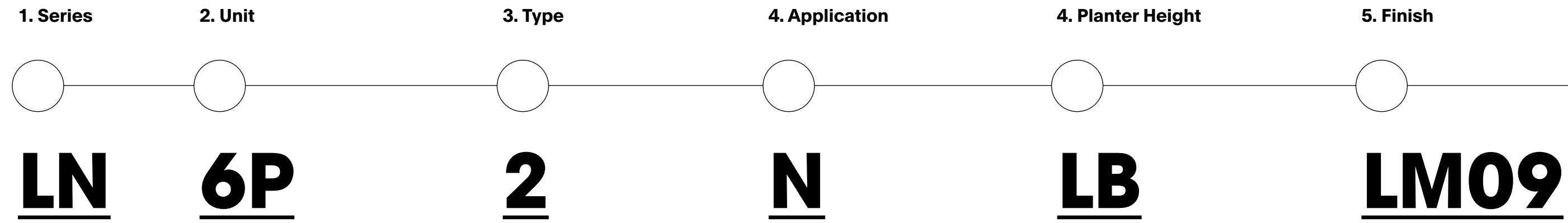

Series
LN LUNA

Unit
6P PLANTER

Type
1 SINGLE
2 DOUBLE

Application
A ENCLOSED
B EXPOSED*

Enclosed planters (A) are not designed to be exposed, they must be surrounded by seating units or placed against a wall

*Exposed planters (B) will be available Q2 2024

Back Height
LB LOW BACK
HB HIGH BACK

Finish
LM09 BLACK

Black Laminate, LM09 is the only available planter finish

Luna

COLORS, MATERIALS, AND FINISHES

POWDER COATED PAINTED METAL

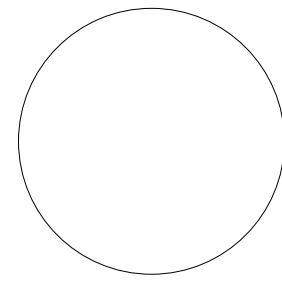

MILK
(MK)

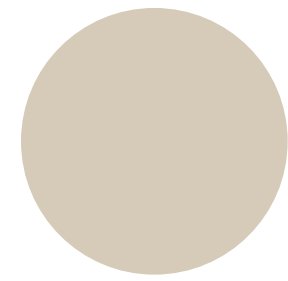

SAND
(SD)

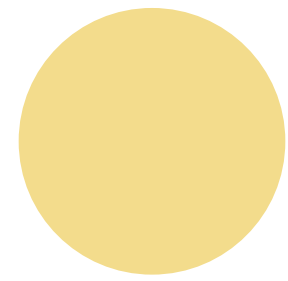

PALE YELLOW
(PY)

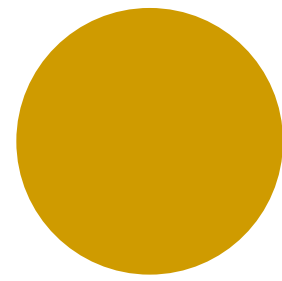

YELLOW
(YL)

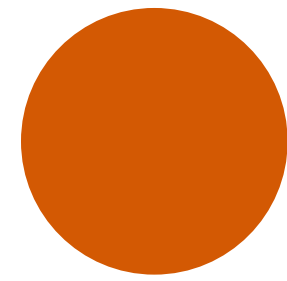

ORANGE
(OR)

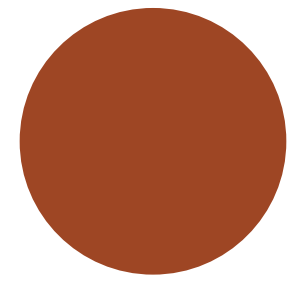

TERRACOTTA
(TC)

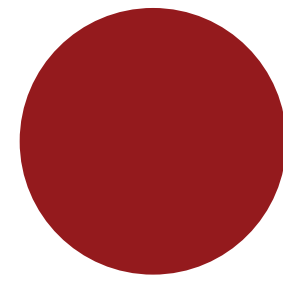

RED
(RD)

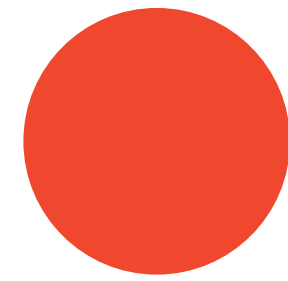

RED ORANGE
(RO)

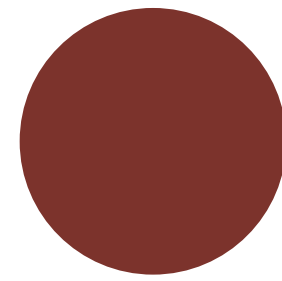

RUSTY RED
(RR)

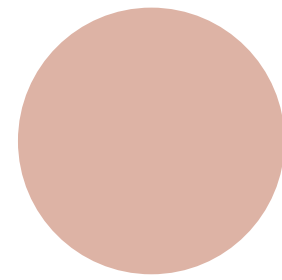

DUSTY PINK
(DP)

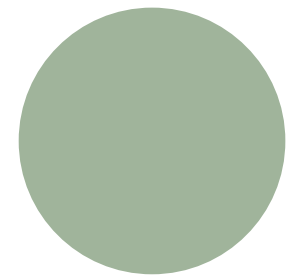

MEADOW GREEN
(MG)

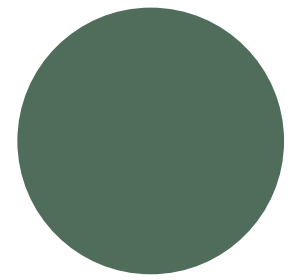

FOREST GREEN
(FG)

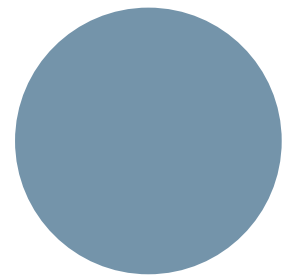

SOFT BLUE
(SB)

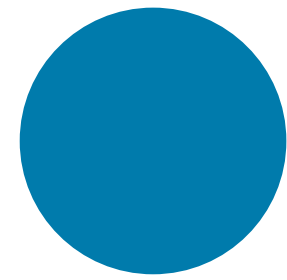

BLUE
(BL)

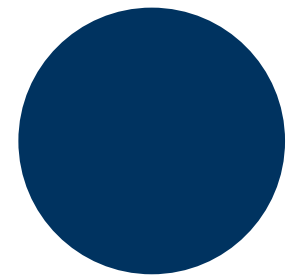

NAVY
(NV)

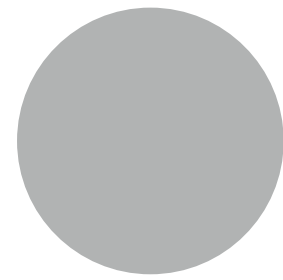

LIGHT GRAY
(LG)



CHAMPAGNE
(CP)

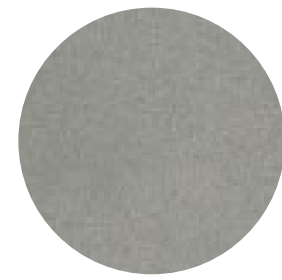

METALLIC SILVER
(MS)

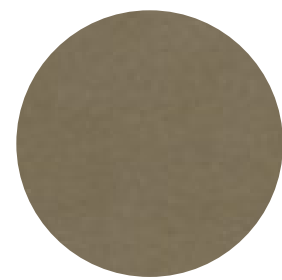

NICKEL
(NK)

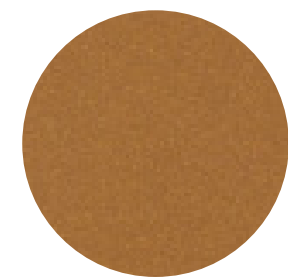

BRASS
(BR)

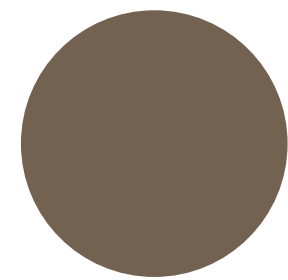

TAUPE
(TP)

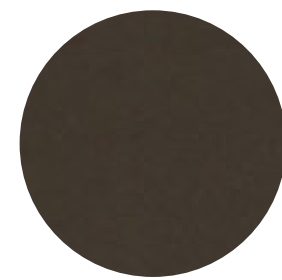

DARK BRONZE
(DB)

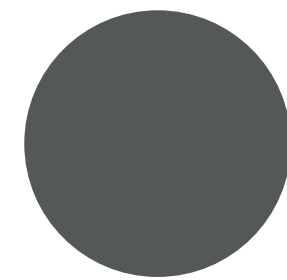

DARK GRAY
(DG)

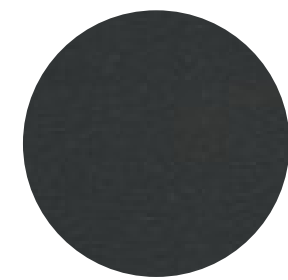

TEXTURED SLATE
(TS)

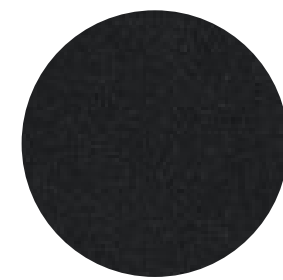

BLACK TWILIGHT
(BT)

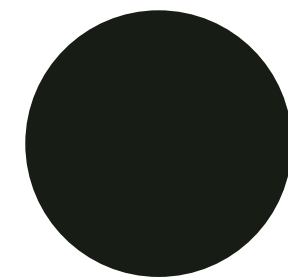

BLACK MATTE
(BM)

SOLID WOOD



MAPLE
(83)



WHITE OAK
(81)



WALNUT
(85)

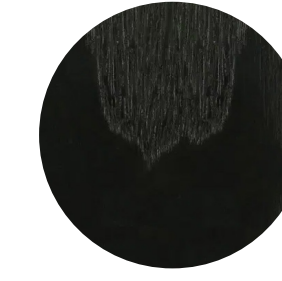

OPAQUE BLACK
(87)

LAMINATE

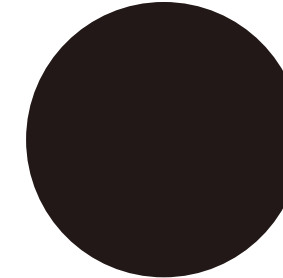

BLACK
(LM09)

Luna

ELEVATED: STANDARD

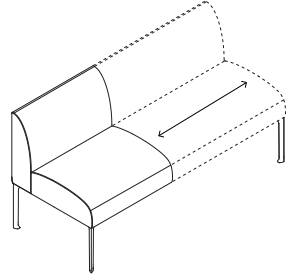
	WIDTHS	SERIES	TYPE	UNIT	BACK HEIGHT	DIMENSIONS	Yardage Requirements			Textile Upholstery Grades														
							SEAT	BACK	BACK/SEAT	COM	A	B	C	D	E	F	G	H	I	J	K	L	M	
 <p>Elevated, Standard, Low Back</p>	25-30in Wide	LN	E	11	L	25-30W x 25D x 31H	1	1.3	2.2	2,002	2,155	2,241	2,326	2,412	2,498	2,592	2,684	2,795	2,928	3,083	3,247	3,406	3,559	
	31-35in Wide	LN	E	11	L	31-35W x 25D x 31H	1.3	1.4	2.6	2,205	2,381	2,480	2,578	2,676	2,776	2,884	2,989	3,117	3,269	3,448	3,637	3,819	3,996	
	36-40in Wide	LN	E	11	L	36-40W x 25D x 31H	1.4	1.6	2.8	2,408	2,600	2,707	2,813	2,920	3,028	3,146	3,260	3,399	3,565	3,759	3,964	4,162	4,354	
	41-45in Wide	LN	E	11	L	41-45W x 25D x 31H	1.5	1.7	3.1	2,611	2,825	2,946	3,064	3,185	3,305	3,437	3,565	3,721	3,907	4,124	4,354	4,576	4,791	
	46-50in Wide	LN	E	11	L	46-50W x 25D x 31H	1.7	1.9	3.5	2,814	3,051	3,185	3,316	3,449	3,583	3,729	3,871	4,043	4,248	4,490	4,744	4,989	5,227	
	51-55in Wide	LN	E	11	L	51-55W x 25D x 31H	1.8	2	3.8	3,017	3,277	3,424	3,568	3,714	3,860	4,020	4,176	4,365	4,590	4,855	5,133	5,403	5,664	
	56-60in Wide	LN	E	11	L	56-60W x 25D x 31H	2	2.2	4.1	3,220	3,503	3,663	3,819	3,978	4,138	4,312	4,481	4,687	4,932	5,220	5,523	5,816	6,100	
 <p>Elevated, Standard, High Back</p>	25-30in Wide	LN	E	11	H	25-30W x 25D x 38H	1	2.1	3	2,118	2,325	2,441	2,555	2,671	2,788	2,915	3,038	3,188	3,367	3,577	3,799	4,013	4,220	
	31-35in Wide	LN	E	11	H	31-35W x 25D x 38H	1.3	2.4	3.5	2,327	2,564	2,698	2,829	2,962	3,096	3,242	3,384	3,556	3,761	4,003	4,257	4,502	4,740	
	36-40in Wide	LN	E	11	H	36-40W x 25D x 38H	1.4	2.7	4	2,535	2,811	2,966	3,118	3,273	3,428	3,597	3,762	3,962	4,201	4,481	4,776	5,061	5,337	
	41-45in Wide	LN	E	11	H	41-45W x 25D x 38H	1.5	3	4.4	2,743	3,049	3,221	3,391	3,562	3,735	3,923	4,106	4,328	4,594	4,905	5,233	5,550	5,857	
	46-50in Wide	LN	E	11	H	46-50W x 25D x 38H	1.7	2.7	4.3	2,952	3,250	3,418	3,583	3,751	3,919	4,103	4,281	4,498	4,756	5,060	5,380	5,689	5,988	
	51-55in Wide	LN	E	11	H	51-55W x 25D x 38H	1.8	3	4.7	3,160	3,481	3,662	3,840	4,020	4,201	4,399	4,591	4,825	5,103	5,430	5,774	6,107	6,429	
	56-60in Wide	LN	E	11	H	56-60W x 25D x 38H	2	3.2	5.1	3,368	3,720	3,918	4,113	4,310	4,509	4,725	4,936	5,191	5,496	5,854	6,231	6,596	6,949	

To Order Select Below

<p>1. Series/Type/Unit</p> <p>LNE11</p> <p>Luna Elevated Standard</p>	<p>2. Back Height</p> <p>H HIGH BACK</p> <p>L LOW BACK</p>	<p>3. Width</p> <p>XX WIDTH</p> <p>Available in 25-60"</p>	<p>4. Upholstery Options</p> <p>DF DUAL UPHOLSTERY</p>	<p>5. Postion</p> <p>F FREESTANDING</p> <p>S START</p> <p>M MID</p> <p>E END</p> <p>NL NO LEGS</p>	<p>6. Layout Options</p> <p>B BACK-TO-BACK</p> <p>Back-to-Back not available on mid units</p>	<p>7. Leg Finish</p> <p>Standard Powder Coated Metal</p> <p>BL BLUE</p> <p>BM BLACK MATTE</p> <p>BR BRASS</p> <p>BT BLACK TWILIGHT</p> <p>CP CHAMPAGNE</p> <p>DB DARK BRONZE</p> <p>DG DARK GRAY</p> <p>DP DUSTY PINK</p> <p>FG FOREST GREEN</p> <p>LG LIGHT GRAY</p> <p>MG MEADOW GREEN</p> <p>MK MILK</p> <p>MS METALLIC SILVER</p> <p>Polished Metal</p> <p>AL POLISHED ALUMINUM</p>	<p>8. Options</p> <p>Power Options</p> <p>See under mount power ordering options and rules.</p> <p>Accessory Attachment</p> <p>T TRAY/TABLET ARM ATTACHED TO UNIT</p> <p>Accessory attaches to right side of seat unit. Trays and tablet arm seat mount units can only be used between units.</p>	<p>9. Upholstery</p> <p>See general information section for details on textile program and COM information.</p>
---	---	---	---	---	--	--	---	---

Luna

ELEVATED: ARM LEFT OR RIGHT

	WIDTHS	SERIES	TYPE	UNIT	BACK HEIGHT	DIMENSIONS	Yardage Requirements			Textile Upholstery Grades														
							SEAT	BACK	BACK/SEAT	COM	A	B	C	D	E	F	G	H	I	J	K	L	M	
 <p>Elevated, Arm Left/Right, Low Back</p>	25-30in Wide	LN	E	21/22	L	25-30W x 25D x 31H	1.3	1.4	2.6	2,474	2,650	2,749	2,847	2,945	3,045	3,153	3,258	3,386	3,538	3,717	3,906	4,088	4,265	
	31-35in Wide	LN	E	21/22	L	31-35W x 25D x 31H	1.5	1.6	2.9	2,679	2,878	2,990	3,100	3,212	3,324	3,446	3,565	3,710	3,882	4,084	4,298	4,504	4,703	
	36-40in Wide	LN	E	21/22	L	36-40W x 25D x 31H	1.6	1.7	3.2	2,884	3,106	3,231	3,354	3,478	3,603	3,740	3,872	4,034	4,226	4,451	4,689	4,919	5,142	
	41-45in Wide	LN	E	21/22	L	41-45W x 25D x 31H	1.7	1.9	3.5	3,089	3,326	3,460	3,591	3,724	3,858	4,004	4,146	4,318	4,523	4,765	5,019	5,264	5,502	
	46-50in Wide	LN	E	21/22	L	46-50W x 25D x 31H	1.6	1.9	3.3	3,294	3,524	3,653	3,780	3,909	4,038	4,179	4,317	4,483	4,682	4,915	5,161	5,399	5,629	
	51-55in Wide	LN	E	21/22	L	51-55W x 25D x 31H	1.7	2	3.6	3,499	3,744	3,882	4,017	4,155	4,293	4,443	4,590	4,767	4,980	5,229	5,491	5,745	5,990	
	56-60in Wide	LN	E	21/22	L	56-60W x 25D x 31H	1.8	2.1	3.9	3,703	3,971	4,122	4,270	4,420	4,571	4,736	4,896	5,090	5,322	5,595	5,882	6,159	6,427	
 <p>Elevated, Arm Left/Right, High Back</p>	25-30in Wide	LN	E	21/22	H	25-30W x 25D x 38H	1.3	1.8	3	2,675	2,882	2,998	3,112	3,228	3,345	3,472	3,595	3,745	3,924	4,134	4,356	4,570	4,777	
	31-35in Wide	LN	E	21/22	H	31-35W x 25D x 38H	1.5	2.1	3.5	2,886	3,123	3,257	3,388	3,521	3,655	3,801	3,943	4,115	4,320	4,562	4,816	5,061	5,299	
	36-40in Wide	LN	E	21/22	H	36-40W x 25D x 38H	1.6	2.4	3.9	3,096	3,364	3,515	3,663	3,813	3,964	4,129	4,289	4,483	4,715	4,988	5,275	5,552	5,820	
	41-45in Wide	LN	E	21/22	H	41-45W x 25D x 38H	1.7	2.7	4.3	3,306	3,604	3,772	3,937	4,105	4,273	4,457	4,635	4,852	5,110	5,414	5,734	6,043	6,342	
	46-50in Wide	LN	E	21/22	H	46-50W x 25D x 38H	1.6	2.2	3.7	3,516	3,769	3,911	4,050	4,192	4,334	4,490	4,641	4,824	5,043	5,300	5,570	5,832	6,085	
	51-55in Wide	LN	E	21/22	H	51-55W x 25D x 38H	1.7	2.4	4	3,726	4,002	4,157	4,309	4,464	4,619	4,788	4,953	5,153	5,392	5,672	5,967	6,252	6,528	
	56-60in Wide	LN	E	21/22	H	56-60W x 25D x 38H	1.8	2.6	4.3	3,936	4,234	4,402	4,567	4,735	4,903	5,087	5,265	5,482	5,740	6,044	6,364	6,673	6,972	

To Order Select Below

<p>1. Series/Type/Unit</p> <p>LUNA ELEVATED ARM LEFT LNE21</p> <p>LUNA ELEVATED ARM RIGHT LNE22</p> <p>Elevated Arm Right shown above</p>	<p>2. Back Height</p> <p>H HIGH BACK</p> <p>L LOW BACK</p>	<p>3. Length</p> <p>XX LENGTH</p> <p>Available in 25-60"</p>	<p>4. Upholstery Options</p> <p>DF DUAL UPHOLSTERY</p>	<p>5. Position</p> <p>F FREESTANDING</p> <p>S START</p> <p>E END</p> <p>NL NO LEGS</p>	<p>6. Layout Options</p> <p>B BACK-TO-BACK</p> <p>Back-to-Back not available on mid units</p>	<p>7. Leg Finish</p> <p>Standard Powder Coated Metal</p> <p>BL BLUE</p> <p>BM BLACK MATTE</p> <p>BR BRASS</p> <p>BT BLACK TWILIGHT</p> <p>CP CHAMPAGNE</p> <p>DB DARK BRONZE</p> <p>DG DARK GRAY</p> <p>DP DUSTY PINK</p> <p>FG FOREST GREEN</p> <p>LG LIGHT GRAY</p> <p>MG MEADOW GREEN</p> <p>MK MILK</p> <p>MS METALLIC SILVER</p> <p>Polished Metal</p> <p>AL POLISHED ALUMINUM</p>	<p>8. Options</p> <p>Power Options</p> <p>See under mount power ordering options and rules.</p> <p>Accessory Attachment</p> <p>T TRAY/TABLET ARM ATTACHED TO UNIT</p> <p>Accessory attaches to right side of seat unit. Trays and tablet arm seat mount units can only be used between units. Not available on Arm Right Units.</p>	<p>9. Upholstery</p> <p>See general information section for details on textile program and COM information.</p>
--	---	---	---	---	--	--	--	--

Luna

ELEVATED: ARM BOTH

	WIDTHS	SERIES	TYPE	UNIT	BACK HEIGHT	DIMENSIONS	Yardage Requirements			Textile Upholstery Grades														
							SEAT	BACK	BACK/SEAT	COM	A	B	C	D	E	F	G	H	I	J	K	L	M	
 <p>Elevated, Arm Both, Low Back</p>	30-35in Wide	LN	E	23	L	30-35W x 25D x 31H	1.7	1.9	3.5	3,103	3,340	3,474	3,605	3,738	3,872	4,018	4,160	4,332	4,537	4,779	5,033	5,278	5,516	
	36-40in Wide	LN	E	23	L	36-40W x 25D x 31H	1.8	2	3.8	3,311	3,571	3,718	3,862	4,008	4,154	4,314	4,470	4,659	4,884	5,149	5,427	5,697	5,958	
	41-45in Wide	LN	E	23	L	41-45W x 25D x 31H	2	2.2	4.1	3,519	3,802	3,962	4,118	4,277	4,437	4,611	4,780	4,986	5,231	5,519	5,822	6,115	6,399	
	46-50in Wide	LN	E	23	L	46-50W x 25D x 31H	1.6	2.1	3.6	3,727	3,972	4,110	4,245	4,383	4,521	4,671	4,818	4,995	5,208	5,457	5,719	5,973	6,218	
	51-55in Wide	LN	E	23	L	51-55W x 25D x 31H	1.7	2.2	3.9	3,935	4,203	4,354	4,502	4,652	4,803	4,968	5,128	5,322	5,554	5,827	6,114	6,391	6,659	
	56-60in Wide	LN	E	23	L	56-60W x 25D x 31H	1.8	2.4	4.1	4,143	4,426	4,586	4,742	4,901	5,061	5,235	5,404	5,610	5,855	6,143	6,446	6,739	7,023	
 <p>Elevated, Arm Both, High Back</p>	30-35in Wide	LN	E	23	H	30-35W x 25D x 38H	1.7	2	3.7	3,390	3,643	3,785	3,924	4,066	4,208	4,364	4,515	4,698	4,917	5,174	5,444	5,706	5,959	
	36-40in Wide	LN	E	23	H	36-40W x 25D x 38H	1.8	2.2	4	3,603	3,879	4,034	4,186	4,341	4,496	4,665	4,830	5,030	5,269	5,549	5,844	6,129	6,405	
	41-45in Wide	LN	E	23	H	41-45W x 25D x 38H	2	2.4	4.3	3,817	4,115	4,283	4,448	4,616	4,784	4,968	5,146	5,363	5,621	5,925	6,245	6,554	6,853	
	46-50in Wide	LN	E	23	H	46-50W x 25D x 38H	1.6	2.6	4	4,030	4,306	4,461	4,613	4,768	4,923	5,092	5,257	5,457	5,696	5,976	6,271	6,556	6,832	
	51-55in Wide	LN	E	23	H	51-55W x 25D x 38H	1.7	2.8	4.3	4,244	4,542	4,710	4,875	5,043	5,211	5,395	5,573	5,790	6,048	6,352	6,672	6,981	7,280	
	56-60in Wide	LN	E	23	H	56-60W x 25D x 38H	1.8	2.9	4.7	4,457	4,778	4,959	5,137	5,317	5,498	5,696	5,888	6,122	6,400	6,727	7,071	7,404	7,726	

To Order Select Below

<p>1. Series/Type/Unit</p> <p>LNE23</p> <p>Luna Elevated Arm Both</p>	<p>2. Back Height</p> <p>H HIGH BACK L LOW BACK</p>	<p>3. Length</p> <p>XX LENGTH</p> <p>Available in 30-60"</p>	<p>4. Upholstery Options</p> <p>DF DUAL UPHOLSTERY</p>	<p>5. Postion</p> <p>F FREESTANDING NL NO LEGS</p>	<p>6. Layout Options</p> <p>B BACK-TO-BACK</p> <p>Back-to-Back not available on mid units</p>	<p>7. Leg Finish</p> <p>Standard Powder Coated Metal</p> <p>BL BLUE BM BLACK MATTE BR BRASS BT BLACK TWILIGHT CP CHAMPAGNE DB DARK BRONZE DG DARK GRAY DP DUSTY PINK FG FOREST GREEN LG LIGHT GRAY MG MEADOW GREEN MK MILK MS METALLIC SILVER</p> <p>Polished Metal</p> <p>AL POLISHED ALUMINUM</p>	<p>8. Options</p> <p>Power Options</p> <p>See under mount power ordering options and rules.</p>	<p>9. Upholstery</p> <p>See general information section for details on textile program and COM information</p>
---	--	---	---	---	--	--	--	--

Luna

ELEVATED: ARMLESS LEFT OR RIGHT

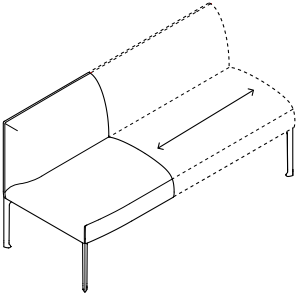
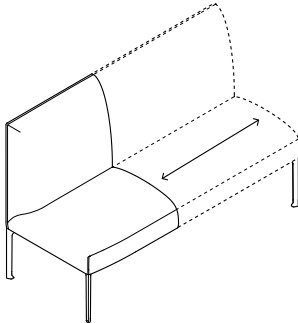
	WIDTHS	SERIES	TYPE	UNIT	BACK HEIGHT	DIMENSIONS	Yardage Requirements			Textile Upholstery Grades														
							SEAT	BACK	BACK/SEAT	COM	A	B	C	D	E	F	G	H	I	J	K	L	M	
	Elevated, Armless End Left/Right, Low Back	25-30in Wide	LN	E	31/32	L	25-30W x 25D x 31H	1.3	1.3	2.5	2,119	2,288	2,382	2,475	2,570	2,665	2,768	2,869	2,991	3,137	3,308	3,489	3,663	3,832
	31-35in Wide	LN	E	31/32	L	31-35W x 25D x 31H	1.5	1.4	2.8	2,322	2,514	2,621	2,727	2,834	2,942	3,060	3,174	3,313	3,479	3,673	3,878	4,076	4,268	
	36-40in Wide	LN	E	31/32	L	36-40W x 25D x 31H	1.6	1.6	3.1	2,525	2,739	2,860	2,978	3,099	3,219	3,351	3,479	3,635	3,821	4,038	4,268	4,490	4,705	
	41-45in Wide	LN	E	31/32	L	41-45W x 25D x 31H	1.7	1.7	3.3	2,728	2,958	3,087	3,214	3,343	3,472	3,613	3,751	3,917	4,116	4,349	4,595	4,833	5,063	
	46-50in Wide	LN	E	31/32	L	46-50W x 25D x 31H	1.7	1.9	3.5	2,931	3,168	3,302	3,433	3,566	3,700	3,846	3,988	4,160	4,365	4,607	4,861	5,106	5,344	
	51-55in Wide	LN	E	31/32	L	51-55W x 25D x 31H	1.8	2	3.8	3,134	3,394	3,541	3,685	3,831	3,977	4,137	4,293	4,482	4,707	4,972	5,250	5,520	5,781	
	56-60in Wide	LN	E	31/32	L	56-60W x 25D x 31H	2	2.1	4.1	3,337	3,620	3,780	3,936	4,095	4,255	4,429	4,598	4,804	5,049	5,337	5,640	5,933	6,217	
	Elevated, Armless End Left/Right, High	25-30in Wide	LN	E	31/32	H	25-30W x 25D x 38H	1.3	2.1	3.3	2,240	2,470	2,599	2,726	2,855	2,984	3,125	3,263	3,429	3,628	3,861	4,107	4,345	4,575
	31-35in Wide	LN	E	31/32	H	31-35W x 25D x 38H	1.5	2.5	3.8	2,449	2,709	2,856	3,000	3,146	3,292	3,452	3,608	3,797	4,022	4,287	4,565	4,835	5,096	
	36-40in Wide	LN	E	31/32	H	36-40W x 25D x 38H	1.6	2.8	4.3	2,657	2,955	3,123	3,288	3,456	3,624	3,808	3,986	4,203	4,461	4,765	5,085	5,394	5,693	
	41-45in Wide	LN	E	31/32	H	41-45W x 25D x 38H	1.7	3.1	4.8	2,865	3,194	3,379	3,561	3,746	3,931	4,134	4,330	4,569	4,854	5,189	5,541	5,882	6,212	
	46-50in Wide	LN	E	31/32	H	46-50W x 25D x 38H	1.7	2.7	4.2	3,074	3,365	3,528	3,689	3,852	4,016	4,195	4,369	4,580	4,832	5,128	5,439	5,741	6,032	
	51-55in Wide	LN	E	31/32	H	51-55W x 25D x 38H	1.8	2.9	4.7	3,282	3,603	3,784	3,962	4,142	4,323	4,521	4,713	4,947	5,225	5,552	5,896	6,229	6,551	
	56-60in Wide	LN	E	31/32	H	56-60W x 25D x 38H	2	3.1	5	3,490	3,834	4,028	4,219	4,412	4,606	4,818	5,024	5,274	5,572	5,922	6,291	6,648	6,993	

To Order Select Below

<p>1. Series/Type/Unit</p> <p>LUNA ELEVATED ARMLESS LEFT LNE31</p> <p>LUNA ELEVATED ARMLESS RIGHT LNE32</p> <p>Elevated Armless Right shown above</p>	<p>2. Back Height</p> <p>H HIGH BACK</p> <p>L LOW BACK</p>	<p>3. Width</p> <p>XX WIDTH</p> <p>Available in 25-60"</p>	<p>4. Upholstery Options</p> <p>DF DUAL UPHOLSTERY</p>	<p>5. Position</p> <p>F FREESTANDING</p> <p>S START</p> <p>E END</p> <p>NL NO LEGS</p>	<p>6. Layout Options</p> <p>B BACK-TO-BACK</p> <p>Back-to-Back not available on mid units</p>	<p>7. Leg Finish</p> <p>Standard Powder Coated Metal</p> <p>BL BLUE</p> <p>BM BLACK MATTE</p> <p>BR BRASS</p> <p>BT BLACK TWILIGHT</p> <p>CP CHAMPAGNE</p> <p>DB DARK BRONZE</p> <p>DG DARK GRAY</p> <p>DP DUSTY PINK</p> <p>FG FOREST GREEN</p> <p>LG LIGHT GRAY</p> <p>MG MEADOW GREEN</p> <p>MK MILK</p> <p>MS METALLIC SILVER</p> <p>Polished Metal</p> <p>AL POLISHED ALUMINUM</p>	<p>8. Options</p> <p>Power Options</p> <p>See under mount power ordering options and rules.</p> <p>Accessory Attachment</p> <p>T TRAY/TABLET ARM ATTACHED TO UNIT</p> <p>Accessory attaches to right side of seat unit. Trays and tablet arm seat mount units can only be used between units. Not available on Armless Right Units.</p>	<p>9. Upholstery</p> <p>See general information section for details on textile program and COM information.</p>
--	---	---	---	---	--	--	--	--

Luna

ELEVATED: ROUND INSIDE CORNER

	WIDTH	SERIES	TYPE	UNIT	BACK HEIGHT	DIMENSIONS	Yardage Requirements			Textile Upholstery Grades													
							SEAT	BACK	BACK/SEAT	COM	A	B	C	D	E	F	G	H	I	J	K	L	M
 <p>Elevated, Round Inside Corner, Low Back</p>	25	LN	E	41	L	25W x 25D x 31H	0.8	1.7	2.4	2,238	2,399	2,489	2,578	2,668	2,759	2,858	2,954	3,071	3,210	3,373	3,545	3,712	3,873
 <p>Elevated, Round Inside Corner, High Back</p>	25	LN	E	41	H	25W x 25D x 38H	0.8	2.6	3.2	2,453	2,675	2,800	2,923	3,047	3,172	3,309	3,441	3,603	3,795	4,020	4,258	4,488	4,711

To Order Select Below

1. Series/Type/Unit

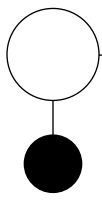

- LNE41
- Luna Elevated Round Inside Corner**

2. Back Height

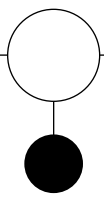

- Back Height**
- H HIGH BACK
- L LOW BACK

3. Width

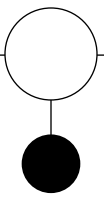

- Width**
- 25 WIDTH

4. Upholstery Options

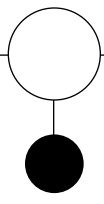

- Upholstery Options**
- DF DUAL UPHOLSTERY

5. Position

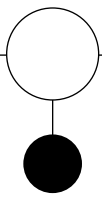

- Position**
- M MID
- NL NO LEGS

6. Leg Finish

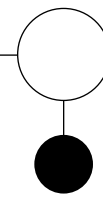

- Standard Powder Coated Metal**
- BL BLUE
- BM BLACK MATTE
- BR BRASS
- BT BLACK TWILIGHT
- CP CHAMPAGNE
- DB DARK BRONZE
- DG DARK GRAY
- DP DUSTY PINK
- FG FOREST GREEN
- LG LIGHT GRAY
- MG MEADOW GREEN
- MK MILK
- MS METALLIC SILVER
- NK NICKEL
- NV NAVY
- OR ORANGE
- PY PALE YELLOW
- RD RED
- RO RED ORANGE
- RR RUSTY RED
- SB SOFT BLUE
- SD SAND
- TC TERRACOTTA
- TP TAUPE
- TS TEXTURED SLATE
- YL YELLOW
- Polished Metal**
- AL POLISHED ALUMINUM

7. Upholstery

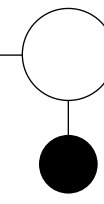

See general information section for details on textile program and COM information

Luna

ELEVATED: SQUARE INSIDE CORNER

	WIDTH	SERIES	TYPE	UNIT	BACK HEIGHT	DIMENSIONS	Yardage Requirements			Textile Upholstery Grades													
							SEAT	BACK	BACK/SEAT	COM	A	B	C	D	E	F	G	H	I	J	K	L	M
 <p>Elevated, Square Inside Corner, Low Back</p>	25	LN	E	42	L	25W x 25D x 31H	0.8	1.7	2.4	2,208	2,369	2,459	2,548	2,638	2,729	2,828	2,924	3,041	3,180	3,343	3,515	3,682	3,843
 <p>Elevated, Square Inside Corner, High Back</p>	25	LN	E	42	H	25W x 25D x 38H	0.8	2.7	3.3	2,364	2,594	2,723	2,850	2,979	3,108	3,249	3,387	3,553	3,752	3,985	4,231	4,469	4,699

To Order Select Below

1. Series/Type/Unit

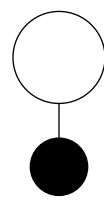

LNE42

Luna
Elevated
Square Inside Corner

2. Back Height

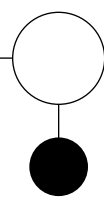

Back Height

H HIGH BACK

L LOW BACK

3. Width

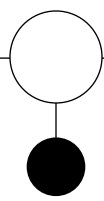

Width

25 WIDTH

4. Upholstery Options

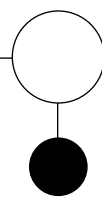

Upholstery Options

DF DUAL UPHOLSTERY

5. Position

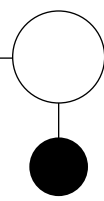

Position

M MID

NL NO LEGS

6. Leg Finish

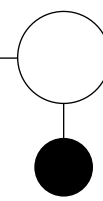

Standard Powder Coated Metal

BL BLUE

BM BLACK MATTE

BR BRASS

BT BLACK TWILIGHT

CP CHAMPAGNE

DB DARK BRONZE

DG DARK GRAY

DP DUSTY PINK

FG FOREST GREEN

LG LIGHT GRAY

MG MEADOW GREEN

MK MILK

MS METALLIC SILVER

NK NICKEL

NV NAVY

OR ORANGE

PY PALE YELLOW

RD RED

RO RED ORANGE

RR RUSTY RED

SB SOFT BLUE

SD SAND

TC TERRACOTTA

TP TAUPE

TS TEXTURED SLATE

YL YELLOW

Polished Metal

AL POLISHED ALUMINUM

7. Upholstery

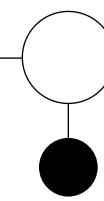

See general information section for details on textile program and COM information

Luna

ELEVATED: ROUND OUTSIDE CORNER

	WIDTH	SERIES	TYPE	UNIT	BACK HEIGHT	DIMENSIONS	Yardage Requirements			Textile Upholstery Grades													
							SEAT	BACK	BACK/SEAT	COM	A	B	C	D	E	F	G	H	I	J	K	L	M
 Elevated, Round Outside Corner, Low Back	25	LN	E	51	L	25W x 25D x 31H	1.4	0.5	1.8	1,452	1,575	1,644	1,711	1,780	1,849	1,924	1,998	2,086	2,193	2,317	2,448	2,575	2,698
 Elevated, Round Outside Corner, High Back	25	LN	E	51	H	25W x 25D x 38H	1.4	0.5	1.8	1,563	1,686	1,755	1,822	1,891	1,960	2,035	2,109	2,197	2,304	2,428	2,559	2,686	2,809

To Order Select Below

1. Series/Type/Unit

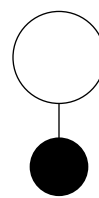

LNE51
Luna Elevated Round Outside Corner

2. Back Height

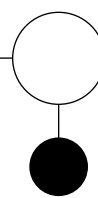

Back Height
H HIGH BACK
L LOW BACK

3. Width

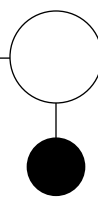

Width
25 WIDTH

4. Upholstery Options

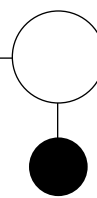

Upholstery Options
DF DUAL UPHOLSTERY

5. Position

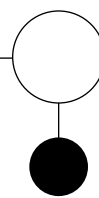

Position
M MID
NL NO LEGS

6. Leg Finish

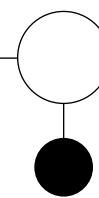

Standard Powder Coated Metal

BL BLUE	NK NICKEL
BM BLACK MATTE	NV NAVY
BR BRASS	OR ORANGE
BT BLACK TWILIGHT	PY PALE YELLOW
CP CHAMPAGNE	RD RED
DB DARK BRONZE	RO RED ORANGE
DG DARK GRAY	RR RUSTY RED
DP DUSTY PINK	SB SOFT BLUE
FG FOREST GREEN	SD SAND
LG LIGHT GRAY	TC TERRACOTTA
MG MEADOW GREEN	TP TAUPE
MK MILK	TS TEXTURED SLATE
MS METALLIC SILVER	YL YELLOW

Polished Metal

AL POLISHED ALUMINUM

7. Options

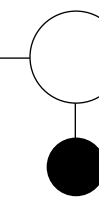

Accessory Attachment
T TRAY/TABLET ARM ATTACHED TO UNIT

Accessory attaches to right side of seat unit. Trays and tablet arm seat mount units can only be used between units

8. Upholstery

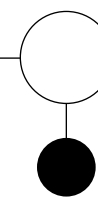

See general information section for details on textile program and COM information

Luna

ELEVATED: ROUND END CAP

	WIDTHS	SERIES	TYPE	UNIT	BACK HEIGHT	DIMENSIONS	Yardage Requirements			Textile Upholstery Grades														
							SEAT	BACK	BACK/SEAT	COM	A	B	C	D	E	F	G	H	I	J	K	L	M	
	Elevated, Round End Cap, Low Back	50-55in Wide	LN	E	52	L	50-55W x 25D x 31H	1.9	0.7	2.6	2,859	3,035	3,134	3,232	3,330	3,430	3,538	3,643	3,771	3,923	4,102	4,291	4,473	4,650
	56-60in Wide	LN	E	52	L	56-60W x 25D x 31H	1.9	0.8	2.7	2,974	3,158	3,261	3,363	3,466	3,569	3,682	3,792	3,925	4,085	4,271	4,468	4,658	4,842	
	61-65in Wide	LN	E	52	L	61-65W x 25D x 31H	2	1	3	3,088	3,295	3,411	3,525	3,641	3,758	3,885	4,008	4,158	4,337	4,547	4,769	4,983	5,190	
	66-70in Wide	LN	E	52	L	66-70W x 25D x 31H	2.1	1.1	3.2	3,203	3,425	3,550	3,673	3,797	3,922	4,059	4,191	4,353	4,545	4,770	5,008	5,238	5,461	
	71-75in Wide	LN	E	52	L	71-75W x 25D x 31H	2.2	1.4	3.6	3,317	3,562	3,700	3,835	3,973	4,111	4,261	4,408	4,585	4,798	5,047	5,309	5,563	5,808	
	Elevated, Round End Cap, High Back	50-55in Wide	LN	E	52	H	50-55W x 25D x 38H	1.9	0.9	2.8	2,941	3,133	3,240	3,346	3,453	3,561	3,679	3,793	3,932	4,098	4,292	4,497	4,695	4,887
	56-60in Wide	LN	E	52	H	56-60W x 25D x 38H	1.9	1	2.9	3,052	3,251	3,363	3,473	3,585	3,697	3,819	3,938	4,083	4,255	4,457	4,671	4,877	5,076	
	61-65in Wide	LN	E	52	H	61-65W x 25D x 38H	2	1.4	3.3	3,164	3,394	3,523	3,650	3,779	3,908	4,049	4,187	4,353	4,552	4,785	5,031	5,269	5,499	
	66-70in Wide	LN	E	52	H	66-70W x 25D x 38H	2.1	1.6	3.7	3,275	3,528	3,670	3,809	3,951	4,093	4,249	4,400	4,583	4,802	5,059	5,329	5,591	5,844	
	71-75in Wide	LN	E	52	H	71-75W x 25D x 38H	2.2	1.9	4.1	3,386	3,669	3,829	3,985	4,144	4,304	4,478	4,647	4,853	5,098	5,386	5,689	5,982	6,266	

To Order Select Below

1. Series/Type/Unit

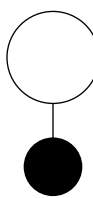

LNE52

**Luna
Elevated
Round End Cap**

2. Back Height

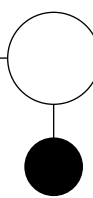

Back Height

H HIGH BACK
L LOW BACK

3. Width

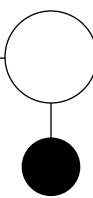

Width

XX WIDTH

Available in 50-75"

65" is for wrapping around planters.

4. Upholstery Options

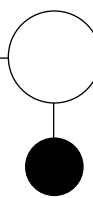

Upholstery Options

DF DUAL UPHOLSTERY

5. Postion

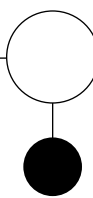

Position

M MID
NL NO LEGS

6. Leg Finish

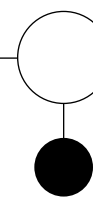

Standard Powder Coated Metal

BL BLUE
BM BLACK MATTE
BR BRASS
BT BLACK TWILIGHT
CP CHAMPAGNE
DB DARK BRONZE
DG DARK GRAY
DP DUSTY PINK
FG FOREST GREEN
LG LIGHT GRAY
MG MEADOW GREEN
MK MILK
MS METALLIC SILVER

NK NICKEL
NV NAVY
OR ORANGE
PY PALE YELLOW
RD RED
RO RED ORANGE
RR RUSTY RED
SB SOFT BLUE
SD SAND
TC TERRACOTTA
TP TAUPE
TS TEXTURED SLATE
YL YELLOW

Polished Metal

AL POLISHED ALUMINUM

7. Options

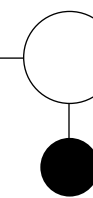

Accessory Attachment

T TRAY/TABLET ARM
ATTACHED TO UNIT

Accessory attaches to right side of seat unit. Trays and tablet arm seat mount units can only be used between units

8. Upholstery

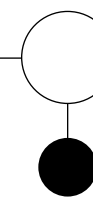

See general information section for details on textile program and COM information

Luna

PLINTH: STANDARD

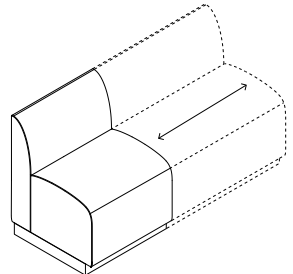
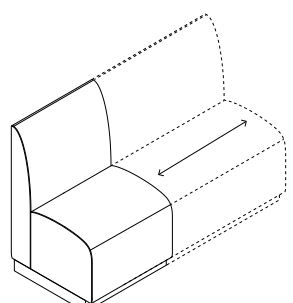
	WIDTHS	SERIES	TYPE	UNIT	BACK HEIGHT	DIMENSIONS	Yardage Requirements			Textile Upholstery Grades														
							SEAT	BACK	BACK/SEAT	COM	A	B	C	D	E	F	G	H	I	J	K	L	M	
 <p>Plinth, Standard, Low Back</p>	25-30in Wide	LN	P	11	L	25-30W x 25D x 31H	1.7	1.5	3	2,516	2,723	2,839	2,953	3,069	3,186	3,313	3,436	3,586	3,765	3,975	4,197	4,411	4,618	
	31-35in Wide	LN	P	11	L	31-35W x 25D x 31H	1.8	1.6	3.3	2,699	2,929	3,058	3,185	3,314	3,443	3,584	3,722	3,888	4,087	4,320	4,566	4,804	5,034	
	36-40in Wide	LN	P	11	L	36-40W x 25D x 31H	1.9	1.8	3.7	2,882	3,135	3,277	3,416	3,558	3,700	3,856	4,007	4,190	4,409	4,666	4,936	5,198	5,451	
	41-45in Wide	LN	P	11	L	41-45W x 25D x 31H	2.1	1.9	4	3,065	3,341	3,496	3,648	3,803	3,958	4,127	4,292	4,492	4,731	5,011	5,306	5,591	5,867	
	46-50in Wide	LN	P	11	L	46-50W x 25D x 31H	2.2	2.1	4.2	3,248	3,539	3,702	3,863	4,026	4,190	4,369	4,543	4,754	5,006	5,302	5,613	5,915	6,206	
	51-55in Wide	LN	P	11	L	51-55W x 25D x 31H	2.5	2.2	4.6	3,431	3,745	3,921	4,095	4,271	4,448	4,641	4,828	5,056	5,328	5,647	5,983	6,308	6,622	
	56-60in Wide	LN	P	11	L	56-60W x 25D x 31H	2.6	2.5	4.9	3,614	3,951	4,140	4,326	4,515	4,705	4,912	5,113	5,358	5,650	5,992	6,353	6,701	7,039	
 <p>Plinth, Standard, High Back</p>	25-30in Wide	LN	P	11	H	25-30W x 25D x 38H	1.7	2.4	3.9	2,660	2,928	3,079	3,227	3,377	3,528	3,693	3,853	4,047	4,279	4,552	4,839	5,116	5,384	
	31-35in Wide	LN	P	11	H	31-35W x 25D x 38H	1.8	2.7	4.3	2,890	3,188	3,356	3,521	3,689	3,857	4,041	4,219	4,436	4,694	4,998	5,318	5,627	5,926	
	36-40in Wide	LN	P	11	H	36-40W x 25D x 38H	1.9	3	4.9	3,120	3,457	3,646	3,832	4,021	4,211	4,418	4,619	4,864	5,156	5,498	5,859	6,207	6,545	
	41-45in Wide	LN	P	11	H	41-45W x 25D x 38H	2.1	3.2	5.3	3,350	3,717	3,924	4,127	4,333	4,540	4,766	4,986	5,252	5,571	5,944	6,338	6,718	7,086	
	46-50in Wide	LN	P	11	H	46-50W x 25D x 38H	2.2	2.9	5.1	3,580	3,932	4,130	4,325	4,522	4,721	4,937	5,148	5,403	5,708	6,066	6,443	6,808	7,161	
	51-55in Wide	LN	P	11	H	51-55W x 25D x 38H	2.5	3.1	5.5	3,810	4,193	4,408	4,619	4,834	5,050	5,285	5,514	5,792	6,123	6,512	6,922	7,318	7,702	
	56-60in Wide	LN	P	11	H	56-60W x 25D x 38H	2.6	3.3	5.9	4,039	4,444	4,673	4,897	5,125	5,353	5,602	5,845	6,140	6,491	6,903	7,338	7,758	8,164	

To Order Select Below

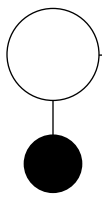
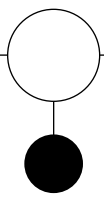
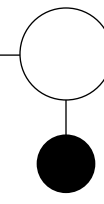
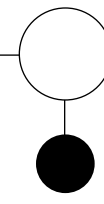
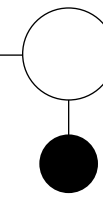
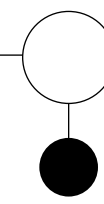
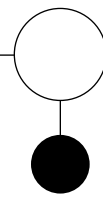
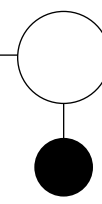
<p>1. Series/Type/Unit</p>  <hr/> <p>LNP11</p> <p>Luna Plinth Standard</p>	<p>2. Back Height</p>  <hr/> <p>H HIGH BACK</p> <p>L LOW BACK</p>	<p>3. Width</p>  <hr/> <p>XX WIDTH</p> <p>Available in 25-60"</p>	<p>4. Upholstery Options</p>  <hr/> <p>DF DUAL UPHOLSTERY</p>	<p>5. Postion</p>  <hr/> <p>F FREESTANDING</p> <p>S START</p> <p>M MID</p> <p>E END</p>	<p>6. Layout Options</p>  <hr/> <p>B BACK-TO-BACK</p> <p>Back-to-Back not available on mid units</p>	<p>7. Options</p>  <hr/> <p>Power Options</p> <p>See flush mount power ordering options and rules.</p> <hr/> <p>Accessory Attachment</p> <p>T TRAY/TABLET ARM ATTACHED TO UNIT</p> <p>Accessory attaches to right side of seat unit. Trays and tablet arm seat mount units can only be used between units.</p>	<p>8. Upholstery</p>  <hr/> <p>See general information section for details on textile program and COM information</p>
--	---	---	--	---	--	--	---

Luna

PLINTH: ARM LEFT OR RIGHT

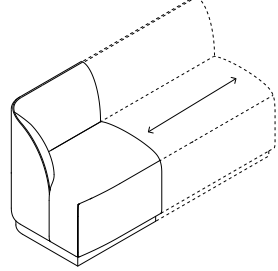
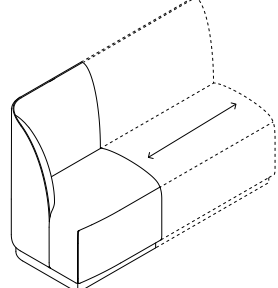
	WIDTHS	SERIES	TYPE	UNIT	BACK HEIGHT	DIMENSIONS	Yardage Requirements			Textile Upholstery Grades														
							SEAT	BACK	BACK/SEAT	COM	A	B	C	D	E	F	G	H	I	J	K	L	M	
 <p>Plinth, Arm Left/Right, Low Back</p>	25-30in Wide	LN	P	21/22	L	25-30W x 25D x 31H	1.5	1.6	3	3,090	3,297	3,413	3,527	3,643	3,760	3,887	4,010	4,160	4,339	4,549	4,771	4,985	5,192	
	31-35in Wide	LN	P	21/22	L	31-35W x 25D x 31H	1.7	1.8	3.3	3,276	3,506	3,635	3,762	3,891	4,020	4,161	4,299	4,465	4,664	4,897	5,143	5,381	5,611	
	36-40in Wide	LN	P	21/22	L	36-40W x 25D x 31H	1.8	1.9	3.7	3,461	3,714	3,856	3,995	4,137	4,279	4,435	4,586	4,769	4,988	5,245	5,515	5,777	6,030	
	41-45in Wide	LN	P	21/22	L	41-45W x 25D x 31H	1.9	2.1	4	3,646	3,922	4,077	4,229	4,384	4,539	4,708	4,873	5,073	5,312	5,592	5,887	6,172	6,448	
	46-50in Wide	LN	P	21/22	L	46-50W x 25D x 31H	2	2.2	4.1	3,831	4,114	4,274	4,430	4,589	4,749	4,923	5,092	5,298	5,543	5,831	6,134	6,427	6,711	
	51-55in Wide	LN	P	21/22	L	51-55W x 25D x 31H	2.1	2.4	4.4	4,016	4,322	4,494	4,664	4,835	5,008	5,196	5,379	5,601	5,867	6,178	6,506	6,823	7,130	
	56-60in Wide	LN	P	21/22	L	56-60W x 25D x 31H	2.2	2.5	4.7	4,201	4,522	4,703	4,881	5,061	5,242	5,440	5,632	5,866	6,144	6,471	6,815	7,148	7,470	
 <p>Plinth, Arm Left/Right, High Back</p>	25-30in Wide	LN	P	21/22	H	25-30W x 25D x 38H	1.5	2.4	3.7	3,324	3,577	3,719	3,858	4,000	4,142	4,298	4,449	4,632	4,851	5,108	5,378	5,640	5,893	
	31-35in Wide	LN	P	21/22	H	31-35W x 25D x 38H	1.7	2.6	4.1	3,555	3,838	3,998	4,154	4,313	4,473	4,647	4,816	5,022	5,267	5,555	5,858	6,151	6,435	
	36-40in Wide	LN	P	21/22	H	36-40W x 25D x 38H	1.8	2.9	4.6	3,786	4,100	4,276	4,450	4,626	4,803	4,996	5,183	5,411	5,683	6,002	6,338	6,663	6,977	
	41-45in Wide	LN	P	21/22	H	41-45W x 25D x 38H	1.9	3.2	5.1	4,017	4,369	4,567	4,762	4,959	5,158	5,374	5,585	5,840	6,145	6,503	6,880	7,245	7,598	
	46-50in Wide	LN	P	21/22	H	46-50W x 25D x 38H	2	3.2	5.2	4,248	4,608	4,810	5,009	5,211	5,413	5,634	5,850	6,111	6,422	6,788	7,173	7,546	7,906	
	51-55in Wide	LN	P	21/22	H	51-55W x 25D x 38H	2.1	3.6	5.5	4,479	4,862	5,077	5,288	5,503	5,719	5,954	6,183	6,461	6,792	7,181	7,591	7,987	8,371	
	56-60in Wide	LN	P	21/22	H	56-60W x 25D x 38H	2.2	3.8	6	4,710	5,123	5,356	5,584	5,816	6,049	6,303	6,550	6,850	7,208	7,628	8,071	8,499	8,913	

To Order Select Below

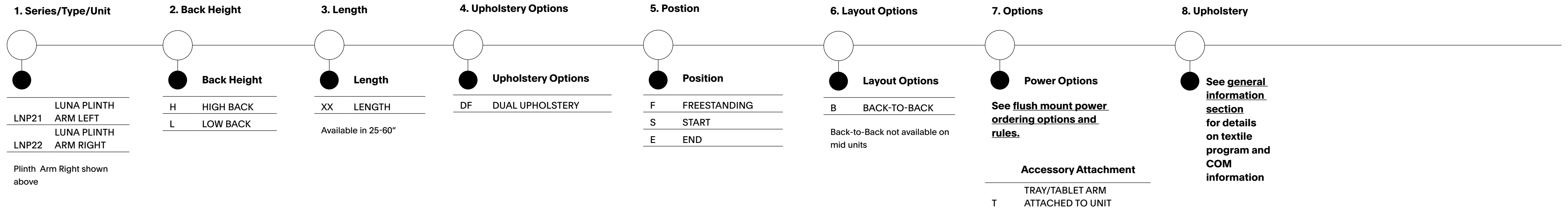

Luna

PLINTH: ARM BOTH

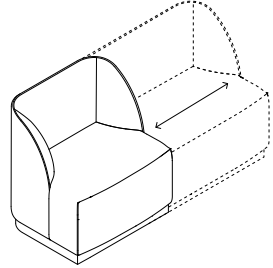
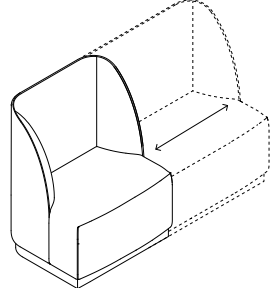
	WIDTHS	SERIES	TYPE	UNIT	BACK HEIGHT	DIMENSIONS	Yardage Requirements			Textile Upholstery Grades														
							SEAT	BACK	BACK/SEAT	COM	A	B	C	D	E	F	G	H	I	J	K	L	M	
 <p>Plinth, Arm Both, Low Back</p>	30-35in Wide	LN	P	23	L	30-35W x 25D x 31H	1.4	2	3.2	3,957	4,179	4,304	4,427	4,551	4,676	4,813	4,945	5,107	5,299	5,524	5,762	5,992	6,215	
	36-40in Wide	LN	P	23	L	36-40W x 25D x 31H	1.5	2.1	3.5	4,147	4,384	4,518	4,649	4,782	4,916	5,062	5,204	5,376	5,581	5,823	6,077	6,322	6,560	
	41-45in Wide	LN	P	23	L	41-45W x 25D x 31H	1.6	2.4	3.8	4,336	4,596	4,743	4,887	5,033	5,179	5,339	5,495	5,684	5,909	6,174	6,452	6,722	6,983	
	46-50in Wide	LN	P	23	L	46-50W x 25D x 31H	1.7	2.5	4.1	4,526	4,809	4,969	5,125	5,284	5,444	5,618	5,787	5,993	6,238	6,526	6,829	7,122	7,406	
	51-55in Wide	LN	P	23	L	51-55W x 25D x 31H	1.8	2.6	4.3	4,716	5,014	5,182	5,347	5,515	5,683	5,867	6,045	6,262	6,520	6,824	7,144	7,453	7,752	
	56-60in Wide	LN	P	23	L	56-60W x 25D x 31H	2	2.8	4.7	4,905	5,226	5,407	5,585	5,765	5,946	6,144	6,336	6,570	6,848	7,175	7,519	7,852	8,174	
 <p>Plinth, Arm Both, High Back</p>	30-35in Wide	LN	P	23	H	30-35W x 25D x 38H	1.4	2.8	4	4,284	4,560	4,715	4,867	5,022	5,177	5,346	5,511	5,711	5,950	6,230	6,525	6,810	7,086	
	36-40in Wide	LN	P	23	H	36-40W x 25D x 38H	1.5	3	4.3	4,484	4,782	4,950	5,115	5,283	5,451	5,635	5,813	6,030	6,288	6,592	6,912	7,221	7,520	
	41-45in Wide	LN	P	23	H	41-45W x 25D x 38H	1.6	3.2	4.7	4,684	5,005	5,186	5,364	5,544	5,725	5,923	6,115	6,349	6,627	6,954	7,298	7,631	7,953	
	46-50in Wide	LN	P	23	H	46-50W x 25D x 38H	1.7	3.6	5.1	4,884	5,236	5,434	5,629	5,826	6,025	6,241	6,452	6,707	7,012	7,370	7,747	8,112	8,465	
	51-55in Wide	LN	P	23	H	51-55W x 25D x 38H	1.8	3.8	5.5	5,084	5,467	5,682	5,893	6,108	6,324	6,559	6,788	7,066	7,397	7,786	8,196	8,592	8,976	
	56-60in Wide	LN	P	23	H	56-60W x 25D x 38H	2	4	5.9	5,284	5,689	5,918	6,142	6,370	6,598	6,847	7,090	7,385	7,736	8,148	8,583	9,003	9,409	

To Order Select Below

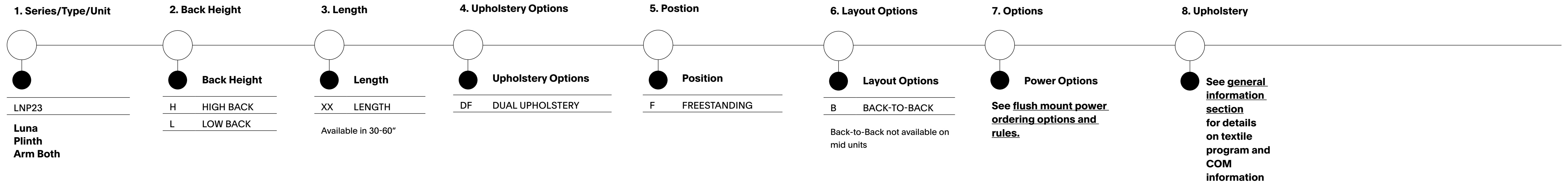

Luna

PLINTH: ARMLESS LEFT OR RIGHT

	WIDTHS	SERIES	TYPE	UNIT	BACK HEIGHT	DIMENSIONS	Yardage Requirements			Textile Upholstery Grades														
							SEAT	BACK	BACK/SEAT	COM	A	B	C	D	E	F	G	H	I	J	K	L	M	
 <p>Plinth, Armless End Left/Right, Low Back</p>	25-30in Wide	LN	P	31/32	L	25-30W x 25D x 31H	1.6	1.3	2.8	2,626	2,818	2,925	3,031	3,138	3,246	3,364	3,478	3,617	3,783	3,977	4,182	4,380	4,572	
	31-35in Wide	LN	P	31/32	L	31-35W x 25D x 31H	1.8	1.5	3.1	2,844	3,058	3,179	3,297	3,418	3,538	3,670	3,798	3,954	4,140	4,357	4,587	4,809	5,024	
	36-40in Wide	LN	P	31/32	L	36-40W x 25D x 31H	1.9	1.6	3.5	3,061	3,298	3,432	3,563	3,696	3,830	3,976	4,118	4,290	4,495	4,737	4,991	5,236	5,474	
	41-45in Wide	LN	P	31/32	L	41-45W x 25D x 31H	2.1	1.7	3.8	3,278	3,538	3,685	3,829	3,975	4,121	4,281	4,437	4,626	4,851	5,116	5,394	5,664	5,925	
	46-50in Wide	LN	P	31/32	L	46-50W x 25D x 31H	2.2	1.9	4	3,495	3,771	3,926	4,078	4,233	4,388	4,557	4,722	4,922	5,161	5,441	5,736	6,021	6,297	
	51-55in Wide	LN	P	31/32	L	51-55W x 25D x 31H	2.4	2	4.3	3,712	4,010	4,178	4,343	4,511	4,679	4,863	5,041	5,258	5,516	5,820	6,140	6,449	6,748	
	56-60in Wide	LN	P	31/32	L	56-60W x 25D x 31H	2.6	2.2	4.7	3,929	4,250	4,431	4,609	4,789	4,970	5,168	5,360	5,594	5,872	6,199	6,543	6,876	7,198	
 <p>Plinth, Armless End Left/Right, High Back</p>	25-30in Wide	LN	P	31/32	H	25-30W x 25D x 38H	1.6	2.4	3.8	2,779	3,039	3,186	3,330	3,476	3,622	3,782	3,938	4,127	4,352	4,617	4,895	5,165	5,426	
	31-35in Wide	LN	P	31/32	H	31-35W x 25D x 38H	1.8	2.6	4.3	3,009	3,307	3,475	3,640	3,808	3,976	4,160	4,338	4,555	4,813	5,117	5,437	5,746	6,045	
	36-40in Wide	LN	P	31/32	H	36-40W x 25D x 38H	1.9	2.9	4.8	3,239	3,568	3,753	3,935	4,120	4,305	4,508	4,704	4,943	5,228	5,563	5,915	6,256	6,586	
	41-45in Wide	LN	P	31/32	H	41-45W x 25D x 38H	2.1	3.2	5.2	3,469	3,829	4,031	4,230	4,432	4,634	4,855	5,071	5,332	5,643	6,009	6,394	6,767	7,127	
	46-50in Wide	LN	P	31/32	H	46-50W x 25D x 38H	2.2	2.8	5	3,699	4,043	4,237	4,428	4,621	4,815	5,027	5,233	5,483	5,781	6,131	6,500	6,857	7,202	
	51-55in Wide	LN	P	31/32	H	51-55W x 25D x 38H	2.4	3	5.3	3,929	4,296	4,503	4,706	4,912	5,119	5,345	5,565	5,831	6,150	6,523	6,917	7,297	7,665	
	56-60in Wide	LN	P	31/32	H	56-60W x 25D x 38H	2.6	3.2	5.8	4,159	4,557	4,781	5,001	5,224	5,448	5,693	5,931	6,220	6,565	6,969	7,396	7,808	8,207	

To Order Select Below

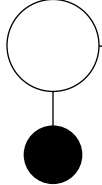
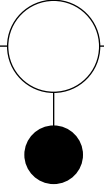
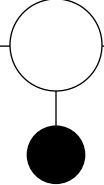
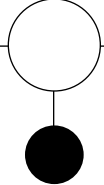
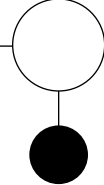
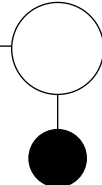
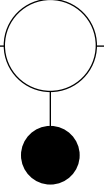
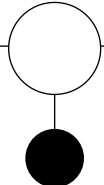
<p>1. Series/Type/Unit</p>  <hr/> <p>LUNA PLINTH ARMLESS LEFT LNP31</p> <hr/> <p>LUNA PLINTH ARMLESS RIGHT LNEP2</p>	<p>2. Back Height</p>  <hr/> <p>Back Height</p> <hr/> <p>H HIGH BACK</p> <hr/> <p>L LOW BACK</p>	<p>3. Width</p>  <hr/> <p>Width</p> <hr/> <p>XX WIDTH</p> <hr/> <p>Available in 25-60"</p>	<p>4. Upholstery Options</p>  <hr/> <p>Upholstery Options</p> <hr/> <p>DF DUAL UPHOLSTERY</p>	<p>5. Postion</p>  <hr/> <p>Position</p> <hr/> <p>F FREESTANDING</p> <hr/> <p>S START</p> <hr/> <p>E END</p>	<p>6. Layout Options</p>  <hr/> <p>Layout Options</p> <hr/> <p>B BACK-TO-BACK</p> <hr/> <p>Back-to-Back not available on mid units</p>	<p>7. Options</p>  <hr/> <p>Power Options</p> <hr/> <p>See flush mount power ordering options and rules.</p> <hr/> <p>Accessory Attachment</p> <hr/> <p>T TRAY/TABLET ARM ATTACHED TO UNIT</p>	<p>8. Upholstery</p>  <hr/> <p>See general information section for details on textile program and COM information</p>
---	--	--	--	--	--	---	---

Plinth Armless Right shown above

Accessory attaches to right side of seat unit. Trays and tablet arm seat mount units can only be used between units. Not available on Armless Right Units

Luna

PLINTH: ROUND INSIDE CORNER

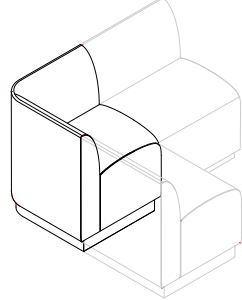
	WIDTH	SERIES	TYPE	UNIT	BACK HEIGHT	DIMENSIONS	Yardage Requirements			Textile Upholstery Grades													
							SEAT	BACK	BACK/SEAT	COM	A	B	C	D	E	F	G	H	I	J	K	L	M
 <p>Plinth, Round Inside Corner, Low Back</p>	25	LN	P	41	L	25W x 25D x 31H	1.3	2	3.2	2,695	2,917	3,042	3,165	3,289	3,414	3,551	3,683	3,845	4,037	4,262	4,500	4,730	4,953
 <p>Plinth, Round Inside Corner, High Back</p>	25	LN	P	41	H	25W x 25D x 38H	1.3	2.8	4	3,084	3,360	3,515	3,667	3,822	3,977	4,146	4,311	4,511	4,750	5,030	5,325	5,610	5,886

To Order Select Below

1. Series/Type/Unit

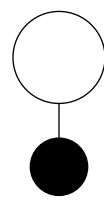

LNP41

**Luna
Plinth
Round Inside Corner**

2. Back Height

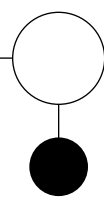

Back Height

H HIGH BACK

L LOW BACK

3. Width

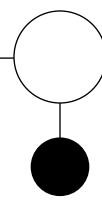

Width

25 WIDTH

4. Upholstery Options

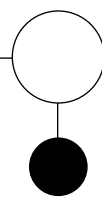

Upholstery Options

DF DUAL UPHOLSTERY

5. Postion

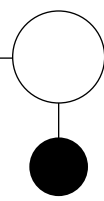

Position

M MID

6. Upholstery

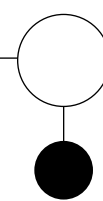

See general information section for details on textile program and COM information

Luna

PLINTH: SQUARE INSIDE CORNER

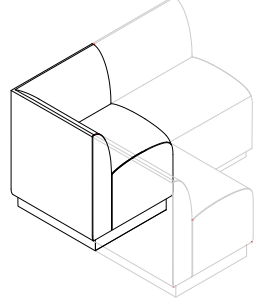
	WIDTH	SERIES	TYPE	UNIT	BACK HEIGHT	DIMENSIONS	Yardage Requirements			Textile Upholstery Grades													
							SEAT	BACK	BACK/SEAT	COM	A	B	C	D	E	F	G	H	I	J	K	L	M
 <p>Plinth, Square Inside Corner, Low Back</p>	25	LN	P	42	L	25W x 25D x 31H	1.3	2.1	3.2	2,763	2,985	3,110	3,233	3,357	3,482	3,619	3,751	3,913	4,105	4,330	4,568	4,798	5,021
 <p>Plinth, Square Inside Corner, High Back</p>	25	LN	P	42	H	25W x 25D x 38H	1.3	2.8	4	2,936	3,212	3,367	3,519	3,674	3,829	3,998	4,163	4,363	4,602	4,882	5,177	5,462	5,738

To Order Select Below

1. Series/Type/Unit

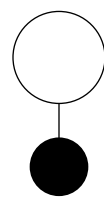

LNP42

**Luna
Plinth
Square Inside Corner**

2. Back Height

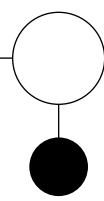

Back Height

H HIGH BACK

L LOW BACK

3. Width

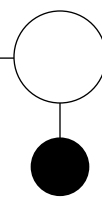

Width

25 WIDTH

4. Upholstery Options

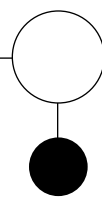

Upholstery Options

DF DUAL UPHOLSTERY

5. Postion

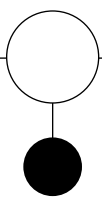

Position

M MID

6. Upholstery

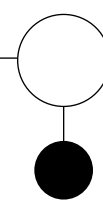

See general information section for details on textile program and COM information

Luna

PLINTH: ROUND OUTSIDE CORNER

	WIDTH	SERIES	TYPE	UNIT	BACK HEIGHT	DIMENSIONS	Yardage Requirements			Textile Upholstery Grades													
							SEAT	BACK	BACK/SEAT	COM	A	B	C	D	E	F	G	H	I	J	K	L	M
 <p>Plinth, Round Outside Corner, Low Back</p>	25	LN	P	51	L	25W x 25D x 31H	1.9	0.5	2.4	1,977	2,138	2,228	2,317	2,407	2,498	2,597	2,693	2,810	2,949	3,112	3,284	3,451	3,612
 <p>Plinth, Round Outside Corner, High Back</p>	25	LN	P	51	H	25W x 25D x 38H	1.9	0.8	2.6	2,111	2,287	2,386	2,484	2,582	2,682	2,790	2,895	3,023	3,175	3,354	3,543	3,725	3,902

To Order Select Below

1. Series/Type/Unit

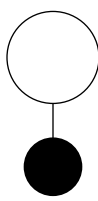

LNP51

**Luna
Plinth
Round Outside Corner**

2. Back Height

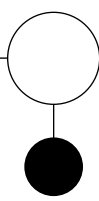

Back Height

H HIGH BACK

L LOW BACK

3. Width

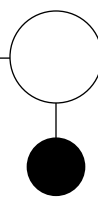

Width

25 WIDTH

4. Upholstery Options

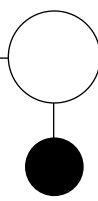

Upholstery Options

DF DUAL UPHOLSTERY

5. Position

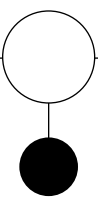

Position

M MID

6. Options

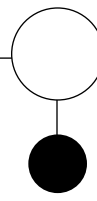

Accessory Attachment

TRAY/TABLET ARM

T ATTACHED TO UNIT

Accessory attaches to right side of seat unit. Trays and tablet arm seat mount units can only be used between units

7. Upholstery

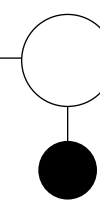

See general information section for details on textile program and COM information

Luna

PLINTH: ROUND END CAP

	WIDTHS	SERIES	TYPE	UNIT	BACK HEIGHT	DIMENSIONS	Yardage Requirements			Textile Upholstery Grades														
							SEAT	BACK	BACK/SEAT	COM	A	B	C	D	E	F	G	H	I	J	K	L	M	
	50-55in Wide	LN	P	52	L	50-55W x 25D x 31H	2.8	0.8	3.6	3,356	3,601	3,739	3,874	4,012	4,150	4,300	4,447	4,624	4,837	5,086	5,348	5,602	5,847	
	56-60in Wide	LN	P	52	L	56-60W x 25D x 31H	3	1	3.9	3,540	3,808	3,959	4,107	4,257	4,408	4,573	4,733	4,927	5,159	5,432	5,719	5,996	6,264	
	61-65in Wide	LN	P	52	L	61-65W x 25D x 31H	3	1.1	4.1	3,724	4,007	4,167	4,323	4,482	4,642	4,816	4,985	5,191	5,436	5,724	6,027	6,320	6,604	
	66-70in Wide	LN	P	52	L	66-70W x 25D x 31H	3	1.4	4.2	3,908	4,199	4,362	4,523	4,686	4,850	5,029	5,203	5,414	5,666	5,962	6,273	6,575	6,866	
	71-75in Wide	LN	P	52	L	71-75W x 25D x 31H	3	1.5	4.4	4,092	4,398	4,570	4,740	4,911	5,084	5,272	5,455	5,677	5,943	6,254	6,582	6,899	7,206	
	50-55in Wide	LN	P	52	H	50-55W x 25D x 38H	2.8	1.1	3.9	3,487	3,755	3,906	4,054	4,204	4,355	4,520	4,680	4,874	5,106	5,379	5,666	5,943	6,211	
	56-60in Wide	LN	P	52	H	56-60W x 25D x 38H	3	1.4	4.2	3,674	3,965	4,128	4,289	4,452	4,616	4,795	4,969	5,180	5,432	5,728	6,039	6,341	6,632	
	61-65in Wide	LN	P	52	H	61-65W x 25D x 38H	3	1.6	4.6	3,860	4,174	4,350	4,524	4,700	4,877	5,070	5,257	5,485	5,757	6,076	6,412	6,737	7,051	
	66-70in Wide	LN	P	52	H	66-70W x 25D x 38H	3	1.8	4.8	4,047	4,376	4,561	4,743	4,928	5,113	5,316	5,512	5,751	6,036	6,371	6,723	7,064	7,394	
	71-75in Wide	LN	P	52	H	71-75W x 25D x 38H	3.1	2.1	5.1	4,233	4,585	4,783	4,978	5,175	5,374	5,590	5,801	6,056	6,361	6,719	7,096	7,461	7,814	

To Order Select Below

1. Series/Type/Unit

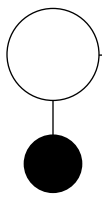

LNP52

**Luna
Plinth
Round End Cap**

2. Back Height

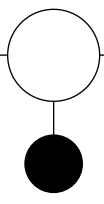

Back Height
H HIGH BACK
L LOW BACK

3. Width

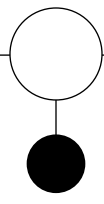

Width
XX WIDTH
Available in 50-75"

4. Upholstery Options

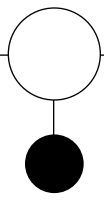

Upholstery Options
DF DUAL UPHOLSTERY

5. Postion

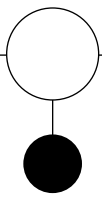

Position
M MID

6. Options

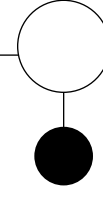

Accessory Attachment
TRAY/TABLET ARM
T ATTACHED TO UNIT

Accessory attaches to right side of seat unit. Trays and tablet arm seat mount units can only be used between units

7. Upholstery

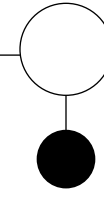

See general information section for details on textile program and COM information

Luna

TRAY TABLE: ROUND OR WIRELESS CHARGING

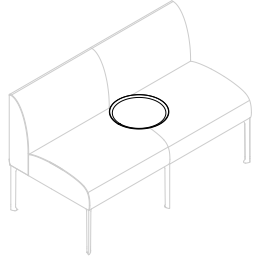
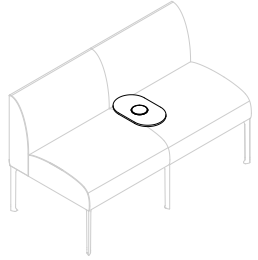
	SERIES	TYPE	DIMENSIONS	PRICE
Tray Table, Round Tray Table 	LN	71	13W x 13D	503
Tray Table, Wireless Charging Tray 	LN	72	8W x 13D	840

To Order Select Below

1. Series/Type

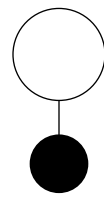

- LN71 ROUND TRAY TABLE
- LN72 WIRELESS CHARGING TRAY

2. Top Finish

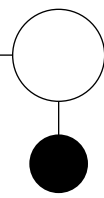

Wood Finish

- SW81 WHITE OAK
- SW83 MAPLE
- SW85 WALNUT **+70**
- SW87 OPAQUE BLACK

Only applicable for Wireless Charging Tray

3. Finish

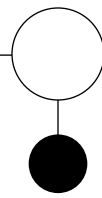

Standard Powder Coated Metal

- | | |
|--------------------|-------------------|
| BL BLUE | NK NICKEL |
| BM BLACK MATTE | NV NAVY |
| BR BRASS | OR ORANGE |
| BT BLACK TWILIGHT | PY PALE YELLOW |
| CP CHAMPAGNE | RD RED |
| DB DARK BRONZE | RO RED ORANGE |
| DG DARK GRAY | RR RUSTY RED |
| DP DUSTY PINK | SB SOFT BLUE |
| FG FOREST GREEN | SD SAND |
| LG LIGHT GRAY | TC TERRACOTTA |
| MG MEADOW GREEN | TP TAUPE |
| MK MILK | TS TEXTURED SLATE |
| MS METALLIC SILVER | YL YELLOW |

Only applicable for Round Tray Table

Luna

TABLET ARM: UNDER MOUNT

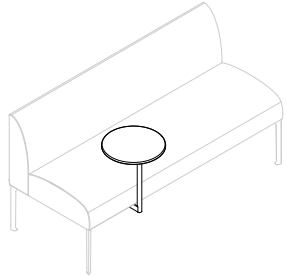
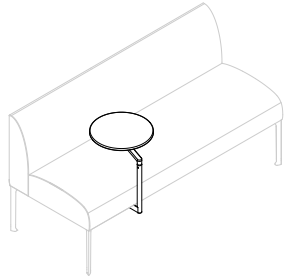
	SERIES	TYPE	DIMENSIONS	PRICE
Tray Table, Tablet Arm, Under Single 	LN	75	14W x 14D	800
Tray Table, Tablet Arm, Under Dual 	LN	76	14W x 14D	800

To Order Select Below

1. Series/Type

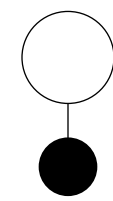

LN75	UNDER MOUNT SINGLE SWIVEL
LN72	UNDER MOUNT DUAL SWIVEL

2. Top Finish

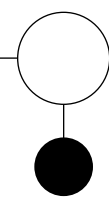

Wood Finish

SW81	WHITE OAK
SW83	MAPLE
SW85	WALNUT +70
SW87	OPAQUE BLACK

3. Finish

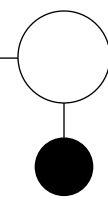

Standard Powder Coated Metal

BL	BLUE	NK	NICKEL
BM	BLACK MATTE	NV	NAVY
BR	BRASS	OR	ORANGE
BT	BLACK TWILIGHT	PY	PALE YELLOW
CP	CHAMPAGNE	RD	RED
DB	DARK BRONZE	RO	RED ORANGE
DG	DARK GRAY	RR	RUSTY RED
DP	DUSTY PINK	SB	SOFT BLUE
FG	FOREST GREEN	SD	SAND
LG	LIGHT GRAY	TC	TERRACOTTA
MG	MEADOW GREEN	TP	TAUPE
MK	MILK	TS	TEXTURED SLATE
MS	METALLIC SILVER	YL	YELLOW

Luna

TABLET ARM: SEAT MOUNT

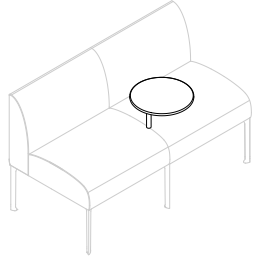
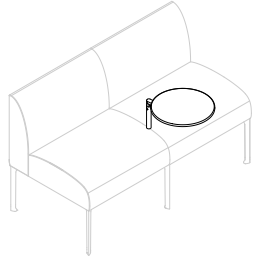
	SERIES	TYPE	DIMENSIONS	PRICE
Tray Table, Tablet Arm, Seat Single 	LN	77	14W x 14D	800
Tray Table, Tablet Arm, Seat Dual 	LN	78	14W x 14D	800

To Order Select Below

1. Series/Type

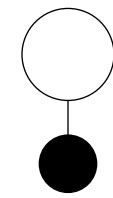

- LN77 SEAT MOUNT SINGLE SWIVEL
- LN78 SEAT MOUNT DUAL SWIVEL

2. Top Finish

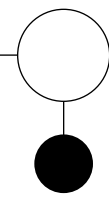

Wood Finish

- SW81 WHITE OAK
- SW83 MAPLE
- SW85 WALNUT **+70**
- SW87 OPAQUE BLACK

3. Finish

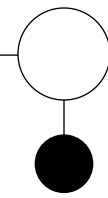

Standard Powder Coated Metal

- | | |
|--------------------|-------------------|
| BL BLUE | NK NICKEL |
| BM BLACK MATTE | NV NAVY |
| BR BRASS | OR ORANGE |
| BT BLACK TWILIGHT | PY PALE YELLOW |
| CP CHAMPAGNE | RD RED |
| DB DARK BRONZE | RO RED ORANGE |
| DG DARK GRAY | RR RUSTY RED |
| DP DUSTY PINK | SB SOFT BLUE |
| FG FOREST GREEN | SD SAND |
| LG LIGHT GRAY | TC TERRACOTTA |
| MG MEADOW GREEN | TP TAUPE |
| MK MILK | TS TEXTURED SLATE |
| MS METALLIC SILVER | YL YELLOW |

Luna

PLANTER: SINGLE

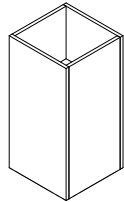
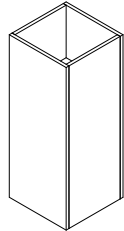
	SERIES	TYPE	HEIGHT	DIMENSIONS	PRICE
Planter, Plinth, Single, Low Back 	LNP	6P1A	LB	15W x 15D x 31H	2,034
Planter, Plinth, Single, High Back 	LNP	6P1A	HB	15W x 15D x 38H	2,320

To Order Select Below

1. Series/Unit

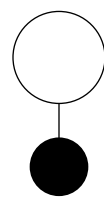

LNP6P1A

**Luna
Planter Single
Plinth**

Plinth planters are not designed to be exposed, they must be surrounded by seating units or placed against a wall. Elevated planters will be available Q2 2024.

2. Planter Height

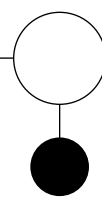

Planter Height

LB LOW BACK

HB HIGH BACK

3. Finish

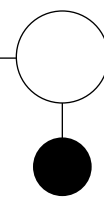

Finish

LM09 BLACK

Luna

PLANTER: DOUBLE

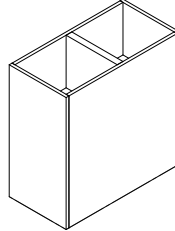
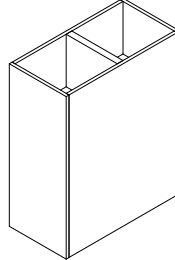
	SERIES	TYPE	HEIGHT	DIMENSIONS	PRICE
Planter, Plinth, Double, Low Back 	LNP	6P2A	LB	15W x 30D x 31H	2,872
Planter, Plinth, Double, High Back 	LNP	6P2A	HB	15W x 30D x 38H	3,241

To Order Select Below

1. Series/Unit

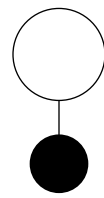

LNP6P2A

**Luna
Planter Double
Enclosed**

Plinth planters are not designed to be exposed, they must be surrounded by seating units or placed against a wall. Elevated planters will be available Q2 2024.

2. Planter Height

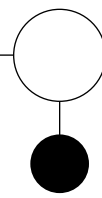

Planter Height

LB LOW BACK

HB HIGH BACK

3. Finish

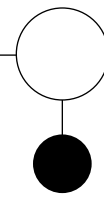

Finish

LM09 BLACK

stylex

Mark 2

PRICE LIST

Effective November 01, 2023

General Information

GENERAL INFORMATION

Terms

Net 30 days from date of invoice.
FOB Delanco, NJ

Damaged Shipments

All Stylex products are carefully inspected before they are packed in sturdy cartons designed to satisfy shipping requirements. Stylex is not responsible for damage in shipment. The transportation company assumes responsibility for delivering products to you in good condition when the bill of lading is signed. You protect yourself by refusing shipments showing damage or shortage until transportation company has noted on the delivery sheet the extent of damage or shortage. Concealed damage should be reported to the carrier as soon as discovered, but not later than 15 days after receiving shipment.

Return/Restocking Policy

Return shipments will not be accepted unless specifically authorized by Stylex in writing. The Return Authorization number should be clearly marked on the carton. The customer returning Stylex products is responsible for return shipping costs. Merchandise must be returned unused. Returned merchandise is subject to a 35% restocking fee.

Specials/Customs

Modifications to standard products will be considered for large runs. Contact Stylex for more information.

Design Changes

In keeping with modern manufacturing advances, Stylex reserves the right to incorporate minor modifications and design changes in products without notice.

Cancellation Policy

No charge prior to production except for inventory specifically requisitioned to fulfill the particular order. After production has begun, only actual costs incurred, including labor and material, will be billed to the customer.

WARRANTY

Except as provided below, Stylex warrants exclusively to the original Purchaser of our product that all parts, under normal use and service, will be free from defects in workmanship and material for a period of ten (10) years from the date of purchase. "Normal use and service" means that the product will be used in a typical office environment for 40-45 hours per week.

This warranty is subject to the following limitations, exclusions and provisions:

Wood components of plywood stacking chairs
(such as Brooks and Welcome)
5 years

Upholstery
(including mesh used for Click, F4, Insight, and Zephyr Mesh)
3 years

SAVA Mesh
10 years

COM Upholstery
No warranty
Stylex makes every effort to ensure that the COM Upholstery it approves is suitable for the intended use. Nevertheless, we will not warrant, and assume no responsibility for, the durability or tailoring quality of any COM or COL. If you have any concerns about the ultimate appearance of any covering, please order an upholstered sample.

Painted Stack Chair Frames
No Warranty
We will not warrant the finish of painted stack chair frames against damage from stacking. We recommend ordering chrome frames for chairs that will be stacked.

Felt Glides
No warranty
Due to the different surfaces on which felt glides may be used, we cannot warrant their durability over time.

If this product fails during normal use and service within the applicable warranty period (other than through normal wear and tear), please send a description of the relevant part and the nature of the defect, together with proof of purchase of the product, to Stylex at: Customer Service. c/o Stylex, P.O. Box 5038, Delanco, NJ 08075. PLEASE DO NOT RETURN PARTS OR THE PRODUCT TO STYLEX UNLESS INSTRUCTED TO DO SO BY STYLEX. Stylex will, at its option, either repair or replace the product or the part found defective by Stylex completely without charge for materials or labor. Purchaser may be required (at the option of Stylex) to return to Stylex at Purchaser's expense any defective part with all freight or shipping charges prepaid. The foregoing warranty shall be void if the product has been altered or repaired (other than by Stylex). The warranty does not cover damage to the product caused by accident, neglect, misuse, abuse, modification to the product by anyone other than Stylex or damage caused by use of the product for a purpose other than that for which it was designed. This warranty extends only to the original Purchaser of the product.

No Other Warranties

This warranty is in lieu of all other warranties, expressed or implied, including, but not limited to, implied warranties of merchantability and fitness for a particular purpose. The rights and remedies provided herein are the exclusive rights and remedies of the original purchaser of the product.

No Liability For Damages

In no event shall Stylex or its suppliers be responsible or liable for any special, indirect, consequential, or incidental damages. In no event shall the liability of Stylex exceed the actual purchase price paid to Stylex for the product.

Out of Warranty Products

For all products no longer covered by our warranty, please refer to our Design for Durability and Upgradability Policy. Contact Customer Service if you would like to purchase any replaceable components to further extend the life of any Stylex seating product. This warranty applies to all Stylex products purchased on April 13, 2018, and thereafter.

PRODUCT TAKE BACK PROGRAM

At Stylex, responsible stewardship of our products extends beyond their initial use. Our Product Take Back Program provides a practical solution for the end of our products' intended life cycle.

Through our partnership with ANEW, a 501(c)(3) nonprofit organization, we offer clients a comprehensive take-back solution for surplus office furniture and materials, regardless of their condition. ANEW's mission aligns with ours—to connect surplus resources with non-profits, public agencies, and underserved communities, minimizing landfill impact and maximizing corporate social responsibility.

By repurposing surplus items, we strengthen community networks and reduce environmental impact. Stylex proudly supports ANEW, integrating this partnership into our strategic sales strategy since 2014. Learn more at www.anewfound.org.

Initiate a Product Take Back through ANEW by emailing Stylex at info@stylexdesign.com. For additional end-of-life recovery options, refer to our Product Disassembly Instructions and End of Life Recovery Options documents, available in the Resources section of each product on our website. Together, let's build a sustainable future.

FREIGHT PROGRAM

Stylex offers a Guaranteed Freight Program, which provides the purchaser the ability to determine shipping and handling charges at the time of order. Freight charges will be calculated as a percentage of the net product price and added to the invoice at the time of shipment. The continental United States has been divided into three zones. Please use the map below to determine the freight charges for the product's destination. There is a minimum freight charge of \$150.

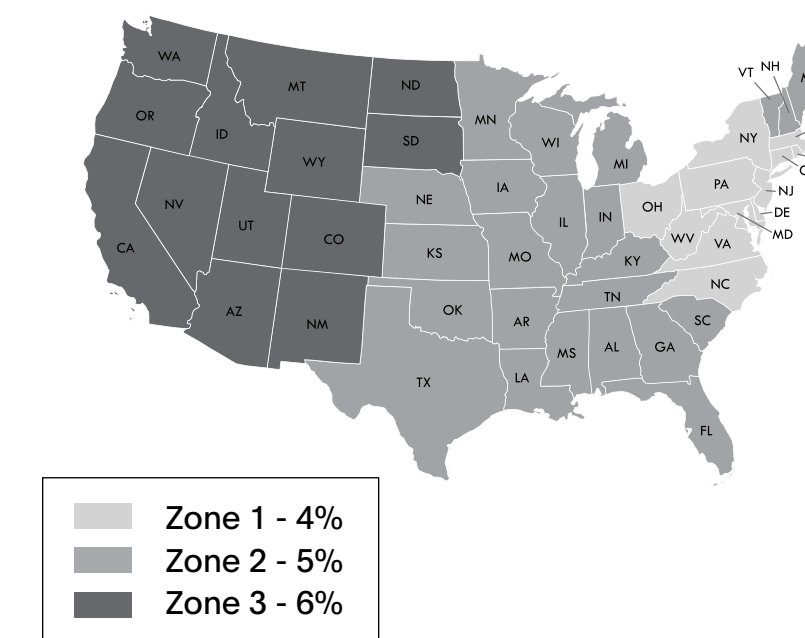

ZONE 1 - 4%

Connecticut
Delaware
New York
New Jersey
Maryland
Massachusetts
North Carolina
Ohio
Pennsylvania
Rhode Island
Virginia
Washington D.C.
West Virginia

ZONE 2 - 5%

Alabama
Arkansas
Canada, Ontario
Canada, Quebec
Florida
Georgia
Iowa
Illinois
Indiana
Kansas
Kentucky
Louisiana
Nebraska
New Hampshire
Oklahoma
Maine
Michigan
Minnesota
Missouri
Mississippi
South Carolina
Tennessee
Texas
Vermont
Wisconsin

ZONE 3 - 6%

Arizona
California
Colorado
Idaho
Montana
Nevada
New Mexico
North Dakota
Oregon
South Dakota
Utah
Washington
Wyoming

Quote Per Project

Alaska
Hawaii
Canada
(outside Ontario & Quebec)
Mexico

General Information

TEXTILE PARTNERS & APPROVALS

Textile Partners

To customize your furniture performance needs and design vision, Stylex offers a wide selection of in-graded leathers and textiles from Grades A through Y. We've partnered with leading manufacturers on the options, focusing on color, price, durability, and construction. To view our partners and explore our digital carded program with broadly approved textiles, visit [this page](#). We stand by these textiles: They're tried and tested, and will effortlessly fit into any design aesthetic.

Textile Approvals

To view Stylex Approved Textile documents to determine specific product approval status, refer to our Product Tested Textiles documents, available in the Resources section of each product on our website.

CAL 117 AND 133 COMPLIANCE

CAL 117-2013

All Stylex seating satisfies the requirements of CAL 117-2013 so long as one of our standard or in-graded textiles is applied. COM textiles cannot be so guaranteed. Please contact the supplier of COM's directly to determine the fire retardancy of any COM supplied to us.

CAL 133

Most Stylex seating can be ordered to meet the requirements of CAL 133. When ordering, simply specify "CAL 133 compliance required". The upcharge for this option is \$54 list per yard. Please refer to the COM yardage of each model to determine the number of yards required. We do frequently require full-scale burn tests in order to certify CAL 133 before an order will be accepted. Such burn tests may increase normal lead times and do carry additional charges. Please contact customer service for details.

CUSTOMER'S OWN MATERIAL/LEATHER

Customer's own material (COM) and customer's own leather (COL) will generally be upholstered at the price designated in each product's price list. Please be advised, however, that we specifically reserve the right to charge a higher price when we determine that special circumstances, such as unusual repeats or challenging materials, present themselves. All orders for custom coverings must be approved by Stylex before they will be accepted for production. To submit proposed textile for approval, please use the COM form [here](#).

Special Note:

We assume no responsibility for the durability or tailoring quality of any COM or COL. Directional covers in particular may not meet your satisfaction due to the design of certain products. Please be advised that COM and COL orders are not subject to return. If you have doubts about the ultimate appearance of certain coverings, please order a sample done with that specific COM or COL. In addition, while we inspect textiles for mill imperfections, some are difficult to recognize. We cannot be responsible for defects, color inaccuracies, dye lot variations, or other flaws.

Under no circumstances will we be responsible for COM shortages, flaws, or other such problems. Finally, it is not our responsibility to police the receipt of COM's in order to meet delivery deadlines, and we assume our customers are aware of any undue delay in the shipment of their COM textiles.

COM textile and COL leather should be sent prepaid to: Stylex

**Attn: COM/COL - [Your PO #]
740 Coopertown Road
Delanco, NJ 08075**

Clearly mark textile or leather with the dealer's name, purchase order number, and furniture model number of the item to be covered. Actual furniture orders should include the same information, as well as a description of the textile or leather, including pattern and color number, in order to provide a cross reference.

Yardage requirements shown in the price list are based on non-directional goods of 54" width. Textiles less than 54" wide or those requiring matching (stripes, prints, or large patterned designs) call for additional yardage. We will be happy to supply yardage requirements for large quantities where economies may be realized.

Add the following yardage for stripes, plaids, or patterns with repeats:

Textile Width	Plain Textile	2-14" Repeat	15-24" Repeat	25-27" Repeat	28-36" Repeat
54"	0%	10%	15%	20%	25%
50"	10%	20%	25%	30%	35%
48"	15%	25%	30%	35%	40%
45"	40%	50%	55%	60%	65%
36"	50%	60%	65%	70%	75%

COM/COL FORM

To avoid delay in processing COM orders we request that you submit a sample of your COM textile stapled to this form which can be downloaded [here](#). If a textile has a stripe or design, the size of the repeat should be indicated. Please indicate the textile supplier's name, textile number, and color. Also indicate the Stylex product on which the textile will be used.

The textile supplier must indicate on his shipping labels the dealer name and purchase order number as well as the Stylex model number.

Please Note:

No order may be entered into production or have a shipping date assigned until all related COM is received at the factory.



CENTER OF STRIPE OR DESIGN

TOP	TOP
-----	-----

1. Size of Repeat

2. Textile Supplier

3. Textile Number

4. Color

5. Stylex Product

Mark 2

COLORS, MATERIALS, AND FINISHES

POWDER COATED PAINTED METAL

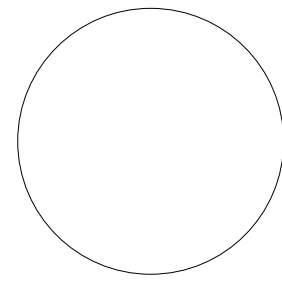

MILK
(MK)

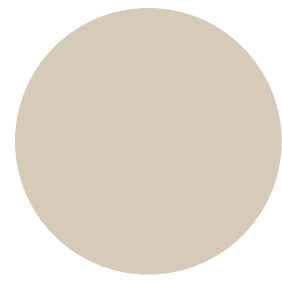

SAND
(SD)

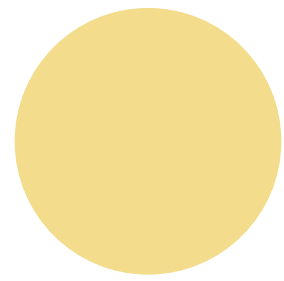

PALE YELLOW
(PY)

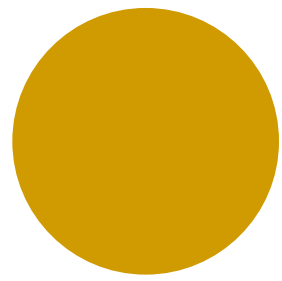

YELLOW
(YL)

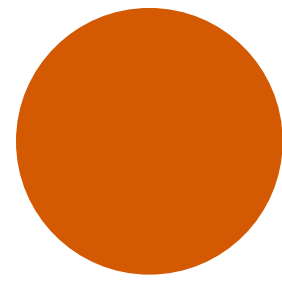

ORANGE
(OR)

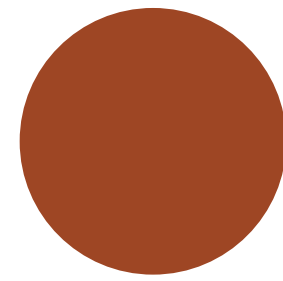

TERRACOTTA
(TC)

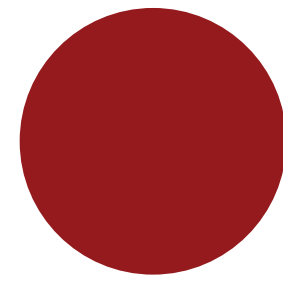

RED
(RD)

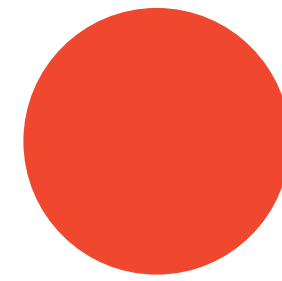

RED ORANGE
(RO)

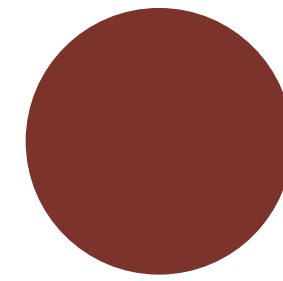

RUSTY RED
(RR)

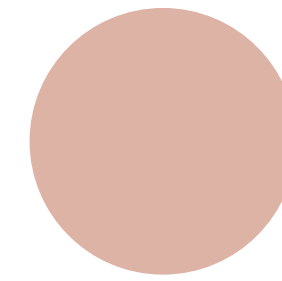

DUSTY PINK
(DP)

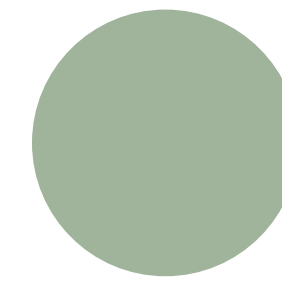

MEADOW GREEN
(MG)

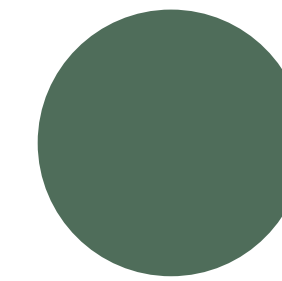

FOREST GREEN
(FG)

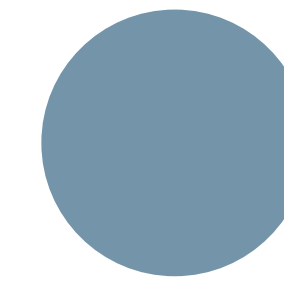

SOFT BLUE
(SB)

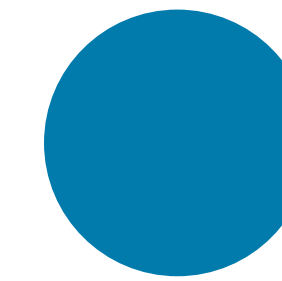

BLUE
(BL)

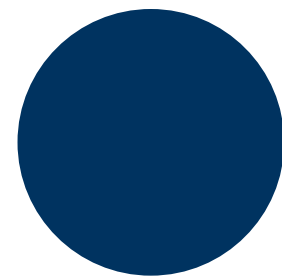

NAVY
(NV)

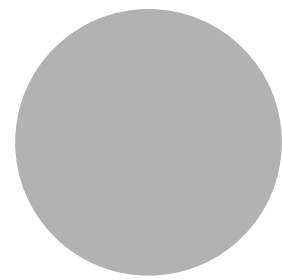

LIGHT GRAY
(LG)



CHAMPAGNE
(CP)

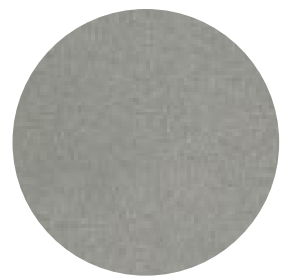

METALLIC SILVER
(MS)

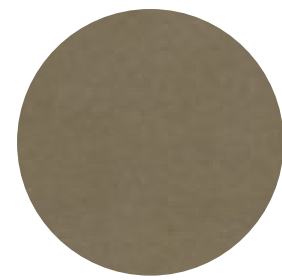

NICKEL
(NK)

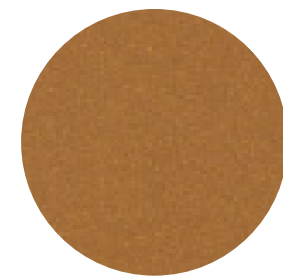

BRASS
(BR)

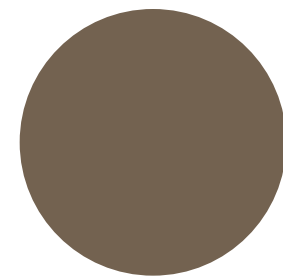

TAUPE
(TP)

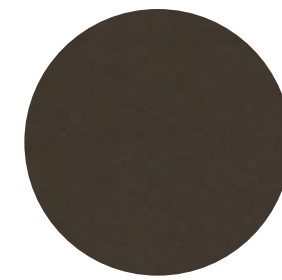

DARK BRONZE
(DB)

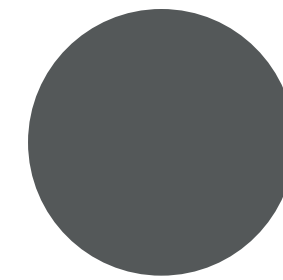

DARK GRAY
(DG)

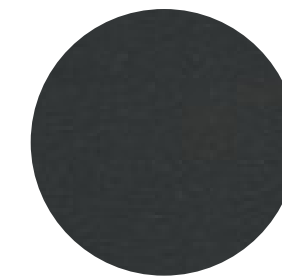

TEXTURED SLATE
(TS)

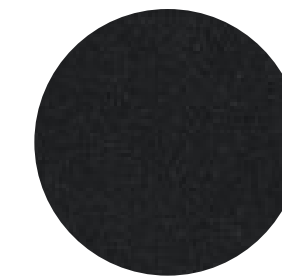

BLACK TWILIGHT
(BT)

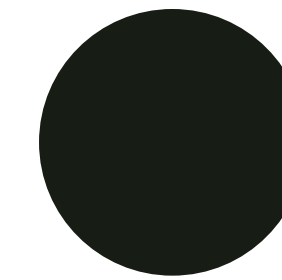

BLACK MATTE
(BM)

Mark 2

SPECIFICATION GUIDE: OVERVIEW AND DIMENSIONS

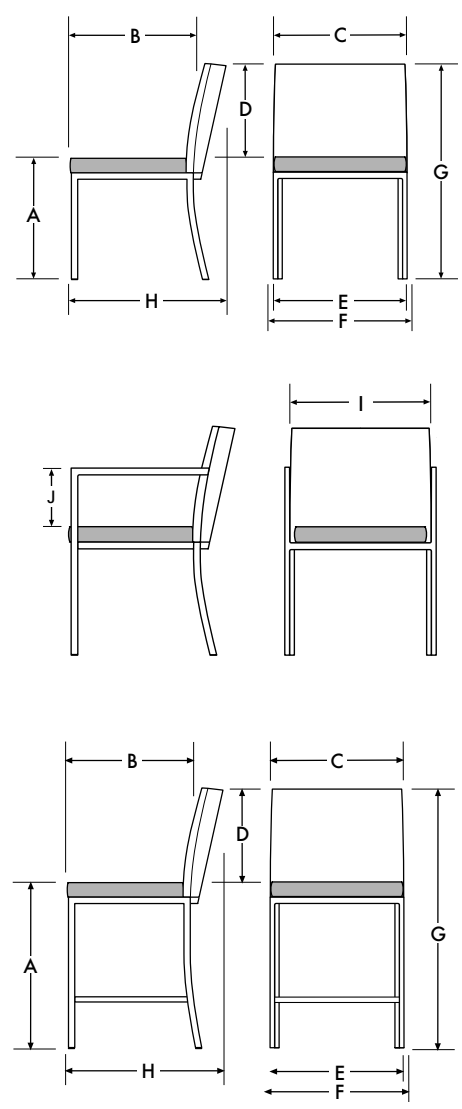
OVERVIEW	STACKING		NON-STACKING			
<p>Dimensions</p> <ul style="list-style-type: none"> A. Seat Height B. Seat Depth C. Seat Width D. Back Height E. Back Width F. Overall Width G. Maximum Overall Height H. Maximum Overall Depth I. Distance Between Arms J. Arm Height 	<p>Armless Chair</p> <ul style="list-style-type: none"> A. 18 B. 18 C. 18 D. 13.5 E. 20 F. 20 G. 31 H. 22 	<p>Arm Chair</p> <ul style="list-style-type: none"> A. 18 B. 18 C. 18 D. 13.5 E. 20 F. 21.5 G. 31 H. 22 I. 20 J. 7.5 	<p>Armless Chair</p> <ul style="list-style-type: none"> A. 18 B. 18 C. 18 D. 13.5 E. 18 F. 18 G. 31 H. 22 	<p>Arm Chair</p> <ul style="list-style-type: none"> A. 18 B. 18 C. 20 D. 13.5 E. 20 F. 21.5 G. 31 H. 22 I. 20 J. 7.5 	<p>Counter Stool</p> <ul style="list-style-type: none"> A. 25 B. 17 C. 18 D. 13.5 E. 18 F. 18 G. 38 H. 23 	<p>Bar Stool</p> <ul style="list-style-type: none"> A. 29.5 B. 17 C. 18 D. 13.5 E. 18 F. 18 G. 42.5 H. 23
<p>A. Full Stack on Floor (4 chairs)</p>	<p>A. 20W x 27.5D x 40H</p>	<p>A. 21.5W x 27.5D x 40H</p>				

PRODUCT INFORMATION

Design

Mark Goetz

Construction

Backs consist of upholstered, curved plywood. Steel frames support upholstered seats incorporating plywood and flexible webbing with polyurethane foam..

Glides

Black plastic glides are standard.

Stacking

Arm and Armless stacking chairs stack 4 high on the floor. Chairs with optional arm caps should not be stacked. Appropriate care must be exercised when stacking powder coated chairs.

Use

Designed for indoor use only.

Performance Standards

Manufactured to comply with:

- ANSI/BIFMA X5.1 General-Purpose Office Chairs - Tests

Environment

Greenguard Certified

OPTIONS

Dual Upholstery

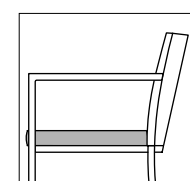

Contrasting Thread

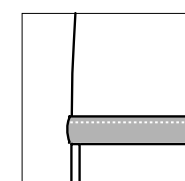

Upholstered Arm Cap

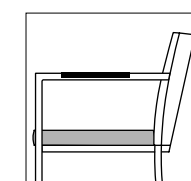

Mark 2

SPECIFICATION GUIDE: HOW TO ORDER

MODEL CODE BREAKDOWN

Sample Model Code: **MK5410CTBMCOM**

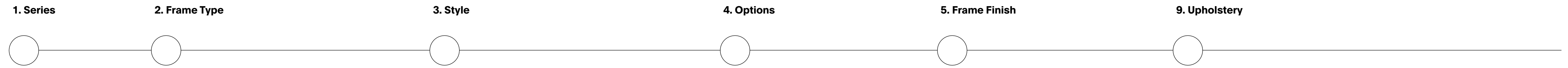

MK

5

410

CT

BM

COM

Series

MK MARK 2

Frame Type

- 1 CHAIR, STACKING, ARMLESS
- 2 CHAIR, STACKING, ARM
- 3 CHAIR, NON-STACKING, ARMLESS
- 5 CHAIR, NON-STACKING, ARM
- 7 BAR STOOL
- 9 COUNTER STOOL

Style

- 410 STANDARD UPHOLSTERED SEAT AND BACK
- 410DF DUAL UPHOLSTERED SEAT AND BACK

Options

- CT CONTRASTING THREAD
- UC UPHOLSTERED ARM CAPS

Standard Powder Coated Metal

- BL BLUE
- BM BLACK MATTE
- BR BRASS
- BT BLACK TWILIGHT
- CP CHAMPAGNE
- DB DARK BRONZE
- DG DARK GRAY
- DP DUSTY PINK
- FG FOREST GREEN
- LG LIGHT GRAY
- MG MEADOW GREEN
- MK MILK
- MS METALLIC SILVER
- NK NICKEL
- NV NAVY
- OR ORANGE
- PY PALE YELLOW
- RD RED
- RO RED ORANGE
- RR RUSTY RED
- SB SOFT BLUE
- SD SAND
- TC TERRACOTTA
- TP TAUPE
- TS TEXTURED SLATE
- YL YELLOW

Textile Grades

- COM CUSTOMER'S OWN MATERIAL
- A GRADE A
- B GRADE B
- C GRADE C
- D GRADE D
- E GRADE E
- F GRADE F
- G GRADE G
- H GRADE H
- I GRADE I
- J GRADE J
- K GRADE K
- L GRADE L
- M GRADE M

Leather Grades

- COL CUSTOMER'S OWN LEATHER
- W GRADE W
- X GRADE X
- Y GRADE Y
- E1 GRADE E1
- E2 GRADE E2

Note: Select highest grade in the case of dual upholstery

Mark 2

CHAIR: STACKING

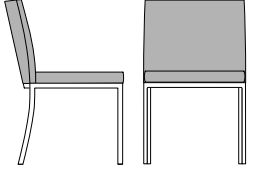
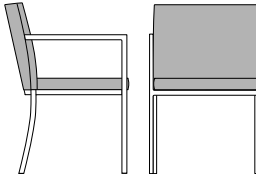
TITLE	SERIES	FRAME	STYLE	DIMENSIONS	COM YDG	COL SQFT	Textile Upholstery Grades										Leather Upholstery Grades							
							COM					COL					W	X	Y	E1	E2			
							A	B	C	D	E	F	G	H	I	J						K	L	M
Chair, Stacking, Upholstered Seat & Back 	MK	1	410	20W x 22D x 31H	1.2	21	1,146	1,223	1,300	1,371	1,448	1,526	1,605	1,697	1,792	1,898	2,055	2,184	2,310	1,636	1,717	1,953	2,601	2,901
Chair, Stacking, Upholstered Seat & Back, Arm 	MK	2	410	21.5W x 22D x 31H	1.2	21	1,348	1,421	1,496	1,570	1,646	1,725	1,804	1,898	1,990	2,095	2,252	2,382	2,508	1,832	1,913	2,150	2,801	3,103

To Order Select Below

1. Series/Frame

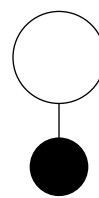

- MK1
- Mark 2 Chair, Stacking, Armless**
- MK2
- Mark 2 Chair, Stacking, Arm**

2. Style

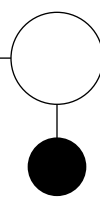

- Style**
- 410 STANDARD UPHOLSTERED SEAT AND BACK
 - 410DF DUAL UPHOLSTERED SEAT AND BACK

3. Options

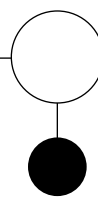

- Options**
- CT CONTRASTING THREAD
 - UC UPHOLSTERED ARM CAPS **+100**
- Upholstered arm caps in leather and vinyl only.
Chairs with arm caps should not be stacked.

4. Frame Finish

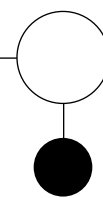

- Standard Powder Coated Metal**
- | | |
|--------------------|-------------------|
| BL BLUE | NK NICKEL |
| BM BLACK MATTE | NV NAVY |
| BR BRASS | OR ORANGE |
| BT BLACK TWILIGHT | PY PALE YELLOW |
| CP CHAMPAGNE | RD RED |
| DB DARK BRONZE | RO RED ORANGE |
| DG DARK GRAY | RR RUSTY RED |
| DP DUSTY PINK | SB SOFT BLUE |
| FG FOREST GREEN | SD SAND |
| LG LIGHT GRAY | TC TERRACOTTA |
| MG MEADOW GREEN | TP TAUPE |
| MK MILK | TS TEXTURED SLATE |
| MS METALLIC SILVER | YL YELLOW |

Appropriate care must be exercised when stacking powder coated chairs.

5. Upholstery

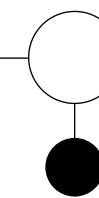

See general information section for details on textile program and COM/COL information.

When pricing models with more than one fabric, the higher grade fabric will determine the overall grade of the specific product.

Mark 2

CHAIR: NON-STACKING

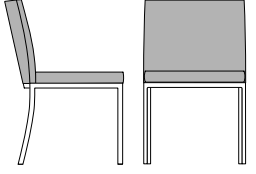
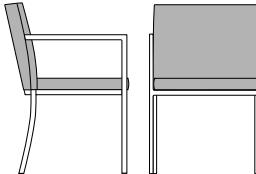
TITLE	SERIES	FRAME	STYLE	DIMENSIONS	COM YDG	COL SQFT	Textile Upholstery Grades										Leather Upholstery Grades							
							COM					COL					W	X	Y	E1	E2			
							A	B	C	D	E	F	G	H	I	J						K	L	M
Chair, Non-Stacking, Upholstered Seat & Back 	MK	3	410	18W x 22D x 31H	1.2	21	1,146	1,223	1,300	1,371	1,448	1,526	1,605	1,697	1,792	1,898	2,055	2,184	2,310	1,636	1,717	1,953	2,601	2,901
Chair, Non-Stacking, Upholstered Seat & Back, Arm 	MK	5	410	21.5W x 22D x 31H	1.2	21	1,348	1,421	1,496	1,570	1,646	1,725	1,804	1,898	1,990	2,095	2,252	2,382	2,508	1,832	1,913	2,150	2,801	3,103

To Order Select Below

1. Series/Frame

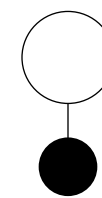

MK3

**Mark 2
Chair, Non-Stacking,
Armless**

MK5

**Mark 2
Chair, Non-Stacking,
Arm**

2. Style

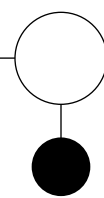

Style

410 STANDARD UPHOLSTERED SEAT AND BACK

410DF DUAL UPHOLSTERED SEAT AND BACK

3. Options

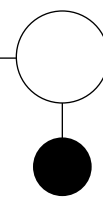

Options

CT CONTRASTING THREAD

UC UPHOLSTERED ARM CAPS **+100**

Upholstered arm caps in leather and vinyl only.
Chairs with arm caps should not be stacked.

4. Frame Finish

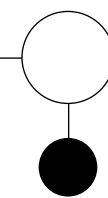

Standard Powder Coated Metal

BL BLUE

BM BLACK MATTE

BR BRASS

BT BLACK TWILIGHT

CP CHAMPAGNE

DB DARK BRONZE

DG DARK GRAY

DP DUSTY PINK

FG FOREST GREEN

LG LIGHT GRAY

MG MEADOW GREEN

MK MILK

MS METALLIC SILVER

NK NICKEL

NV NAVY

OR ORANGE

PY PALE YELLOW

RD RED

RO RED ORANGE

RR RUSTY RED

SB SOFT BLUE

SD SAND

TC TERRACOTTA

TP TAUPE

TS TEXTURED SLATE

YL YELLOW

Appropriate care must be exercised when stacking powder coated chairs.

5. Upholstery

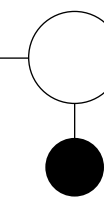

See general information section for details on textile program and COM/COL information.

When pricing models with more than one fabric, the higher grade fabric will determine the overall grade of the specific product.

Mark 2

STOOL

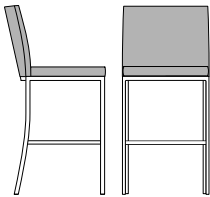
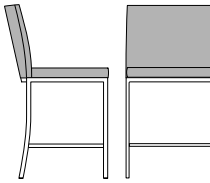
TITLE	SERIES	FRAME	STYLE	DIMENSIONS	COM YDG	COL SQFT	Textile Upholstery Grades										Leather Upholstery Grades							
							COM A	B	COL C	D	E	F	G	H	I	J	K	L	M	W	X	Y	E1	E2
Bar Stool, Upholstered Seat & Back 	MK	7	410	18W x 23D x 42.5H	1.1	18	1,547	1,614	1,684	1,748	1,821	1,892	1,962	2,049	2,134	2,231	2,374	2,492	2,607	1,982	2,057	2,267	2,855	3,126
Counter Stool, Upholstered Seat & Back 	MK	9	410	18W x 23D x 38H	1.1	18	1,547	1,614	1,684	1,748	1,821	1,892	1,962	2,049	2,134	2,231	2,374	2,492	2,607	1,982	2,057	2,267	2,855	3,126

To Order Select Below

1. Series/Frame

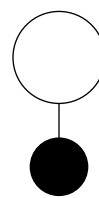

- MK7
- Mark 2 Bar Stool**
- MK9
- Mark 2 Counter Stool**

2. Style

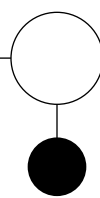

- Style**
- 410 STANDARD UPHOLSTERED SEAT AND BACK
 - 410DF DUAL UPHOLSTERED SEAT AND BACK

3. Options

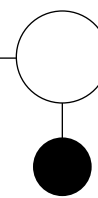

- Options**
- CT CONTRASTING THREAD
 - UC UPHOLSTERED ARM CAPS **+100**
- Upholstered arm caps in leather and vinyl only.
Chairs with arm caps should not be stacked.

4. Frame Finish

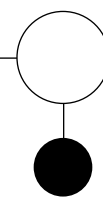

- Standard Powder Coated Metal**
- | | |
|--------------------|-------------------|
| BL BLUE | NK NICKEL |
| BM BLACK MATTE | NV NAVY |
| BR BRASS | OR ORANGE |
| BT BLACK TWILIGHT | PY PALE YELLOW |
| CP CHAMPAGNE | RD RED |
| DB DARK BRONZE | RO RED ORANGE |
| DG DARK GRAY | RR RUSTY RED |
| DP DUSTY PINK | SB SOFT BLUE |
| FG FOREST GREEN | SD SAND |
| LG LIGHT GRAY | TC TERRACOTTA |
| MG MEADOW GREEN | TP TAUPE |
| MK MILK | TS TEXTURED SLATE |
| MS METALLIC SILVER | YL YELLOW |

Appropriate care must be exercised when stacking powder coated chairs.

5. Upholstery

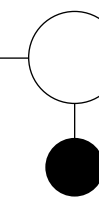

See general information section for details on textile program and COM/COL information.

When pricing models with more than one fabric, the higher grade fabric will determine the overall grade of the specific product.

stylex

Metrum



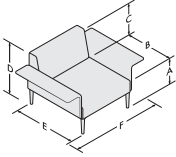
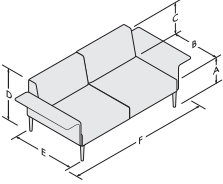
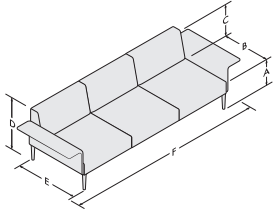
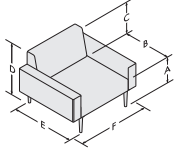
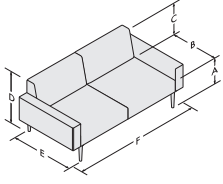
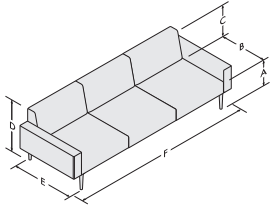
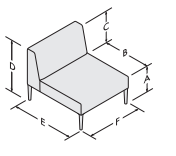
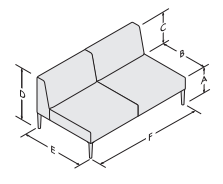
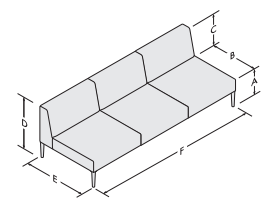

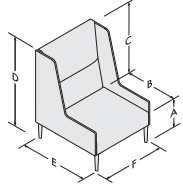
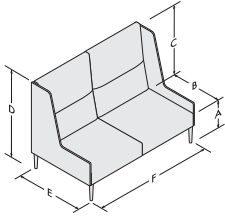
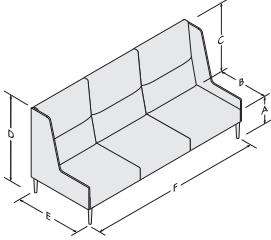
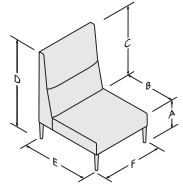
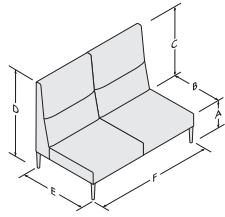
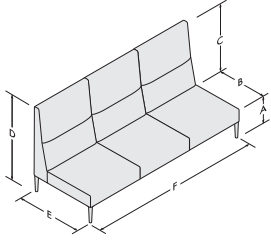
PRICE LIST
Effective January 8, 2024

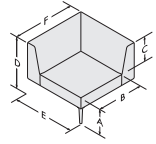
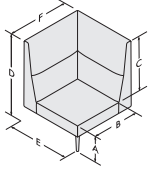
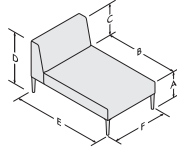
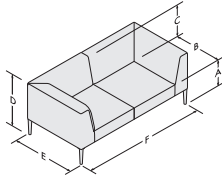
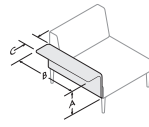
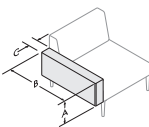
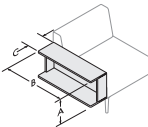
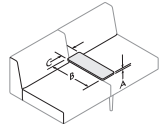
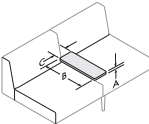
Dimensions / Overview	Single	Double	Triple	General Information
<p>Low-Back with Cantilever Arms</p> <p>A. Seat Height B. Seat Depth C. Back Height D. Overall Height E. Overall Depth F. Overall Length</p>	<p>A. 16" B. 23.5" C. 12" D. 28" E. 33.75" F. 48"</p> 	<p>A. 16" B. 23.5" C. 12" D. 28" E. 33.75" F. 77.75"</p> 	<p>A. 16" B. 23.5" C. 12" D. 28" E. 33.75" F. 107.5"</p> 	<p>Design Stylex</p> <p>Legs Metrum is available with cast aluminum or wood legs. Cast aluminum legs may be powder coated in a variety of finishes, or ordered as polished cast aluminum. Wood legs are available in maple, white oak, and walnut. Adjustable glides are standard.</p> <p>Arms Metrum offers two categories of arms – end arms that can only be added to the outside ends of a unit, and mid-arms that can be added between units in a continuous layout.</p> <p>Configuration While Metrum offers traditional standalone units (single seat, double seat, and triple seat), it is at the same time fundamentally flexible. The modular armless seats, corners, arms, and tables have all been designed to encourage creation of a wide variety of setups. Units next to each other in a continuous layout share a mid-leg that supports both units. To ensure clarity when ordering modular set-ups, it is critical that line items should be listed in the order in which they will be connected from left end (seated perspective) to right end.</p> <p>Testing Manufactured to comply with ANSI/BIFMA X5.4 Public and Lounge Seating Standard</p> <p>Environment Greenguard Certified</p>
<p>Low-Back with Standard Arms</p> <p>A. Seat Height B. Seat Depth C. Back Height D. Overall Height E. Overall Depth F. Overall Length</p>	<p>A. 16" B. 23.5" C. 12" D. 28" E. 33.75" F. 41.25"</p> 	<p>A. 16" B. 23.5" C. 12" D. 28" E. 33.75" F. 71"</p> 	<p>A. 16" B. 23.5" C. 12" D. 28" E. 33.75" F. 100.75"</p> 	<p>Configuration While Metrum offers traditional standalone units (single seat, double seat, and triple seat), it is at the same time fundamentally flexible. The modular armless seats, corners, arms, and tables have all been designed to encourage creation of a wide variety of setups. Units next to each other in a continuous layout share a mid-leg that supports both units. To ensure clarity when ordering modular set-ups, it is critical that line items should be listed in the order in which they will be connected from left end (seated perspective) to right end.</p> <p>Testing Manufactured to comply with ANSI/BIFMA X5.4 Public and Lounge Seating Standard</p> <p>Environment Greenguard Certified</p>
<p>Low-Back Armless</p> <p>A. Seat Height B. Seat Depth C. Back Height D. Overall Height E. Overall Depth F. Overall Length</p>	<p>A. 16" B. 23.5" C. 12" D. 28" E. 33.75" F. 29.75"</p> 	<p>A. 16" B. 23.5" C. 12" D. 28" E. 33.75" F. 59.5"</p> 	<p>A. 16" B. 23.5" C. 12" D. 28" E. 33.75" F. 89.25"</p> 	<p>Configuration While Metrum offers traditional standalone units (single seat, double seat, and triple seat), it is at the same time fundamentally flexible. The modular armless seats, corners, arms, and tables have all been designed to encourage creation of a wide variety of setups. Units next to each other in a continuous layout share a mid-leg that supports both units. To ensure clarity when ordering modular set-ups, it is critical that line items should be listed in the order in which they will be connected from left end (seated perspective) to right end.</p> <p>Testing Manufactured to comply with ANSI/BIFMA X5.4 Public and Lounge Seating Standard</p> <p>Environment Greenguard Certified</p>

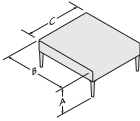
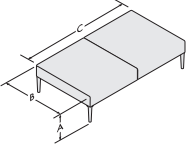
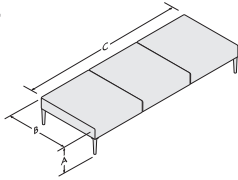
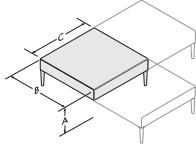
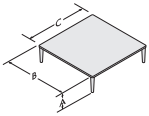
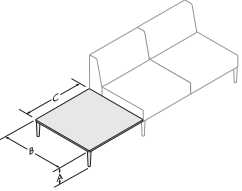
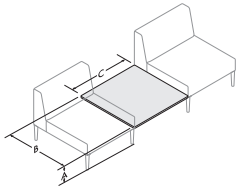
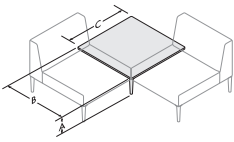
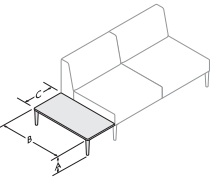
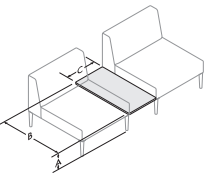
Dimensions / Overview	Single	Double	Triple	General Information
<p>High-Back with Privacy Arms</p> <p>A. Seat Height B. Seat Depth C. Back Height D. Overall Height E. Overall Depth F. Overall Length</p>	<p>A. 16" B. 23.5" C. 28.5" D. 44.5" E. 33.75" F. 33.75"</p> 	<p>A. 16" B. 23.5" C. 28.5" D. 44.5" E. 33.75" F. 63.75"</p> 	<p>A. 16" B. 23.5" C. 28.5" D. 44.5" E. 33.75" F. 93.75"</p> 	<p>Design Stylex</p> <p>Legs Metrum is available with cast aluminum or wood legs. Cast aluminum legs may be powder coated in a variety of finishes, or ordered as polished cast aluminum. Wood legs are available in maple, white oak, and walnut. Adjustable glides are standard..</p>
<p>High-Back Armless</p> <p>A. Seat Height B. Seat Depth C. Back Height D. Overall Height E. Overall Depth F. Overall Length</p>	<p>A. 16" B. 23.5" C. 28.5" D. 44.5" E. 33.75" F. 29.75"</p> 	<p>A. 16" B. 23.5" C. 28.5" D. 44.5" E. 33.75" F. 59.5"</p> 	<p>A. 16" B. 23.5" C. 28.5" D. 44.5" E. 33.75" F. 89.25"</p> 	<p>Configuration While Metrum offers traditional standalone units (single seat, double seat, and triple seat), it is at the same time fundamentally flexible. The modular armless seats, corners, arms, and tables have all been designed to encourage creation of a wide variety of setups. Units next to each other in a continuous layout share a mid-leg that supports both units. To ensure clarity when ordering modular set-ups, it is critical that line items should be listed in the order in which they will be connected from left end (seated perspective) to right end.</p>
				<p>Testing Manufactured to comply with ANSI/BIFMA X5.4 Public and Lounge Seating Standard</p> <p>Environment Greenguard certified.</p>

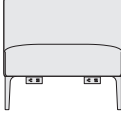
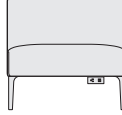
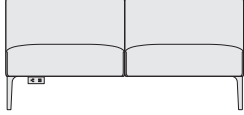
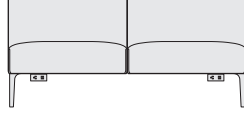
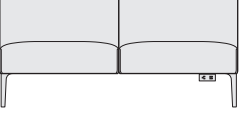
Dimensions / Overview				General Information
Low/High-Back Corner A. Seat Height B. Seat Depth C. Back Height D. Overall Height E. Overall Depth F. Overall Length	Low-Back Corner A. 16" B. 23.5" C. 12" D. 28" E. 33.75" F. 33.75" 	High-Back Corner A. 16" B. 23.5" C. 28.5" D. 44.5" E. 33.75" F. 33.75" 		Design Stylex Legs Metrum is available with cast aluminum or wood legs. Cast aluminum legs may be powder coated in a variety of finishes, or ordered as polished cast aluminum. Wood legs are available in maple, white oak, and walnut. Adjustable glides are standard. Arms Metrum offers two categories of arms – end arms that can only be added to the outside ends of a unit, and mid-arms that can be added between units in a continuous layout. Configuration While Metrum offers traditional standalone units (single seat, double seat, and triple seat), it is at the same time fundamentally flexible. The modular armless seats, corners, arms, and tables have all been designed to encourage creation of a wide variety of setups. Units next to each other in a continuous layout share a mid-leg that supports both units. To ensure clarity when ordering modular set-ups, it is critical that line items should be listed in the order in which they will be connected from left end (seated perspective) to right end. Testing Manufactured to comply with ANSI/BIFMA X5.4 Public and Lounge Seating Standard Environment Greenguard certified.
Low-Back Chaise A. Seat Height B. Seat Depth C. Back Height D. Overall Height E. Overall Depth F. Overall Length	A. 18" B. 38.5" C. 12" D. 28" E. 48.75" F. 29.75" 			
Settee Double A. Seat Height B. Seat Depth C. Back Height D. Overall Height E. Overall Depth F. Overall Length	A. 16" B. 23.5" C. 12" D. 28" E. 33.75" F. 66.875" 			
Arms A. Arm Height B. Arm Depth C. Arm Width	Cantilever A. 13.5" B. 33.25" C. 9.125" 	Standard A. 13" B. 33.75" C. 5.75" 	Bookshelf A. 14" B. 33" C. 10" 	
	Mid Arm Wood A. 3" above seat B. 22" C. 7.5" 	Mid Arm Upholstered A. 4.25" above seat B. 22.5" C. 8" 		

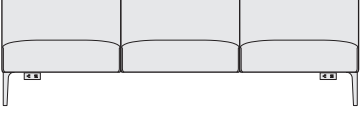
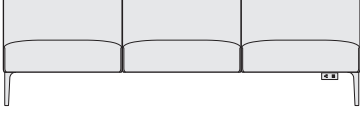
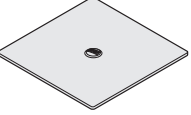
Dimensions / Overview					General Information
Bench A. Bench Height B. Bench Depth C. Bench Width	Bench Single A. 16" B. 33.75" C. 29.75" 	Bench Double A. 16" B. 33.75" C. 59.5" 	Bench Triple A. 16" B. 33.75" C. 89.25" 	Bench Corner A. 16" B. 33.75" C. 33.75" 	Design Stylex Legs Metrum is available with cast aluminum or wood legs. Cast aluminum legs may be powder coated in a variety of finishes, or ordered as polished cast aluminum. Wood legs are available in maple, white oak, and walnut. Adjustable glides are standard. Tables Caesarsstone, solid surface, and wood tables are available. Configuration While Metrum offers traditional standalone units (single seat, double seat, and triple seat), it is at the same time fundamentally flexible. The modular armless seats, corners, arms, and tables have all been designed to encourage creation of a wide variety of setups. Units next to each other in a continuous layout share a mid-leg that supports both units. To ensure clarity when ordering modular set-ups, it is critical that line items should be listed in the order in which they will be connected from left end (seated perspective) to right end. Testing Manufactured to comply with ANSI/BIFMA X5.4 Public and Lounge Seating Standard and ANSI/BIFMA S5.5 Desk and Table Products Standard Environment Greenguard certified.
Full Tables A. Height B. Depth C. Width	Full Stand-Alone Table A. 9.25 - 9.5" B. 33.5" C. 33.5" 	Full End Table A. 9.25 - 9.5" B. 33.5" C. 33.5" 	Full Mid Table A. 9.25 - 9.5" B. 33.5" C. 33.5" 	Full Corner Table A. 9.25 - 9.5" B. 33.5" C. 33.5" 	
Half Tables A. Height B. Depth C. Width	Half End Table A. 9.25 - 9.5" B. 33.5" C. 20" 	Half Mid Table A. 9.25 - 9.5" B. 33.5" C. 20" 			

	Right Side	Double	Left Side	General Information
Single Seating Power Port Option(s)				<p>Capabilities & Mounting Options Power units contain one USB-A port, one USB-C port, and a standard, grounded 3-prong electrical outlet. Available for surface mount in tables or undermounted on the front of seat units by either the left or right leg. Table surface mount power is designated by (S) in the model code. Power mounted under seat units is designated by (U) in the model code.</p> <p>Cord Length All power units are available with 10' cords.</p> <p>Colors Power units are available in black (B), white (W), and gray (G).</p> <p>Location Table surface mount power is centered on tables. Power mounted under seat units is located under the front edge next to the left leg (1), right leg (2), or both (3) from a seated perspective.</p> <p>Examples S1B - Table surface, 10' cord, Black U1W2 - Under Seat, 10' cord, White, Right Side.</p> <p>Restrictions Power is not available on corner seats or arms.</p>
Double Seating Power Port Option(s)				
Triple Seating Power Port Option(s)				
Full/Half Tables Power Port Option				

Power Port Ordering

Power Options Seating

	U1B1 Under Seat, 10' Cord, Black, Left +519
	U1B2 Under Seat, 10' Cord, Black, Right +519
	U1B3 Under Seat, 10' Cord, Black, Left & Right +1,037
	U1W1 Under Seat, 10' Cord, White, Left +519
	U1W2 Under Seat, 10' Cord, White, Right +519
	U1W3 Under Seat, 10' Cord, White, Left & Right +1,037
	U1G1 Under Seat, 10' Cord, Gray, Left +519
	U1G2 Under Seat, 10' Cord, Gray, Right +519
	U1G3 Under Seat, 10' Cord, Gray, Left & Right +1,037

Power Options Tables

	S1B Table Surface, 10' Cord, Black +513
	S1W Table Surface, 10' Cord, White +513
	S1G Table Surface, 10' Cord, Gray +513

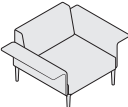
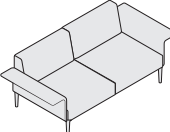
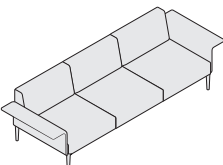
					C.O.M Fabric Upholstery Grades														
	Series	Model	Dimensions	Ydg.	C.O.M	A	B	C	D	E	F	G	H	I	J	K	L	M	
	Low-Back Single with Cantilever Arms	MT	11B41	28"H x 33.75"D x 48"W	3.8	3,332	3,615	3,764	3,917	4,069	4,223	4,394	4,559	4,757	5,017	5,324	5,631	5,936	6,242
	Low-Back Double with Cantilever Arms	MT	12B41	28"H x 33.75"D x 77.75"W	5.9	4,967	5,402	5,635	5,866	6,102	6,339	6,602	6,857	7,161	7,560	8,034	8,506	8,971	9,445
	Low-Back Triple with Cantilever Arms	MT	13B41	28"H x 33.75"D x 107.5"W	7.9	6,420	7,000	7,311	7,621	7,932	8,250	8,601	8,939	9,346	9,879	10,508	11,139	11,760	12,390

To Order Follow Steps 1-8

1. Section Type	2. Arm Choice	3. Arm Finish Choices	4. Welt Cord Options	5. Power Options	6. Leg Choice	7. Leg Finished Choices	8. Textile
<p>MT</p> <p>11 Low-Back Single 12 Low-Back Double 13 Low-Back Triple</p>	<p>B41</p> <p>Cantilever Arm</p>	<p>BL Blue BM Black Matte BR Brass BT Black Twilight CP Champagne DB Dark Bronze DG Dark Gray DP Dusty Pink FG Forest Green LG Light Gray MG Meadow Green MK Milk MS Metallic Silver</p> <p>NK Nickel NV Navy OR Orange PY Pale Yellow RD Red RO Red Orange RR Rusty Red SB Soft Blue SD Sand TC Terracotta TP Taupe TS Textured Slate YL Yellow</p>	<p>Welt Cord Options</p> <p>Requires an additional 0.25 yds of fabric. Not available on quilted fabric.</p> <p>W3 Welt Cord on Seats and Backs +79 (per seat/back)</p>	<p>Refer to power port ordering steps for seating on page 6.</p>	<p>A Cast Aluminum legs with adjustable glides</p> <p>W Wood legs with adjustable glides</p> 	<p>AL Cast Aluminum- Polished</p> <p>Cast Aluminum- Standard Powder Paint</p> <p>BL Blue BM Black Matte BR Brass BT Black Twilight CP Champagne DB Dark Bronze DG Dark Gray DP Dusty Pink FG Forest Green LG Light Gray MG Meadow Green MK Milk MS Metallic Silver</p> <p>NK Nickel NV Navy OR Orange PY Pale Yellow RD Red RO Red Orange RR Rusty Red SB Soft Blue SD Sand TC Terracotta TP Taupe TS Textured Slate YL Yellow</p>	<p>Wood</p> <p>81 White Oak +775 83 Natural Maple +667 85 Walnut +873</p> <p>Yardages provided are for non-directional fabrics that are applied railroaded. Directional fabrics may require additional yardage. Thick quilted fabrics will be need to be verified and may be handled as a custom order.</p> <p>Refer to Stylex swatch cards and separately published in-graded fabric program to determine grades.</p> <p>See general information section in the main price list for CAL 133 information.</p>

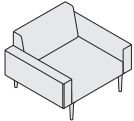
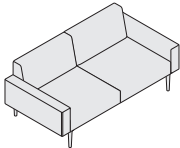
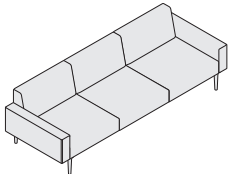
					C.O.M Fabric Upholstery Grades														
	Series	Model	Dimensions	Ydg.	C.O.M	A	B	C	D	E	F	G	H	I	J	K	L	M	
	Low-Back Single with Standard Arms	MT	11B44	28"H x 33.75"D x 41.25"W	5.5	3,017	3,430	3,650	3,872	4,093	4,322	4,571	4,811	5,100	5,482	5,929	6,380	6,822	7,269
	Low-Back Double with Standard Arms	MT	12B44	28"H x 33.75"D x 71"W	7.6	4,652	5,217	5,521	5,822	6,126	6,438	6,779	7,107	7,505	8,026	8,639	9,254	9,858	10,471
	Low-Back Triple with Standard Arms	MT	13B44	28"H x 33.75"D x 100.75"W	9.6	6,105	6,818	7,197	7,577	7,957	8,350	8,777	9,192	9,690	10,345	11,114	11,887	12,646	13,417

To Order Follow Steps 1-7

<p>1. Section Type</p> <p>MT</p> <ul style="list-style-type: none"> 11 Low-Back Single 12 Low-Back Double 13 Low-Back Triple 	<p>2. Arm Choice</p> <p>B44</p> <p>Standard Arm</p>	<p>3. Welt Cord Options</p> <p>Requires an additional 0.25 yds of fabric. Not available on quilted fabric.</p> <p>W3 Welt Cord on Seats and Backs +79 (per seat/back)</p> <p>W5 Welt Cord on Seats, Backs and Arms +200 (arms) +79 (per seat/back)</p>	<p>4. Power Options</p> <p>Refer to power port ordering steps for seating on page 6.</p>	<p>5. Leg Choice</p> <p>A Cast Aluminum legs with adjustable glides</p> <p>W Wood legs with adjustable glides</p> 	<p>6. Leg Finished Choices</p> <p>AL Cast Aluminum- Polished</p> <p>Cast Aluminum- Standard Powder Paint</p> <table border="0"> <tr><td>BL Blue</td><td>NK Nickel</td></tr> <tr><td>BM Black Matte</td><td>NV Navy</td></tr> <tr><td>BR Brass</td><td>OR Orange</td></tr> <tr><td>BT Black Twilight</td><td>PY Pale Yellow</td></tr> <tr><td>CP Champagne</td><td>RD Red</td></tr> <tr><td>DB Dark Bronze</td><td>RO Red Orange</td></tr> <tr><td>DG Dark Gray</td><td>RR Rusty Red</td></tr> <tr><td>DP Dusty Pink</td><td>SB Soft Blue</td></tr> <tr><td>FG Forest Green</td><td>SD Sand</td></tr> <tr><td>LG Light Gray</td><td>TC Terracotta</td></tr> <tr><td>MG Meadow Green</td><td>TP Taupe</td></tr> <tr><td>MK Milk</td><td>TS Textured Slate</td></tr> <tr><td>MS Metallic Silver</td><td>YL Yellow</td></tr> </table>	BL Blue	NK Nickel	BM Black Matte	NV Navy	BR Brass	OR Orange	BT Black Twilight	PY Pale Yellow	CP Champagne	RD Red	DB Dark Bronze	RO Red Orange	DG Dark Gray	RR Rusty Red	DP Dusty Pink	SB Soft Blue	FG Forest Green	SD Sand	LG Light Gray	TC Terracotta	MG Meadow Green	TP Taupe	MK Milk	TS Textured Slate	MS Metallic Silver	YL Yellow	<p>7. Textile</p> <p>Wood</p> <table border="0"> <tr><td>81 White Oak</td><td>+775</td></tr> <tr><td>83 Natural Maple</td><td>+667</td></tr> <tr><td>85 Walnut</td><td>+873</td></tr> </table> <p>Yardages provided are for non-directional fabrics that are applied railroaded. Directional fabrics may require additional yardage. Thick quilted fabrics will be need to be verified and may be handled as a custom order.</p> <p>Refer to Stylex swatch cards and separately published in-graded fabric program to determine grades.</p> <p>See general information section in the main price list for CAL 133 information.</p>	81 White Oak	+775	83 Natural Maple	+667	85 Walnut	+873
BL Blue	NK Nickel																																					
BM Black Matte	NV Navy																																					
BR Brass	OR Orange																																					
BT Black Twilight	PY Pale Yellow																																					
CP Champagne	RD Red																																					
DB Dark Bronze	RO Red Orange																																					
DG Dark Gray	RR Rusty Red																																					
DP Dusty Pink	SB Soft Blue																																					
FG Forest Green	SD Sand																																					
LG Light Gray	TC Terracotta																																					
MG Meadow Green	TP Taupe																																					
MK Milk	TS Textured Slate																																					
MS Metallic Silver	YL Yellow																																					
81 White Oak	+775																																					
83 Natural Maple	+667																																					
85 Walnut	+873																																					

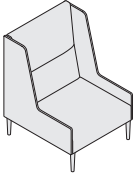
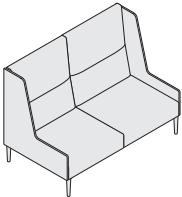
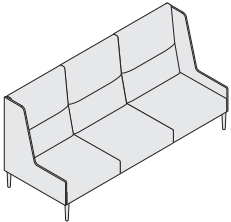
					C.O.M Fabric Upholstery Grades														
	Series	Model	Dimensions	Ydg.	C.O.M	A	B	C	D	E	F	G	H	I	J	K	L	M	
	High-Back Single with Privacy Arms	MT	21B43	44.5"H x 33.75"D x 33.75"W	6.6	3,392	3,879	4,137	4,398	4,657	4,926	5,220	5,501	5,842	6,300	6,817	7,344	7,863	8,391
	High-Back Double with Privacy Arms	MT	22B43	44.5"H x 33.75"D x 63.5"W	9.5	5,330	6,027	6,398	6,773	7,143	7,526	7,947	8,353	8,840	9,480	10,235	10,992	11,738	12,492
	High-Back Triple with Privacy Arms	MT	23B43	44.5"H x 33.75"D x 93.25"W	12.3	7,146	8,047	8,527	9,009	9,489	9,984	10,527	11,052	11,681	12,509	13,484	14,462	15,423	16,398

To Order Follow Steps 1-7

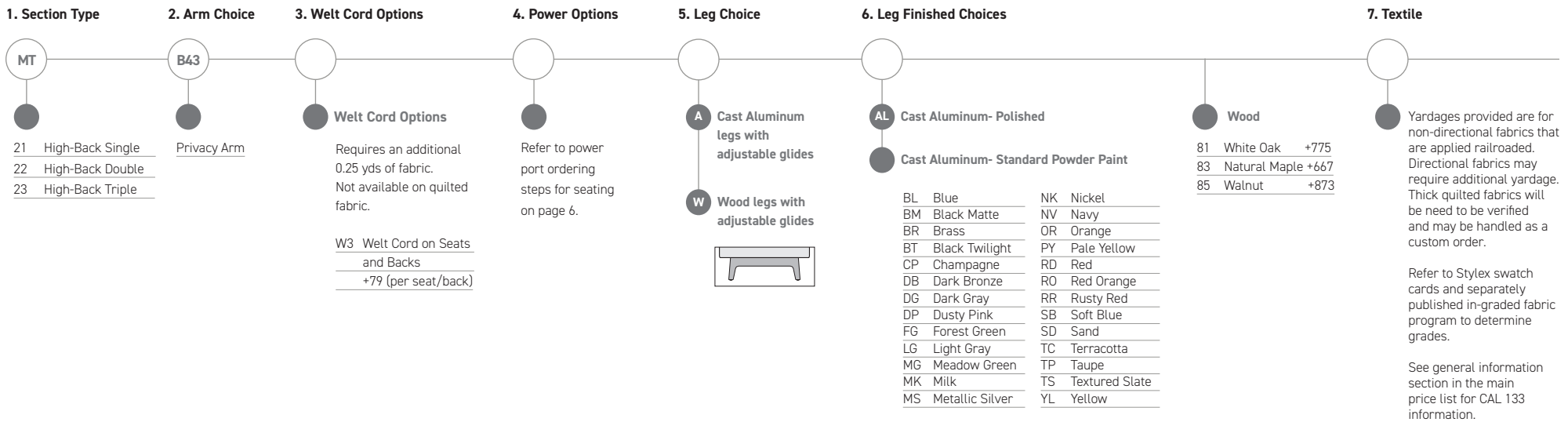

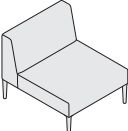
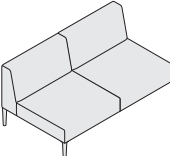
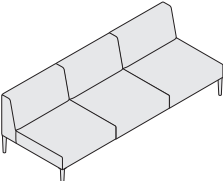
					C.O.M Fabric Upholstery Grades														
	Series	Model	Dimensions	Ydg.	C.O.M	A	B	C	D	E	F	G	H	I	J	K	L	M	
	Low-Back Single	MT	11	28"H x 33.75"D x 29.75"W	2.7	2,120	2,315	2,420	2,526	2,629	2,737	2,856	2,970	3,107	3,287	3,500	3,713	3,922	4,134
	Low-Back Double	MT	12	28"H x 33.75"D x 59.5"W	4.8	3,755	4,104	4,290	4,476	4,662	4,853	5,063	5,266	5,511	5,831	6,210	6,587	6,958	7,337
	Low-Back Triple	MT	13	28"H x 33.75"D x 89.25"W	6.8	5,208	5,703	5,967	6,230	6,494	6,765	7,062	7,350	7,697	8,150	8,685	9,220	9,747	10,283

To Order Follow Steps 1-7

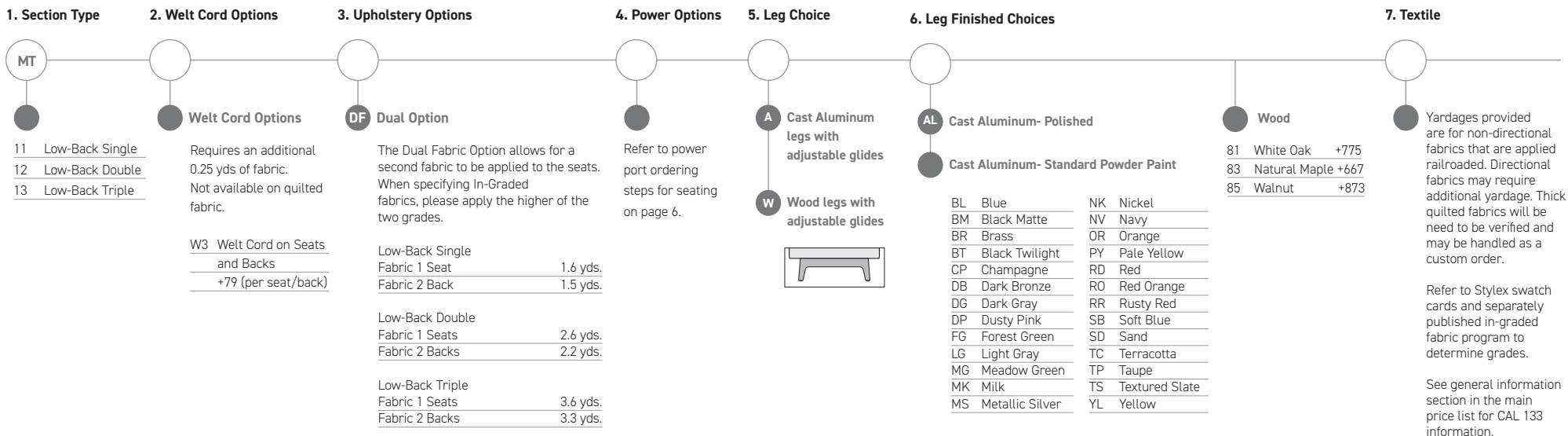

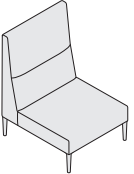
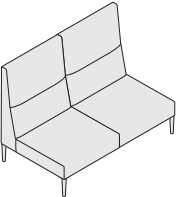
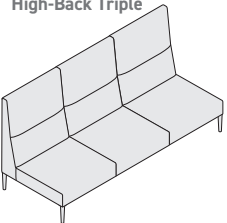
					C.O.M Fabric Upholstery Grades														
	Series	Model	Dimensions	Ydg.	C.O.M	A	B	C	D	E	F	G	H	I	J	K	L	M	
	High-Back Single	MT	21	44.5"H x 33.75"D x 29.75"W	3.3	2,665	2,904	3,032	3,159	3,289	3,421	3,565	3,704	3,872	4,091	4,352	4,612	4,868	5,127
	High-Back Double	MT	22	44.5"H x 33.75"D x 59.5"W	6.2	4,603	5,054	5,293	5,535	5,774	6,023	6,293	6,555	6,870	7,283	7,771	8,260	8,740	9,230
	High-Back Triple	MT	23	44.5"H x 33.75"D x 89.25"W	9.0	6,420	7,074	7,422	7,771	8,121	8,480	8,873	9,254	9,713	10,311	11,021	11,729	12,427	13,134

To Order Follow Steps 1-7

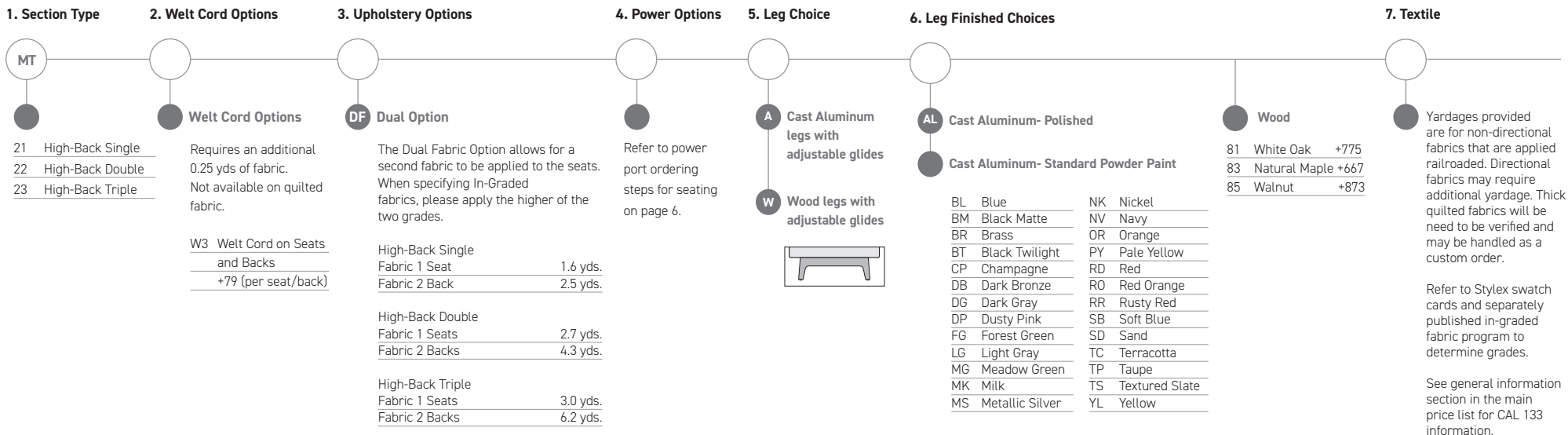

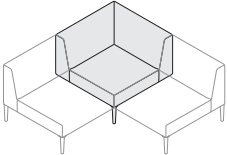
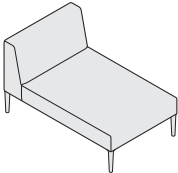
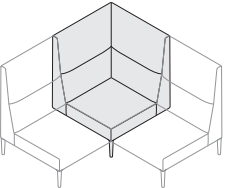
					C.O.M Fabric Upholstery Grades													
	Series	Model	Dimensions	Ydg.	C.O.M	A	B	C	D	E	F	G	H	I	J	K	L	M
 <p>Low-Back Corner</p>	MT	14	28"H x 33.5"D x 33.5"W	3.6	3,028	3,290	3,429	3,568	3,709	3,851	4,009	4,162	4,345	4,585	4,869	5,152	5,432	5,715
 <p>Low-Back Chaise</p>	MT	15	28"H x 48.75"D x 29.75"W	3.3	2,483	2,723	2,852	2,979	3,107	3,238	3,383	3,522	3,691	3,910	4,171	4,430	4,685	4,946
 <p>High-Back Corner</p>	MT	24	44.5"H x 33.5"D x 33.5"W	5.2	4,118	4,496	4,697	4,899	5,100	5,309	5,536	5,756	6,020	6,367	6,776	7,185	7,588	7,998

To Order Follow Steps 1-7

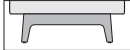
<p>1. Section Type</p> <p>● MT</p> <ul style="list-style-type: none"> 14 Low-Back Corner 15 Low-Back Chaise 24 High-Back Corner 	<p>2. Welt Cord Options</p> <p>● W3 Welt Cord on Seats and Backs +116 (per seat/back)</p> <p>● Welt Cord Options Requires an additional 0.25 yds of fabric. Not available on quilted fabric.</p>	<p>3. Upholstery Options</p> <p>● DF Dual Option</p> <p>The Dual Fabric Option allows for a second fabric to be applied to the seats. When specifying In-Graded fabrics, please apply the higher of the two grades.</p> <table border="0"> <tr> <td>Low-Back Corner</td> <td></td> </tr> <tr> <td>Fabric 1 Seat</td> <td>1.6 yds.</td> </tr> <tr> <td>Fabric 2 Back</td> <td>2.4 yds.</td> </tr> <tr> <td>Low-Back Chaise</td> <td></td> </tr> <tr> <td>Fabric 1 Seats</td> <td>2.4 yds.</td> </tr> <tr> <td>Fabric 2 Backs</td> <td>1.5 yds.</td> </tr> <tr> <td>High-Back Corner</td> <td></td> </tr> <tr> <td>Fabric 1 Seats</td> <td>1.6 yds.</td> </tr> <tr> <td>Fabric 2 Backs</td> <td>4.3 yds.</td> </tr> </table>	Low-Back Corner		Fabric 1 Seat	1.6 yds.	Fabric 2 Back	2.4 yds.	Low-Back Chaise		Fabric 1 Seats	2.4 yds.	Fabric 2 Backs	1.5 yds.	High-Back Corner		Fabric 1 Seats	1.6 yds.	Fabric 2 Backs	4.3 yds.	<p>4. Power Options</p> <p>●</p> <p>Refer to power port ordering steps for seating on page 6.</p>	<p>5. Leg Choice</p> <p>● A Cast Aluminum legs with adjustable glides</p> <p>● W Wood legs with adjustable glides</p> 	<p>6. Leg Finished Choices</p> <p>● AL Cast Aluminum- Polished</p> <p>● Cast Aluminum- Standard Powder Paint</p> <table border="0"> <tr> <td>BL Blue</td> <td>NK Nickel</td> </tr> <tr> <td>BM Black Matte</td> <td>NV Navy</td> </tr> <tr> <td>BR Brass</td> <td>OR Orange</td> </tr> <tr> <td>BT Black Twilight</td> <td>PY Pale Yellow</td> </tr> <tr> <td>CP Champagne</td> <td>RD Red</td> </tr> <tr> <td>DB Dark Bronze</td> <td>RO Red Orange</td> </tr> <tr> <td>DG Dark Gray</td> <td>RR Rusty Red</td> </tr> <tr> <td>DP Dusty Pink</td> <td>SB Soft Blue</td> </tr> <tr> <td>FG Forest Green</td> <td>SD Sand</td> </tr> <tr> <td>LG Light Gray</td> <td>TC Terracotta</td> </tr> <tr> <td>MG Meadow Green</td> <td>TP Taupe</td> </tr> <tr> <td>MK Milk</td> <td>TS Textured Slate</td> </tr> <tr> <td>MS Metallic Silver</td> <td>YL Yellow</td> </tr> </table>	BL Blue	NK Nickel	BM Black Matte	NV Navy	BR Brass	OR Orange	BT Black Twilight	PY Pale Yellow	CP Champagne	RD Red	DB Dark Bronze	RO Red Orange	DG Dark Gray	RR Rusty Red	DP Dusty Pink	SB Soft Blue	FG Forest Green	SD Sand	LG Light Gray	TC Terracotta	MG Meadow Green	TP Taupe	MK Milk	TS Textured Slate	MS Metallic Silver	YL Yellow	<p>7. Textile</p> <p>●</p> <p>Yardages provided are for non-directional fabrics that are applied railroaded. Directional fabrics may require additional yardage. Thick quilted fabrics will be need to be verified and may be handled as a custom order.</p> <p>Refer to Stylex swatch cards and separately published in-graded fabric program to determine grades.</p> <p>See general information section in the main price list for CAL 133 information.</p> <table border="0"> <tr> <td>81 White Oak</td> <td>+606</td> </tr> <tr> <td>83 Natural Maple</td> <td>+546</td> </tr> <tr> <td>85 Walnut</td> <td>+667</td> </tr> </table>	81 White Oak	+606	83 Natural Maple	+546	85 Walnut	+667
Low-Back Corner																																																								
Fabric 1 Seat	1.6 yds.																																																							
Fabric 2 Back	2.4 yds.																																																							
Low-Back Chaise																																																								
Fabric 1 Seats	2.4 yds.																																																							
Fabric 2 Backs	1.5 yds.																																																							
High-Back Corner																																																								
Fabric 1 Seats	1.6 yds.																																																							
Fabric 2 Backs	4.3 yds.																																																							
BL Blue	NK Nickel																																																							
BM Black Matte	NV Navy																																																							
BR Brass	OR Orange																																																							
BT Black Twilight	PY Pale Yellow																																																							
CP Champagne	RD Red																																																							
DB Dark Bronze	RO Red Orange																																																							
DG Dark Gray	RR Rusty Red																																																							
DP Dusty Pink	SB Soft Blue																																																							
FG Forest Green	SD Sand																																																							
LG Light Gray	TC Terracotta																																																							
MG Meadow Green	TP Taupe																																																							
MK Milk	TS Textured Slate																																																							
MS Metallic Silver	YL Yellow																																																							
81 White Oak	+606																																																							
83 Natural Maple	+546																																																							
85 Walnut	+667																																																							

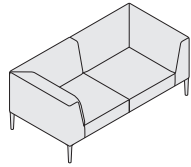

					C.O.M Fabric Upholstery Grades													
	Series	Model	Dimensions	Ydg.	C.O.M	A	B	C	D	E	F	G	H	I	J	K	L	M
Settee Double	MT	32	28"H x 33.75"D x 66.875"W	6.6	5,087	5,567	5,822	6,078	6,335	6,597	6,887	7,165	7,501	7,941	8,461	8,980	9,493	10,013

To Order Follow Steps 1-7

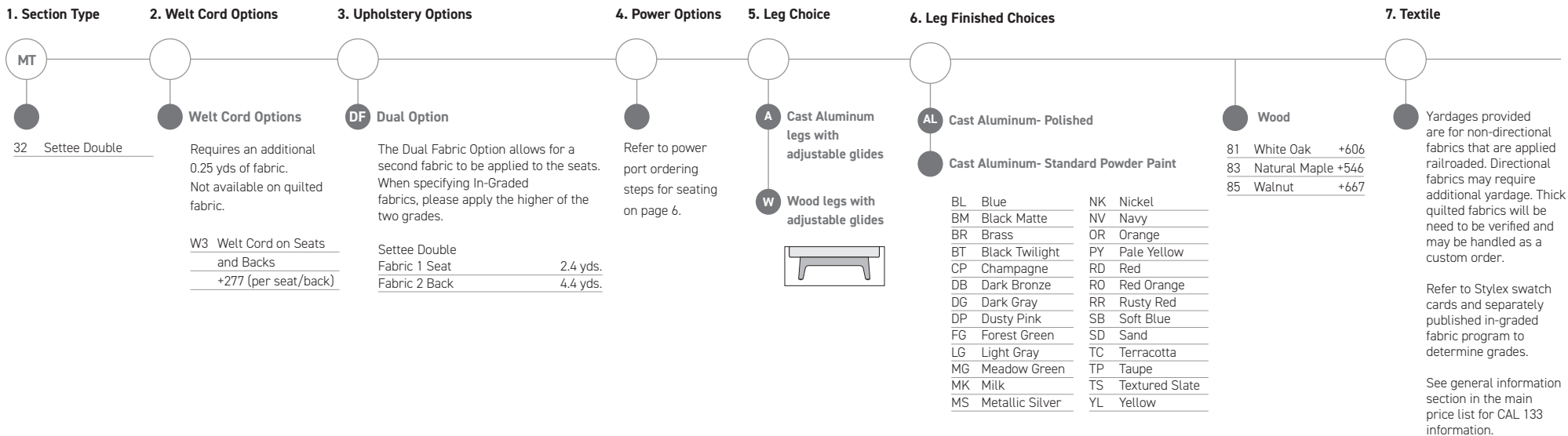

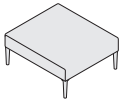
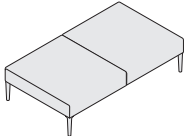
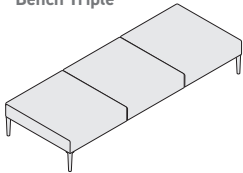
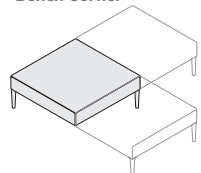

					C.O.M Fabric Upholstery Grades													
	Series	Model	Dimensions	Ydg.	C.O.M	A	B	C	D	E	F	G	H	I	J	K	L	M
Bench Single	MT	01	16"H x 33.75"D x 29.75"W	2.1	1,423	1,576	1,657	1,738	1,821	1,904	1,996	2,085	2,191	2,332	2,497	2,663	2,825	2,990
																		
Bench Double	MT	02	16"H x 33.75"D x 59.5"W	3.0	2,422	2,640	2,756	2,873	2,989	3,109	3,240	3,367	3,520	3,720	3,956	4,193	4,426	4,661
																		
Bench Triple	MT	03	16"H x 33.75"D x 89.25"W	4.1	3,271	3,568	3,726	3,885	4,046	4,208	4,389	4,561	4,770	5,044	5,367	5,690	6,007	6,330
																		
Bench Corner	MT	04	16"H x 33.5"D x 33.5"W	2.2	1,453	1,614	1,698	1,784	1,869	1,957	2,054	2,146	2,258	2,405	2,578	2,751	2,921	3,095
																		

To Order Follow Steps 1-6

<p>1. Section Type</p> <p>MT</p> <ul style="list-style-type: none"> 01 Bench Single 02 Bench Double 03 Bench Triple 04 Bench Corner 	<p>2. Welt Cord Options</p> <p>Requires an additional 0.25 yds of fabric. Not available on quilted fabric.</p> <p>W1 Welt Cord on Seats and Backs +61 (per seat/back)</p>	<p>3. Power Options</p> <p>Refer to power port ordering steps for seating on page 6.</p>	<p>4. Leg Choice</p> <p>A Cast Aluminum legs with adjustable glides</p> <p>W Wood legs with adjustable glides</p> 	<p>5. Leg Finished Choices</p> <p>AL Cast Aluminum- Polished</p> <p>Cast Aluminum- Standard Powder Paint</p> <table border="0"> <tr><td>BL Blue</td><td>NK Nickel</td></tr> <tr><td>BM Black Matte</td><td>NV Navy</td></tr> <tr><td>BR Brass</td><td>OR Orange</td></tr> <tr><td>BT Black Twilight</td><td>PY Pale Yellow</td></tr> <tr><td>CP Champagne</td><td>RD Red</td></tr> <tr><td>DB Dark Bronze</td><td>RO Red Orange</td></tr> <tr><td>DG Dark Gray</td><td>RR Rusty Red</td></tr> <tr><td>DP Dusty Pink</td><td>SB Soft Blue</td></tr> <tr><td>FG Forest Green</td><td>SD Sand</td></tr> <tr><td>LG Light Gray</td><td>TC Terracotta</td></tr> <tr><td>MG Meadow Green</td><td>TP Taupe</td></tr> <tr><td>MK Milk</td><td>TS Textured Slate</td></tr> <tr><td>MS Metallic Silver</td><td>YL Yellow</td></tr> </table>	BL Blue	NK Nickel	BM Black Matte	NV Navy	BR Brass	OR Orange	BT Black Twilight	PY Pale Yellow	CP Champagne	RD Red	DB Dark Bronze	RO Red Orange	DG Dark Gray	RR Rusty Red	DP Dusty Pink	SB Soft Blue	FG Forest Green	SD Sand	LG Light Gray	TC Terracotta	MG Meadow Green	TP Taupe	MK Milk	TS Textured Slate	MS Metallic Silver	YL Yellow	<p>6. Textile</p> <p>Yardages provided are for non-directional fabrics that are applied railroaded. Directional fabrics may require additional yardage. Thick quilted fabrics will be need to be verified and may be handled as a custom order.</p> <p>Refer to Stylex swatch cards and separately published in-graded fabric program to determine grades.</p> <p>See general information section in the main price list for CAL 133 information.</p>
BL Blue	NK Nickel																														
BM Black Matte	NV Navy																														
BR Brass	OR Orange																														
BT Black Twilight	PY Pale Yellow																														
CP Champagne	RD Red																														
DB Dark Bronze	RO Red Orange																														
DG Dark Gray	RR Rusty Red																														
DP Dusty Pink	SB Soft Blue																														
FG Forest Green	SD Sand																														
LG Light Gray	TC Terracotta																														
MG Meadow Green	TP Taupe																														
MK Milk	TS Textured Slate																														
MS Metallic Silver	YL Yellow																														

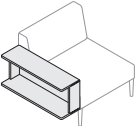
Wood	
81 White Oak	+775
83 Natural Maple	+667
85 Walnut	+873

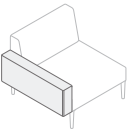
					C.O.M Fabric Upholstery Grades													
	Series	Model	Dimensions	Ydg.	C.O.M	A	B	C	D	E	F	G	H	I	J	K	L	M
	MT	41	13.5"H x 33.25"D x 9.125"W	0.6	606	649	673	695	719	742	769	795	824	864	912	960	1,007	1,054
	MT	42	14"H x 33"D x 10"W	-	White Oak	2,180	Natural Maple	2,422	Walnut	2,907								
	MT	43	12"H x 33.5"D x 2"W	1.4	363	487	552	618	685	753	826	899	984	1,098	1,233	1,366	1,498	1,631
	MT	44	13"H x 33.75"D x 5.75"W	1.5	448	558	615	674	732	793	857	921	998	1,097	1,215	1,334	1,450	1,568

To Order Follow Steps 1-5

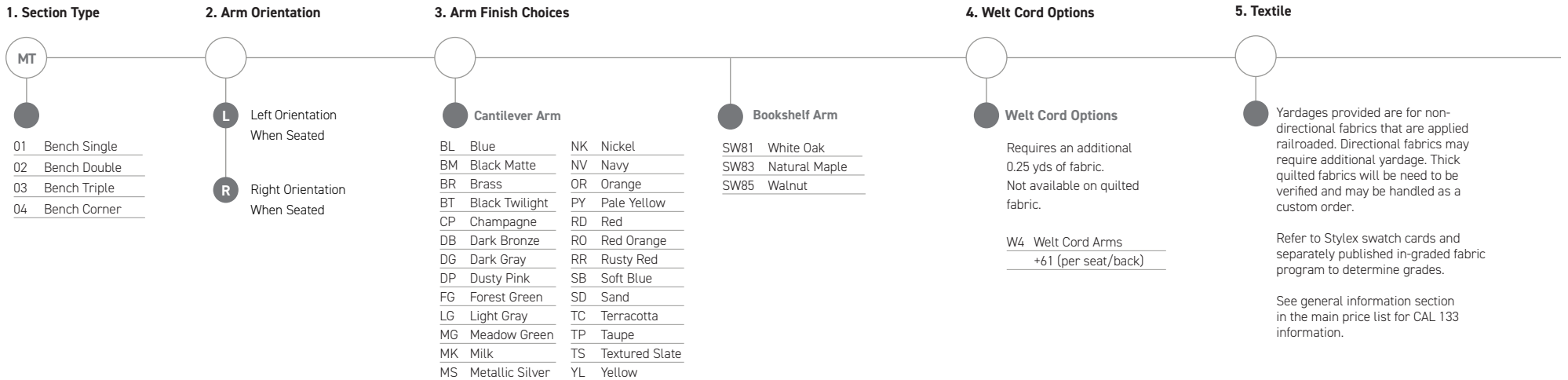

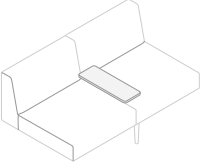
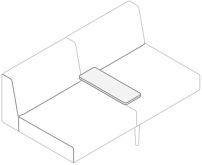
					C.O.M Fabric Upholstery Grades															
	Series	Model	Dimensions	Ydg.	C.O.M	A	B	C	D	E	F	G	H	I	J	K	L	M		
	Mid Arm Wood	MT	45	3"H x 22"D x 7.5"W	3.6	White Oak	939													
						Natural Maple	969													
						Walnut	1,090													
	Mid Arm Upholstery	MT	46	4.25"H x 22.5"D x 8"W	3.3	606	686	728	771	814	857	905	952	1,008	1,082	1,168	1,255	1,340	1,427	

To Order Follow Steps 1-3

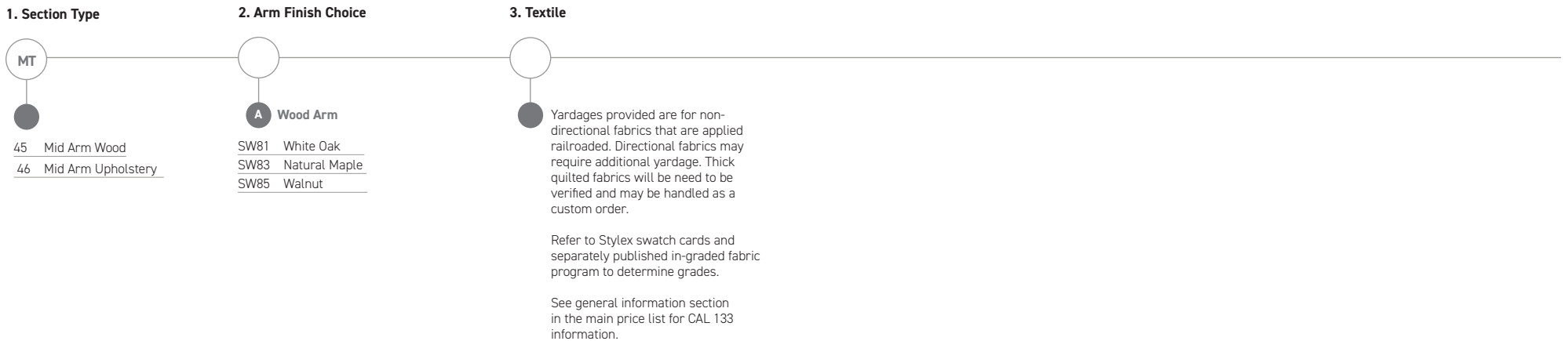
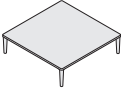
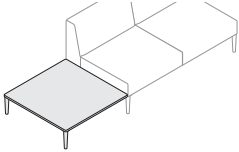
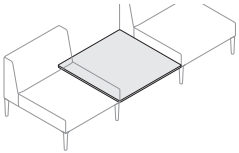
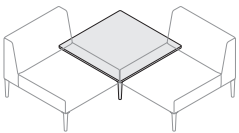

				Table Material Selection								
	Series	Model	Dimensions	CS Caesarstone			SS Solid Surface			SW Solid Wood		
	MT	51	9.25-9.5"H x 33.5"D x 33.5"W	51	Jet Black	4,603	01	Arctic White	2,422	81	White Oak	1,587
				52	Sleek Concrete	4,603	03	Ivory White	2,422	83	Natural Maple	1,429
				65	Pure White	5,936	04	Grey	3,089	85	Walnut	2,156
				96	Statuario Nuvo	7,510	05	Steel Grey	4,118			
							06	Black	3,634			
	MT	52	9.25-9.5"H x 33.5"D x 33.5"W	51	Jet Black	4,481	01	Arctic White	2,301	81	White Oak	1,466
				52	Sleek Concrete	4,481	03	Ivory White	2,301	83	Natural Maple	1,307
				65	Pure White	5,814	04	Grey	2,968	85	Walnut	2,035
				96	Statuario Nuvo	7,389	05	Steel Grey	3,997			
							06	Black	3,512			
	MT	53	9.25-9.5"H x 33.5"D x 33.5"W	51	Jet Black	4,481	01	Arctic White	2,301	81	White Oak	1,466
				52	Sleek Concrete	4,481	03	Ivory White	2,301	83	Natural Maple	1,307
				65	Pure White	5,814	04	Grey	2,968	85	Walnut	2,035
				96	Statuario Nuvo	7,389	05	Steel Grey	3,997			
							06	Black	3,512			
	MT	54	9.25-9.5"H x 33.5"D x 33.5"W	51	Jet Black	4,603	01	Arctic White	2,422	81	White Oak	1,587
				52	Sleek Concrete	4,603	03	Ivory White	2,422	83	Natural Maple	1,429
				65	Pure White	5,936	04	Grey	3,089	85	Walnut	2,156
				96	Statuario Nuvo	7,510	05	Steel Grey	4,118			
							06	Black	3,634			

To Order Follow Steps 1-5

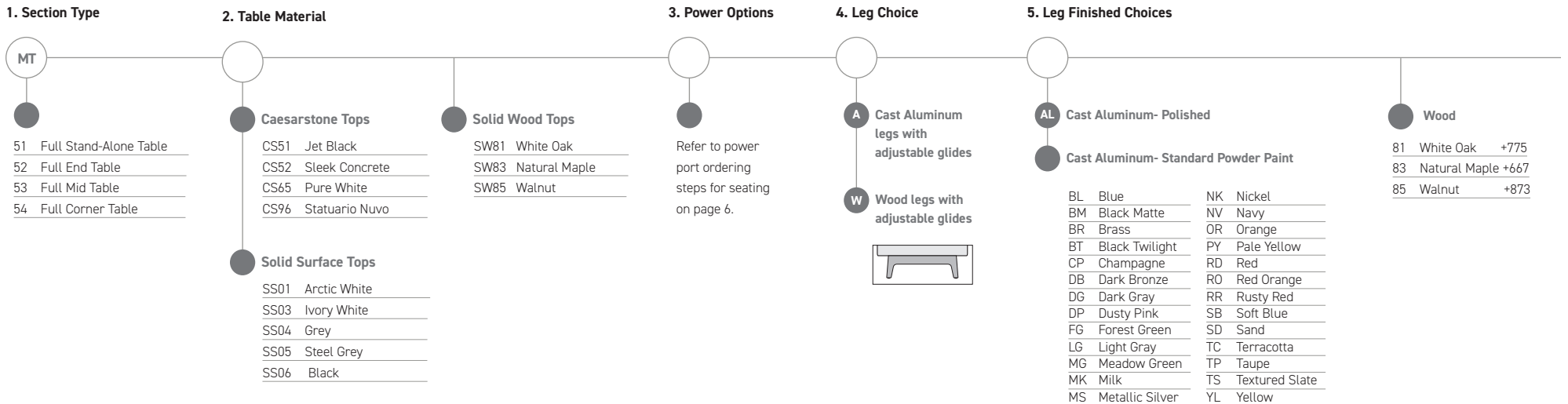
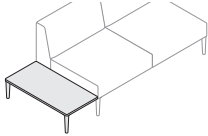
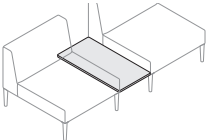
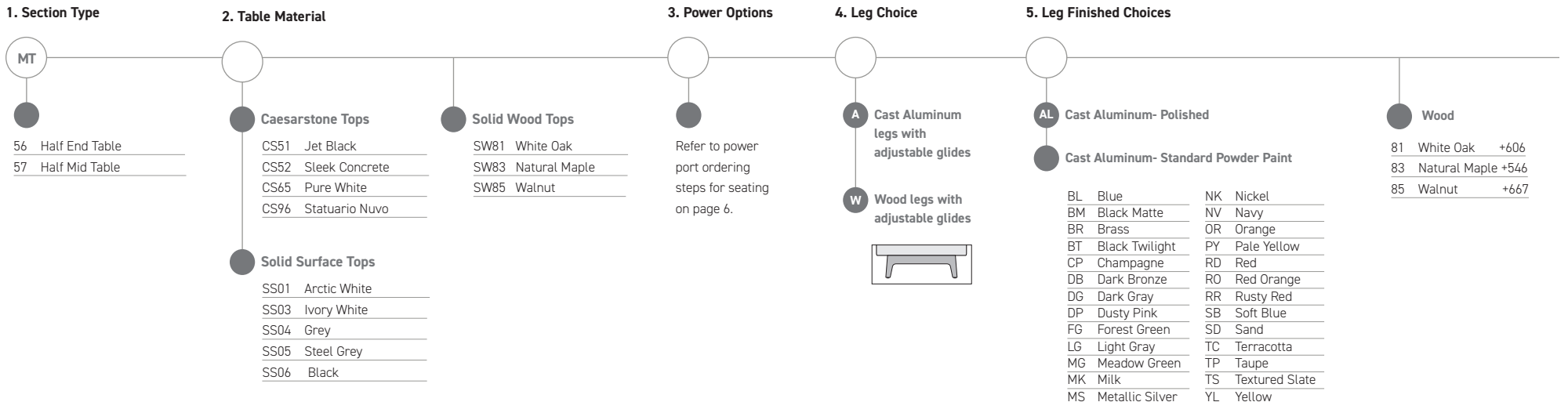

				Table Material Selection								
	Series	Model	Dimensions	CS Caesarstone			SS Solid Surface			SW Solid Wood		
Half End Table 	MT	56	9.25-9.5"H x 33.5"D x 20"W	51	Jet Black	4,301	01	Arctic White	1,878	81	White Oak	1,066
				52	Sleek Concrete	4,301	03	Ivory White	1,878	83	Natural Maple	969
				65	Pure White	4,907	04	Grey	2,362	85	Walnut	1,442
				96	Statuario Nuvo	4,966	05	Steel Grey	3,271			
							06	Black	2,968			
Half Mid Table 	MT	57	9.25-9.5"H x 33.5"D x 20"W	51	Jet Black	4,301	01	Arctic White	1,878	81	White Oak	1,066
				52	Sleek Concrete	4,301	03	Ivory White	1,878	83	Natural Maple	969
				65	Pure White	4,907	04	Grey	2,362	85	Walnut	1,442
				96	Statuario Nuvo	4,966	05	Steel Grey	3,271			
							06	Black	2,968			

To Order Follow Steps 1-5



stylex

Nestle

PRICE LIST

Effective November 01, 2023

General Information

GENERAL INFORMATION

Terms

Net 30 days from date of invoice.
FOB Delanco, NJ

Damaged Shipments

All Stylex products are carefully inspected before they are packed in sturdy cartons designed to satisfy shipping requirements. Stylex is not responsible for damage in shipment. The transportation company assumes responsibility for delivering products to you in good condition when the bill of lading is signed. You protect yourself by refusing shipments showing damage or shortage until transportation company has noted on the delivery sheet the extent of damage or shortage. Concealed damage should be reported to the carrier as soon as discovered, but not later than 15 days after receiving shipment.

Return/Restocking Policy

Return shipments will not be accepted unless specifically authorized by Stylex in writing. The Return Authorization number should be clearly marked on the carton. The customer returning Stylex products is responsible for return shipping costs. Merchandise must be returned unused. Returned merchandise is subject to a 35% restocking fee.

Specials/Customs

Modifications to standard products will be considered for large runs. Contact Stylex for more information.

Design Changes

In keeping with modern manufacturing advances, Stylex reserves the right to incorporate minor modifications and design changes in products without notice.

Cancellation Policy

No charge prior to production except for inventory specifically requisitioned to fulfill the particular order. After production has begun, only actual costs incurred, including labor and material, will be billed to the customer.

WARRANTY

Except as provided below, Stylex warrants exclusively to the original Purchaser of our product that all parts, under normal use and service, will be free from defects in workmanship and material for a period of ten (10) years from the date of purchase. "Normal use and service" means that the product will be used in a typical office environment for 40-45 hours per week.

This warranty is subject to the following limitations, exclusions and provisions:

Wood components of plywood stacking chairs
(such as Brooks and Welcome)
5 years

Upholstery
(including mesh used for Click, F4, Insight, and Zephyr Mesh)
3 years

SAVA Mesh
10 years

COM Upholstery
No warranty
Stylex makes every effort to ensure that the COM Upholstery it approves is suitable for the intended use. Nevertheless, we will not warrant, and assume no responsibility for, the durability or tailoring quality of any COM or COL. If you have any concerns about the ultimate appearance of any covering, please order an upholstered sample.

Painted Stack Chair Frames
No Warranty
We will not warrant the finish of painted stack chair frames against damage from stacking. We recommend ordering chrome frames for chairs that will be stacked.

Felt Glides
No warranty
Due to the different surfaces on which felt glides may be used, we cannot warrant their durability over time.

If this product fails during normal use and service within the applicable warranty period (other than through normal wear and tear), please send a description of the relevant part and the nature of the defect, together with proof of purchase of the product, to Stylex at: Customer Service. c/o Stylex, P.O. Box 5038, Delanco, NJ 08075. PLEASE DO NOT RETURN PARTS OR THE PRODUCT TO STYLEX UNLESS INSTRUCTED TO DO SO BY STYLEX. Stylex will, at its option, either repair or replace the product or the part found defective by Stylex completely without charge for materials or labor. Purchaser may be required (at the option of Stylex) to return to Stylex at Purchaser's expense any defective part with all freight or shipping charges prepaid. The foregoing warranty shall be void if the product has been altered or repaired (other than by Stylex). The warranty does not cover damage to the product caused by accident, neglect, misuse, abuse, modification to the product by anyone other than Stylex or damage caused by use of the product for a purpose other than that for which it was designed. This warranty extends only to the original Purchaser of the product.

No Other Warranties

This warranty is in lieu of all other warranties, expressed or implied, including, but not limited to, implied warranties of merchantability and fitness for a particular purpose. The rights and remedies provided herein are the exclusive rights and remedies of the original purchaser of the product.

No Liability For Damages

In no event shall Stylex or its suppliers be responsible or liable for any special, indirect, consequential, or incidental damages. In no event shall the liability of Stylex exceed the actual purchase price paid to Stylex for the product.

Out of Warranty Products

For all products no longer covered by our warranty, please refer to our Design for Durability and Upgradability Policy. Contact Customer Service if you would like to purchase any replaceable components to further extend the life of any Stylex seating product. This warranty applies to all Stylex products purchased on April 13, 2018, and thereafter.

PRODUCT TAKE BACK PROGRAM

At Stylex, responsible stewardship of our products extends beyond their initial use. Our Product Take Back Program provides a practical solution for the end of our products' intended life cycle.

Through our partnership with ANEW, a 501(c)(3) nonprofit organization, we offer clients a comprehensive take-back solution for surplus office furniture and materials, regardless of their condition. ANEW's mission aligns with ours—to connect surplus resources with non-profits, public agencies, and underserved communities, minimizing landfill impact and maximizing corporate social responsibility.

By repurposing surplus items, we strengthen community networks and reduce environmental impact. Stylex proudly supports ANEW, integrating this partnership into our strategic sales strategy since 2014. Learn more at www.anewfound.org.

Initiate a Product Take Back through ANEW by emailing Stylex at info@stylexdesign.com. For additional end-of-life recovery options, refer to our Product Disassembly Instructions and End of Life Recovery Options documents, available in the Resources section of each product on our website. Together, let's build a sustainable future.

FREIGHT PROGRAM

Stylex offers a Guaranteed Freight Program, which provides the purchaser the ability to determine shipping and handling charges at the time of order. Freight charges will be calculated as a percentage of the net product price and added to the invoice at the time of shipment. The continental United States has been divided into three zones. Please use the map below to determine the freight charges for the product's destination. There is a minimum freight charge of \$150.

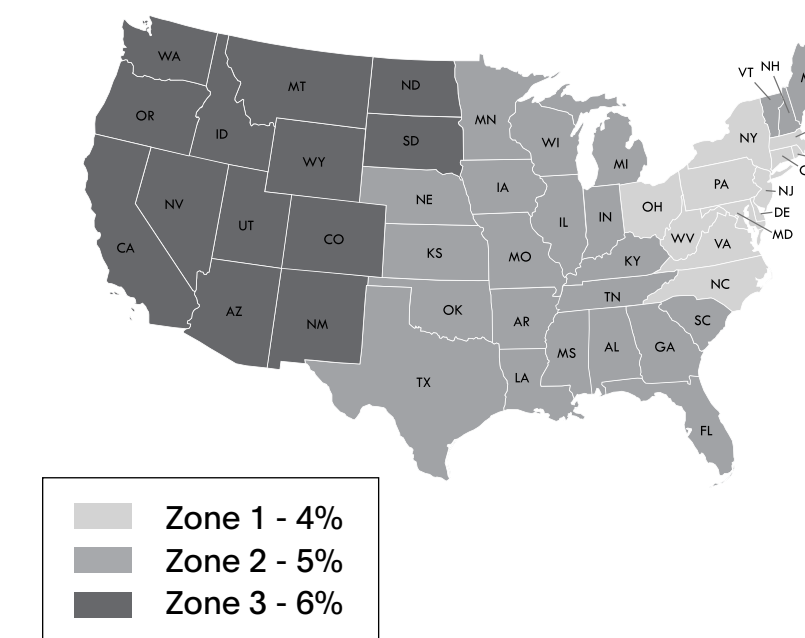

ZONE 1 - 4%

Connecticut
Delaware
New York
New Jersey
Maryland
Massachusetts
North Carolina
Ohio
Pennsylvania
Rhode Island
Virginia
Washington D.C.
West Virginia

ZONE 2 - 5%

Alabama
Arkansas
Canada, Ontario
Canada, Quebec
Florida
Georgia
Iowa
Illinois
Indiana
Kansas
Kentucky
Louisiana
Nebraska
New Hampshire
Oklahoma
Maine
Michigan
Minnesota
Mississippi
South Carolina
Tennessee
Texas
Vermont
Wisconsin

ZONE 3 - 6%

Arizona
California
Colorado
Idaho
Montana
Nevada
New Mexico
North Dakota
Oregon
South Dakota
Utah
Washington
Wyoming

Quote Per Project

Alaska
Hawaii
Canada
(outside Ontario & Quebec)
Mexico

General Information

TEXTILE PARTNERS & APPROVALS

Textile Partners

To customize your furniture performance needs and design vision, Stylex offers a wide selection of in-graded leathers and textiles from Grades A through Y. We've partnered with leading manufacturers on the options, focusing on color, price, durability, and construction. To view our partners and explore our digital carded program with broadly approved textiles, visit [this page](#). We stand by these textiles: They're tried and tested, and will effortlessly fit into any design aesthetic.

Textile Approvals

To view Stylex Approved Textile documents to determine specific product approval status, refer to our Product Tested Textiles documents, available in the Resources section of each product on our website.

CAL 117 AND 133 COMPLIANCE

CAL 117-2013

All Stylex seating satisfies the requirements of CAL 117-2013 so long as one of our standard or in-graded textiles is applied. COM textiles cannot be so guaranteed. Please contact the supplier of COM's directly to determine the fire retardancy of any COM supplied to us.

CAL 133

Most Stylex seating can be ordered to meet the requirements of CAL 133. When ordering, simply specify "CAL 133 compliance required". The upcharge for this option is \$54 list per yard. Please refer to the COM yardage of each model to determine the number of yards required. We do frequently require full-scale burn tests in order to certify CAL 133 before an order will be accepted. Such burn tests may increase normal lead times and do carry additional charges. Please contact customer service for details.

CUSTOMER'S OWN MATERIAL/LEATHER

Customer's own material (COM) and customer's own leather (COL) will generally be upholstered at the price designated in each product's price list. Please be advised, however, that we specifically reserve the right to charge a higher price when we determine that special circumstances, such as unusual repeats or challenging materials, present themselves. All orders for custom coverings must be approved by Stylex before they will be accepted for production. To submit proposed textile for approval, please use the COM form [here](#).

Special Note:

We assume no responsibility for the durability or tailoring quality of any COM or COL. Directional covers in particular may not meet your satisfaction due to the design of certain products. Please be advised that COM and COL orders are not subject to return. If you have doubts about the ultimate appearance of certain coverings, please order a sample done with that specific COM or COL. In addition, while we inspect textiles for mill imperfections, some are difficult to recognize. We cannot be responsible for defects, color inaccuracies, dye lot variations, or other flaws.

Under no circumstances will we be responsible for COM shortages, flaws, or other such problems. Finally, it is not our responsibility to police the receipt of COM's in order to meet delivery deadlines, and we assume our customers are aware of any undue delay in the shipment of their COM textiles.

COM textile and COL leather should be sent prepaid to: Stylex

**Attn: COM/COL - [Your PO #]
740 Coopertown Road
Delanco, NJ 08075**

Clearly mark textile or leather with the dealer's name, purchase order number, and furniture model number of the item to be covered. Actual furniture orders should include the same information, as well as a description of the textile or leather, including pattern and color number, in order to provide a cross reference.

Yardage requirements shown in the price list are based on non-directional goods of 54" width. Textiles less than 54" wide or those requiring matching (stripes, prints, or large patterned designs) call for additional yardage. We will be happy to supply yardage requirements for large quantities where economies may be realized.

Add the following yardage for stripes, plaids, or patterns with repeats:

Textile Width	Plain Textile	2-14" Repeat	15-24" Repeat	25-27" Repeat	28-36" Repeat
54"	0%	10%	15%	20%	25%
50"	10%	20%	25%	30%	35%
48"	15%	25%	30%	35%	40%
45"	40%	50%	55%	60%	65%
36"	50%	60%	65%	70%	75%

COM/COL FORM

To avoid delay in processing COM orders we request that you submit a sample of your COM textile stapled to this form which can be downloaded [here](#). If a textile has a stripe or design, the size of the repeat should be indicated. Please indicate the textile supplier's name, textile number, and color. Also indicate the Stylex product on which the textile will be used.

The textile supplier must indicate on his shipping labels the dealer name and purchase order number as well as the Stylex model number.

Please Note:

No order may be entered into production or have a shipping date assigned until all related COM is received at the factory.



CENTER OF STRIPE OR DESIGN

TOP	TOP
-----	-----

1. Size of Repeat

2. Textile Supplier

3. Textile Number

4. Color

5. Stylex Product

Contents

<hr/>	
COLORS, MATERIALS, AND FINISHES	5
<hr/>	
STATEMENT OF LINE	6
<hr/>	
DIMENSIONS	7
<hr/>	
HOW TO ORDER	8
<hr/>	
PRICING	9
<hr/>	

CLICK THE TITLES ABOVE TO NAVIGATE THROUGH THE DOCUMENT
PRODUCT HEADERS ON SUBSEQUENT PAGES LINK BACK TO THIS PAGE

Nestle

COLORS, MATERIALS, AND FINISHES

POWDER COAT FINISH

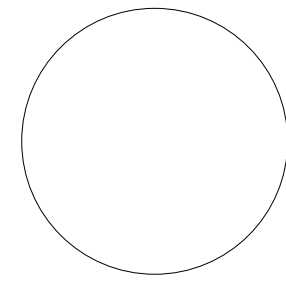

MILK
(MK)

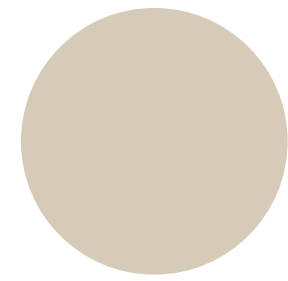

SAND
(SD)

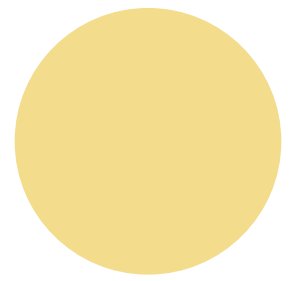

PALE YELLOW
(PY)

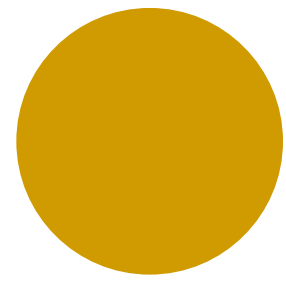

YELLOW
(YL)

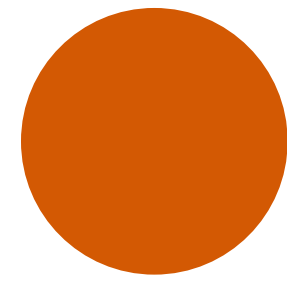

ORANGE
(OR)

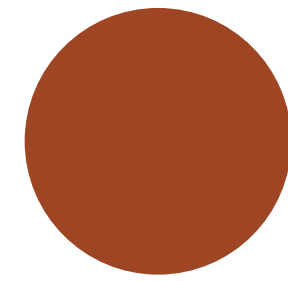

TERRACOTTA
(TC)

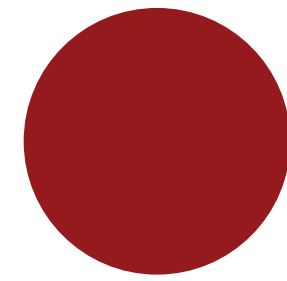

RED
(RD)

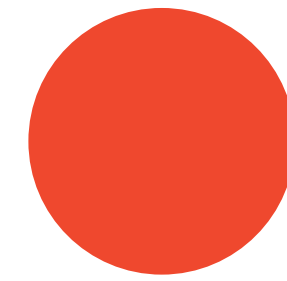

RED ORANGE
(RO)

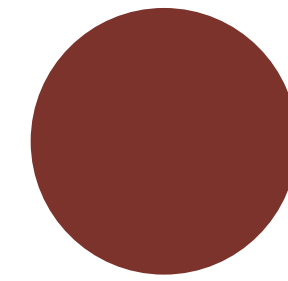

RUSTY RED
(RR)

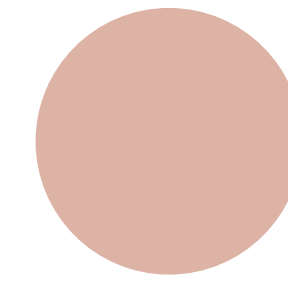

DUSTY PINK
(DP)

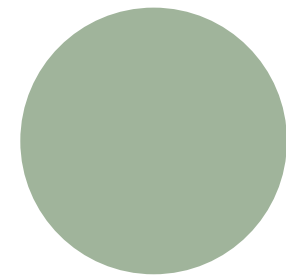

MEADOW GREEN
(MG)

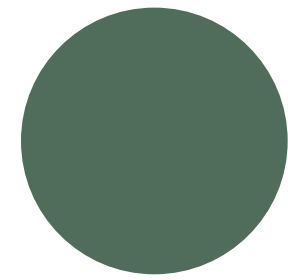

FOREST GREEN
(FG)

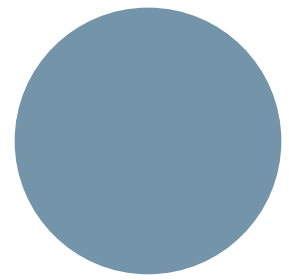

SOFT BLUE
(SB)

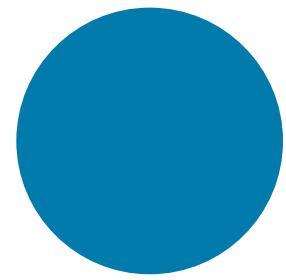

BLUE
(BL)

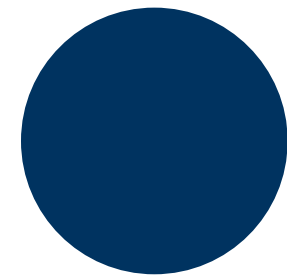

NAVY
(NV)

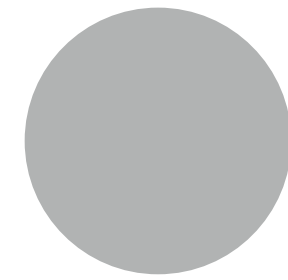

LIGHT GRAY
(LG)

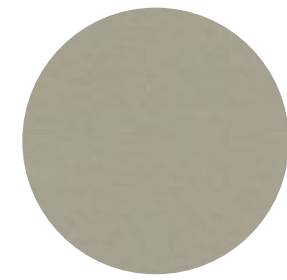

CHAMPAGNE
(CP)

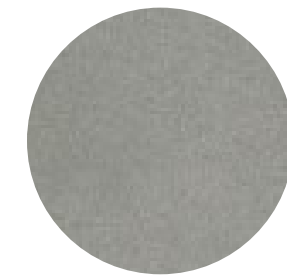

METALLIC SILVER
(MS)

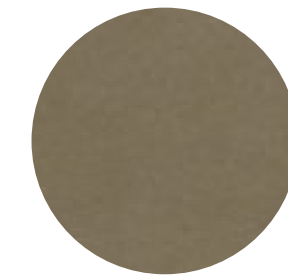

NICKEL
(NK)

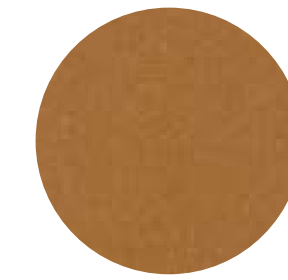

BRASS
(BR)

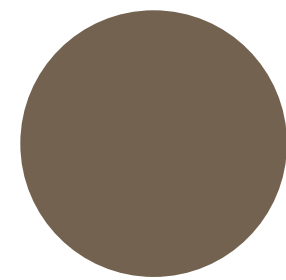

TAUPE
(TP)

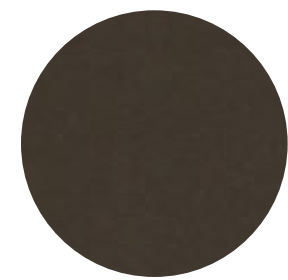

DARK BRONZE
(DB)

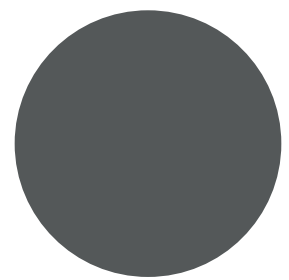

DARK GRAY
(DG)



TEXTURED SLATE
(TS)

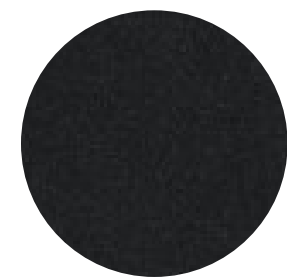

BLACK TWILIGHT
(BT)

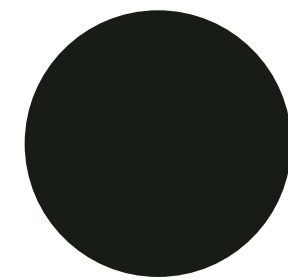

BLACK MATTE
(BM)

METAL FINISH

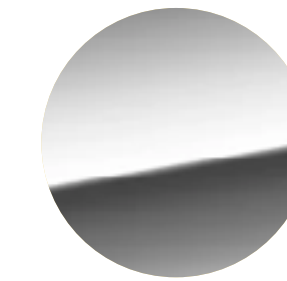

CHROME
(CH)

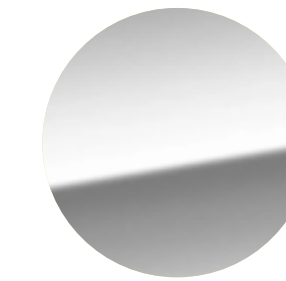

POLISHED
ALUMINUM
(AL)

WOOD LEG FINISH



MAPLE
(83)



WHITE OAK
(81)

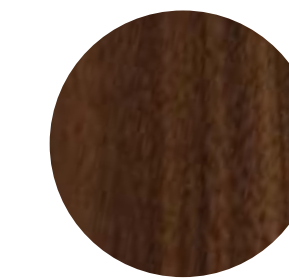

WALNUT
(85)

Nestle

SPECIFICATION GUIDE: STATEMENT OF LINE & DIMENSIONS

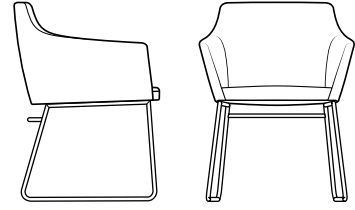
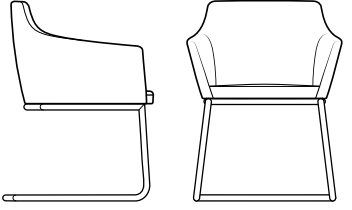
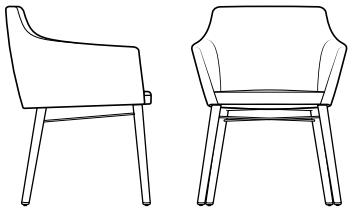
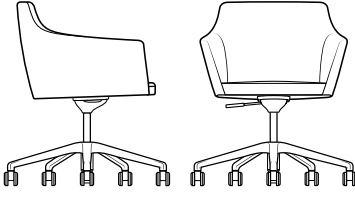
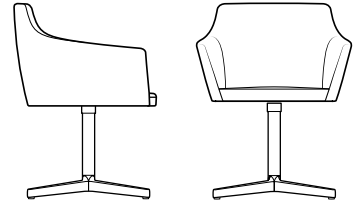
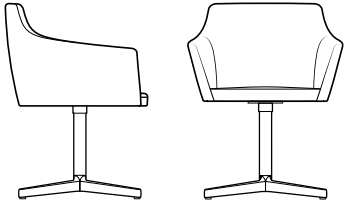
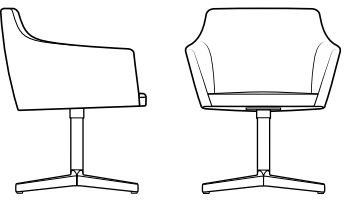
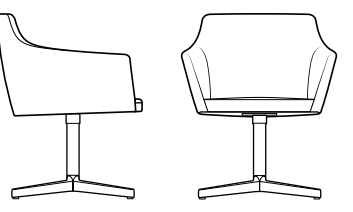
OVERVIEW	GUEST			LOUNGE		ADJUSTABLE HEIGHT	
	Mitered Sled 	Cantilever Sled 	Wood Metal Leg 			Five Blade 	
	Swivel Cast Aluminum 	Swivel Return Cast Aluminum 		Swivel Cast Aluminum 	Swivel Return Cast Aluminum 		

PRODUCT INFORMATION

Design

Brad Ascalon

Bases

Sled bases utilize steel tubing. Both 4-blade and 5-blade bases are cast aluminum. Wood Legs are braced with a steel cross-structure beneath the seat. The wood legs are produced from either White Oak, Maple, or Walnut.

All sled base components, as well as the steel cross-structure on 4-leg wood bases, may be ordered in bright chrome, or one of our powder coat finishes. The 4-blade and 5-blade swivel bases are polished aluminum or powder coated.

Glides

Glides are either plastic or plastic with felt pads. Please note that felt pad glides are not available on models with Aluminum or Cantilever bases.

Performance Standards

Manufactured to comply with:

- ANSI/BIFMA X5.1 General-Purpose Office Chairs - Tests

Environment

Greenguard Certified

Nestle

SPECIFICATION GUIDE: STATEMENT OF LINE & DIMENSIONS

DIMENSIONS

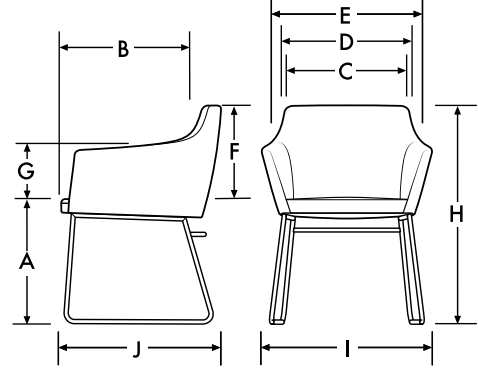
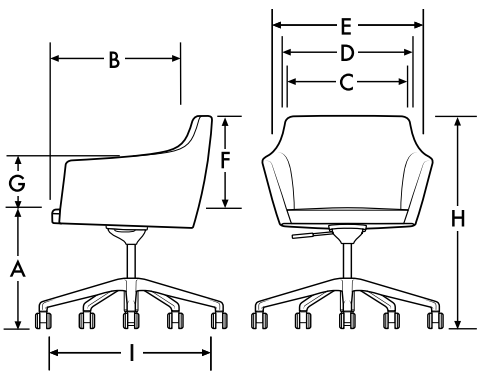
	Mitered Sled Guest	Cantilever Sled Guest	Wood Metal Leg Guest	Swivel Cast Aluminum, Guest	Swivel Return Cast Aluminum Guest	Swivel Cast Aluminum Lounge	Swivel Return Cast Aluminum Lounge
<p>A. Seat Height</p> <p>B. Seat Depth</p> <p>C. Seat Width</p> <p>D. Back Width</p> <p>E. Distance Between Arms</p> <p>F. Back Height</p> <p>G. Arm Height</p> <p>H. Overall Height</p> <p>I. Overall Width</p> <p>J. Overall Depth</p> 	<p>A. 18</p> <p>B. 19.5</p> <p>C. 18</p> <p>D. 19.25</p> <p>E. 22.75</p> <p>F. 14</p> <p>G. 8</p> <p>H. 33</p> <p>I. 25.75</p> <p>J. 23.75</p>	<p>A. 18"</p> <p>B. 19.5"</p> <p>C. 18"</p> <p>D. 19.25"</p> <p>E. 22.75"</p> <p>F. 14"</p> <p>G. 8"</p> <p>H. 33"</p> <p>I. 25.75"</p> <p>J. 25"</p>	<p>A. 18</p> <p>B. 19.5</p> <p>C. 18</p> <p>D. 19.25</p> <p>E. 22.75</p> <p>F. 14</p> <p>G. 8</p> <p>H. 32.75</p> <p>I. 25.75</p> <p>J. 24.25"</p>	<p>A. 18</p> <p>B. 19.5</p> <p>C. 18</p> <p>D. 19.25</p> <p>E. 22.75</p> <p>F. 14</p> <p>G. 8</p> <p>H. 32.5</p> <p>I. 25.75</p> <p>J. 24.25"</p>	<p>A. 18</p> <p>B. 19.5</p> <p>C. 18</p> <p>D. 19.25</p> <p>E. 22.75</p> <p>F. 14</p> <p>G. 8</p> <p>H. 32.5</p> <p>I. 25.75</p> <p>J. 24.25"</p>	<p>A. 16.5"</p> <p>B. 19.5"</p> <p>C. 18"</p> <p>D. 19.25"</p> <p>E. 22.75"</p> <p>F. 14"</p> <p>G. 8"</p> <p>H. 30"</p> <p>I. 25.75"</p> <p>J. 24.25"</p>	<p>A. 16.5"</p> <p>B. 19.5"</p> <p>C. 18"</p> <p>D. 19.25"</p> <p>E. 22.75"</p> <p>F. 14"</p> <p>G. 8"</p> <p>H. 30"</p> <p>I. 25.75"</p> <p>J. 24.25"</p>
<p>A. Seat Height</p> <p>B. Seat Depth</p> <p>C. Seat Width</p> <p>D. Back Width</p> <p>E. Distance Between Arms</p> <p>F. Back Height</p> <p>G. Arm Height</p> <p>H. Overall Height</p> <p>I. Overall Depth Chair</p> 	<p>Five Blade Cast Aluminum</p> <p>A. 15.4" - 20.4"</p> <p>B. 19.5"</p> <p>C. 18"</p> <p>D. 19.25"</p> <p>E. 22.75"</p> <p>F. 14"</p> <p>G. 8"</p> <p>H. 28.5" - 33.5"</p> <p>I. 24.25"</p>						

Nestle

SPECIFICATION GUIDE: HOW TO ORDER

MODEL CODE BREAKDOWN

Sample Model Code: NS2162CTPGBMCOM

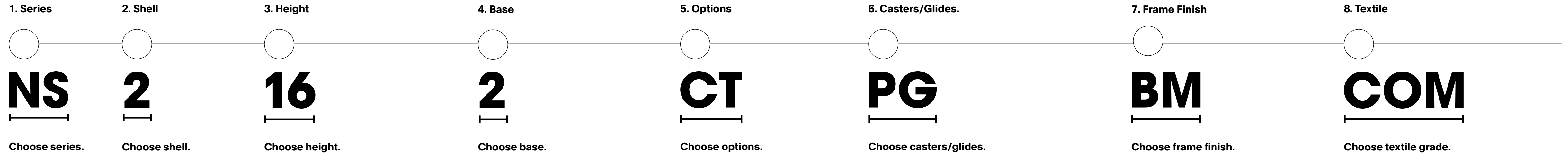

Series
NS – NESTLE

Shell Type
2 – UPHOLSTERED

Height Options
16 – LOUNGE HEIGHT
18 – GUEST HEIGHT
40 – ADJUSTABLE HEIGHT SWIVEL

Base Opitons
2 – MITERED SLED
3 – CANTILEVER SLED
5 – WOOD METAL LEG
7 – SWIVEL CAST ALUMINUM
8 – SWIVEL RETURN CAST ALUMINUM
9 – FIVE-BLADE ALUMINUM BASE

Options
DF1 – DUAL UPHOLSTERY
CT – CONTRASTING THREAD

Glides
PG – PLASTIC GLIDES
FG – PLASTIC GLIDES WITH FELT PADS
AG – ADJUSTABLE GLIDES

Black Casters
BS – BLACK TRIM SOFT WHEEL
CC – CHROME TRIM CASTERS
CS – CHROME TRIM SOFT WHEEL

Gray Casters
GC – GRAY CARPET CASTERS

Frame Color
Standard Powder Coat
BL – BLUE
BM – BLACK MATTE
BR – BRASS
BT – BLACK TWILIGHT
CP – CHAMPAGNE
DB – DARK BRONZE
DG – DARK GRAY
DP – DUSTY PINK
FG – FOREST GREEN
LG – LIGHT GRAY
MG – MEADOW GREEN
MK – MILK
MS – METALLIC SILVER
NK – NICKEL
NV – NAVY
OR – ORANGE
PY – PALE YELLOW
RD – RED
RO – RED ORANGE
RR – RUSTY RED
SB – SOFT BLUE
SD – SAND
TC – TERRACOTTA
TP – TAUPE
TS – TEXTURED SLATE
YL – YELLOW

Other
CH – CHROME

Wood Finish
81 – WHITE OAK
83 – NATURAL MAPLE
85 – WALNUT
09 – CUSTOM COLOR MATCH

Textile
Textile Grades
COM – CUSTOMER'S OWN MATERIAL
A – GRADE A
B – GRADE B
C – GRADE C
D – GRADE D
E – GRADE E
F – GRADE F
G – GRADE G
H – GRADE H
I – GRADE I
J – GRADE J
K – GRADE K
L – GRADE L
M – GRADE M

Leather Grades
COL – CUSTOMER'S OWN LEATHER
W – GRADE W
X – GRADE X
Y – GRADE Y
E1 – GRADE E1
E2 – GRADE E2

Nestle

PRICING

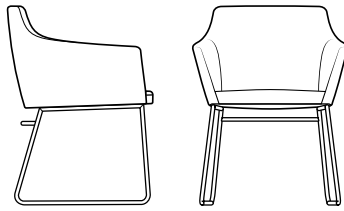
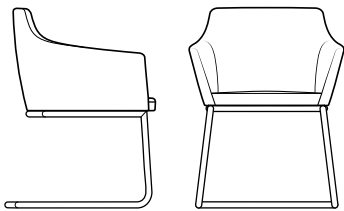
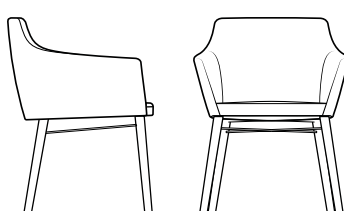
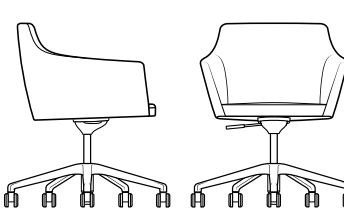
TITLE	SERIES	SEAT	FRAME	DIMENSIONS	COM	COL	Textile Upholstery Grades										Leather Upholstery Grades							
							YDG	SQFT	COM	A	B	C	D	E	F	G	H	I	W	X	Y	E1	E2	
Mitered Sled Frame 	NS	218	2	25.75W x 23.75D x 33H	2.25	30	1,647	1,825	1,924	2,018	2,114	2,211	2,318	2,424	2,552	2,712	2,354	2,532	3,116	3,382	3,991			
Cantilever Sled Frame 	NS	218	3	25.75W x 25D x 33H	2.25	30	1,647	1,825	1,924	2,018	2,114	2,211	2,318	2,424	2,552	2,712	2,354	2,532	3,116	3,382	3,991			
Wood Metal Leg Frame 	NS	218	5	25.75W x 24.25D x 32.75H	2.25	30	1,933	2,112	2,208	2,306	2,400	2,498	2,605	2,710	2,835	2,999	2,642	2,818	3,416	3,669	4,290			
Five-Blade Aluminum Base 	NS	240	9	25.75W x 24.25D x 28.5 - 33.5H	2.25	30	1,933	2,112	2,208	2,306	2,400	2,498	2,605	2,710	2,835	2,999	2,642	2,818	3,416	3,669	4,290			

To Order Select Below

<p>1. Series</p> <p>Series</p> <p>NS NESTLE</p>	<p>2. Shell</p> <p>Shell</p> <p>2 UPHOLSTERED</p>	<p>3. Height</p> <p>Height</p> <p>18 GUEST HEIGHT</p> <p>ADJUSTABLE HEIGHT SWIVEL</p> <p>40</p>	<p>4. Base</p> <p>Base</p> <p>2 MITERED SLED</p> <p>3 CANTILEVER SLED</p> <p>5 WOOD METAL LEG</p> <p>FIVE-BLADE ALUMINUM BASE</p> <p>9</p> <p>Cylinder color will match the frame if the frame finish is black matte, light gray, or milk. Otherwise, the cylinder will be chrome.</p>	<p>5. Options</p> <p>Options</p> <p>DF1 DUAL UPHOLSTERY</p> <p>CONTRASTING THREAD</p> <p>CT</p> <p>Dual Upholstery: Back Shell Upholstery 1.7 yds 25 sqft</p> <p>Seat Upholstery 0.75 yds 10 sqft</p>	<p>6. Casters/Glides</p> <p>Glides</p> <p>PG PLASTIC GLIDES</p> <p>PLASTIC GLIDES WITH FELT PADS</p> <p>FG</p> <p>Casters</p> <p>BS BLACK TRIM SOFT WHEEL CASTER +43</p> <p>CHROME TRIM CARPET CASTER +98</p> <p>CC CHROME TRIM SOFT WHEEL CASTER +124</p> <p>GC GRAY CARPET CASTER +28</p> <p>GS GRAY TRIM SOFT WHEEL CASTER +53</p> <p>9</p> <p>Only casters available on five-blade base. Black carpet casters are used on five blade base unless other caster option is chosen.</p>	<p>5. Frame Finish</p> <p>Powder Coat</p> <p>BL BLUE</p> <p>BM BLACK MATTE</p> <p>BR BRASS</p> <p>BT BLACK TWILIGHT</p> <p>CP CHAMPAGNE</p> <p>DB DARK BRONZE</p> <p>DG DARK GRAY</p> <p>DP DUSTY PINK</p> <p>FG FOREST GREEN</p> <p>Other</p> <p>CH CHROME +147</p> <p>AL POLISHED ALUMINUM</p> <p>Chrome available for non-bladed bases. Polished aluminum available for bladed bases.</p>	<p>7. Upholstery</p> <p>See general information section for details on textile program and COM/COL information.</p> <p>Wood</p> <p>81 WHITE OAK</p> <p>83 NATURAL MAPLE</p> <p>85 WALNUT +129</p> <p>09 CUSTOM COLOR MATCH</p> <p>There is a 20 chair minimum for custom wood color match.</p>
--	--	--	---	---	--	---	---

Nestle

PRICING

TITLE	SERIES	SEAT	FRAME	DIMENSIONS	COM	COL	Textile Upholstery Grades											Leather Upholstery Grades						
							YDG	SQFT	COM	A	B	C	D	E	F	G	H	I	W	X	Y	E1	E2	
Swivel Cast Aluminum Base, Guest Height	NS	218	7	25.75W x 24.25D x 32.5H	2.25	30	1,718	1,897	1,993	2,092	2,186	2,284	2,391	2,496	2,621	2,784	2,426	2,604	3,190	3,453	4,067			
Swivel Cast Aluminum Base, Lounge Height	NS	216	7	25.75W x 24.25D x 32.5H	2.25	30	1,718	1,897	1,993	2,092	2,186	2,284	2,391	2,496	2,621	2,784	2,426	2,604	3,190	3,453	4,067			
Swivel Return Cast Aluminum Base, Guest Height	NS	218	8	25.75W x 24.25D x 32.5H	2.25	30	1,898	2,075	2,172	2,268	2,365	2,463	2,568	2,676	2,801	2,963	2,605	2,783	3,379	3,632	4,253			
Swivel Return Cast Aluminum Base, Lounge Height	NS	216	8	25.75W x 24.25D x 32.5H	2.25	30	1,898	2,075	2,172	2,268	2,365	2,463	2,568	2,676	2,801	2,963	2,605	2,783	3,379	3,632	4,253			

To Order Select Below

<p>1. Series</p> <p>Series</p> <p>NS NESTLE</p>	<p>2. Shell</p> <p>Shell</p> <p>2 UPHOLSTERED</p>	<p>3. Height</p> <p>Height</p> <p>16 LOUNGE HEIGHT 18 GUEST HEIGHT</p>	<p>4. Base</p> <p>Base</p> <p>7 SWIVEL CAST ALUMINUM 8 SWIVEL RETURN CAST ALUMINUM</p>	<p>5. Options</p> <p>Options</p> <p>DF1 DUAL UPHOLSTERY AG ADJUSTABLE GLIDES +14 CT CONTRASTING THREAD</p> <p>Dual Upholstery: Back Shell Upholstery 1.7 yds 25 sqft</p> <p>Seat Upholstery 0.75 yds 10 sqft</p>	<p>6. Frame Finish</p> <p>Powder Coat</p> <p>BL BLUE BM BLACK MATTE BR BRASS BT BLACK TWILIGHT CP CHAMPAGNE DB DARK BRONZE DG DARK GRAY DP DUSTY PINK FG FOREST GREEN</p> <p>Other</p> <p>AL POLISHED ALUMINUM</p>	<p>7. Upholstery</p> <p>See general information section for details on textile program and COM/COL information.</p> <p>LG LIGHT GRAY MG MEADOW GREEN MK MILK MS METALLIC SILVER NV NAVY OR ORANGE PY PALE YELLOW RD RED</p> <p>RO RED ORANGE RR RUSTY RED SB SOFT BLUE SD SAND TC TERRACOTTA TP TAUPE TS TEXTURED SLATE YL YELLOW</p>
--	--	---	---	---	---	--

stylex

NYC

PRICE LIST

Effective November 01, 2023

General Information

GENERAL INFORMATION

Terms

Net 30 days from date of invoice.
FOB Delanco, NJ

Damaged Shipments

All Stylex products are carefully inspected before they are packed in sturdy cartons designed to satisfy shipping requirements. Stylex is not responsible for damage in shipment. The transportation company assumes responsibility for delivering products to you in good condition when the bill of lading is signed. You protect yourself by refusing shipments showing damage or shortage until transportation company has noted on the delivery sheet the extent of damage or shortage. Concealed damage should be reported to the carrier as soon as discovered, but not later than 15 days after receiving shipment.

Return/Restocking Policy

Return shipments will not be accepted unless specifically authorized by Stylex in writing. The Return Authorization number should be clearly marked on the carton. The customer returning Stylex products is responsible for return shipping costs. Merchandise must be returned unused. Returned merchandise is subject to a 35% restocking fee.

Specials/Customs

Modifications to standard products will be considered for large runs. Contact Stylex for more information.

Design Changes

In keeping with modern manufacturing advances, Stylex reserves the right to incorporate minor modifications and design changes in products without notice.

Cancellation Policy

No charge prior to production except for inventory specifically requisitioned to fulfill the particular order. After production has begun, only actual costs incurred, including labor and material, will be billed to the customer.

WARRANTY

Except as provided below, Stylex warrants exclusively to the original Purchaser of our product that all parts, under normal use and service, will be free from defects in workmanship and material for a period of ten (10) years from the date of purchase. "Normal use and service" means that the product will be used in a typical office environment for 40-45 hours per week.

This warranty is subject to the following limitations, exclusions and provisions:

Wood components of plywood stacking chairs
(such as Brooks and Welcome)
5 years

Upholstery
(including mesh used for Click, F4, Insight, and Zephyr Mesh)
3 years

SAVA Mesh
10 years

COM Upholstery
No warranty
Stylex makes every effort to ensure that the COM Upholstery it approves is suitable for the intended use. Nevertheless, we will not warrant, and assume no responsibility for, the durability or tailoring quality of any COM or COL. If you have any concerns about the ultimate appearance of any covering, please order an upholstered sample.

Painted Stack Chair Frames
No Warranty
We will not warrant the finish of painted stack chair frames against damage from stacking. We recommend ordering chrome frames for chairs that will be stacked.

Felt Glides
No warranty
Due to the different surfaces on which felt glides may be used, we cannot warrant their durability over time.

If this product fails during normal use and service within the applicable warranty period (other than through normal wear and tear), please send a description of the relevant part and the nature of the defect, together with proof of purchase of the product, to Stylex at: Customer Service. c/o Stylex, P.O. Box 5038, Delanco, NJ 08075. PLEASE DO NOT RETURN PARTS OR THE PRODUCT TO STYLEX UNLESS INSTRUCTED TO DO SO BY STYLEX. Stylex will, at its option, either repair or replace the product or the part found defective by Stylex completely without charge for materials or labor. Purchaser may be required (at the option of Stylex) to return to Stylex at Purchaser's expense any defective part with all freight or shipping charges prepaid. The foregoing warranty shall be void if the product has been altered or repaired (other than by Stylex). The warranty does not cover damage to the product caused by accident, neglect, misuse, abuse, modification to the product by anyone other than Stylex or damage caused by use of the product for a purpose other than that for which it was designed. This warranty extends only to the original Purchaser of the product.

No Other Warranties

This warranty is in lieu of all other warranties, expressed or implied, including, but not limited to, implied warranties of merchantability and fitness for a particular purpose. The rights and remedies provided herein are the exclusive rights and remedies of the original purchaser of the product.

No Liability For Damages

In no event shall Stylex or its suppliers be responsible or liable for any special, indirect, consequential, or incidental damages. In no event shall the liability of Stylex exceed the actual purchase price paid to Stylex for the product.

Out of Warranty Products

For all products no longer covered by our warranty, please refer to our Design for Durability and Upgradability Policy. Contact Customer Service if you would like to purchase any replaceable components to further extend the life of any Stylex seating product. This warranty applies to all Stylex products purchased on April 13, 2018, and thereafter.

PRODUCT TAKE BACK PROGRAM

At Stylex, responsible stewardship of our products extends beyond their initial use. Our Product Take Back Program provides a practical solution for the end of our products' intended life cycle.

Through our partnership with ANEW, a 501(c)(3) nonprofit organization, we offer clients a comprehensive take-back solution for surplus office furniture and materials, regardless of their condition. ANEW's mission aligns with ours—to connect surplus resources with non-profits, public agencies, and underserved communities, minimizing landfill impact and maximizing corporate social responsibility.

By repurposing surplus items, we strengthen community networks and reduce environmental impact. Stylex proudly supports ANEW, integrating this partnership into our strategic sales strategy since 2014. Learn more at www.anewfound.org.

Initiate a Product Take Back through ANEW by emailing Stylex at info@stylexdesign.com. For additional end-of-life recovery options, refer to our Product Disassembly Instructions and End of Life Recovery Options documents, available in the Resources section of each product on our website. Together, let's build a sustainable future.

FREIGHT PROGRAM

Stylex offers a Guaranteed Freight Program, which provides the purchaser the ability to determine shipping and handling charges at the time of order. Freight charges will be calculated as a percentage of the net product price and added to the invoice at the time of shipment. The continental United States has been divided into three zones. Please use the map below to determine the freight charges for the product's destination. There is a minimum freight charge of \$150.

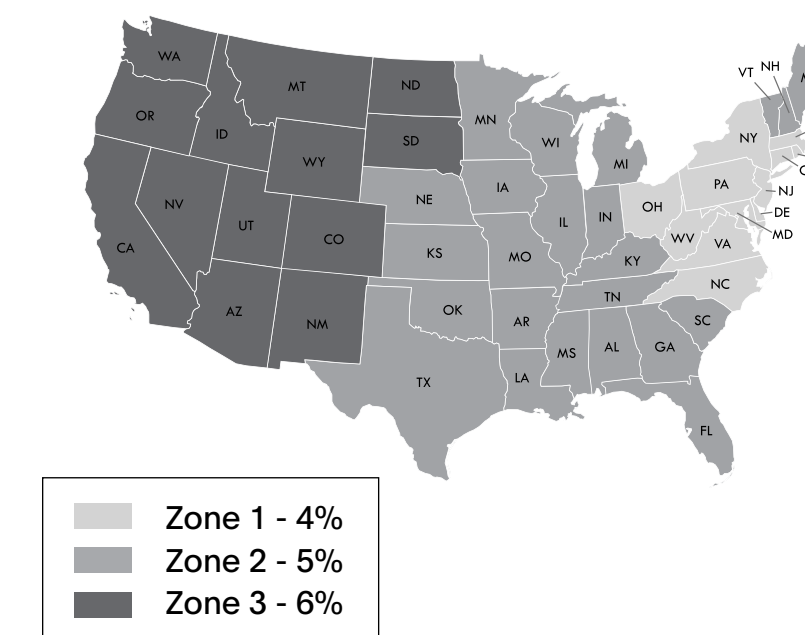

ZONE 1 - 4%

Connecticut
Delaware
New York
New Jersey
Maryland
Massachusetts
North Carolina
Ohio
Pennsylvania
Rhode Island
Virginia
Washington D.C.
West Virginia

ZONE 2 - 5%

Alabama
Arkansas
Canada, Ontario
Canada, Quebec
Florida
Georgia
Iowa
Illinois
Indiana
Kansas
Kentucky
Louisiana
Nebraska
New Hampshire
Oklahoma
Maine
Michigan
Minnesota
Missouri
Mississippi
South Carolina
Tennessee
Texas
Vermont
Wisconsin

ZONE 3 - 6%

Arizona
California
Colorado
Idaho
Montana
Nevada
New Mexico
North Dakota
Oregon
South Dakota
Utah
Washington
Wyoming

Quote Per Project

Alaska
Hawaii
Canada
(outside Ontario & Quebec)
Mexico

General Information

TEXTILE PARTNERS & APPROVALS

Textile Partners

To customize your furniture performance needs and design vision, Stylex offers a wide selection of in-graded leathers and textiles from Grades A through Y. We've partnered with leading manufacturers on the options, focusing on color, price, durability, and construction. To view our partners and explore our digital carded program with broadly approved textiles, visit [this page](#). We stand by these textiles: They're tried and tested, and will effortlessly fit into any design aesthetic.

Textile Approvals

To view Stylex Approved Textile documents to determine specific product approval status, refer to our Product Tested Textiles documents, available in the Resources section of each product on our website.

CAL 117 AND 133 COMPLIANCE

CAL 117-2013

All Stylex seating satisfies the requirements of CAL 117-2013 so long as one of our standard or in-graded textiles is applied. COM textiles cannot be so guaranteed. Please contact the supplier of COM's directly to determine the fire retardancy of any COM supplied to us.

CAL 133

Most Stylex seating can be ordered to meet the requirements of CAL 133. When ordering, simply specify "CAL 133 compliance required". The upcharge for this option is \$54 list per yard. Please refer to the COM yardage of each model to determine the number of yards required. We do frequently require full-scale burn tests in order to certify CAL 133 before an order will be accepted. Such burn tests may increase normal lead times and do carry additional charges. Please contact customer service for details.

CUSTOMER'S OWN MATERIAL/LEATHER

Customer's own material (COM) and customer's own leather (COL) will generally be upholstered at the price designated in each product's price list. Please be advised, however, that we specifically reserve the right to charge a higher price when we determine that special circumstances, such as unusual repeats or challenging materials, present themselves. All orders for custom coverings must be approved by Stylex before they will be accepted for production. To submit proposed textile for approval, please use the COM form [here](#).

Special Note:

We assume no responsibility for the durability or tailoring quality of any COM or COL. Directional covers in particular may not meet your satisfaction due to the design of certain products. Please be advised that COM and COL orders are not subject to return. If you have doubts about the ultimate appearance of certain coverings, please order a sample done with that specific COM or COL. In addition, while we inspect textiles for mill imperfections, some are difficult to recognize. We cannot be responsible for defects, color inaccuracies, dye lot variations, or other flaws.

Under no circumstances will we be responsible for COM shortages, flaws, or other such problems. Finally, it is not our responsibility to police the receipt of COM's in order to meet delivery deadlines, and we assume our customers are aware of any undue delay in the shipment of their COM textiles.

COM textile and COL leather should be sent prepaid to: Stylex

**Attn: COM/COL - [Your PO #]
740 Coopertown Road
Delanco, NJ 08075**

Clearly mark textile or leather with the dealer's name, purchase order number, and furniture model number of the item to be covered. Actual furniture orders should include the same information, as well as a description of the textile or leather, including pattern and color number, in order to provide a cross reference.

Yardage requirements shown in the price list are based on non-directional goods of 54" width. Textiles less than 54" wide or those requiring matching (stripes, prints, or large patterned designs) call for additional yardage. We will be happy to supply yardage requirements for large quantities where economies may be realized.

Add the following yardage for stripes, plaids, or patterns with repeats:

Textile Width	Plain Textile	2-14" Repeat	15-24" Repeat	25-27" Repeat	28-36" Repeat
54"	0%	10%	15%	20%	25%
50"	10%	20%	25%	30%	35%
48"	15%	25%	30%	35%	40%
45"	40%	50%	55%	60%	65%
36"	50%	60%	65%	70%	75%

COM/COL FORM

To avoid delay in processing COM orders we request that you submit a sample of your COM textile stapled to this form which can be downloaded [here](#). If a textile has a stripe or design, the size of the repeat should be indicated. Please indicate the textile supplier's name, textile number, and color. Also indicate the Stylex product on which the textile will be used.

The textile supplier must indicate on his shipping labels the dealer name and purchase order number as well as the Stylex model number.

Please Note:

No order may be entered into production or have a shipping date assigned until all related COM is received at the factory.



CENTER OF STRIPE OR DESIGN

TOP	TOP
-----	-----

1. Size of Repeat

2. Textile Supplier

3. Textile Number

4. Color

5. Stylex Product

Contents

<hr/>		<hr/>	
COLORS, MATERIALS, AND FINISHES	5	STANDARD	15
<hr/>		<hr/>	
STATEMENT OF LINE	6	WRAP-OVER	22
<hr/>		<hr/>	
OPTIONS AND POWER	7	RELAXED	29
<hr/>		<hr/>	
DIMENSIONS	8	LOOSE	36
<hr/>		<hr/>	
IDEA STARTERS AND ORDERING GUIDE	11	ARMS, TABLES, AND PILLOWS	53
<hr/>		<hr/>	
HOW TO ORDER	12		
<hr/>			

CLICK THE TITLES ABOVE TO NAVIGATE THROUGH THE DOCUMENT
PRODUCT HEADERS ON SUBSEQUENT PAGES LINK BACK TO THIS PAGE

NYC

COLORS, MATERIALS, AND FINISHES

POWDER COATED PAINTED METAL

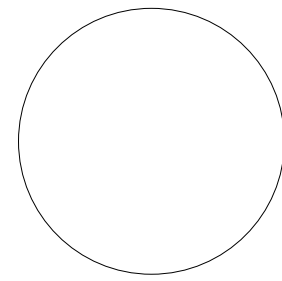

MILK
(MK)

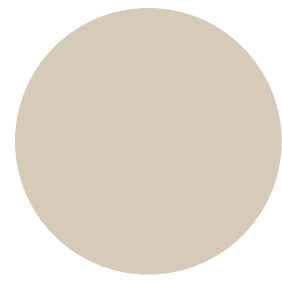

SAND
(SD)

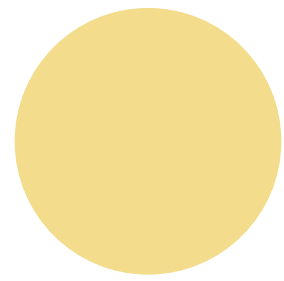

PALE YELLOW
(PY)

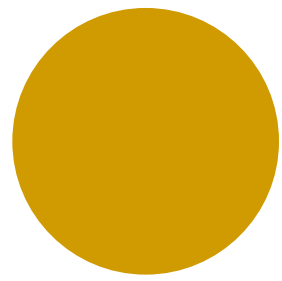

YELLOW
(YL)

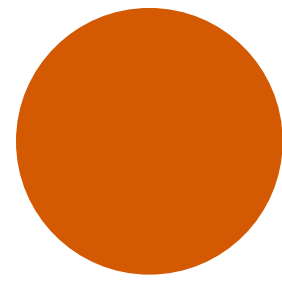

ORANGE
(OR)

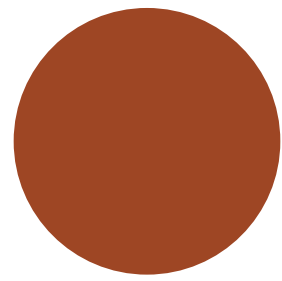

TERRACOTTA
(TC)

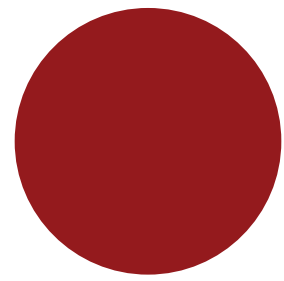

RED
(RD)

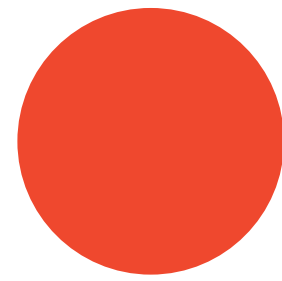

RED ORANGE
(RO)

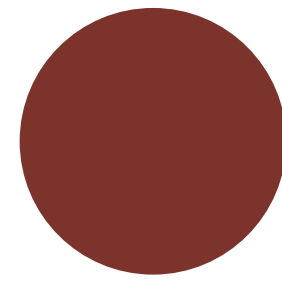

RUSTY RED
(RR)

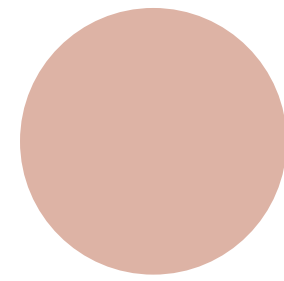

DUSTY PINK
(DP)

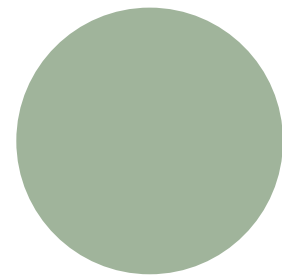

MEADOW GREEN
(MG)

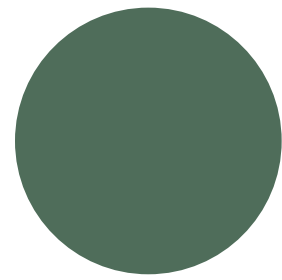

FOREST GREEN
(FG)

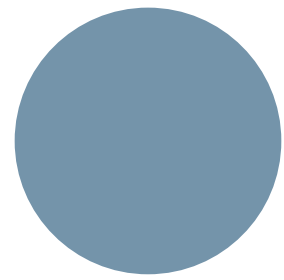

SOFT BLUE
(SB)

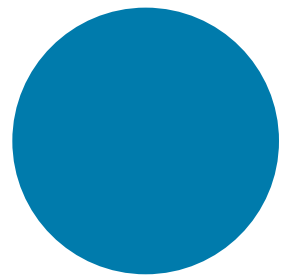

BLUE
(BL)

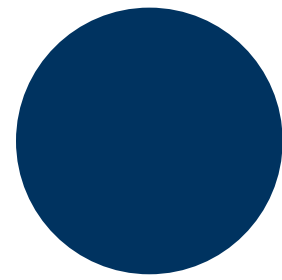

NAVY
(NV)

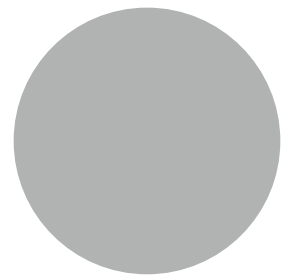

LIGHT GRAY
(LG)



CHAMPAGNE
(CP)

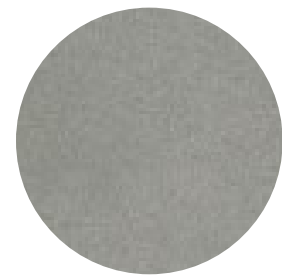

METALLIC SILVER
(MS)

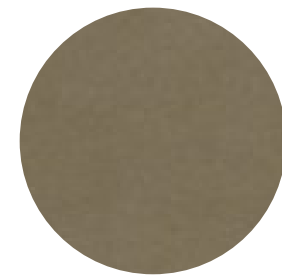

NICKEL
(NK)

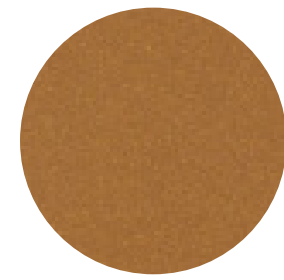

BRASS
(BR)

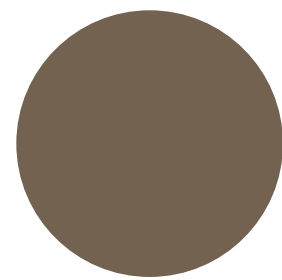

TAUPE
(TP)



DARK BRONZE
(DB)

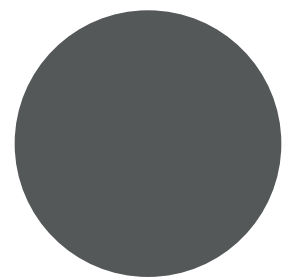

DARK GRAY
(DG)



TEXTURED SLATE
(TS)

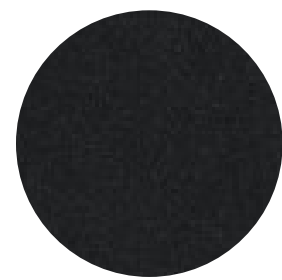

BLACK TWILIGHT
(BT)

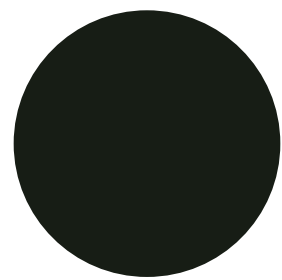

BLACK MATTE
(BM)

POLISHED METAL

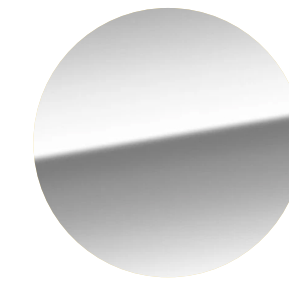

POLISHED
ALUMINUM
(AL)

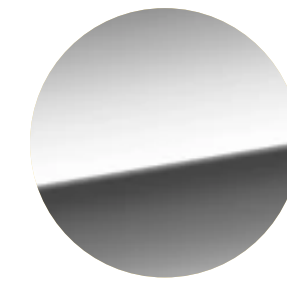

CHROME
(CH)

CAESARSTONE®

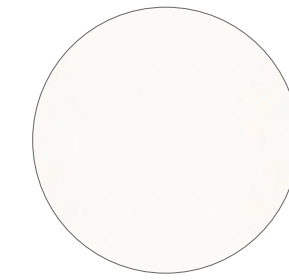

PURE
WHITE
(65)



STATUARIO
NUVO
(96)

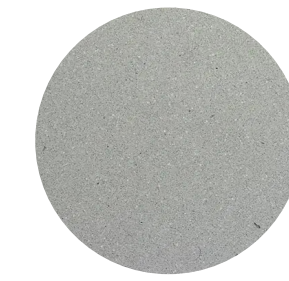



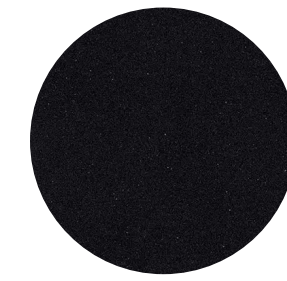



SLEEK
CONCRETE
(52)

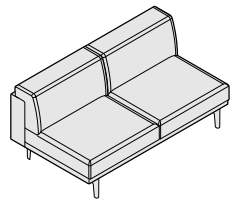
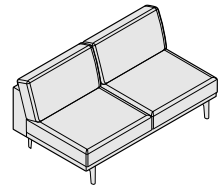

JET BLACK
(51)

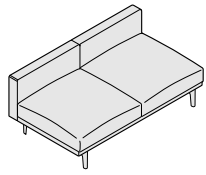
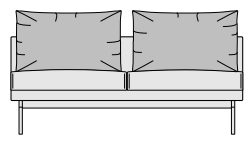
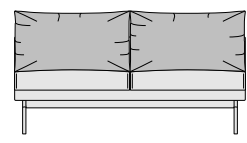
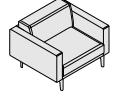
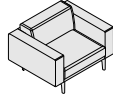
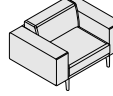
NYC

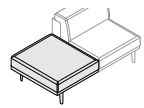
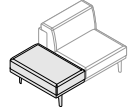
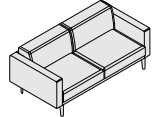
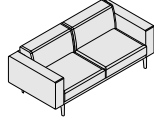
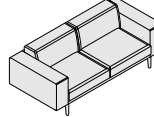
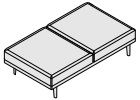
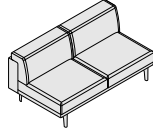
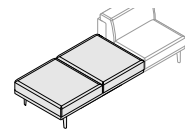
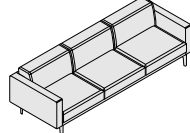
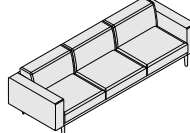
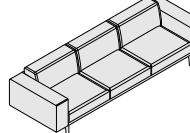
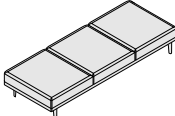
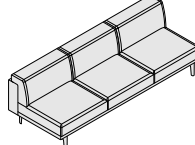
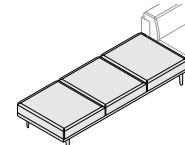
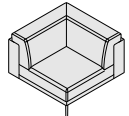
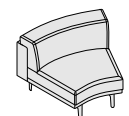
SPECIFICATION GUIDE: STATEMENT OF LINE

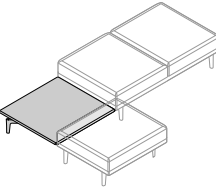
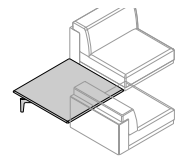
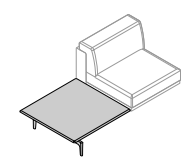
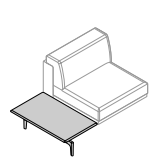
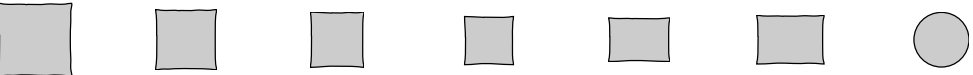
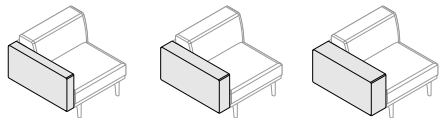
STYLES							
<p>NYC is offered in the following 6 styles. All styles can be applied to the seat, corner, and bench components listed below.</p>	Wrap-Over	Standard	Relaxed	Loose No Cushions	Loose Partial Cushions	Loose Full Cushions	
							
OVERVIEW	STAND ALONE				MODULAR		
One-Seat	Club Chair 4" Arms 	Club Chair 6" Arms 	Club Chair 9" Arms 	Bench 	Modular Unit 	In-line Bench 	In-line 2/3 Bench 
Two-Seat	Sofa 4" Arms 	Sofa 6" Arms 	Sofa 9" Arms 	Bench 	Modular Unit 	In-line Bench 	
Three-Seat	Sofa 4" Arms 	Sofa 6" Arms 	Sofa 9" Arms 	Bench 	Modular Unit 	In-line Bench 	
Corner					90° Unit 	135° Unit 	150° Unit 
Table	Bench Corner Table (used with stand alone bench models only) 				Inline Corner Table 	Inline Full Table 	Inline 2/3 Table 
Accessories	Throw Pillow 24×24, 20×20, 18×18, 16×16, 14×20, 16×22, 18" Round 				Modular Arms 4, 6, or 9" 		

PRODUCT INFORMATION

Design

Stylex

Throw Pillow Construction

Throw pillows incorporate down/feather inserts.

Understructure

NYC support frames consist of aluminum legs attached to steel rails. These frames may be powder coated in a variety of finishes, or ordered as polished aluminum with chrome-plated rails. Adjustable glides are standard.

Tables

Caesarstone is available, but surfaces may also be specified and purchased by the customer for installation on site. In either case, the top is supported by a steel plate with four holes. Stylex will supply digital templates for all table styles, or you may request a physical template from Stylex Customer Service.

Testing

Manufactured to comply with:

- ANSI/BIFMA X5.4 Public and Lounge Seating Standard

Environment

Greenguard Certified.

NYC

SPECIFICATION GUIDE: OPTIONS AND POWER

OPTIONS

Upholstery

Contrasting Thread

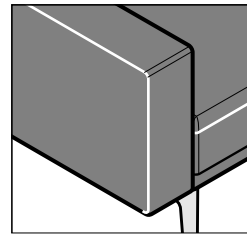

Dual Upholstery

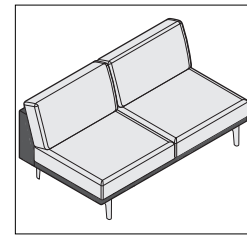

Welt Cord*



Sewn and Button Tuft*

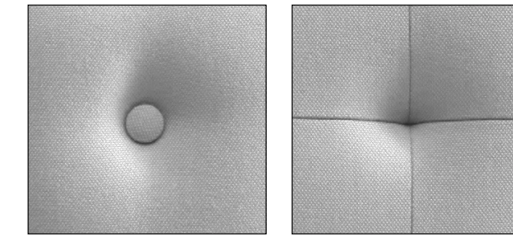

* See pricing pages for model dependent availability

POWER

Seating Under Mount
for models with and without arms

POWER PORTS

Position 2
(Right)

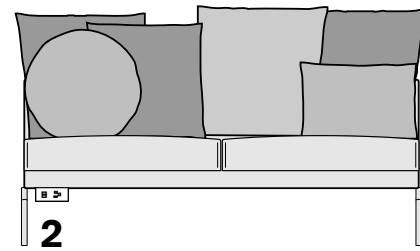

Position 1 and 2
(Left and Right)

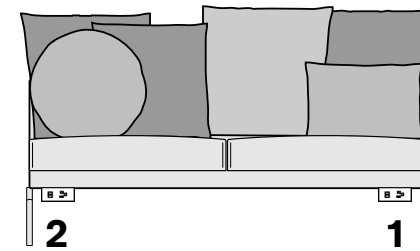

Position 1
(Left)

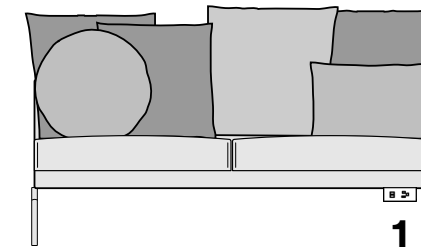

DAISY CHAIN POWER

Modular Power

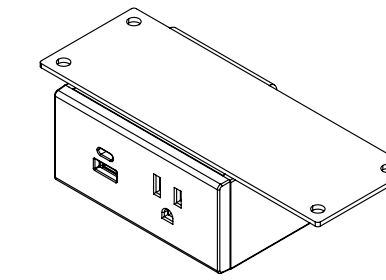

To Order Power Select Below

1. Mount Type

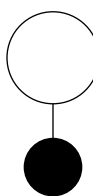

U	UNDER MOUNT
DCU	UNDER MOUNT, DAISY CHAIN

2. Unit Color

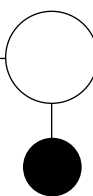

B	BLACK
G	GRAY
W	WHITE

3. Wire/Position

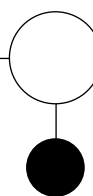

1	POSITION 1	+623
2	POSITION 2	+623
12	POSITION 1 AND 2	+1,245
H1	HARDWIRE POSITION 1	+816
H2	HARDWIRE POSITION 2	+816
H12	HARDWIRE POSITION 1 AND 2	+1,439

Due to frame configurations, power location will need to be verified by Stylex via layout drawing or CET Designer.

5. Daisy Chain Power

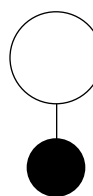

NYPBS	NYC POWER SYSTEM	
	SYSTEM INFEED (REQUIRED)	+194
	UNDERMOUNT POWER	+39
	JUMPER EXTENSION (5')	+138

Use CET to determine jumper length and configure daisy chain system. Pricing shown above is in addition to the individual power unit charges in steps 1-3.

PRODUCT INFORMATION

Power

Undermount units can be specified to be hardwired or with a 3-prong plug. The units have one USB-A port, one USB-C port, and a standard, grounded 3-prong electrical outlet. Additional power options include daisy chaining.

Cord Length

Both the standard cord and the conduit whip are 10 feet long. Other lengths may be available as a custom order.

Power Restrictions

Power is not available on corner seats, curved units, or tables. We also do not recommend power unit or daisy chain wires running under tables because they would be visible through the gaps on either side of the table.

Cable Management

All units ship with a cable mount and screw.

Daisy Chain Power

Undermount power can be daisy chained. Up to 8 units can be connected to the same system.

Power Order Entry

Due to frame configurations, power locations will need to be verified by Stylex via layout drawing or CET Designer. CET is required for modular power order entry. All daisy chain units are entered under 1 line item.

NYC

SPECIFICATION GUIDE: DIMENSIONS, SEATS AND BENCHES

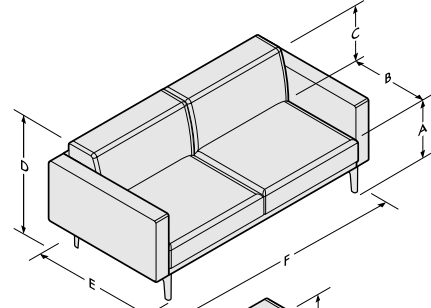
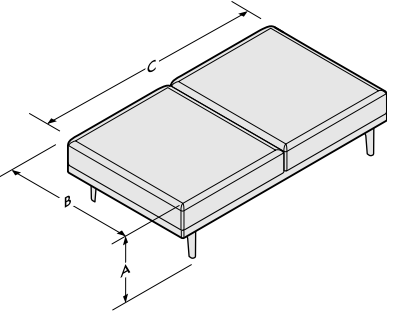
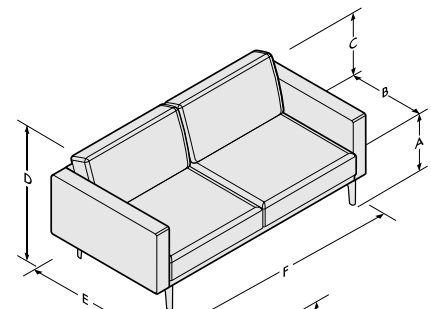
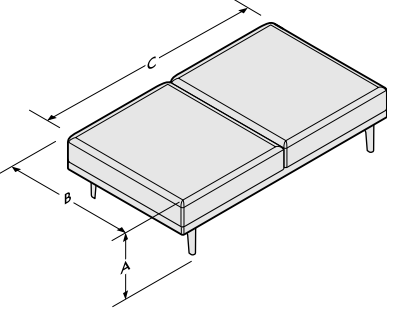
DIMENSIONS - WRAP-OVER		STAND ALONE			MODULAR			
Wrap-Over Seats A. Seat Height B. Seat Depth C. Back Height D. Overall Height E. Overall Depth F1. Overall Width (One-Seat) F2. Overall Width (Two-Seat) F3. Overall Width (Three-Seat)		Models with 4" Arms A. 17.5 B. 22.5 C. 12 D. 29.5 E. 34.5 F1. 38 F2. 68 F3. 98	Models with 6" Arms A. 17.5 B. 22.5 C. 12 D. 29.5 E. 34.5 F1. 42 F2. 72 F3. 102	Models with 9" Arms A. 17.5 B. 22.5 C. 12 D. 29.5 E. 34.5 F1. 48 F2. 78 F3. 108	Armless A. 17.5 B. 22.5 C. 12 D. 29.5 E. 34.5 F1. 30 F2. 60 F3. 90	90° Corner A. 17.5 B. 22.5 C. 12 D. 29.5 E. 34.5 F1. 47.88	135° Corner A. 17.5 B. 22.5 C. 12 D. 29.5 E. 34.5 F1. 42	150° Corner A. 17.5 B. 22.5 C. 12 D. 29.5 E. 34.5 F1. 40.38
	Wrap-Over Benches A. Overall Height B. Overall Depth C. Overall Width		One-Seat Bench A. 17.5 B. 33.5 C. 30	Two-Seat Bench A. 17.5 B. 33.5 C. 60	Three Seat Bench A. 17.5 B. 33.5 C. 90	In-line One-Seat Bench A. 17.5 B. 34.5 C. 30	In-line Two-Seat Bench A. 17.5 B. 34.5 C. 60	In-line Three-Seat Bench A. 17.5 B. 34.5 C. 90
DIMENSIONS - STANDARD		STAND ALONE			MODULAR			
Standard Seats A. Seat Height B. Seat Depth C. Back Height D. Overall Height E. Overall Depth F1. Overall Width (One-Seat) F2. Overall Width (Two-Seat) F3. Overall Width (Three-Seat)		Models with 4" Arms A. 17.5 B. 23.75 C. 13.25 D. 30.75 E. 34.5 F1. 38 F2. 68 F3. 98	Models with 6" Arms A. 17.5 B. 23.75 C. 13.25 D. 30.75 E. 34.5 F1. 42 F2. 72 F3. 102	Models with 9" Arms A. 17.5 B. 23.75 C. 13.25 D. 30.75 E. 34.5 F1. 48 F2. 78 F3. 108	Armless A. 17.5 B. 23.75 C. 13.25 D. 30.75 E. 34.5 F1. 30 F2. 60 F3. 90	90° Corner A. 17.5 B. 23.75 C. 13.25 D. 30.75 E. 34.5 F1. 47.88	135° Corner A. 17.5 B. 23.75 C. 13.25 D. 30.75 E. 34.5 F1. 42	150° Corner A. 17.5 B. 23.75 C. 13.25 D. 30.75 E. 34.5 F1. 40.38
	Standard Benches A. Overall Height B. Overall Depth C. Overall Width		One-Seat Bench A. 17.5 B. 33.5 C. 30	Two-Seat Bench A. 17.5 B. 33.5 C. 60	Three Seat Bench A. 17.5 B. 33.5 C. 90	In-line One-Seat Bench A. 17.5 B. 34.5 C. 30	In-line Two-Seat Bench A. 17.5 B. 34.5 C. 60	In-line Three-Seat Bench A. 17.5 B. 34.5 C. 90

NYC

SPECIFICATION GUIDE: DIMENSIONS, SEATS AND BENCHES

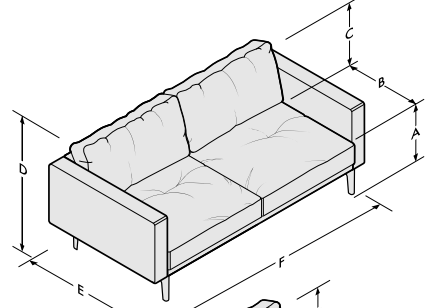
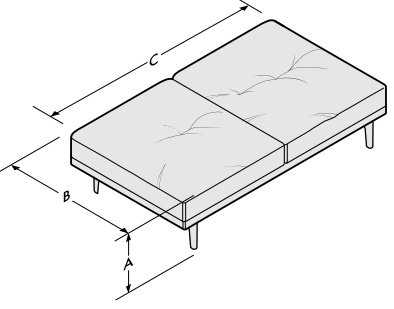
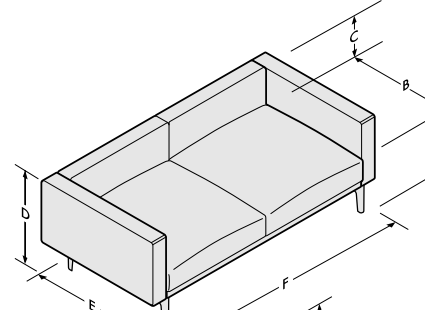
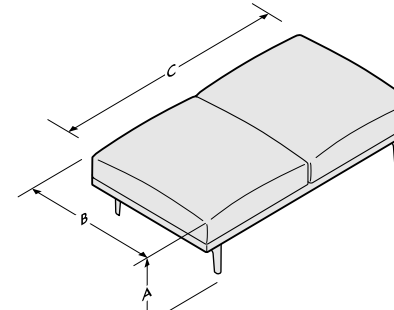
DIMENSIONS - RELAXED		STAND ALONE						MODULAR							
Relaxed Seats A. Seat Height B. Seat Depth C. Back Height D. Overall Height E. Overall Depth F1. Overall Width (One-Seat) F2. Overall Width (Two-Seat) F3. Overall Width (Three-Seat)		Models with 4" Arms		Models with 6" Arms		Models with 9" Arms		Armless		90° Corner		135° Corner		150° Corner	
		A. 17.5 B. 22.5 C. 12 D. 29.5 E. 34.5 F1. 38 F2. 68 F3. 98	A. 17.5 B. 22.5 C. 12 D. 29.5 E. 34.5 F1. 42 F2. 72 F3. 102	A. 17.5 B. 22.5 C. 12 D. 29.5 E. 34.5 F1. 48 F2. 78 F3. 108	A. 17.5 B. 22.5 C. 12 D. 29.5 E. 34.5 F1. 30 F2. 60 F3. 90	A. 17.5 B. 22.5 C. 12 D. 29.5 E. 34.5 F1. 47.88	A. 17.5 B. 22.5 C. 12 D. 29.5 E. 34.5 F1. 42	A. 17.5 B. 22.5 C. 12 D. 29.5 E. 34.5 F1. 40.38							
Relaxed Benches A. Overall Height B. Overall Depth C. Overall Width		One-Seat Bench		Two-Seat Bench		Three Seat Bench		In-line One-Seat Bench		In-line Two-Seat Bench		In-line Three-Seat Bench		In-line 2/3-Seat Bench	
		A. 16.5 B. 33.5 C. 30	A. 16.5 B. 33.5 C. 60	A. 16.5 B. 33.5 C. 90	A. 16.5 B. 34.5 C. 30	A. 16.5 B. 34.5 C. 60	A. 16.5 B. 34.5 C. 90	A. 16.5 B. 34.5 C. 20							
DIMENSIONS - LOOSE		STAND ALONE						MODULAR							
Loose Seats With and Without Cushions A. Seat Height B. Seat Depth C. Back Height D. Overall Height E. Overall Depth F1. Overall Width (One-Seat) F2. Overall Width (Two-Seat) F3. Overall Width (Three-Seat)		4" Arms	4" Arms	6" Arms	6" Arms	9" Arms	9" Arms	Armless	Armless	90° Corner	90° Corner	135° Corner	135° Corner	150° Corner	150° Corner
		A. 17.5 B. 30.5 C. 9.75 D. 25.25 E. 34.5 F1. 38 F2. 68 F3. 98	No Cushions A. 17.5 B. 22 C. 13.5 D. 31 E. 34.5 F1. 38 F2. 68 F3. 98	Cushions A. 17.5 B. 22 C. 13.5 D. 31 E. 34.5 F1. 38 F2. 68 F3. 98	No Cushions A. 17.5 B. 30.5 C. 9.75 D. 25.25 E. 34.5 F1. 42 F2. 72 F3. 102	Cushions A. 17.5 B. 22 C. 13.5 D. 31 E. 34.5 F1. 42 F2. 72 F3. 102	No Cushions A. 17.5 B. 30.5 C. 9.75 D. 25.25 E. 34.5 F1. 48 F2. 78 F3. 108	Cushions A. 17.5 B. 22 C. 13.5 D. 31 E. 34.5 F1. 48 F2. 78 F3. 108	No Cushions A. 17.5 B. 30.5 C. 9.75 D. 25.25 E. 34.5 F1. 30 F2. 60 F3. 90	Cushions A. 17.5 B. 22 C. 13.5 D. 31 E. 34.5 F1. 30 F2. 60 F3. 90	No Cushions A. 17.5 B. 30.5 C. 9.75 D. 25.25 E. 34.5 F1. 47.88	Cushions A. 17.5 B. 22 C. 13.5 D. 31 E. 34.5 F1. 47.88	No Cushions A. 17.5 B. 30.5 C. 9.75 D. 25.25 E. 34.5 F1. 42	Cushions A. 17.5 B. 22 C. 13.5 D. 31 E. 34.5 F1. 42	No Cushions A. 17.5 B. 30.5 C. 9.75 D. 25.25 E. 34.5 F1. 40.38
Loose Benches A. Overall Height B. Overall Depth C. Overall Width		One-Seat Bench		Two-Seat Bench		Three Seat Bench		In-line One-Seat Bench		In-line Two-Seat Bench		In-line Three-Seat Bench		In-line 2/3-Seat Bench	
		A. 17.5 B. 33.5 C. 30	A. 17.5 B. 33.5 C. 60	A. 17.5 B. 33.5 C. 90	A. 17.5 B. 34.5 C. 30	A. 17.5 B. 34.5 C. 60	A. 17.5 B. 34.5 C. 90	A. 17.5 B. 34.5 C. 20							

NYC

SPECIFICATION GUIDE: DIMENSIONS, ARMS AND TABLES

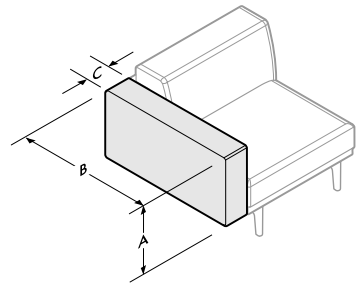
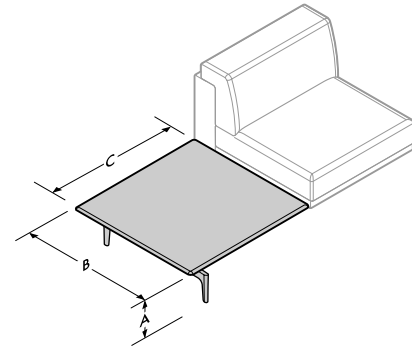
DIMENSIONS - TABLES AND ARMS	STAND ALONE			MODULAR			
<p>Arms</p> <p>A. Arm Height B. Arm Depth C. Arm Width</p> 				<p>4" Arms</p> <p>A. 16.5 B. 33.5 C. 4</p>	<p>6" Arms</p> <p>A. 16.5 B. 33.5 C. 6</p>	<p>9" Arms</p> <p>A. 16.5 B. 33.5 C. 9</p>	
<p>Tables</p> <p>A. Overall Height B. Overall Depth C. Overall Width</p> 	<p>Bench Corner Table</p> <p>A. 11.5 B. 33.5 C. 33.5</p>			<p>In-line Corner Table</p> <p>A. 11.5 B. 34.5 C. 34.5</p>	<p>In-line Full Table</p> <p>A. 11.5 B. 33.5 C. 33.5</p>	<p>In-line 2/3 Table</p> <p>A. 11.5 B. 33.5 C. 20</p>	

NYC

SPECIFICATION GUIDE: IDEA STARTERS AND ORDERING GUIDE

IDEA STARTERS

Idea Starter 1



Idea Starter 2



Idea Starter 3



Idea Starter 4



Idea Starter 5



Idea Starter 6



ORDERING GUIDE

Modular Ordering and Specification

While NYC offers traditional stand-alone units, it is at the same time fundamentally flexible. The Modular models have all been designed to encourage creation of a wide variety of set-ups. To ensure clarity when ordering modular set-ups, it is critical that line items should be listed in the order in which they will be connected from left end (seated perspective) to right end. Modular Benches must be connected to other units. Modular Arms can only be added to the outside ends of any modular set-up. Seating orientation of a set-up (direction in which the user faces) can only be changed on either side of a table located in the middle of a set-up.

Leg Placement

NYC is a rail-supported modular seating system. The placement and number of legs will depend on each layout. Prior to order entry Stylex will provide a dimensioned layout that depicts the specific leg placement for approval. Order leadtime will start from the time Stylex Customer Service has received back a signed copy of this layout.

NYC Loose Cushions and Throw Pillows

NYC Loose is not only modular, it also offers tremendous design flexibility. NYC Loose may be ordered without any back cushions or throw pillows, allowing the freedom to obtain back support from any supplier.

At the same time, you may decide to buy either attached back cushions or loose throw pillows from Stylex. Back cushions come in two widths: Partial (27" Wide) and Full (30" Wide). Throw pillows, unlike back cushions, are not attached to the unit and may be freely rearranged. Throw pillows are available in a variety of sizes and seam styles.

Idea Starters Online and in CET

At Stylex, we have a constant eye towards making our products easy to specify. Our Design Application team is working on layouts every day, so we have built a library online of the most requested layouts, with all the accompanying information, files, and pricing. We believe these will make our products easier to specify, and in turn help kick start your project. You can also find these in CET, please check out our 'Idea Starters' tab on for the easiest way to drag-and-drop right into your layout. Visit [Stylexdesign.com/idea-starters](https://stylexdesign.com/idea-starters) to get started.

NYC

SPECIFICATION GUIDE: HOW TO ORDER, SEATING

MODEL CODE BREAKDOWN - SEATING

Sample Model Code: NY121B24C1ALUB1CTCOM

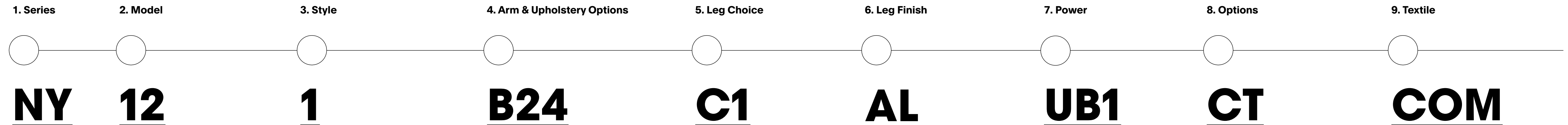

1. Series	2. Model	3. Style	4. Arm & Upholstery Options	5. Leg Choice	6. Leg Finish	7. Power	8. Options	9. Textile
NY	12	1	B24	C1	AL	UB1	CT	COM
Series NY NYC	Model Stand Alone 01 ONE-SEAT BENCH 02 TWO-SEAT BENCH 03 THREE-EAT BENCH 11 CLUB CHAIR 12 TWO-SEAT SOFA 13 THREE-SEAT SOFA Modular 04 ONE-SEAT INLINE BENCH 05 TWO-SEAT INLINE BENCH 05 THREE-SEAT INLINE BENCH 07 2/3-SEAT INLINE BENCH 11 ONE-SEAT UNIT 12 TWO-SEAT UNIT 13 THREE-SEAT UNIT 14 135 DEGREE CORNER 15 150 DEGREE CORNER 16 90 DEGREE CORNER	Style 1 WRAP-OVER 2 STANDARD 3 RELAXED 4 LOOSE, PARTIAL CUSHION 5 LOOSE, FULL CUSHION 6 LOOSE, NO CUSHION	Arm Thickness 24 4" ARM 26 6" ARM 29 9" ARM B24 4" ARM, BOTH B26 6" ARM, BOTH B29 9" ARM, BOTH Arm Location L LEFT POSITION WHEN SEATED R RIGHT POSITION WHEN SEATED Note: Predetermined arms only available with Standalone units. Modular units must specify arms separately. Upholstery Style DF DUAL UPHOLSTERY	Leg Choice C1 ALUMINUM LEGS WITH ADJUSTABLE GLIDES	Leg Finish Standard Powder Coat BL BLUE BM BLACK MATTE BR BRASS BT BLACK TWILIGHT CP CHAMPAGNE DB DARK BRONZE DG DARK GRAY DP DUSTY PINK FG FOREST GREEN LG LIGHT GRAY MG MEADOW GREEN MK MILK MS METALLIC SILVER NK NICKLE NV NAVY OR ORANGE PY PALE YELLOW RD RED RO RED ORANGE RR RUSTY RED SB SOFT BLUE SD SAND TC TERRACOTTA TP TAUPE TS TEXTURED SLATE YL YELLOW Polished Metal AL POLISHED ALUMINUM/ CHROME Note: Chrome rails with polished aluminum legs	Power Mount Type U UNDERMOUNT Color B BLACK G GRAY W WHITE Cord ~ STANDARD H HARDWIRE Location 1 POSITION 1 (LEFT) 2 POSITION 2 (RIGHT) 12 POSITION 1 & 2	Options Welt Cord W1 WELT CORD ON SEAT W3 WELT CORD ON SEAT AND BACK Sewn Tuft T1 TUFTED SEAT T3 TUFTED SEAT AND BACK Button Tuft B2 BUTTON TUFTED BACK Contrasting Thread CT CONTRASTING THREAD	Textile Grades COM CUSTOMER'S OWN MATERIAL A GRADE A B GRADE B C GRADE C D GRADE D E GRADE E F GRADE F G GRADE G H GRADE H I GRADE I J GRADE J K GRADE K L GRADE L M GRADE M Leather Grades COL CUSTOMER'S OWN LEATHER W GRADE W X GRADE X Y GRADE Y E1 GRADE E1 E2 GRADE E2 Note: Select highest grade in the case of dual upholstery

NYC

SPECIFICATION GUIDE: HOW TO ORDER, TABLES

MODEL CODE BREAKDOWN - TABLES

Sample Model Code: **NY51CS51C1AL**



1. Series

2. Model

3. Top

4. Leg Choice

6. Leg Finish

NY

51

CS51

C1

AL

Series

NY NYC

Model

- 51 FULL INLINE TABLE
- 53 2/3 INLINE TABLE
- 55 CORNER INLINE TABLE
- 57 BENCH CORNER TABLE

Top

Caesarstone Tops

- CS51 JET BLACK
- CS52 SLEEK CONCRETE
- CS65 PURE WHITE
- CS96 STATUARIO NUVO

Other

- COT CUSTOMER'S OWN TOP

Leg Choice

- C1 ALUMINUM LEGS WITH ADJUSTABLE GLIDES

Leg Finish

Standard Powder Coat

- BL BLUE
- BM BLACK MATTE
- BR BRASS
- BT BLACK TWILIGHT
- CP CHAMPAGNE
- DB DARK BRONZE
- DG DARK GRAY
- DP DUSTY PINK
- FG FOREST GREEN
- LG LIGHT GRAY
- MG MEADOW GREEN
- MK MILK
- MS METALLIC SILVER
- NK NICKLE
- NV NAVY
- OR ORANGE
- PY PALE YELLOW
- RD RED
- RO RED ORANGE
- RR RUSTY RED
- SB SOFT BLUE
- SD SAND
- TC TERRACOTTA
- TP TAUPE
- TS TEXTURED SLATE
- YL YELLOW

Polished Metal

- AL POLISHED ALUMINUM/CHROME

Note: Chrome rails with polished aluminum legs

NYC

SPECIFICATION GUIDE: HOW TO ORDER, THROW PILLOWS

MODEL CODE BREAKDOWN - THROW PILLOWS

Sample Model Code: NY711CTCOM

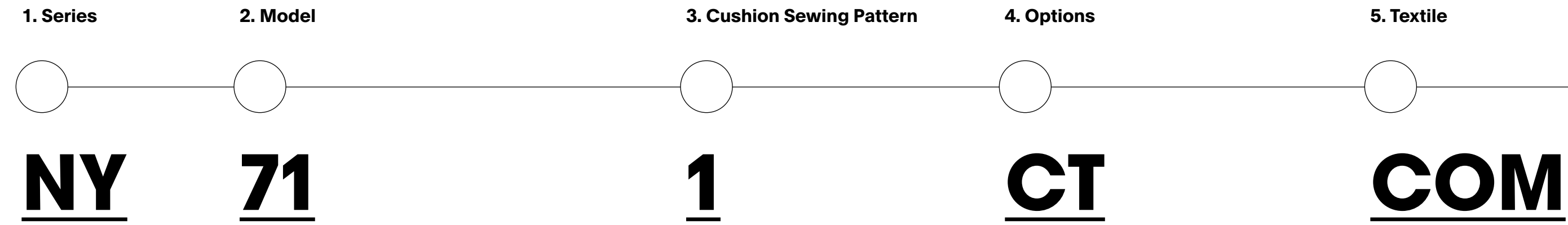

Series

NY NYC

Model

71 24"X 24" THROW PILLOW
72 20"X 20" THROW PILLOW
73 18"X 18" THROW PILLOW
74 16"X 16" THROW PILLOW
75 14"X 20" THROW PILLOW
76 16"X 22" THROW PILLOW
77 18" ROUND THROW PILLOW

Upholstery Options

1 GUSSET
2 PINCH
3 PANEL

Options

CT CONTRASTING THREAD

Textile Grades

COM CUSTOMER'S OWN MATERIAL
A GRADE A
B GRADE B
C GRADE C
D GRADE D
E GRADE E
F GRADE F
G GRADE G
H GRADE H
I GRADE I
J GRADE J
K GRADE K
L GRADE L
M GRADE M

Leather Grades

COL CUSTOMER'S OWN LEATHER
W GRADE W
X GRADE X
Y GRADE Y
E1 GRADE E1
E2 GRADE E2

NYC

STANDARD: MODULAR SEATING

TITLE	SERIES	MODEL	STYLE	DIMENSIONS	COM	COL	Textile Upholstery Grades										Leather Upholstery Grades								
							YDG	SQFT	COM	A	B	C	D	E	F	G	H	I	J	K	L	M	W	X	Y
Modular One-Seat Unit Standard	NY	11	2	30W x 34.5D x 30.75H	4.5	60	3,411	3,767	3,960	4,148	4,341	4,533	4,746	4,957	5,206	5,529	5,916	6,304	6,681	7,070	4,951	5,432	6,657	7,377	8,700
Modular Two-Seat Unit Standard	NY	12	2	60W x 34.5D x 30.75H	8	117	5,489	6,164	6,533	6,890	7,257	7,625	8,028	8,433	8,905	9,525	10,259	10,996	11,720	12,456	8,496	9,434	11,831	13,241	15,824
Modular Three-Seat Unit Standard	NY	13	2	90W x 34.5D x 30.75H	12	171	7,565	8,581	9,131	9,666	10,218	10,771	11,375	11,981	12,691	13,619	14,723	15,825	16,912	18,016	11,992	13,375	16,899	18,972	22,775

To Order Select Below

1. Series/Model/Style

NY112	NYC Modular, One-Seat Unit, Standard
NY122	NYC Modular, Two-Seat Unit, Standard
NY132	NYC Modular, Three-Seat Unit, Standard

2. Upholstery Style

DF	DUAL UPHOLSTERY	Dual upholstery option allows for a second textile to be applied to NYC seats and backs.
	One-Seat Plinth	2.0 yds
	Seat and Back	3.5 yds
	Two-Seat Plinth	3.0 yds
	Seats and Backs	6.0 yds
	Three-Seat Plinth	5.0 yds
	Seats and Backs	8.0 yds

3. Leg Choice

C1	ALUMINUM LEGS WITH ADJUSTABLE GLIDES
----	---

4. Leg Finish

BL	BLUE	NK	NICKEL	
BM	BLACK MATTE	NV	NAVY	
BR	BRASS	OR	ORANGE	
BT	BLACK TWILIGHT	PY	PALE YELLOW	
CP	CHAMPAGNE	RD	RED	
DB	DARK BRONZE	RO	RED ORANGE	
DG	DARK GRAY	RR	RUSTY RED	
DP	DUSTY PINK	SB	SOFT BLUE	
FG	FOREST GREEN	SD	SAND	
LG	LIGHT GRAY	TC	TERRACOTTA	
MG	MEADOW GREEN	TP	TAUPE	
MK	MILK	TS	TEXTURED SLATE	
MS	METALLIC SILVER	YL	YELLOW	
	Polished Metal	1-Seat	2-Seat	3-Seat
AL	POLISHED ALUMINUM/CHROME	+223	+223	+297

Chrome rails with polished aluminum legs.

5. Power

Power
Refer to power ordering steps on [page 7](#).

6. Options

WI	WELT CORD ON SEAT	+59	+118	+176
W3	WELT CORD ON SEAT AND BACK	+104	+208	+312
	Sewn Tuft			
T1	TUFTED SEAT	+59	+118	+176
T3	TUFTED SEAT AND BACK	+104	+208	+312
	Button Tuft			
B2	BUTTON TUFTED BACK	+59	+118	+176
	Options			
CT	CONTRASTING THREAD			

Important Option Parameters

Welt cords and sewn tufts can be specified on the same cushions. Button Tufts (backs only) can be combined with tufted seats and welt cords. Contrasting thread is not available with the welt cord option.

7. Upholstery

Upholstery
See general information section for details on textile program and COM/ COL information.

Yardages provided are for non-directional fabrics that are applied railroaded. Directional fabrics may require additional yardage.

When specifying dual upholstery models, the higher of the two grades will determine price.

Tufting will help evenly distribute the wrinkling that will occur with certain leathers and fabrics.

NYC

STANDARD: MODULAR CORNERS

TITLE	SERIES	MODEL	STYLE	DIMENSIONS	COM	COL	Textile Upholstery Grades										Leather Upholstery Grades								
							YDG	SQFT	COM	A	B	C	D	E	F	G	H	I	J	K	L	M	W	X	Y
Modular 135 Degree Corner Standard	NY	14	2	42W x 34.5D x 30.75H	6	65	3,856	4,364	4,639	4,909	5,185	5,459	5,761	6,065	6,421	6,884	7,437	7,988	8,531	9,083	5,542	6,066	7,410	8,195	9,643
Modular 150 Degree Corner Standard	NY	15	2	40.38W x 34.5D x 30.75H	6	65	3,856	4,364	4,639	4,909	5,185	5,459	5,761	6,065	6,421	6,884	7,437	7,988	8,531	9,083	5,542	6,066	7,410	8,195	9,643
Modular 90 Degree Corner Standard	NY	16	2	47.88W x 34.5D x 30.75H	7	89	4,153	4,678	4,963	5,240	5,525	5,809	6,122	6,435	6,803	7,282	7,852	8,422	8,983	9,554	6,461	7,183	9,022	10,105	12,088

To Order Select Below

1. Series/Model/Style

- NY142
NYC Modular, 135° Corner, Standard
- NY152
NYC Modular, 150° Corner, Standard
- NY162
NYC Modular, 90° Corner, Standard

2. Upholstery Style

- Upholstery Style**
DF DUAL UPHOLSTERY
Dual upholstery option allows for a second textile to be applied to NYC seats and backs.
- 135° Corner**
Plinth 3.0 yds
Seat and Back 4.0 yds
- 150° Corner**
Plinth 3.0 yds
Seat and Back 4.0 yds
- 90° Corner**
Plinth 3.0 yds
Seat and Backs 4.0 yds

3. Leg Choice

- Leg Choice**
C1 ALUMINUM LEGS WITH ADJUSTABLE GLIDES

4. Leg Finish

- Standard Powder Coat**
 - BL BLUE
 - BM BLACK MATTE
 - BR BRASS
 - BT BLACK TWILIGHT
 - CP CHAMPAGNE
 - DB DARK BRONZE
 - DG DARK GRAY
 - DP DUSTY PINK
 - FG FOREST GREEN
 - LG LIGHT GRAY
 - MG MEADOW GREEN
 - MK MILK
 - MS METALLIC SILVER
- Polished Metal**
 - NK NICKEL
 - NV NAVY
 - OR ORANGE
 - PY PALE YELLOW
 - RD RED
 - RO RED ORANGE
 - RR RUSTY RED
 - SB SOFT BLUE
 - SD SAND
 - TC TERRACOTTA
 - TP TAUPE
 - TS TEXTURED SLATE
 - YL YELLOW
- AL POLISHED ALUMINUM/CHROME +223**

Chrome rails with polished aluminum legs.

5. Power

- Power**
Refer to power ordering steps on page 7.

6. Options

- Welt Cord**
 - WI WELT CORD ON SEAT +59
 - W3 WELT CORD ON SEAT AND BACK +147
- Sewn Tuft**
 - T1 TUFTED SEAT +59
 - T3 TUFTED SEAT AND BACK +147
- Button Tuft**
 - B2 BUTTON TUFTED BACK +118
- Options**
 - CT CONTRASTING THREAD

Important Option Parameters

Welt cords and sewn tufts can be specified on the same cushions. Button Tufts (backs only) can be combined with tufted seats and welt cords. Contrasting thread is not available with the welt cord option.

7. Upholstery

- Upholstery**
See general information section for details on textile program and COM/COL information.
Yardages provided are for non-directional fabrics that are applied railroaded. Directional fabrics may require additional yardage.
When specifying dual upholstery models, the higher of the two grades will determine price.
Tufting will help evenly distribute the wrinkling that will occur with certain leathers and fabrics.

NYC

STANDARD: MODULAR IN-LINE BENCHES

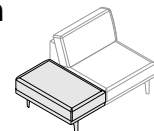
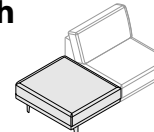
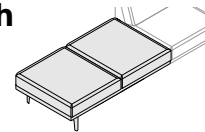
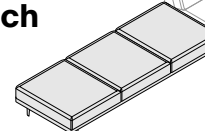
TITLE	SERIES	MODEL	STYLE	DIMENSIONS	COM	COL	Textile Upholstery Grades										Leather Upholstery Grades								
							YDG	SQFT	COM	A	B	C	D	E	F	G	H	I	J	K	L	M	W	X	Y
Modular 2/3-Seat In-line Bench Standard 	NY	07	2	20W x 34.5D x 17.5H	2.5	30	1,831	2,004	2,099	2,191	2,285	2,381	2,484	2,589	2,709	2,868	3,058	3,247	3,432	3,623	2,636	2,889	3,529	3,908	4,597
Modular One-Seat In-line Bench Standard 	NY	04	2	30W x 34.5D x 17.5H	3	40	2,137	2,398	2,539	2,676	2,819	2,961	3,114	3,272	3,455	3,694	3,975	4,259	4,539	4,824	3,190	3,518	4,361	4,851	5,758
Modular Two-Seat In-line Bench Standard 	NY	05	2	60W x 34.5D x 17.5H	5.5	74	3,357	3,793	4,028	4,257	4,494	4,730	4,990	5,248	5,553	5,950	6,424	6,899	7,363	7,836	5,299	5,903	7,452	8,360	10,030
Modular Three-Seat In-line Bench Standard 	NY	06	2	90W x 34.5D x 17.5H	7.5	100	4,881	5,492	5,823	6,143	6,474	6,805	7,168	7,532	7,960	8,513	9,176	9,840	10,491	11,154	7,707	8,588	10,840	12,163	14,589

To Order Select Below

1. Series/Model/Style

- NY072
NYC Modular, 2/3-Seat In-line Bench, Standard
- NY042
NYC Modular, One-Seat In-line Bench, Standard
- NY052
NYC Modular, Two-Seat In-line Bench, Standard
- NY062
NYC Modular, Three-Seat In-line Bench, Standard

2. Upholstery Style

- Upholstery Style**
DF DUAL UPHOLSTERY
Dual upholstery option allows for a second textile to be applied to NYC seats and backs.
- 2/3-Seat In-Line Bench**
Plinth 1.5 yds
Seat 2.0 yds
- One-Seat In-Line Bench**
Plinth 1.5 yds
Seat 2.5 yds
- Two-Seat In-Line Bench**
Plinth 2.0 yds
Seats 4.0 yds
- Three-Seat In-Line Bench**
Plinth 2.0 yds
Seats 6.0 yds

3. Leg Choice

- Leg Choice**
C1 ALUMINUM LEGS WITH ADJUSTABLE GLIDES

4. Leg Finish

- Standard Powder Coat**

BL	BLUE	NK	NICKEL
BM	BLACK MATTE	NV	NAVY
BR	BRASS	OR	ORANGE
BT	BLACK TWILIGHT	PY	PALE YELLOW
CP	CHAMPAGNE	RD	RED
DB	DARK BRONZE	RO	RED ORANGE
DG	DARK GRAY	RR	RUSTY RED
DP	DUSTY PINK	SB	SOFT BLUE
FG	FOREST GREEN	SD	SAND
LG	LIGHT GRAY	TC	TERRACOTTA
MG	MEADOW GREEN	TP	TAUPE
MK	MILK	TS	TEXTURED SLATE
MS	METALLIC SILVER	YL	YELLOW
- Polished Metal**

		2/3-Seat 1-Seat	2-Seat	3-Seat
AL	POLISHED ALUMINUM/CHROME	+223	+223	+297

Chrome rails with polished aluminum legs.

5. Power

- Power**
Refer to power ordering steps on [page 7](#).

6. Options

- Welt Cord**

WI	WELT CORD ON SEAT	+59	+118	+176
----	-------------------	------------	-------------	-------------
 - Sewn Tuft**

T1	TUFTED SEAT	+59	+118	+176
----	-------------	------------	-------------	-------------
 - Options**

CT	CONTRASTING THREAD			
----	--------------------	--	--	--
- Important Option Parameters**
Welt cords and sewn tufts can be specified on the same cushions. Contrasting thread is not available with the welt cord option.

7. Upholstery

- Upholstery**
See general information section for details on textile program and COM/ COL information.

Yardages provided are for non-directional fabrics that are applied railroaded. Directional fabrics may require additional yardage.

When specifying dual upholstery models, the higher of the two grades will determine price.

Tufting will help evenly distribute the wrinkling that will occur with certain leathers and fabrics.

NYC

STANDARD: STAND ALONE SEATING, 4IN ARM

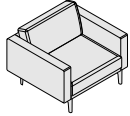
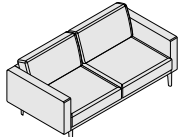
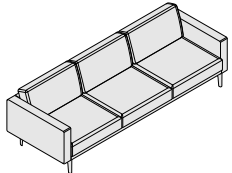
TITLE	SERIES	MODEL	STYLE	ARM	DIMENSIONS	COM	COL	Textile Upholstery Grades										Leather Upholstery Grades								
								YDG	SQFT	COM	A	B	C	D	E	F	G	H	I	J	K	L	M	W	X	Y
Stand Alone Club Chair Standard 4in Arm 	NY	11	2	B24	38W x 34.5D x 30.75H	7	98	4,385	4,918	5,207	5,488	5,777	6,067	6,383	6,702	7,077	7,560	8,141	8,720	9,290	9,870	6,977	7,790	9,854	11,069	13,297
Stand Alone Two-Seat Sofa Standard 4in Arm 	NY	12	2	B24	68W x 34.5D x 30.75H	11	154	6,461	7,308	7,767	8,211	8,672	9,131	9,636	10,140	10,733	11,506	12,426	13,344	14,250	15,169	10,449	11,695	14,872	16,740	20,166
Stand Alone Three-Seat Sofa Standard 4in Arm 	NY	13	2	B24	98W x 34.5D x 30.75H	14	209	8,539	9,807	10,498	11,165	11,855	12,544	13,300	14,057	14,947	16,103	17,483	18,864	20,222	21,600	13,946	15,633	19,941	22,473	27,118

To Order Select Below

1. Series/Model/Style/Arm

- NY112B24
NYC Stand Alone, Club Chair Standard, 4in Arm
- NY122B24
NYC Stand Alone, Two-Seat Sofa, Standard, 4in Arm
- NY132B24
NYC Stand Alone, Three-Seat Sofa, Standard, 4in Arm

2. Upholstery Style

- Upholstery Style**
DF DUAL UPHOLSTERY
Dual upholstery option allows for a second textile to be applied to NYC seats and backs.
- Club Chair**
Plinth and Arms 4.5 yds
Seat and Back 3.5 yds
- Two-Seat Sofa**
Plinth and Arms 5.5 yds
Seats and Backs 6.0 yds
- Three-Seat Sofa**
Plinth and Arms 6.5 yds
Seats and Backs 9.0 yds

3. Leg Choice

- Leg Choice**
C1 ALUMINUM LEGS WITH ADJUSTABLE GLIDES

4. Leg Finish

- Standard Powder Coat**

BL	BLUE	NK	NICKEL
BM	BLACK MATTE	NV	NAVY
BR	BRASS	OR	ORANGE
BT	BLACK TWILIGHT	PY	PALE YELLOW
CP	CHAMPAGNE	RD	RED
DB	DARK BRONZE	RO	RED ORANGE
DG	DARK GRAY	RR	RUSTY RED
DP	DUSTY PINK	SB	SOFT BLUE
FG	FOREST GREEN	SD	SAND
LG	LIGHT GRAY	TC	TERRACOTTA
MG	MEADOW GREEN	TP	TAUPE
MK	MILK	TS	TEXTURED SLATE
MS	METALLIC SILVER	YL	YELLOW
- Polished Metal**

		1-Seat	2-Seat	3-Seat
AL	POLISHED ALUMINUM/CHROME	+223	+223	+297

Chrome rails with polished aluminum legs.

5. Power

- Power**
Refer to power ordering steps on [page 7](#).

6. Options

- Welt Cord**

WI	WELT CORD ON SEAT	+59	+118	+176
W3	WELT CORD ON SEAT AND BACK	+104	+208	+312
- Sewn Tuft**

T1	TUFTED SEAT	+59	+118	+176
T3	TUFTED SEAT AND BACK	+104	+208	+312
- Button Tuft**

B2	BUTTON TUFTED BACK	+59	+118	+176
----	--------------------	------------	-------------	-------------
- Options**

CT	CONTRASTING THREAD
----	--------------------

Important Option Parameters

Welt cords and sewn tufts can be specified on the same cushions. Button Tufts (backs only) can be combined with tufted seats and welt cords. Contrasting thread is not available with the welt cord option.

7. Upholstery

- Upholstery**
See [general information section](#) for details on textile program and COM/ COL information.

Yardages provided are for non-directional fabrics that are applied railroaded. Directional fabrics may require additional yardage.

When specifying dual upholstery models, the higher of the two grades will determine price.

Tufting will help evenly distribute the wrinkling that will occur with certain leathers and fabrics.

NYC

STANDARD: STAND ALONE SEATING, 6IN ARM

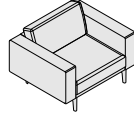
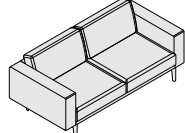
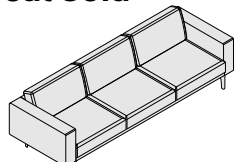
TITLE	SERIES	MODEL	STYLE	ARM	DIMENSIONS	COM YDG	COL SQFT	Textile Upholstery Grades											Leather Upholstery Grades							
								COM	A	B	C	D	E	F	G	H	I	J	K	L	M	W	X	Y	E1	E2
Stand Alone Club Chair Standard 6in Arm 	NY	11	2	B26	42W x 34.5D x 30.75H	7	98	4,385	4,918	5,207	5,488	5,777	6,067	6,383	6,702	7,077	7,560	8,141	8,720	9,290	9,870	6,977	7,790	9,854	11,069	13,297
Stand Alone Two-Seat Sofa Standard 6in Arm 	NY	12	2	B26	72W x 34.5D x 30.75H	11	154	6,461	7,308	7,767	8,211	8,672	9,131	9,636	10,140	10,733	11,506	12,426	13,344	14,250	15,169	10,449	11,695	14,872	16,740	20,166
Stand Alone Three-Seat Sofa Standard 6in Arm 	NY	13	2	B26	102W x 34.5D x 30.75H	14	209	8,539	9,807	10,498	11,165	11,855	12,544	13,300	14,057	14,947	16,103	17,483	18,864	20,222	21,600	13,946	15,633	19,941	22,473	27,118

To Order Select Below

1. Series/Model/Style/Arm

- NY112B26
NYC Stand Alone, Club Chair Standard, 6in Arm
- NY122B26
NYC Stand Alone, Two-Seat Sofa, Standard, 6in Arm
- NY132B26
NYC Stand Alone, Three-Seat Sofa, Standard, 6in Arm

2. Upholstery Style

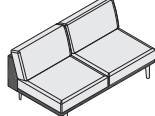
- DF DUAL UPHOLSTERY
Dual upholstery option allows for a second textile to be applied to NYC seats and backs.
- 
Club Chair
Plinth and Arms 4.5 yds
Seat and Back 3.5 yds
- Two-Seat Sofa**
Plinth and Arms 5.5 yds
Seats and Backs 6.0 yds
- Three-Seat Sofa**
Plinth and Arms 6.5 yds
Seats and Backs 8.0 yds

3. Leg Choice

- C1 ALUMINUM LEGS WITH ADJUSTABLE GLIDES

4. Leg Finish

- Standard Powder Coat**
 - BL BLUE
 - BM BLACK MATTE
 - BR BRASS
 - BT BLACK TWILIGHT
 - CP CHAMPAGNE
 - DB DARK BRONZE
 - DG DARK GRAY
 - DP DUSTY PINK
 - FG FOREST GREEN
 - LG LIGHT GRAY
 - MG MEADOW GREEN
 - MK MILK
 - MS METALLIC SILVER
- Polished Metal**

	1-Seat	2-Seat	3-Seat
AL POLISHED ALUMINUM/CHROME	+223	+223	+297

Chrome rails with polished aluminum legs.

5. Power

- Power**
Refer to power ordering steps on page 7.

6. Options

- Welt Cord**

	1-Seat	2-Seat	3-Seat
WI WELT CORD ON SEAT	+59	+118	+176
W3 WELT CORD ON SEAT AND BACK	+104	+208	+312
- Sewn Tuft**

	1-Seat	2-Seat	3-Seat
T1 TUFTED SEAT	+59	+118	+176
T3 TUFTED SEAT AND BACK	+104	+208	+312
- Button Tuft**

	1-Seat	2-Seat	3-Seat
B2 BUTTON TUFTED BACK	+59	+118	+176
- Options**

CT CONTRASTING THREAD

Important Option Parameters

Welt cords and sewn tufts can be specified on the same cushions. Button Tufts (backs only) can be combined with tufted seats and welt cords. Contrasting thread is not available with the welt cord option.

7. Upholstery

- Upholstery**
See general information section for details on textile program and COM/ COL information.
- Yardages provided are for non-directional fabrics that are applied railroaded. Directional fabrics may require additional yardage.
- When specifying dual upholstery models, the higher of the two grades will determine price.
- Tufting will help evenly distribute the wrinkling that will occur with certain leathers and fabrics.

NYC

STANDARD: STAND ALONE SEATING, 9IN ARM

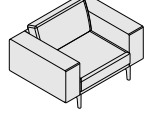
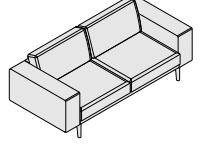
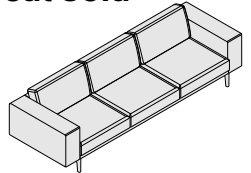
TITLE	SERIES	MODEL	STYLE	ARM	DIMENSIONS	YDG	SQFT	Textile Upholstery Grades										Leather Upholstery Grades								
								COM	COL	COM	A	B	C	D	E	F	G	H	I	J	K	L	M	W	X	Y
Stand Alone Club Chair Standard 9in Arm 	NY	11	2	B29	48W x 34.5D x 30.75H	9	102	4,385	5,103	5,495	5,873	6,264	6,654	7,083	7,512	8,017	8,672	9,453	10,236	11,005	11,787	7,093	7,939	10,246	11,368	13,693
Stand Alone Two-Seat Sofa Standard 9in Arm 	NY	12	2	B29	78W x 34.5D x 30.75H	13	159	6,461	7,475	8,026	8,562	9,114	9,666	10,271	10,876	11,589	12,514	13,619	14,722	15,806	16,912	10,564	11,846	15,116	17,038	20,566
Stand Alone Three-Seat Sofa Standard 9in Arm 	NY	13	2	B29	108W x 34.5D x 30.75H	16	214	8,539	9,892	10,628	11,339	12,076	12,810	13,619	14,425	15,376	16,609	18,081	19,551	20,999	22,470	14,058	15,785	20,184	22,770	27,515

To Order Select Below

1. Series/Model/Style/Arm

NY112B29	NYC Stand Alone, Club Chair Standard, 9in Arm
NY122B29	NYC Stand Alone, Two-Seat Sofa, Standard, 9in Arm
NY132B29	NYC Stand Alone, Three-Seat Sofa, Standard, 9in Arm

2. Upholstery Style

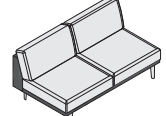
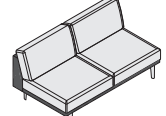
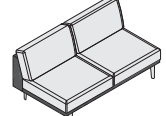
DF	DUAL UPHOLSTERY	Dual upholstery option allows for a second textile to be applied to NYC seats and backs.
		Club Chair Plinth and Arms 6.5 yds Seat and Back 3.5 yds
		Two-Seat Sofa Plinth and Arms 7.5 yds Seats and Backs 6.0 yds
		Three-Seat Sofa Plinth and Arms 9.0 yds Seats and Backs 8.0 yds

3. Leg Choice

C1	ALUMINUM LEGS WITH ADJUSTABLE GLIDES
----	--------------------------------------

4. Leg Finish

BL	BLUE	NK	NICKEL	
BM	BLACK MATTE	NV	NAVY	
BR	BRASS	OR	ORANGE	
BT	BLACK TWILIGHT	PY	PALE YELLOW	
CP	CHAMPAGNE	RD	RED	
DB	DARK BRONZE	RO	RED ORANGE	
DG	DARK GRAY	RR	RUSTY RED	
DP	DUSTY PINK	SB	SOFT BLUE	
FG	FOREST GREEN	SD	SAND	
LG	LIGHT GRAY	TC	TERRACOTTA	
MG	MEADOW GREEN	TP	TAUPE	
MK	MILK	TS	TEXTURED SLATE	
MS	METALLIC SILVER	YL	YELLOW	
	Polished Metal	1-Seat	2-Seat	3-Seat
AL	POLISHED ALUMINUM/CHROME	+223	+223	+297

Chrome rails with polished aluminum legs.

5. Power

Refer to power ordering steps on page 7.

6. Options

WI	WELT CORD ON SEAT	+59	+118	+176
W3	WELT CORD ON SEAT AND BACK	+104	+208	+312
	Sewn Tuft			
T1	TUFTED SEAT	+59	+118	+176
T3	TUFTED SEAT AND BACK	+104	+208	+312
	Button Tuft			
B2	BUTTON TUFTED BACK	+59	+118	+176
	Options			
CT	CONTRASTING THREAD			

Important Option Parameters

Welt cords and sewn tufts can be specified on the same cushions. Button Tufts (backs only) can be combined with tufted seats and welt cords. Contrasting thread is not available with the welt cord option.

7. Upholstery

See general information section for details on textile program and COM/ COL information.

Yardages provided are for non-directional fabrics that are applied railroaded. Directional fabrics may require additional yardage.

When specifying dual upholstery models, the higher of the two grades will determine price.

Tufting will help evenly distribute the wrinkling that will occur with certain leathers and fabrics.

NYC

STANDARD: STAND ALONE BENCHES

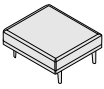
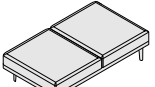
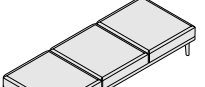
TITLE	SERIES	MODEL	STYLE	DIMENSIONS	COM	COL	Textile Upholstery Grades										Leather Upholstery Grades								
							YDG	SQFT	COM	A	B	C	D	E	F	G	H	I	J	K	L	M	W	X	Y
Stand Alone One-Seat Bench Standard 	NY	01	2	30W x 33.5D x 17.5H	3	40	2,748	3,007	3,148	3,285	3,429	3,570	3,725	3,883	4,065	4,305	4,586	4,871	5,150	5,434	3,800	4,129	4,971	5,461	6,369
Stand Alone Two-Seat Bench Standard 	NY	02	2	60W x 33.5D x 17.5H	5	74	3,357	3,793	4,028	4,257	4,494	4,730	4,990	5,248	5,553	5,950	6,424	6,899	7,363	7,836	5,299	5,903	7,452	8,360	10,030
Stand Alone Three-Seat Bench Standard 	NY	03	2	90W x 33.5D x 17.5H	7.5	100	4,881	5,492	5,823	6,143	6,474	6,805	7,168	7,532	7,960	8,513	9,176	9,840	10,491	11,154	7,707	8,588	10,840	12,163	14,589

To Order Select Below

1. Series/Model/Style

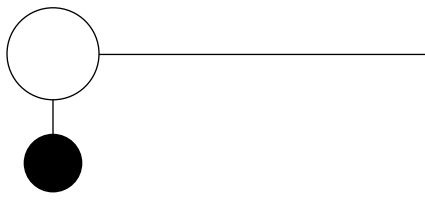

NY012
NYC Stand Alone, One-Seat Bench, Standard

NY022
NYC Stand Alone, Two-Seat Bench, Standard

NY032
NYC Stand-Alone, Three-Seat Bench, Standard

2. Upholstery Style



DF DUAL UPHOLSTERY
 Dual upholstery option allows for a second textile to be applied to NYC seats and backs.

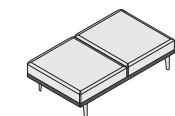

One-Seat Stand Alone Bench
 Plinth 1.5 yds
 Seat 2.5 yds

Two-Seat Stand Alone Bench
 Plinth 2.0 yds
 Seats 4.0 yds

Three-Seat Stand Alone Bench
 Plinth 2.0 yds
 Seats 6.0 yds

3. Leg Choice

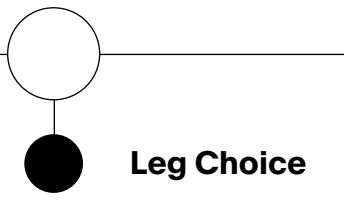

C1 ALUMINUM LEGS WITH ADJUSTABLE GLIDES

4. Leg Finish



Standard Powder Coat

BL	BLUE
BM	BLACK MATTE
BR	BRASS
BT	BLACK TWILIGHT
CP	CHAMPAGNE
DB	DARK BRONZE
DG	DARK GRAY
DP	DUSTY PINK
FG	FOREST GREEN
LG	LIGHT GRAY
MG	MEADOW GREEN
MK	MILK
MS	METALLIC SILVER

Polished Metal

AL	POLISHED ALUMINUM/CHROME	+223	+223	+297
----	--------------------------	-------------	-------------	-------------

Chrome rails with polished aluminum legs.

5. Power

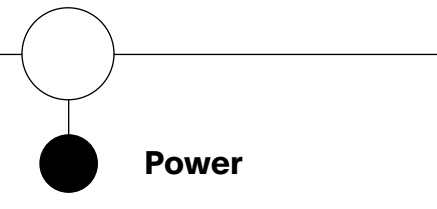

Power
 Refer to power ordering steps on [page 7](#).

6. Options

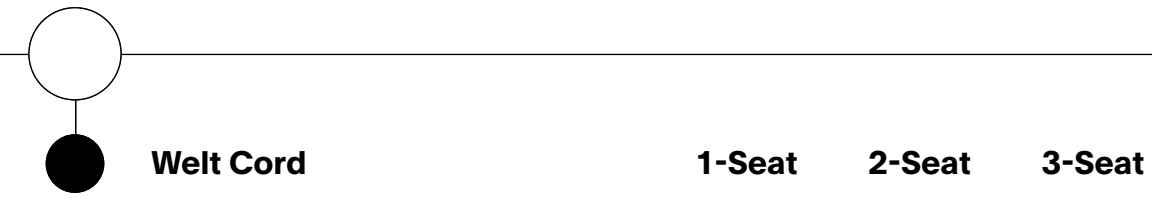

Welt Cord

WI	WELT CORD ON SEAT	+59	+118	+176
----	-------------------	------------	-------------	-------------

Sewn Tuft

T1	TUFTED SEAT	+59	+118	+176
----	-------------	------------	-------------	-------------

Options

CT	CONTRASTING THREAD			
----	--------------------	--	--	--

Important Option Parameters
 Welt cords and sewn tufts can be specified on the same cushions. Contrasting thread is not available with the welt cord option.

7. Upholstery

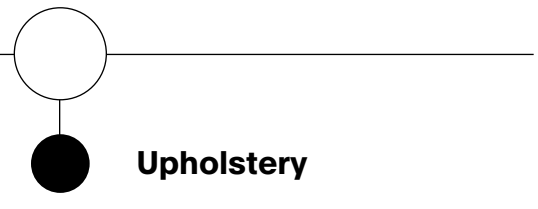

Upholstery
 See general information section for details on textile program and COM/ COL information.

Yardages provided are for non-directional fabrics that are applied railroaded. Directional fabrics may require additional yardage.

When specifying dual upholstery models, the higher of the two grades will determine price.

Tufting will help evenly distribute the wrinkling that will occur with certain leathers and fabrics.

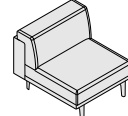
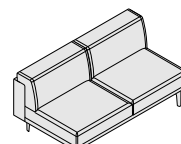
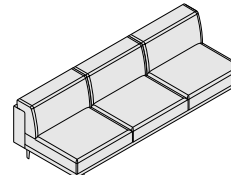

NYC

WRAP-OVER: MODULAR SEATING

TITLE	SERIES	MODEL	STYLE	DIMENSIONS	COM	COL	Textile Upholstery Grades										Leather Upholstery Grades								
							YDG	SQFT	COM	A	B	COL	C	D	E	F	G	H	I	J	K	L	M	W	X
Modular One-Seat Unit Wrap-Over																									
	NY	11	1	30W x 34.5D x 29.5H	4.5	70	3,411	3,767	3,960	4,148	4,341	4,533	4,746	4,957	5,206	5,529	5,916	6,304	6,681	7,070	5,206	5,767	7,197	8,036	9,580
Modular Two-Seat Unit Wrap-Over																									
	NY	12	1	60W x 34.5D x 29.5H	8.5	132	5,489	6,164	6,533	6,890	7,257	7,625	8,028	8,433	8,905	9,525	10,259	10,996	11,720	12,456	8,884	9,947	12,653	14,245	17,165
Modular Three-Seat Unit Wrap-Over																									
	NY	13	1	90W x 34.5D x 29.5H	13	194	7,565	8,581	9,131	9,666	10,218	10,771	11,375	11,981	12,691	13,619	14,723	15,825	16,912	18,016	12,557	14,118	18,098	20,437	24,725

To Order Select Below

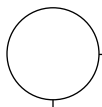
1. Series/Model/Style

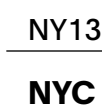
	NY111	NYC Modular, One-Seat Unit, Wrap-Over
	NY121	NYC Modular, Two-Seat Unit, Wrap-Over
	NY131	NYC Modular, Three-Seat Unit, Wrap-Over

2. Upholstery Style

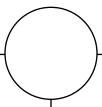
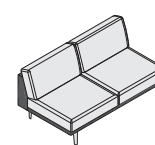
	Upholstery Style
DF	DUAL UPHOLSTERY
	Dual upholstery option allows for a second textile to be applied to NYC seats and backs.
	One-Seat Plinth
	Seat and Back 2.0 yds
	3.5 yds
	Two-Seat Plinth
	Seats and Backs 3.0 yds
	6.0 yds
	Three-Seat Plinth
	Seats and Backs 4.0 yds
	9.0 yds

3. Leg Choice

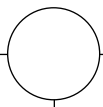
	Leg Choice
C1	ALUMINUM LEGS WITH ADJUSTABLE GLIDES

4. Leg Finish

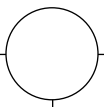
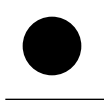

	Standard Powder Coat			
BL	BLUE			
BM	BLACK MATTE			
BR	BRASS			
BT	BLACK TWILIGHT			
CP	CHAMPAGNE			
DB	DARK BRONZE			
DG	DARK GRAY			
DP	DUSTY PINK			
FG	FOREST GREEN			
LG	LIGHT GRAY			
MG	MEADOW GREEN			
MK	MILK			
MS	METALLIC SILVER			
	Polished Metal			
AL	POLISHED ALUMINUM/CHROME	1-Seat +223	2-Seat +223	3-Seat +297

Chrome rails with polished aluminum legs.

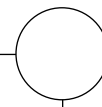
5. Power

	Power
	Refer to power ordering steps on page 7 .

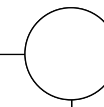
6. Options

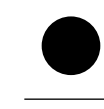
	Welt Cord			
WI	WELT CORD ON SEAT	+59	+118	+176
W3	WELT CORD ON SEAT AND BACK	+104	+208	+312
	Sewn Tuft			
T1	TUFTED SEAT	+59	+118	+176
T3	TUFTED SEAT AND BACK	+104	+208	+312
	Options			
CT	CONTRASTING THREAD			

Important Option Parameters

Welt cords and sewn tufts can be specified on the same cushions. Contrasting thread is not available with the welt cord option.

7. Upholstery

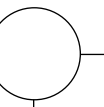
	Upholstery
	See general information section for details on textile program and COM/ COL information.
	Yardages provided are for non-directional fabrics that are applied railroaded. Directional fabrics may require additional yardage.
	When specifying dual upholstery models, the higher of the two grades will determine price.
	Tufting will help evenly distribute the wrinkling that will occur with certain leathers and fabrics.

NYC

WRAP-OVER: MODULAR CORNERS

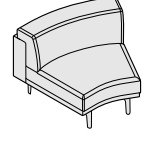
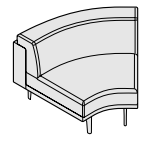
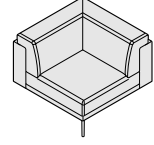
TITLE	SERIES	MODEL	STYLE	DIMENSIONS	COM	COL	Textile Upholstery Grades										Leather Upholstery Grades								
							YDG	SQFT	COM	A	B	COL	C	D	E	F	G	H	I	J	K	L	M	W	X
Modular 135 Degree Corner Wrap-Over 	NY	14	1	42W x 34.5D x 29.5H	6	75	3,856	4,364	4,639	4,909	5,185	5,459	5,761	6,065	6,421	6,884	7,437	7,988	8,531	9,083	5,814	6,424	7,984	8,901	10,584
Modular 150 Degree Corner Wrap-Over 	NY	15	1	40.38W x 34.5D x 29.5H	6	75	3,856	4,364	4,639	4,909	5,185	5,459	5,761	6,065	6,421	6,884	7,437	7,988	8,531	9,083	5,814	6,424	7,984	8,901	10,584
Modular 90 Degree Corner Wrap-Over 	NY	16	1	47.88W x 34.5D x 29.5H	7	99	4,153	4,746	5,066	5,378	5,702	6,023	6,376	6,729	7,144	7,684	8,329	8,973	9,606	10,249	6,711	7,509	9,549	10,746	12,943

To Order Select Below

1. Series/Model/Style

- NY141
NYC Modular, 135° Corner, Wrap-Over
- NY151
NYC Modular, 150° Corner, Wrap-Over
- NY161
NYC Modular, 90° Corner, Wrap-Over

2. Upholstery Style

- Upholstery Style**
DF DUAL UPHOLSTERY
Dual upholstery option allows for a second textile to be applied to NYC seats and backs.
- 135° Corner**
Plinth 3.0 yds
Seat and Back 4.0 yds
- 150° Corner**
Plinth 3.0 yds
Seat and Back 4.0 yds
- 90° Corner**
Plinth 3.0 yds
Seat and Backs 4.0 yds

3. Leg Choice

- Leg Choice**
C1 ALUMINUM LEGS WITH ADJUSTABLE GLIDES

4. Leg Finish

- Standard Powder Coat**
 - BL BLUE
 - BM BLACK MATTE
 - BR BRASS
 - BT BLACK TWILIGHT
 - CP CHAMPAGNE
 - DB DARK BRONZE
 - DG DARK GRAY
 - DP DUSTY PINK
 - FG FOREST GREEN
 - LG LIGHT GRAY
 - MG MEADOW GREEN
 - MK MILK
 - MS METALLIC SILVER
- Polished Metal**
 - AL POLISHED ALUMINUM/CHROME **+223**

Chrome rails with polished aluminum legs.

5. Power

- Power**
Refer to power ordering steps on [page 7](#).

6. Options

- Welt Cord**
 - WI WELT CORD ON SEAT **+59**
 - W3 WELT CORD ON SEAT AND BACK **+147**
- Sewn Tuft**
 - T1 TUFTED SEAT **+59**
 - T3 TUFTED SEAT AND BACK **+147**
- Options**
 - CT CONTRASTING THREAD

Important Option Parameters

Welt cords and sewn tufts can be specified on the same cushions. Contrasting thread is not available with the welt cord option.

7. Upholstery

- Upholstery**
See [general information section](#) for details on textile program and COM/COL information.

Yardages provided are for non-directional fabrics that are applied railroaded. Directional fabrics may require additional yardage.

When specifying dual upholstery models, the higher of the two grades will determine price.

Tufting will help evenly distribute the wrinkling that will occur with certain leathers and fabrics.

NYC

WRAP-OVER: MODULAR IN-LINE BENCHES

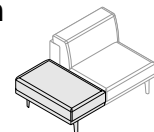
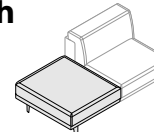
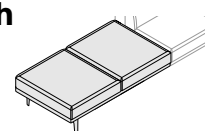
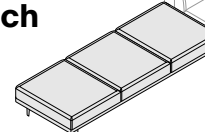
TITLE	SERIES	MODEL	STYLE	DIMENSIONS	COM	COL	Textile Upholstery Grades										Leather Upholstery Grades								
							YDG	SQFT	COM	A	B	C	D	E	F	G	H	I	J	K	L	M	W	X	Y
Modular 2/3-Seat In-line Bench Wrap-Over 	NY	07	1	20W x 34.5D x 17.5H	2.5	30	1,831	2,004	2,099	2,191	2,285	2,381	2,484	2,589	2,709	2,868	3,058	3,247	3,432	3,623	2,636	2,889	3,529	3,908	4,597
Modular One-Seat In-line Bench Wrap-Over 	NY	04	1	30W x 34.5D x 17.5H	3	40	2,137	2,398	2,539	2,676	2,819	2,961	3,114	3,272	3,455	3,694	3,975	4,259	4,539	4,824	3,190	3,518	4,361	4,851	5,758
Modular Two-Seat In-line Bench Wrap-Over 	NY	05	1	60W x 34.5D x 17.5H	5	74	3,357	3,793	4,028	4,257	4,494	4,730	4,990	5,248	5,553	5,950	6,424	6,899	7,363	7,836	5,299	5,903	7,452	8,360	10,030
Modular Three-Seat In-line Bench Wrap-Over 	NY	06	1	90W x 34.5D x 17.5H	7.5	99	4,881	5,492	5,823	6,143	6,474	6,805	7,168	7,532	7,960	8,513	9,176	9,840	10,491	11,154	7,707	8,588	10,840	12,163	14,589

To Order Select Below

1. Series/Model/Style

NY071	NYC Modular, 2/3-Seat In-line Bench, Wrap-Over
NY041	NYC Modular, One-Seat In-line Bench, Wrap-Over
NY051	NYC Modular, Two-Seat In-line Bench, Wrap-Over
NY061	NYC Modular, Three-Seat In-line Bench, Wrap-Over

2. Upholstery Style

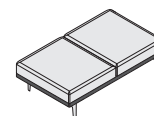
DF	DUAL UPHOLSTERY
Dual upholstery option allows for a second textile to be applied to NYC seats and backs.	
	2/3-Seat In-Line Bench
Plinth	1.5 yds
Seat	2.0 yds
	One-Seat In-Line Bench
Plinth	1.5 yds
Seat	2.5 yds
	Two-Seat In-Line Bench
Plinth	2.0 yds
Seats	4.0 yds
	Three-Seat In-Line Bench
Plinth	2.0 yds
Seats	6.0 yds

3. Leg Choice

C1	ALUMINUM LEGS WITH ADJUSTABLE GLIDES
----	---

4. Leg Finish

BL	BLUE	NK	NICKEL	
BM	BLACK MATTE	NV	NAVY	
BR	BRASS	OR	ORANGE	
BT	BLACK TWILIGHT	PY	PALE YELLOW	
CP	CHAMPAGNE	RD	RED	
DB	DARK BRONZE	RO	RED ORANGE	
DG	DARK GRAY	RR	RUSTY RED	
DP	DUSTY PINK	SB	SOFT BLUE	
FG	FOREST GREEN	SD	SAND	
LG	LIGHT GRAY	TC	TERRACOTTA	
MG	MEADOW GREEN	TP	TAUPE	
MK	MILK	TS	TEXTURED SLATE	
MS	METALLIC SILVER	YL	YELLOW	
	Polished Metal	2/3-Seat 1-Seat	2-Seat	3-Seat
AL	POLISHED ALUMINUM/CHROME	+223	+223	+297

Chrome rails with polished aluminum legs.

5. Power

Power
Refer to power ordering steps on [page 7](#).

6. Options

WI	WELT CORD ON SEAT	2/3-Seat 1-Seat	2-Seat	3-Seat
		+59	+118	+176
	Sewn Tuft			
T1	TUFTED SEAT	+59	+118	+176
	Options			
CT	CONTRASTING THREAD			

Important Option Parameters
Welt cords and sewn tufts can be specified on the same cushions. Contrasting thread is not available with the welt cord option.

7. Upholstery

Upholstery
See general information section for details on textile program and COM/ COL information.

Yardages provided are for non-directional fabrics that are applied railroaded. Directional fabrics may require additional yardage.

When specifying dual upholstery models, the higher of the two grades will determine price.

Tufting will help evenly distribute the wrinkling that will occur with certain leathers and fabrics.

NYC

WRAP-OVERD: STAND ALONE SEATING, 4IN ARM

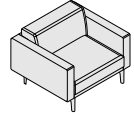
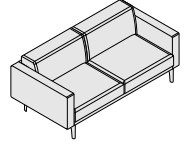
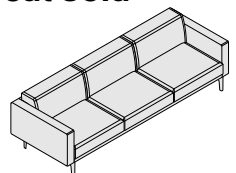
TITLE	SERIES	MODEL	STYLE	ARM	DIMENSIONS	COM YDG	COL SQFT	Textile Upholstery Grades										Leather Upholstery Grades								
								COM	A	B	C	D	E	F	G	H	I	J	K	L	M	W	X	Y	E1	E2
Stand Alone Club Chair Wrap-Over 4in Arm 	NY	11	1	B24	38W x 34.5D x 29.5H	7	108	4,385	4,934	5,234	5,523	5,822	6,120	6,448	6,776	7,162	7,664	8,260	8,858	9,449	10,045	7,159	8,025	10,238	11,538	13,921
Stand Alone Two-Seat Sofa Wrap-Over 4in Arm 	NY	12	1	B24	68W x 34.5D x 29.5H	11	170	6,461	7,308	7,767	8,211	8,672	9,131	9,636	10,140	10,733	11,506	12,426	13,344	14,250	15,169	10,840	12,206	15,694	17,747	21,507
Stand Alone Three-Seat Sofa Wrap-Over 4in Arm 	NY	13	1	B24	98W x 34.5D x 29.5H	15	232	8,539	9,807	10,498	11,165	11,855	12,544	13,300	14,057	14,947	16,103	17,483	18,864	20,222	21,600	14,511	16,380	21,137	23,938	29,071

To Order Select Below

1. Series/Model/Style/Arm

- NY111B24
NYC Stand Alone, Club Chair Wrap-Over, 4in Arm
- NY121B24
NYC Stand Alone, Two-Seat Sofa, Wrap-Over, 4in Arm
- NY131B24
NYC Stand Alone, Three-Seat Sofa, Wrap-Over, 4in Arm

2. Upholstery Style

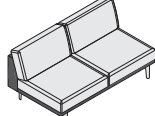
- DF DUAL UPHOLSTERY
Dual upholstery option allows for a second textile to be applied to NYC seats and backs.
- 
Club Chair
Plinth and Arms 4.5 yds
Seat and Back 3.5 yds
- Two-Seat Sofa**
Plinth and Arms 5.5 yds
Seats and Backs 6.0 yds
- Three-Seat Sofa**
Plinth and Arms 6.5 yds
Seats and Backs 9.0 yds

3. Leg Choice

- C1 ALUMINUM LEGS WITH ADJUSTABLE GLIDES

4. Leg Finish

- Standard Powder Coat**
 - BL BLUE
 - BM BLACK MATTE
 - BR BRASS
 - BT BLACK TWILIGHT
 - CP CHAMPAGNE
 - DB DARK BRONZE
 - DG DARK GRAY
 - DP DUSTY PINK
 - FG FOREST GREEN
 - LG LIGHT GRAY
 - MG MEADOW GREEN
 - MK MILK
 - MS METALLIC SILVER
- Polished Metal**

	1-Seat	2-Seat	3-Seat
AL POLISHED ALUMINUM/CHROME	+223	+223	+297

Chrome rails with polished aluminum legs.

5. Power

- Power**
Refer to power ordering steps on page 7.

6. Options

- Welt Cord**

	1-Seat	2-Seat	3-Seat
WI WELT CORD ON SEAT	+59	+118	+176
W3 WELT CORD ON SEAT AND BACK	+104	+208	+312
- Sewn Tuft**

	1-Seat	2-Seat	3-Seat
T1 TUFTED SEAT	+59	+118	+176
T3 TUFTED SEAT AND BACK	+104	+208	+312
- Options**

CT CONTRASTING THREAD			
-----------------------	--	--	--

Important Option Parameters

Welt cords and sewn tufts can be specified on the same cushions. Contrasting thread is not available with the welt cord option.

7. Upholstery

- Upholstery**
See general information section for details on textile program and COM/ COL information.
- Yardages provided are for non-directional fabrics that are applied railroaded. Directional fabrics may require additional yardage.
- When specifying dual upholstery models, the higher of the two grades will determine price.
- Tufting will help evenly distribute the wrinkling that will occur with certain leathers and fabrics.

NYC

STANDARD: STAND ALONE SEATING, 6IN ARM

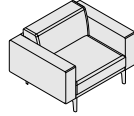
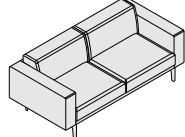
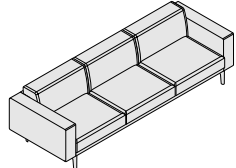
TITLE	SERIES	MODEL	STYLE	ARM	DIMENSIONS	COM YDG	COL SQFT	Textile Upholstery Grades											Leather Upholstery Grades							
								COM	A	B	C	D	E	F	G	H	I	J	K	L	M	W	X	Y	E1	E2
Stand Alone Club Chair Wrap-Over 6in Arm 	NY	11	1	B26	42W x 34.5D x 29.5H	7	108	4,385	4,934	5,234	5,523	5,822	6,120	6,448	6,776	7,162	7,664	8,260	8,858	9,449	10,045	7,159	8,025	10,238	11,538	13,921
Stand Alone Two-Seat Sofa Wrap-Over 6in Arm 	NY	12	1	B26	72W x 34.5D x 29.5H	11	170	6,461	7,308	7,767	8,211	8,672	9,131	9,636	10,140	10,733	11,506	12,426	13,344	14,250	15,169	10,840	12,206	15,694	17,747	21,507
Stand Alone Three-Seat Sofa Wrap-Over 6in Arm 	NY	13	1	B26	102W x 34.5D x 29.5H	15	232	8,539	9,807	10,498	11,165	11,855	12,544	13,300	14,057	14,947	16,103	17,483	18,864	20,222	21,600	14,511	16,380	21,137	23,938	29,071

To Order Select Below

1. Series/Model/Style/Arm

- NY11B26
NYC Stand Alone, Club Chair Wrap-Over, 6in Arm
- NY12B26
NYC Stand Alone, Two-Seat Sofa, Wrap-Over, 6in Arm
- NY13B26
NYC Stand Alone, Three-Seat Sofa, Wrap-Over, 6in Arm

2. Upholstery Style

- Upholstery Style**
DF DUAL UPHOLSTERY
Dual upholstery option allows for a second textile to be applied to NYC seats and backs.
- Club Chair**
Plinth and Arms 4.5 yds
Seat and Back 3.5 yds
- Two-Seat Sofa**
Plinth and Arms 5.5 yds
Seats and Backs 6.0 yds
- Three-Seat Sofa**
Plinth and Arms 6.5 yds
Seats and Backs 9.0 yds

3. Leg Choice

- Leg Choice**
C1 ALUMINUM LEGS WITH ADJUSTABLE GLIDES

4. Leg Finish

- Standard Powder Coat**

BL	BLUE	NK	NICKEL
BM	BLACK MATTE	NV	NAVY
BR	BRASS	OR	ORANGE
BT	BLACK TWILIGHT	PY	PALE YELLOW
CP	CHAMPAGNE	RD	RED
DB	DARK BRONZE	RO	RED ORANGE
DG	DARK GRAY	RR	RUSTY RED
DP	DUSTY PINK	SB	SOFT BLUE
FG	FOREST GREEN	SD	SAND
LG	LIGHT GRAY	TC	TERRACOTTA
MG	MEADOW GREEN	TP	TAUPE
MK	MILK	TS	TEXTURED SLATE
MS	METALLIC SILVER	YL	YELLOW
- Polished Metal**

	1-Seat	2-Seat	3-Seat
AL POLISHED ALUMINUM/CHROME	+223	+223	+297

Chrome rails with polished aluminum legs.

5. Power

- Power**
Refer to power ordering steps on page 7.

6. Options

- Welt Cord**

	1-Seat	2-Seat	3-Seat
WI WELT CORD ON SEAT	+59	+118	+176
W3 WELT CORD ON SEAT AND BACK	+104	+208	+312
- Sewn Tuft**

	1-Seat	2-Seat	3-Seat
T1 TUFTED SEAT	+59	+118	+176
T3 TUFTED SEAT AND BACK	+104	+208	+312
- Options**
CT CONTRASTING THREAD

Important Option Parameters

Welt cords and sewn tufts can be specified on the same cushions. Contrasting thread is not available with the welt cord option.

7. Upholstery

- Upholstery**
See general information section for details on textile program and COM/ COL information.
Yardages provided are for non-directional fabrics that are applied railroaded. Directional fabrics may require additional yardage.
When specifying dual upholstery models, the higher of the two grades will determine price.
Tufting will help evenly distribute the wrinkling that will occur with certain leathers and fabrics.

NYC

WRAP-OVER: STAND ALONE SEATING, 9IN ARM

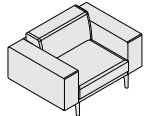
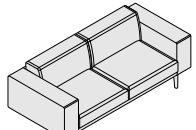
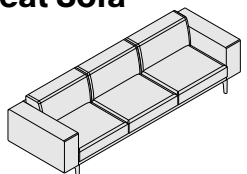
TITLE	SERIES	MODEL	STYLE	ARM	DIMENSIONS	COM YDG	COL SQFT	Textile Upholstery Grades										Leather Upholstery Grades								
								COM	A	B	C	D	E	F	G	H	I	J	K	L	M	W	X	Y	E1	E2
Stand Alone Club Chair Wrap-Over 9in Arm 	NY	11	1	B29	48W x 34.5D x 29.5H	9	112	4,385	5,103	5,495	5,873	6,264	6,654	7,083	7,512	8,017	8,672	9,453	10,236	11,005	11,787	7,274	8,180	10,480	11,835	14,318
Stand Alone Two-Seat Sofa Wrap-Over 9in Arm 	NY	12	1	B29	78W x 34.5D x 29.5H	13	174	6,461	7,475	8,026	8,562	9,114	9,666	10,271	10,876	11,589	12,514	13,619	14,722	15,806	16,912	10,954	12,359	15,937	18,044	21,904
Stand Alone Three-Seat Sofa Wrap-Over 9in Arm 	NY	13	1	B29	108W x 34.5D x 29.5H	17	236	8,539	9,977	10,759	11,513	12,298	13,079	13,936	14,792	15,801	17,112	18,677	20,240	21,778	23,342	14,625	16,530	21,380	24,235	29,468

To Order Select Below

1. Series/Model/Style/Arm

- NY11B29
NYC Stand Alone, Club Chair Wrap-Over, 9in Arm
- NY12B29
NYC Stand Alone, Two-Seat Sofa, Wrap-Over, 9in Arm
- NY13B29
NYC Stand Alone, Three-Seat Sofa, Wrap-Over, 9in Arm

2. Upholstery Style

- Upholstery Style**
DF DUAL UPHOLSTERY
Dual upholstery option allows for a second textile to be applied to NYC seats and backs.
- Club Chair**
Plinth and Arms 6.5 yds
Seat and Back 3.5 yds
- Two-Seat Sofa**
Plinth and Arms 7.5 yds
Seats and Backs 6.0 yds
- Three-Seat Sofa**
Plinth and Arms 9.0 yds
Seats and Backs 8.0 yds

3. Leg Choice

- Leg Choice**
C1 ALUMINUM LEGS WITH ADJUSTABLE GLIDES

4. Leg Finish

- Standard Powder Coat**

BL	BLUE	NK	NICKEL
BM	BLACK MATTE	NV	NAVY
BR	BRASS	OR	ORANGE
BT	BLACK TWILIGHT	PY	PALE YELLOW
CP	CHAMPAGNE	RD	RED
DB	DARK BRONZE	RO	RED ORANGE
DG	DARK GRAY	RR	RUSTY RED
DP	DUSTY PINK	SB	SOFT BLUE
FG	FOREST GREEN	SD	SAND
LG	LIGHT GRAY	TC	TERRACOTTA
MG	MEADOW GREEN	TP	TAUPE
MK	MILK	TS	TEXTURED SLATE
MS	METALLIC SILVER	YL	YELLOW
- Polished Metal**

	1-Seat	2-Seat	3-Seat
AL POLISHED ALUMINUM/CHROME	+223	+223	+297

Chrome rails with polished aluminum legs.

5. Power

- Power**
Refer to power ordering steps on page 7.

6. Options

- Welt Cord**

	1-Seat	2-Seat	3-Seat
WI WELT CORD ON SEAT	+59	+118	+176
W3 WELT CORD ON SEAT AND BACK	+104	+208	+312
- Sewn Tuft**

	1-Seat	2-Seat	3-Seat
T1 TUFTED SEAT	+59	+118	+176
T3 TUFTED SEAT AND BACK	+104	+208	+312
- Options**
CT CONTRASTING THREAD

Important Option Parameters

Welt cords and sewn tufts can be specified on the same cushions. Contrasting thread is not available with the welt cord option.

7. Upholstery

- Upholstery**
See general information section for details on textile program and COM/ COL information.
Yardages provided are for non-directional fabrics that are applied railroaded. Directional fabrics may require additional yardage.
When specifying dual upholstery models, the higher of the two grades will determine price.
Tufting will help evenly distribute the wrinkling that will occur with certain leathers and fabrics.

NYC

WRAP-OVER: STAND ALONE BENCHES

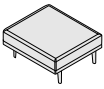
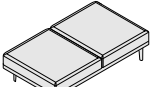
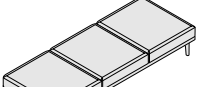
TITLE	SERIES	MODEL	STYLE	DIMENSIONS	COM	COL	Textile Upholstery Grades										Leather Upholstery Grades								
							YDG	SQFT	COM	A	B	C	D	E	F	G	H	I	J	K	L	M	W	X	Y
Stand Alone One-Seat Bench Wrap-Over 	NY	01	1	30W x 33.5D x 17.5H	3	40	2,748	3,007	3,148	3,285	3,429	3,570	3,725	3,883	4,065	4,305	4,586	4,871	5,150	5,434	3,800	4,129	4,971	5,461	6,369
Stand Alone Two-Seat Bench Wrap-Over 	NY	02	1	60W x 33.5D x 17.5H	5.5	74	3,357	3,793	4,028	4,257	4,494	4,730	4,990	5,248	5,553	5,950	6,424	6,899	7,363	7,836	5,299	5,903	7,452	8,360	10,030
Stand Alone Three-Seat Bench Wrap-Over 	NY	03	1	90W x 33.5D x 17.5H	7.5	99	4,881	5,492	5,823	6,143	6,474	6,805	7,168	7,532	7,960	8,513	9,176	9,840	10,491	11,154	7,707	8,588	10,840	12,163	14,589

To Order Select Below

1. Series/Model/Style

- NY011
NYC Stand Alone, One-Seat Bench, Wrap-Over
- NY021
NYC Stand Alone, Two-Seat Bench, Wrap-Over
- NY031
NYC Stand-Alone, Three-Seat Bench, Wrap-Over

2. Upholstery Style

- Upholstery Style**
DF DUAL UPHOLSTERY

Dual upholstery option allows for a second textile to be applied to NYC seats and backs.

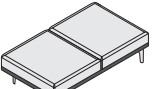
- One-Seat Stand Alone Bench**
Plinth 1.5 yds
Seat 2.5 yds
- Two-Seat Stand Alone Bench**
Plinth 2.0 yds
Seats 4.0 yds
- Three-Seat Stand Alone Bench**
Plinth 2.0 yds
Seats 6.0 yds

3. Leg Choice

- Leg Choice**
C1 ALUMINUM LEGS WITH ADJUSTABLE GLIDES

4. Leg Finish

- Standard Powder Coat**

BL	BLUE	NK	NICKEL
BM	BLACK MATTE	NV	NAVY
BR	BRASS	OR	ORANGE
BT	BLACK TWILIGHT	PY	PALE YELLOW
CP	CHAMPAGNE	RD	RED
DB	DARK BRONZE	RO	RED ORANGE
DG	DARK GRAY	RR	RUSTY RED
DP	DUSTY PINK	SB	SOFT BLUE
FG	FOREST GREEN	SD	SAND
LG	LIGHT GRAY	TC	TERRACOTTA
MG	MEADOW GREEN	TP	TAUPE
MK	MILK	TS	TEXTURED SLATE
MS	METALLIC SILVER	YL	YELLOW
- Polished Metal**

	1-Seat	2-Seat	3-Seat	
AL	POLISHED ALUMINUM/CHROME	+223	+223	+297

Chrome rails with polished aluminum legs.

5. Power

- Power**
Refer to power ordering steps on [page 7](#).

6. Options

- Welt Cord**

WI	WELT CORD ON SEAT	+59	+118	+176
----	-------------------	------------	-------------	-------------
 - Sewn Tuft**

T1	TUFTED SEAT	+59	+118	+176
----	-------------	------------	-------------	-------------
 - Options**

CT	CONTRASTING THREAD			
----	--------------------	--	--	--
- Important Option Parameters**
Welt cords and sewn tufts can be specified on the same cushions. Contrasting thread is not available with the welt cord option.

7. Upholstery

- Upholstery**
See [general information section](#) for details on textile program and COM/ COL information.

Yardages provided are for non-directional fabrics that are applied railroaded. Directional fabrics may require additional yardage.

When specifying dual upholstery models, the higher of the two grades will determine price.

Tufting will help evenly distribute the wrinkling that will occur with certain leathers and fabrics.

NYC

RELAXED: MODULAR SEATING

TITLE	SERIES	MODEL	STYLE	DIMENSIONS	COM	COL	Textile Upholstery Grades										Leather Upholstery Grades								
							YDG	SQFT	COM	A	B	C	D	E	F	G	H	I	J	K	L	M	W	X	Y
Modular One Seat Unit Relaxed	NY	11	3	30W x 34.5D x 29.5H	4.5	62	3,709	4,065	4,257	4,445	4,637	4,830	5,044	5,253	5,502	5,828	6,212	6,600	6,978	7,367	5,321	5,824	7,110	7,865	9,251
Modular Two Seat Unit Relaxed	NY	12	3	60W x 34.5D x 29.5H	8	117	6,082	6,759	7,125	7,483	7,851	8,217	8,623	9,027	9,500	10,118	10,853	11,590	12,312	13,049	9,089	10,030	12,424	13,834	16,418
Modular Three Seat Unit Relaxed	NY	13	3	90W x 34.5D x 29.5H	12	171	8,457	9,471	10,022	10,556	11,109	11,660	12,264	12,871	13,581	14,509	15,611	16,714	17,802	18,906	12,881	14,263	17,789	19,862	23,664

To Order Select Below

1. Series/Model/Style

NY113	NYC Modular, One-Seat Unit, Relaxed
NY123	NYC Modular, Two-Seat Unit, Relaxed
NY133	NYC Modular, Three-Seat Unit, Relaxed

2. Upholstery Style

DF	DUAL UPHOLSTERY	Dual upholstery option allows for a second textile to be applied to NYC seats and backs.
	One-Seat Plinth	2.0 yds
	Seat and Back	3.5 yds
	Two-Seat Plinth	3.0 yds
	Seats and Backs	6.0 yds
	Three-Seat Plinth	5.0 yds
	Seats and Backs	8.0 yds

3. Leg Choice

C1	ALUMINUM LEGS WITH ADJUSTABLE GLIDES
----	---

4. Leg Finish

BL	BLUE		
BM	BLACK MATTE		
BR	BRASS		
BT	BLACK TWILIGHT		
CP	CHAMPAGNE		
DB	DARK BRONZE		
DG	DARK GRAY		
DP	DUSTY PINK		
FG	FOREST GREEN		
LG	LIGHT GRAY		
MG	MEADOW GREEN		
MK	MILK		
MS	METALLIC SILVER		
	Polished Metal	1-Seat	2-Seat
AL	POLISHED ALUMINUM/CHROME	+223	+223
		+297	

Chrome rails with polished aluminum legs.

5. Power

Power
Refer to power ordering steps on [page 7](#).

6. Options

WI	WELT CORD ON SEAT	+59	+118	+176
W3	WELT CORD ON SEAT AND BACK	+104	+208	+312
	Options			
CT	CONTRASTING THREAD			

Important Option Parameters
Contrasting thread is not available with the welt cord option.

7. Upholstery

Upholstery
See general information section for details on textile program and COM/ COL information.

Yardages provided are for non-directional fabrics that are applied railroaded. Directional fabrics may require additional yardage.

When specifying dual upholstery models, the higher of the two grades will determine price.

Tufting will help evenly distribute the wrinkling that will occur with certain leathers and fabrics.

NYC

RELAXED: MODULAR CORNERS

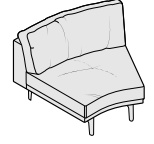
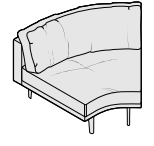
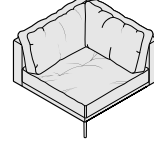
TITLE	SERIES	MODEL	STYLE	DIMENSIONS	COM	COL	Textile Upholstery Grades										Leather Upholstery Grades								
							YDG	SQFT	COM	A	B	COL	C	D	E	F	G	H	I	J	K	L	M	W	X
Modular 135 Degree Corner Relaxed 	NY	14	3	42W x 34.5D x 29.5H	6	65	4,304	4,808	5,085	5,354	5,629	5,903	6,207	6,509	6,865	7,328	7,881	8,433	8,975	9,527	5,986	6,510	7,854	8,642	10,088
Modular 150 Degree Corner Relaxed 	NY	15	3	40.38W x 34.5D x 29.5H	6	65	4,304	4,808	5,085	5,354	5,629	5,903	6,207	6,509	6,865	7,328	7,881	8,433	8,975	9,527	5,986	6,510	7,854	8,642	10,088
Modular 90 Degree Corner Relaxed 	NY	16	3	47.88W x 34.5D x 29.5H	7	89	4,597	5,125	5,409	5,684	5,969	6,254	6,568	6,880	7,247	7,726	8,296	8,867	9,427	9,998	6,905	7,628	9,469	10,549	12,532

To Order Select Below

1. Series/Model/Style

- NY143
NYC Modular, 135° Corner, Relaxed
- NY153
NYC Modular, 150° Corner, Relaxed
- NY163
NYC Modular, 90° Corner, Relaxed

2. Upholstery Style

- Upholstery Style**
DF DUAL UPHOLSTERY
Dual upholstery option allows for a second textile to be applied to NYC seats and backs.
- 135° Corner**
Plinth 3.0 yds
Seat and Back 4.0 yds
- 150° Corner**
Plinth 3.0 yds
Seat and Back 4.0 yds
- 90° Corner**
Plinth 3.0 yds
Seat and Backs 4.0 yds

3. Leg Choice

- Leg Choice**
C1 ALUMINUM LEGS WITH ADJUSTABLE GLIDES

4. Leg Finish

- Standard Powder Coat**
 - BL BLUE
 - BM BLACK MATTE
 - BR BRASS
 - BT BLACK TWILIGHT
 - CP CHAMPAGNE
 - DB DARK BRONZE
 - DG DARK GRAY
 - DP DUSTY PINK
 - FG FOREST GREEN
 - LG LIGHT GRAY
 - MG MEADOW GREEN
 - MK MILK
 - MS METALLIC SILVER
- Polished Metal**
 - AL POLISHED ALUMINUM/CHROME +223

Chrome rails with polished aluminum legs.

5. Power

- Power**
Refer to power ordering steps on [page 7](#).

6. Options

- Welt Cord**
 - WI WELT CORD ON SEAT +59
 - W3 WELT CORD ON SEAT AND BACK +147
 - Options**
 - CT CONTRASTING THREAD
- Important Option Parameters**
Contrasting thread is not available with the welt cord option.

7. Upholstery

- Upholstery**
See [general information section](#) for details on textile program and COM/COL information.



Yardages provided are for non-directional fabrics that are applied railroaded. Directional fabrics may require additional yardage.

When specifying dual upholstery models, the higher of the two grades will determine price.

Tufting will help evenly distribute the wrinkling that will occur with certain leathers and fabrics.

NYC

RELAXED: MODULAR IN-LINE BENCHES

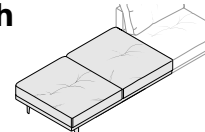
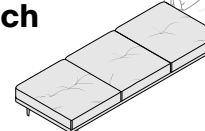
TITLE	SERIES	MODEL	STYLE	DIMENSIONS	COM	COL	Textile Upholstery Grades										Leather Upholstery Grades								
							YDG	SQFT	COM	A	B	C	D	E	F	G	H	I	J	K	L	M	W	X	Y
Modular 2/3-Seat In-line Bench Relaxed 	NY	07	3	20W x 34.5D x 17.5H	2.5	30	1,982	2,157	2,253	2,345	2,438	2,533	2,636	2,741	2,862	3,020	3,210	3,399	3,586	3,776	2,790	3,040	3,681	4,060	4,751
Modular One-Seat In-line Bench Relaxed 	NY	04	3	30W x 34.5D x 17.5H	3	40	2,290	2,549	2,691	2,829	2,972	3,112	3,269	3,426	3,607	3,845	4,129	4,412	4,692	4,976	3,343	3,671	4,513	5,004	5,913
Modular Two-Seat In-line Bench Relaxed 	NY	05	3	60W x 34.5D x 17.5H	5	74	3,661	4,097	4,332	4,562	4,800	5,035	5,295	5,553	5,859	6,255	6,729	7,203	7,667	8,141	5,602	6,210	7,756	8,666	10,333
Modular Three-Seat In-line Bench Relaxed 	NY	06	3	90W x 34.5D x 17.5H	7.5	100	5,339	5,949	6,280	6,601	6,931	7,263	7,627	7,989	8,417	8,972	9,635	10,296	10,947	11,610	8,164	9,046	11,297	12,620	15,048

To Order Select Below

1. Series/Model/Style

- NY073
NYC Modular, 2/3-Seat In-line Bench, Relaxed
- NY043
NYC Modular, One-Seat In-line Bench, Relaxed
- NY053
NYC Modular, Two-Seat In-line Bench, Relaxed
- NY063
NYC Modular, Three-Seat In-line Bench, Relaxed

2. Upholstery Style

- Upholstery Style**
DF DUAL UPHOLSTERY
Dual upholstery option allows for a second textile to be applied to NYC seats and backs.
- 2/3-Seat In-Line Bench**
Plinth 1.5 yds
Seat 2.0 yds
- One-Seat In-Line Bench**
Plinth 1.5 yds
Seat 2.5 yds
- Two-Seat In-Line Bench**
Plinth 2.0 yds
Seats 4.0 yds
- Three-Seat In-Line Bench**
Plinth 2.0 yds
Seats 6.0 yds

3. Leg Choice

- Leg Choice**
C1 ALUMINUM LEGS WITH ADJUSTABLE GLIDES

4. Leg Finish

- Standard Powder Coat**
 - BL BLUE
 - BM BLACK MATTE
 - BR BRASS
 - BT BLACK TWILIGHT
 - CP CHAMPAGNE
 - DB DARK BRONZE
 - DG DARK GRAY
 - DP DUSTY PINK
 - FG FOREST GREEN
 - LG LIGHT GRAY
 - MG MEADOW GREEN
 - MK MILK
 - MS METALLIC SILVER
 - Polished Metal**

	2/3-Seat 1-Seat	2-Seat	3-Seat
AL POLISHED ALUMINUM/CHROME	+223	+223	+297
- Chrome rails with polished aluminum legs.

5. Power

- Power**
Refer to power ordering steps on page 7.

6. Options

- Welt Cord**



	2/3-Seat 1-Seat	2-Seat	3-Seat
WI WELT CORD ON SEAT	+59	+118	+176
 - Options**
CT CONTRASTING THREAD
- Important Option Parameters**
Contrasting thread is not available with the welt cord option.

7. Upholstery

- Upholstery**
See general information section for details on textile program and COM/ COL information.
- Yardages provided are for non-directional fabrics that are applied railroaded. Directional fabrics may require additional yardage.
- When specifying dual upholstery models, the higher of the two grades will determine price.
- Tufting will help evenly distribute the wrinkling that will occur with certain leathers and fabrics.

NYC

RELAXED: STAND ALONE SEATING, 4IN ARM

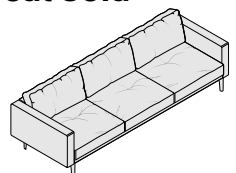
TITLE	SERIES	MODEL	STYLE	ARM	DIMENSIONS	Textile Upholstery Grades		Leather Upholstery Grades																		
						COM	COL	COM	A	B	C	D	E	F	G	H	I	J	K	L	M	W	X	Y	E1	E2
Stand Alone Club Chair Relaxed 4in Arm 	NY	11	3	B24	38W x 34.5D x 29.5H	7	98	4,680	5,215	5,503	5,786	6,073	6,364	6,680	6,999	7,373	7,857	8,438	9,017	9,588	10,167	7,291	8,108	10,190	11,412	13,656
Stand Alone Two-Seat Sofa Relaxed 4in Arm 	NY	12	3	B24	68W x 34.5D x 29.5H	11	154	7,056	7,901	8,360	8,805	9,264	9,725	10,229	10,733	11,326	12,097	13,019	13,938	14,842	15,764	11,042	12,288	15,612	17,334	20,762
Stand Alone Three-Seat Sofa Relaxed 4in Arm 	NY	13	3	B24	98W x 34.5D x 29.5H	14	209	9,428	10,696	11,387	12,054	12,744	13,434	14,191	14,947	15,837	16,995	18,373	19,754	21,110	22,491	14,835	16,523	20,831	23,366	28,009

To Order Select Below

1. Series/Model/Style/Arm

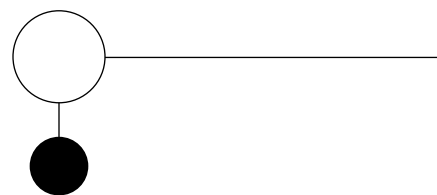

NY113B24
**NYC
Stand Alone, Club Chair
Relaxed, 4in Arm**

NY123B24
**NYC
Stand Alone, Two-Seat
Sofa, Relaxed, 4in Arm**

NY133B24
**NYC
Stand Alone, Three-Seat
Sofa, Relaxed, 4in Arm**

2. Upholstery Style

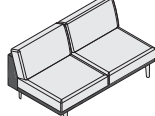

DF DUAL UPHOLSTERY
Dual upholstery option allows for a second textile to be applied to NYC seats and backs.

Club Chair
Plinth and Arms 4.5 yds
Seat and Back 3.5 yds

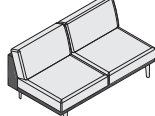
Two-Seat Sofa
Plinth and Arms 5.5 yds
Seats and Backs 6.0 yds

Three-Seat Sofa
Plinth and Arms 6.5 yds
Seats and Backs 8.0 yds

3. Leg Choice

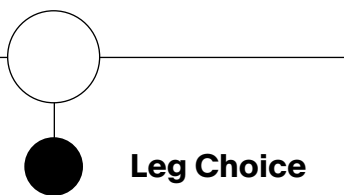

C1 ALUMINUM LEGS WITH ADJUSTABLE GLIDES

4. Leg Finish



Standard Powder Coat

BL	BLUE
BM	BLACK MATTE
BR	BRASS
BT	BLACK TWILIGHT
CP	CHAMPAGNE
DB	DARK BRONZE
DG	DARK GRAY
DP	DUSTY PINK
FG	FOREST GREEN
LG	LIGHT GRAY
MG	MEADOW GREEN
MK	MILK
MS	METALLIC SILVER

Polished Metal

	1-Seat	2-Seat	3-Seat
AL POLISHED ALUMINUM/CHROME	+223	+223	+297

Chrome rails with polished aluminum legs.

5. Power

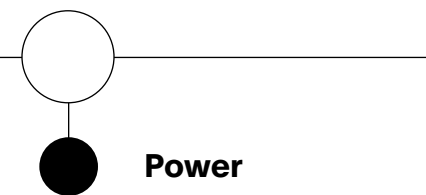

Power
Refer to power ordering steps on [page 7](#).

6. Options

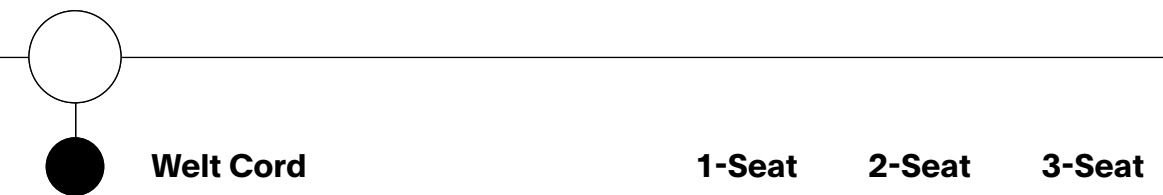

Welt Cord

	1-Seat	2-Seat	3-Seat
WI WELT CORD ON SEAT	+59	+118	+176
W3 WELT CORD ON SEAT AND BACK	+104	+208	+312

Options

CT CONTRASTING THREAD

Important Option Parameters
Contrasting thread is not available with the welt cord option.

7. Upholstery

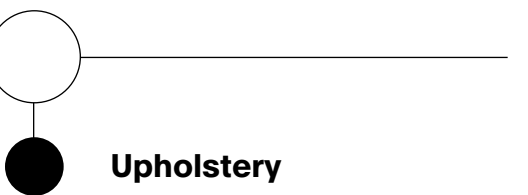

Upholstery
See general information section for details on textile program and COM/ COL information.

Yardages provided are for non-directional fabrics that are applied railroaded. Directional fabrics may require additional yardage.

When specifying dual upholstery models, the higher of the two grades will determine price.

Tufting will help evenly distribute the wrinkling that will occur with certain leathers and fabrics.

NYC

RELAXED: STAND ALONE SEATING, 6IN ARM

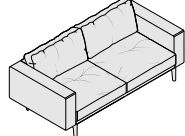
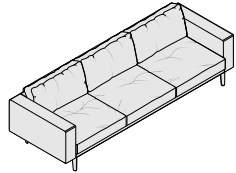
TITLE	SERIES	MODEL	STYLE	ARM	DIMENSIONS	COM	COL	Textile Upholstery Grades										Leather Upholstery Grades								
								YDG	SQFT	COM	A	B	C	D	E	F	G	H	I	J	K	L	M	W	X	Y
Stand Alone Club Chair Relaxed 6in Arm 	NY	11	3	B26	42W x 34.5D x 29.5H	7	98	4,680	5,215	5,503	5,786	6,073	6,364	6,680	6,999	7,373	7,857	8,438	9,017	9,588	10,167	7,291	8,108	10,190	11,412	13,656
Stand Alone Two-Seat Sofa Relaxed 6in Arm 	NY	12	3	B26	72W x 34.5D x 29.5H	11	154	7,056	7,901	8,360	8,805	9,264	9,725	10,229	10,733	11,326	12,097	13,019	13,938	14,842	15,764	11,042	12,288	15,612	17,334	20,762
Stand Alone Three-Seat Sofa Relaxed 6in Arm 	NY	13	3	B26	102W x 34.5D x 29.5H	14	209	9,428	10,696	11,387	12,054	12,744	13,434	14,191	14,947	15,837	16,995	18,373	19,754	21,110	22,491	14,835	16,523	20,831	23,366	28,009

To Order Select Below

1. Series/Model/Style/Arm

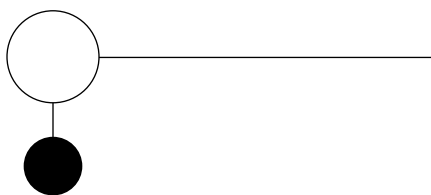

NY113B26
NYC
Stand Alone, Club Chair
Relaxed, 6in Arm

NY123B26
NYC
Stand Alone, Two-Seat
Sofa, Relaxed, 6in Arm

NY133B26
NYC
Stand Alone, Three-Seat
Sofa, Relaxed, 6in Arm

2. Upholstery Style



DF DUAL UPHOLSTERY
 Dual upholstery option allows for a second textile to be applied to NYC seats and backs.

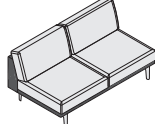

Club Chair
 Plinth and Arms 4.5 yds
 Seat and Back 3.5 yds

Two-Seat Sofa
 Plinth and Arms 5.5 yds
 Seats and Backs 6.0 yds

Three-Seat Sofa
 Plinth and Arms 6.5 yds
 Seats and Backs 9.0 yds

3. Leg Choice

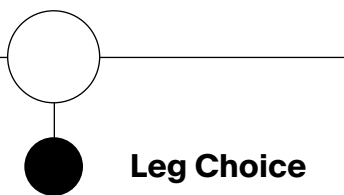

C1 ALUMINUM LEGS WITH ADJUSTABLE GLIDES

4. Leg Finish



Standard Powder Coat

BL	BLUE
BM	BLACK MATTE
BR	BRASS
BT	BLACK TWILIGHT
CP	CHAMPAGNE
DB	DARK BRONZE
DG	DARK GRAY
DP	DUSTY PINK
FG	FOREST GREEN
LG	LIGHT GRAY
MG	MEADOW GREEN
MK	MILK
MS	METALLIC SILVER

Polished Metal

	1-Seat	2-Seat	3-Seat	
AL	POLISHED ALUMINUM/CHROME	+223	+223	+297

Chrome rails with polished aluminum legs.

5. Power

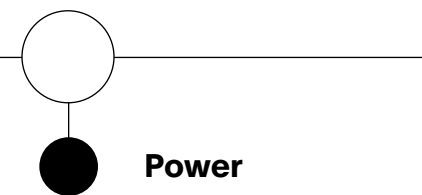

Power
 Refer to power ordering steps on [page 7](#).

6. Options

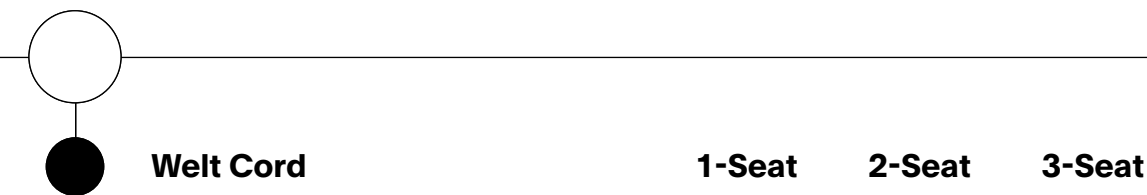

Welt Cord

WI	WELT CORD ON SEAT	+59	+118	+176
W3	WELT CORD ON SEAT AND BACK	+104	+208	+312

Options

CT	CONTRASTING THREAD
----	--------------------

Important Option Parameters
 Contrasting thread is not available with the welt cord option.

7. Upholstery



Upholstery
 See general information section for details on textile program and COM/ COL information.



Yardages provided are for non-directional fabrics that are applied railroaded. Directional fabrics may require additional yardage.

When specifying dual upholstery models, the higher of the two grades will determine price.

Tufting will help evenly distribute the wrinkling that will occur with certain leathers and fabrics.

NYC

RELAXED: STAND ALONE SEATING, 9IN ARM

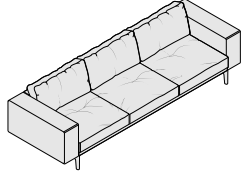
TITLE	SERIES	MODEL	STYLE	ARM	DIMENSIONS	COM	COL	Textile Upholstery Grades										Leather Upholstery Grades								
								YDG	SQFT	COM	A	B	C	D	E	F	G	H	I	J	K	L	M	W	X	Y
Stand Alone Club Chair Relaxed 9in Arm 	NY	11	3	B29	48W x 34.5D x 29.5H	9	102	4,680	5,400	5,792	6,169	6,560	6,950	7,380	7,809	8,315	8,968	9,750	10,533	11,301	12,083	7,409	8,259	10,433	11,712	14,053
Stand Alone Two-Seat Sofa Relaxed 9in Arm 	NY	12	3	B29	78W x 34.5D x 29.5H	13	159	7,056	7,901	8,360	8,805	9,264	9,725	10,229	10,733	11,326	12,097	13,019	13,938	14,842	15,764	11,157	12,439	15,857	17,632	21,159
Stand Alone Three-Seat Sofa Relaxed 9in Arm 	NY	13	3	B29	108W x 34.5D x 29.5H	16	214	9,428	10,781	11,516	12,228	12,965	13,699	14,509	15,313	16,265	17,497	18,970	20,441	21,889	23,360	14,949	16,673	21,074	23,662	28,405

To Order Select Below

1. Series/Model/Style/Arm

- NY113B29
NYC Stand Alone, Club Chair Relaxed, 9in Arm
- NY123B29
NYC Stand Alone, Two-Seat Sofa, Relaxed, 9in Arm
- NY133B29
NYC Stand Alone, Three-Seat Sofa, Relaxed, 9in Arm

2. Upholstery Style

- Upholstery Style**
DF DUAL UPHOLSTERY
Dual upholstery option allows for a second textile to be applied to NYC seats and backs.
- Club Chair**
Plinth and Arms 6.5 yds
Seat and Back 3.5 yds
- Two-Seat Sofa**
Plinth and Arms 7.5 yds
Seats and Backs 6.0 yds
- Three-Seat Sofa**
Plinth and Arms 9.0 yds
Seats and Backs 8.0 yds

3. Leg Choice

- Leg Choice**
C1 ALUMINUM LEGS WITH ADJUSTABLE GLIDES

4. Leg Finish

- Standard Powder Coat**

BL	BLUE	NK	NICKEL
BM	BLACK MATTE	NV	NAVY
BR	BRASS	OR	ORANGE
BT	BLACK TWILIGHT	PY	PALE YELLOW
CP	CHAMPAGNE	RD	RED
DB	DARK BRONZE	RO	RED ORANGE
DG	DARK GRAY	RR	RUSTY RED
DP	DUSTY PINK	SB	SOFT BLUE
FG	FOREST GREEN	SD	SAND
LG	LIGHT GRAY	TC	TERRACOTTA
MG	MEADOW GREEN	TP	TAUPE
MK	MILK	TS	TEXTURED SLATE
MS	METALLIC SILVER	YL	YELLOW
- Polished Metal**

	1-Seat	2-Seat	3-Seat
AL POLISHED ALUMINUM/CHROME	+223	+223	+297

Chrome rails with polished aluminum legs.

5. Power

- Power**
Refer to power ordering steps on page 7.

6. Options

- Welt Cord**



	1-Seat	2-Seat	3-Seat
WI WELT CORD ON SEAT	+59	+118	+176
W3 WELT CORD ON SEAT AND BACK	+104	+208	+312
 - Options**
CT CONTRASTING THREAD
- Important Option Parameters**
Contrasting thread is not available with the welt cord option.

7. Upholstery

- Upholstery**
See general information section for details on textile program and COM/ COL information.
- Yardages provided are for non-directional fabrics that are applied railroaded. Directional fabrics may require additional yardage.
- When specifying dual upholstery models, the higher of the two grades will determine price.
- Tufting will help evenly distribute the wrinkling that will occur with certain leathers and fabrics.

NYC

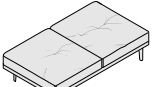
RELAXED: STAND ALONE BENCHES

TITLE	SERIES	MODEL	STYLE	DIMENSIONS	COM	COL	Textile Upholstery Grades										Leather Upholstery Grades								
							YDG	SQFT	COM	A	B	C	D	E	F	G	H	I	J	K	L	M	W	X	Y
Stand Alone One-Seat Bench Relaxed 	NY	01	3	30W x 33.5D x 17.5H	3	40	2,898	3,161	3,302	3,440	3,582	3,723	3,879	4,035	4,219	4,455	4,739	5,021	5,303	5,586	3,954	4,280	5,122	5,615	6,522
Stand Alone Two-Seat Bench Relaxed 	NY	02	3	60W x 33.5D x 17.5H	5.5	74	3,661	4,097	4,332	4,562	4,800	5,035	5,295	5,553	5,859	6,255	6,729	7,203	7,667	8,141	5,602	6,210	7,756	8,666	10,333
Stand Alone Three-Seat Bench Relaxed 	NY	03	3	90W x 33.5D x 17.5H	7.5	100	5,339	5,949	6,280	6,601	6,931	7,263	7,627	7,989	8,417	8,972	9,635	10,296	10,947	11,610	8,164	9,046	11,297	12,620	15,048

To Order Select Below

1. Series/Model/Style

NY013	NYC Stand Alone, One-Seat Bench, Relaxed
NY023	NYC Stand Alone, Two-Seat Bench, Relaxed
NY033	NYC Stand-Alone, Three-Seat Bench, Relaxed

2. Upholstery Style

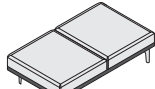
DF	DUAL UPHOLSTERY
Dual upholstery option allows for a second textile to be applied to NYC seats and backs.	
	
One-Seat Stand Alone Bench	
Plinth	1.5 yds
Seat	2.0 yds
Two-Seat Stand Alone Bench	
Plinth	2.0 yds
Seats	4.0 yds
Three-Seat Stand Alone Bench	
Plinth	2.0 yds
Seats	6.0 yds

3. Leg Choice

C1	ALUMINUM LEGS WITH ADJUSTABLE GLIDES
----	--------------------------------------

4. Leg Finish

BL	BLUE	NK	NICKEL	
BM	BLACK MATTE	NV	NAVY	
BR	BRASS	OR	ORANGE	
BT	BLACK TWILIGHT	PY	PALE YELLOW	
CP	CHAMPAGNE	RD	RED	
DB	DARK BRONZE	RO	RED ORANGE	
DG	DARK GRAY	RR	RUSTY RED	
DP	DUSTY PINK	SB	SOFT BLUE	
FG	FOREST GREEN	SD	SAND	
LG	LIGHT GRAY	TC	TERRACOTTA	
MG	MEADOW GREEN	TP	TAUPE	
MK	MILK	TS	TEXTURED SLATE	
MS	METALLIC SILVER	YL	YELLOW	
Polished Metal		1-Seat	2-Seat	3-Seat
AL	POLISHED ALUMINUM/CHROME	+223	+223	+297

Chrome rails with polished aluminum legs.

5. Power

Power
Refer to power ordering steps on [page 7](#).

6. Options

WI	WELT CORD ON SEAT	+59	+118	+176
Options				
CT	CONTRASTING THREAD			
Important Option Parameters Contrasting thread is not available with the welt cord option.				

7. Upholstery

Upholstery
See general information section for details on textile program and COM/ COL information.



Yardages provided are for non-directional fabrics that are applied railroaded. Directional fabrics may require additional yardage.

When specifying dual upholstery models, the higher of the two grades will determine price.

Tufting will help evenly distribute the wrinkling that will occur with certain leathers and fabrics.

NYC

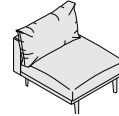
LOOSE: MODULAR SEATING

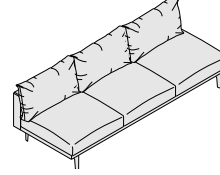
TITLE	SERIES	MODEL	STYLE	DIMENSIONS	COM	COL	Textile Upholstery Grades										Leather Upholstery Grades								
							YDG	SQFT	COM	A	B	C	D	E	F	G	H	I	J	K	L	M	W	X	Y
Modular One-Seat Unit Loose Full Back Cushion 	NY	11	5	30W x 34.5D x 31H	5	78	3,561	3,983	4,213	4,435	4,666	4,894	5,147	5,400	5,696	6,082	6,543	7,004	7,454	7,915	5,397	5,892	7,567	8,191	9,147
Modular Two-Seat Unit Loose Full Back Cushion 	NY	12	5	60W x 34.5D x 31H	8.5	135	5,787	6,461	6,830	7,187	7,554	7,921	8,325	8,730	9,203	9,822	10,556	11,293	12,016	12,752	8,944	9,797	13,075	14,715	16,669
Modular Three-Seat Unit Loose Full Back Cushion 	NY	13	5	90W x 34.5D x 31H	12	199	8,012	8,941	9,447	9,937	10,442	10,947	11,504	12,058	12,710	13,560	14,571	15,581	16,576	17,590	12,681	13,939	18,790	21,143	24,479

To Order Select Below

1. Series/Model/Style

- NY115
**NYC
Modular, One-Seat Unit,
Loose, Full Back Cushion**
- NY125
**NYC
Modular, Two-Seat Unit,
Loose, Full Back Cushion**
- NY135
**NYC
Modular, Three-Seat Unit,
Loose, Full Back Cushion**

2. Upholstery Style

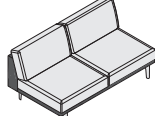
- Upholstery Style**
DF DUAL UPHOLSTERY
Dual upholstery option allows for a second textile to be applied to NYC seats and backs.

- One-Seat**
Plinth 2.1 yds
Seat and Back 3.2 yds
- Two-Seat**
Plinth 3.0 yds
Seats and Backs 5.5 yds
- Three-Seat**
Plinth 4.0 yds
Seats and Backs 8.5 yds

3. Leg Choice

- Leg Choice**
C1 ALUMINUM LEGS WITH ADJUSTABLE GLIDES

4. Leg Finish

- Standard Powder Coat**
 - BL BLUE
 - BM BLACK MATTE
 - BR BRASS
 - BT BLACK TWILIGHT
 - CP CHAMPAGNE
 - DB DARK BRONZE
 - DG DARK GRAY
 - DP DUSTY PINK
 - FG FOREST GREEN
 - LG LIGHT GRAY
 - MG MEADOW GREEN
 - MK MILK
 - MS METALLIC SILVER
- Polished Metal**

	1-Seat	2-Seat	3-Seat
AL POLISHED ALUMINUM/CHROME	+223	+223	+297

Chrome rails with polished aluminum legs.

5. Power

- Power**
Refer to power ordering steps on [page 7](#).

6. Options

- Options**
CT CONTRASTING THREAD

7. Upholstery



- Upholstery**
See [general information section](#) for details on textile program and COM/COL information.

Yardages provided are for non-directional fabrics that are applied railroaded. Directional fabrics may require additional yardage.

When specifying dual upholstery models, the higher of the two grades will determine price.

NYC

LOOSE: MODULAR SEATING

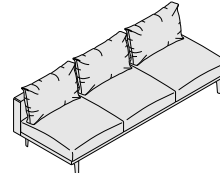
TITLE	SERIES	MODEL	STYLE	DIMENSIONS	COM	COL	Textile Upholstery Grades										Leather Upholstery Grades								
							YDG	SQFT	COM	A	B	C	D	E	F	G	H	I	J	K	L	M	W	X	Y
Modular One-Seat Unit Loose Partial Back Cushion 	NY	11	4	30W x 34.5D x 31H	5	78	3,561	3,983	4,213	4,435	4,666	4,894	5,147	5,400	5,696	6,082	6,543	7,004	7,454	7,915	5,397	5,892	7,567	8,191	9,147
Modular Two-Seat Unit Loose Partial Back Cushion 	NY	12	4	60W x 34.5D x 31H	8.5	135	5,787	6,461	6,830	7,187	7,554	7,921	8,325	8,730	9,203	9,822	10,556	11,293	12,016	12,752	8,944	9,797	13,075	14,715	16,669
Modular Three-Seat Unit Loose Partial Back Cushion 	NY	13	4	90W x 34.5D x 31H	12	199	8,012	8,941	9,447	9,937	10,442	10,947	11,504	12,058	12,710	13,560	14,571	15,581	16,576	17,590	12,681	13,939	18,790	21,143	24,479

To Order Select Below

1. Series/Model/Style

- NY114
**NYC
Modular, One-Seat Unit,
Loose, Partial Back
Cushion**
- NY124
**NYC
Modular, Two-Seat Unit,
Loose, Partial Back
Cushion**
- NY134
**NYC
Modular, Three-Seat Unit,
Loose, Partial Back
Cushion**

2. Upholstery Style

- Upholstery Style**

DF DUAL UPHOLSTERY

Dual upholstery option allows for a second textile to be applied to NYC seats and backs.

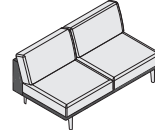

One-Seat
Plinth 2.1 yds
Seat and Back 3.2 yds

Two-Seat
Plinth 3.0 yds
Seats and Backs 5.5 yds

Three-Seat
Plinth 4.0 yds
Seats and Backs 8.5 yds

3. Leg Choice

- Leg Choice**

C1 ALUMINUM LEGS WITH ADJUSTABLE GLIDES

4. Leg Finish

- Standard Powder Coat**

BL	BLUE	NK	NICKEL
BM	BLACK MATTE	NV	NAVY
BR	BRASS	OR	ORANGE
BT	BLACK TWILIGHT	PY	PALE YELLOW
CP	CHAMPAGNE	RD	RED
DB	DARK BRONZE	RO	RED ORANGE
DG	DARK GRAY	RR	RUSTY RED
DP	DUSTY PINK	SB	SOFT BLUE
FG	FOREST GREEN	SD	SAND
LG	LIGHT GRAY	TC	TERRACOTTA
MG	MEADOW GREEN	TP	TAUPE
MK	MILK	TS	TEXTURED SLATE
MS	METALLIC SILVER	YL	YELLOW
- Polished Metal**

	1-Seat	2-Seat	3-Seat
AL	POLISHED ALUMINUM/CHROME	+223	+223 +297

Chrome rails with polished aluminum legs.

5. Power

- Power**

Refer to power ordering steps on [page 7](#).

6. Options

- Options**

CT CONTRASTING THREAD

7. Upholstery

- Upholstery**

See [general information section](#) for details on textile program and COM/COL information.

Yardages provided are for non-directional fabrics that are applied railroaded. Directional fabrics may require additional yardage.

When specifying dual upholstery models, the higher of the two grades will determine price.

NYC

LOOSE: MODULAR SEATING

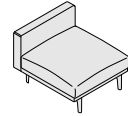
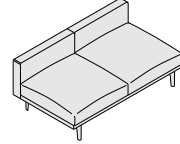
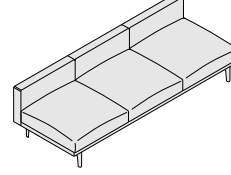
TITLE	SERIES	MODEL	STYLE	DIMENSIONS	COM	COL	Textile Upholstery Grades										Leather Upholstery Grades								
							YDG	SQFT	COM	A	B	C	D	E	F	G	H	I	J	K	L	M	W	X	Y
Modular One-Seat Unit Loose No Back																									
	NY	11	6	30W x 34.5D x 25.25H	4	56	3,079	3,416	3,600	3,780	3,963	4,148	4,348	4,550	4,787	5,098	5,463	5,831	6,193	6,561	4,401	4,759	6,087	6,863	7,607
Modular Two-Seat Unit Loose No Back																									
	NY	12	6	60W x 34.5D x 25.25H	6	94	4,823	5,328	5,605	5,873	6,149	6,423	6,727	7,029	7,385	7,848	8,401	8,952	9,495	10,046	7,035	7,631	9,931	11,968	13,377
Modular Three-Seat Unit Loose No Back																									
	NY	13	6	90W x 34.5D x 25.25H	8.5	139	6,565	7,283	7,673	8,052	8,444	8,835	9,262	9,693	10,196	10,852	11,633	12,416	13,185	13,966	9,829	10,712	14,102	17,154	19,247

To Order Select Below

1. Series/Model/Style

- NY116
**NYC
Modular, One-Seat Unit,
Loose, No Back**
- NY126
**NYC
Modular, Two-Seat Unit,
Loose, No Back**
- NY136
**NYC
Modular, Three-Seat Unit,
Loose, No Back**

2. Upholstery Style

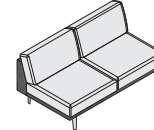
- Upholstery Style**
DF DUAL UPHOLSTERY
Dual upholstery option allows for a second textile to be applied to NYC seats and backs.
- 
One-Seat
Plinth 2.0 yds
Seat 2.0 yds
- Two-Seat**
Plinth 3.0 yds
Seats 3.0 yds
- Three-Seat**
Plinth 4.0 yds
Seats 4.5 yds

3. Leg Choice

- Leg Choice**
ALUMINUM LEGS WITH ADJUSTABLE GLIDES
C1

4. Leg Finish

- Standard Powder Coat**
 - BL BLUE
 - BM BLACK MATTE
 - BR BRASS
 - BT BLACK TWILIGHT
 - CP CHAMPAGNE
 - DB DARK BRONZE
 - DG DARK GRAY
 - DP DUSTY PINK
 - FG FOREST GREEN
 - LG LIGHT GRAY
 - MG MEADOW GREEN
 - MK MILK
 - MS METALLIC SILVER
- Polished Metal**

	1-Seat	2-Seat	3-Seat
AL POLISHED ALUMINUM/CHROME	+223	+223	+297

Chrome rails with polished aluminum legs.

5. Power

- Power**
Refer to power ordering steps on [page 7](#).

6. Options

- Options**
CT CONTRASTING THREAD

7. Upholstery

- Upholstery**
See general information section for details on textile program and COM/COL information.

Yardages provided are for non-directional fabrics that are applied railroaded. Directional fabrics may require additional yardage.

When specifying dual upholstery models, the higher of the two grades will determine price.

NYC

LOOSE: MODULAR CORNERS

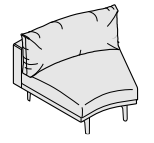
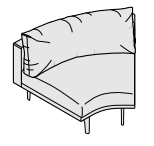
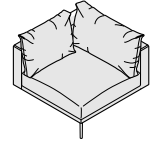
TITLE	SERIES	MODEL	STYLE	DIMENSIONS	COM	COL	Textile Upholstery Grades										Leather Upholstery Grades								
							YDG	SQFT	COM	A	B	COL	C	D	E	F	G	H	I	J	K	L	M	W	X
Modular 135 Degree Corner Loose Full Back Cushion 	NY	14	5	42W x 34.5D x 31H	6.3	82	4,153	4,661	4,936	5,204	5,482	5,756	6,061	6,362	6,718	7,179	7,730	8,285	8,826	9,379	6,069	6,587	8,482	8,783	9,739
Modular 150 Degree Corner Loose Full Back Cushion 	NY	15	5	40.38W x 34.5D x 31H	6	82	4,153	4,661	4,936	5,204	5,482	5,756	6,061	6,362	6,718	7,179	7,730	8,285	8,826	9,379	6,069	6,587	8,482	8,783	9,739
Modular 90 Degree Corner Loose Full Back Cushion 	NY	16	5	47.88W x 34.5D x 31H	6	110	4,450	4,873	5,103	5,326	5,556	5,787	6,038	6,290	6,587	6,973	7,432	7,893	8,344	8,805	7,040	7,741	10,012	11,146	12,732

To Order Select Below

1. Series/Model/Style

- NY145
NYC Modular, 135° Corner, Loose, Full Back Cushion
- NY155
NYC Modular, 150° Corner, Loose, Full Back Cushion
- NY165
NYC Modular, 90° Corner, Loose, Full Back Cushion

2. Upholstery Style

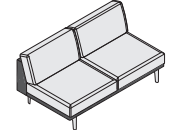
- Upholstery Style**
DF DUAL UPHOLSTERY
Dual upholstery option allows for a second textile to be applied to NYC seats and backs.

- 135° Corner**
Plinth 3.0 yds
Seat and Back 4.0 yds
- 150° Corner**
Plinth 3.0 yds
Seat and Back 4.0 yds
- 90° Corner**
Plinth 3.0 yds
Seat and Backs 4.0 yds

3. Leg Choice

- Leg Choice**
C1 ALUMINUM LEGS WITH ADJUSTABLE GLIDES

4. Leg Finish

- Standard Powder Coat**
 - BL BLUE
 - BM BLACK MATTE
 - BR BRASS
 - BT BLACK TWILIGHT
 - CP CHAMPAGNE
 - DB DARK BRONZE
 - DG DARK GRAY
 - DP DUSTY PINK
 - FG FOREST GREEN
 - LG LIGHT GRAY
 - MG MEADOW GREEN
 - MK MILK
 - MS METALLIC SILVER
 - NK NICKEL
 - NV NAVY
 - OR ORANGE
 - PY PALE YELLOW
 - RD RED
 - RO RED ORANGE
 - RR RUSTY RED
 - SB SOFT BLUE
 - SD SAND
 - TC TERRACOTTA
 - TP TAUPE
 - TS TEXTURED SLATE
 - YL YELLOW
- Polished Metal**
AL POLISHED ALUMINUM/CHROME **+223**

Chrome rails with polished aluminum legs.

5. Power

- Power**
Refer to power ordering steps on [page 7](#).

6. Options

- Options**
CT CONTRASTING THREAD

7. Upholstery

- Upholstery**
See general information section for details on textile program and COM/COL information.

Yardages provided are for non-directional fabrics that are applied railroaded. Directional fabrics may require additional yardage.

When specifying dual upholstery models, the higher of the two grades will determine price.

NYC

LOOSE: MODULAR CORNERS

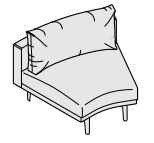
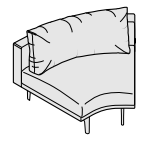
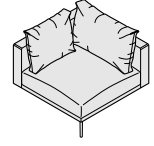
TITLE	SERIES	MODEL	STYLE	DIMENSIONS	COM	COL	Textile Upholstery Grades										Leather Upholstery Grades								
							YDG	SQFT	COM	A	B	COL	C	D	E	F	G	H	I	J	K	L	M	W	X
Modular 135 Degree Corner Loose Partial Back Cushion 	NY	14	4	42W x 34.5D x 31H	6.3	82	4,153	4,661	4,936	5,204	5,482	5,756	6,061	6,362	6,718	7,179	7,730	8,285	8,826	9,379	6,069	6,587	8,482	8,783	9,739
Modular 150 Degree Corner Loose Partial Back Cushion 	NY	15	4	40.38W x 34.5D x 31H	6	82	4,153	4,661	4,936	5,204	5,482	5,756	6,061	6,362	6,718	7,179	7,730	8,285	8,826	9,379	6,069	6,587	8,482	8,783	9,739
Modular 90 Degree Corner Loose Partial Back Cushion 	NY	16	4	47.88W x 34.5D x 31H	6	110	4,450	4,873	5,103	5,326	5,556	5,787	6,038	6,290	6,587	6,973	7,432	7,893	8,344	8,805	7,040	7,741	10,012	11,146	12,732

To Order Select Below

1. Series/Model/Style

- NY144
NYC Modular, 135° Corner, Loose, Partial Back Cushion
- NY154
NYC Modular, 150° Corner, Loose, Partial Back Cushion
- NY164
NYC Modular, 90° Corner, Loose, Partial Back Cushion

2. Upholstery Style

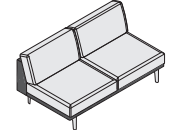
- Upholstery Style**
DF DUAL UPHOLSTERY
Dual upholstery option allows for a second textile to be applied to NYC seats and backs.

135° Corner
Plinth 3.0 yds
Seat and Back 4.0 yds
150° Corner
Plinth 3.0 yds
Seat and Back 4.0 yds
90° Corner
Plinth 3.0 yds
Seat and Backs 4.0 yds

3. Leg Choice

- Leg Choice**
C1 ALUMINUM LEGS WITH ADJUSTABLE GLIDES

4. Leg Finish

- Standard Powder Coat**
 - BL BLUE
 - BM BLACK MATTE
 - BR BRASS
 - BT BLACK TWILIGHT
 - CP CHAMPAGNE
 - DB DARK BRONZE
 - DG DARK GRAY
 - DP DUSTY PINK
 - FG FOREST GREEN
 - LG LIGHT GRAY
 - MG MEADOW GREEN
 - MK MILK
 - MS METALLIC SILVER
 - NK NICKEL
 - NV NAVY
 - OR ORANGE
 - PY PALE YELLOW
 - RD RED
 - RO RED ORANGE
 - RR RUSTY RED
 - SB SOFT BLUE
 - SD SAND
 - TC TERRACOTTA
 - TP TAUPE
 - TS TEXTURED SLATE
 - YL YELLOW
- Polished Metal**
AL POLISHED ALUMINUM/CHROME +223

Chrome rails with polished aluminum legs.

5. Power

- Power**
Refer to power ordering steps on [page 7](#).

6. Options

- Options**
CT CONTRASTING THREAD

7. Upholstery

- Upholstery**
See [general information section](#) for details on textile program and COM/COL information.
Yardages provided are for non-directional fabrics that are applied railroaded. Directional fabrics may require additional yardage.
When specifying dual upholstery models, the higher of the two grades will determine price.

NYC

LOOSE: MODULAR CORNERS

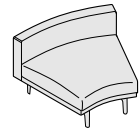
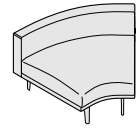
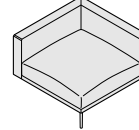
TITLE	SERIES	MODEL	STYLE	DIMENSIONS	COM	COL	Textile Upholstery Grades										Leather Upholstery Grades								
							YDG	SQFT	COM	A	B	COL	C	D	E	F	G	H	I	J	K	L	M	W	X
Modular 135 Degree Corner Loose No Back 	NY	14	6	42W x 34.5D x 25.25H	5	59	3,411	3,836	4,065	4,286	4,518	4,748	5,000	5,250	5,547	5,935	6,395	6,855	7,306	7,767	4,788	5,159	6,590	7,225	7,962
Modular 150 Degree Corner Loose No Back 	NY	15	6	40.38W x 34.5D x 25.25H	4.5	59	3,411	3,793	4,001	4,199	4,406	4,615	4,839	5,066	5,334	5,682	6,096	6,509	6,918	7,331	4,788	5,159	6,590	7,225	7,962
Modular 90 Degree Corner Loose No Back 	NY	16	6	47.88W x 34.5D x 25.25H	4.5	72	3,561	3,898	4,083	4,262	4,446	4,629	4,830	5,031	5,270	5,579	5,945	6,314	6,676	7,044	5,262	5,718	7,416	8,031	8,954

To Order Select Below

1. Series/Model/Style

- NY146
NYC Modular, 135° Corner, Loose, No Back
- NY156
NYC Modular, 150° Corner, Loose, No Back
- NY166
NYC Modular, 90° Corner, Loose, No Back

2. Upholstery Style

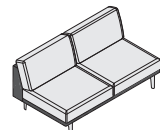
- Upholstery Style**
DF DUAL UPHOLSTERY
Dual upholstery option allows for a second textile to be applied to NYC seats and backs.

- 135° Corner**
Plinth 3.0 yds
Seat 2.0 yds
- 150° Corner**
Plinth 3.0 yds
Seat 2.0 yds
- 90° Corner**
Plinth 3.0 yds
Seat 2.0 yds

3. Leg Choice

- Leg Choice**
C1 ALUMINUM LEGS WITH ADJUSTABLE GLIDES

4. Leg Finish

- Standard Powder Coat**
 - BL BLUE
 - BM BLACK MATTE
 - BR BRASS
 - BT BLACK TWILIGHT
 - CP CHAMPAGNE
 - DB DARK BRONZE
 - DG DARK GRAY
 - DP DUSTY PINK
 - FG FOREST GREEN
 - LG LIGHT GRAY
 - MG MEADOW GREEN
 - MK MILK
 - MS METALLIC SILVER
 - NK NICKEL
 - NV NAVY
 - OR ORANGE
 - PY PALE YELLOW
 - RD RED
 - RO RED ORANGE
 - RR RUSTY RED
 - SB SOFT BLUE
 - SD SAND
 - TC TERRACOTTA
 - TP TAUPE
 - TS TEXTURED SLATE
 - YL YELLOW
- Polished Metal**
AL POLISHED ALUMINUM/CHROME **+223**

Chrome rails with polished aluminum legs.

5. Power

- Power**
Refer to power ordering steps on [page 7](#).

6. Options

- Options**
CT CONTRASTING THREAD

7. Upholstery

- Upholstery**
See general information section for details on textile program and COM/COL information.

Yardages provided are for non-directional fabrics that are applied railroaded. Directional fabrics may require additional yardage.

When specifying dual upholstery models, the higher of the two grades will determine price.

NYC

LOOSE: MODULAR IN-LINE BENCHES

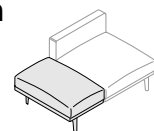
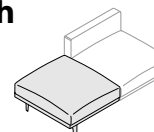
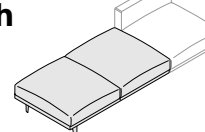
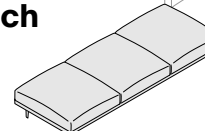
TITLE	SERIES	MODEL	STYLE	DIMENSIONS	COM	COL	Textile Upholstery Grades										Leather Upholstery Grades								
							YDG	SQFT	COM	A	B	C	D	E	F	G	H	I	J	K	L	M	W	X	Y
Modular 2/3-Seat In-line Bench Loose 	NY	07	6	20W x 34.5D x 17.5H	3	47	1,831	2,093	2,233	2,370	2,513	2,654	2,809	2,966	3,148	3,388	3,671	3,955	4,235	4,519	2,809	3,060	3,944	4,341	5,074
Modular One-Seat In-line Bench Loose 	NY	04	6	30W x 34.5D x 17.5H	3	58	2,137	2,398	2,539	2,676	2,819	2,961	3,114	3,272	3,455	3,694	3,975	4,259	4,539	4,824	3,354	3,666	4,767	5,270	6,187
Modular Two-Seat In-line Bench Loose 	NY	05	6	60W x 34.5D x 17.5H	5.5	115	3,357	3,793	4,028	4,257	4,494	4,730	4,990	5,248	5,553	5,950	6,424	6,899	7,363	7,836	5,526	6,099	8,071	8,990	10,671
Modular Three-Seat In-line Bench Loose 	NY	06	6	90W x 34.5D x 17.5H	7.5	173	4,881	5,492	5,823	6,143	6,474	6,805	7,168	7,532	7,960	8,513	9,176	9,840	10,491	11,154	8,036	8,869	11,738	13,071	15,519

To Order Select Below

1. Series/Model/Style

- NY076
NYC Modular, 2/3-Seat In-line Bench, Loose
- NY046
NYC Modular, One-Seat In-line Bench, Loose
- NY056
NYC Modular, Two-Seat In-line Bench, Loose
- NY066
NYC Modular, Three-Seat In-line Bench, Loose

2. Upholstery Style

- Upholstery Style**
DF DUAL UPHOLSTERY
Dual upholstery option allows for a second textile to be applied to NYC seats and backs.
- 2/3-Seat In-Line Bench**
Plinth 1.5 yds
Seat 2.0 yds
- One-Seat In-Line Bench**
Plinth 1.5 yds
Seat 2.5 yds
- Two-Seat In-Line Bench**
Plinth 2.0 yds
Seats 4.0 yds
- Three-Seat In-Line Bench**
Plinth 2.0 yds
Seats 5.5 yds

3. Leg Choice

- Leg Choice**
C1 ALUMINUM LEGS WITH ADJUSTABLE GLIDES

4. Leg Finish

- Standard Powder Coat**

BL	BLUE	NK	NICKEL
BM	BLACK MATTE	NV	NAVY
BR	BRASS	OR	ORANGE
BT	BLACK TWILIGHT	PY	PALE YELLOW
CP	CHAMPAGNE	RD	RED
DB	DARK BRONZE	RO	RED ORANGE
DG	DARK GRAY	RR	RUSTY RED
DP	DUSTY PINK	SB	SOFT BLUE
FG	FOREST GREEN	SD	SAND
LG	LIGHT GRAY	TC	TERRACOTTA
MG	MEADOW GREEN	TP	TAUPE
MK	MILK	TS	TEXTURED SLATE
MS	METALLIC SILVER	YL	YELLOW
- Polished Metal**

	1-Seat	2-Seat	3-Seat	
AL	POLISHED ALUMINUM/CHROME	+223	+223	+297

Chrome rails with polished aluminum legs.

5. Power

- Power**
Refer to power ordering steps on [page 7](#).

6. Options

- Options**
CT CONTRASTING THREAD

7. Upholstery

- Upholstery**
See general information section for details on textile program and COM/COL information.

Yardages provided are for non-directional fabrics that are applied railroaded. Directional fabrics may require additional yardage.

When specifying dual upholstery models, the higher of the two grades will determine price.

NYC

LOOSE: STAND ALONE SEATING, 4IN ARM

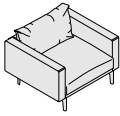
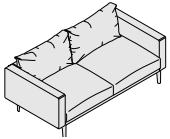
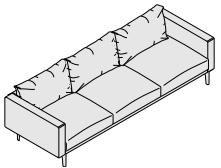
TITLE	SERIES	MODEL	STYLE	DIMENSIONS	YDG	SQFT	Textile Upholstery Grades										Leather Upholstery Grades									
							COM	COL	COM	A	B	C	D	E	F	G	H	I	J	K	L	M	W	X	Y	E1
Stand Alone Club Chair Loose 4in Arm Full Back Cushion 	NY	11	5	B24	38W x 34.5D x 31H	7	112	4,533	5,126	5,446	5,758	6,078	6,403	6,756	7,110	7,524	8,064	8,708	9,350	9,983	10,629	7,181	7,893	10,642	11,561	13,011
Stand Alone Two-Seat Sofa Loose 4in Arm Full Back Cushion 	NY	12	5	B24	68W x 34.5D x 31H	11	169	6,759	7,603	8,064	8,508	8,968	9,428	9,934	10,436	11,030	11,803	12,723	13,642	14,547	15,467	10,729	11,798	15,919	18,176	20,534
Stand Alone Three-Seat Sofa Loose 4in Arm Full Back Cushion 	NY	13	5	B24	98W x 34.5D x 31H	14	233	8,984	10,082	10,682	11,259	11,857	12,455	13,111	13,767	14,538	15,540	16,736	17,932	19,108	20,303	14,465	15,941	21,633	24,992	28,344

To Order Select Below

1. Series/Model/Style/Arm

- NY115B24

NYC
Stand Alone, Club Chair
Loose, 4in Arm,
Full Back Cushion
- NY125B24

NYC
Stand Alone, Two-Seat
Sofa, Loose, 4in Arm,
Full Back Cushion
- NY135B24

NYC
Stand Alone, Three-Seat
Sofa, Loose, 4in Arm,
Full Back Cushion

2. Upholstery Style

- Upholstery Style**

DF DUAL UPHOLSTERY

Dual upholstery option allows for a second textile to be applied to NYC seats and backs.

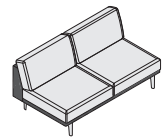

Club Chair
Plinth and Arms 4.5 yds
Seat and Back 3.2 yds

Two-Seat Sofa
Plinth and Arms 5.5 yds
Seats and Backs 5.5 yds

Three-Seat Sofa
Plinth and Arms 6.5 yds
Seats and Backs 8.5 yds

3. Leg Choice

- Leg Choice**

C1 ALUMINUM LEGS WITH ADJUSTABLE GLIDES

4. Leg Finish

- Standard Powder Coat**

BL	BLUE	NK	NICKEL
BM	BLACK MATTE	NV	NAVY
BR	BRASS	OR	ORANGE
BT	BLACK TWILIGHT	PY	PALE YELLOW
CP	CHAMPAGNE	RD	RED
DB	DARK BRONZE	RO	RED ORANGE
DG	DARK GRAY	RR	RUSTY RED
DP	DUSTY PINK	SB	SOFT BLUE
FG	FOREST GREEN	SD	SAND
LG	LIGHT GRAY	TC	TERRACOTTA
MG	MEADOW GREEN	TP	TAUPE
MK	MILK	TS	TEXTURED SLATE
MS	METALLIC SILVER	YL	YELLOW
- Polished Metal**

	1-Seat	2-Seat	3-Seat
AL	POLISHED ALUMINUM/CHROME	+223	+223 +297

Chrome rails with polished aluminum legs.

5. Power

- Power**

Refer to power ordering steps on [page 7](#).

6. Options

- Options**

CT CONTRASTING THREAD

7. Upholstery

- Upholstery**

See general information section for details on textile program and COM/COL information.

Yardages provided are for non-directional fabrics that are applied railroaded. Directional fabrics may require additional yardage.

When specifying dual upholstery models, the higher of the two grades will determine price.

NYC

LOOSE: STAND ALONE SEATING, 4IN ARM

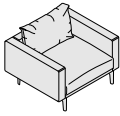
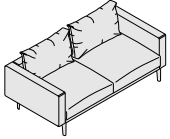
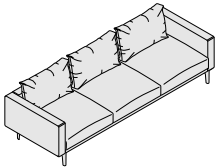
TITLE	SERIES	MODEL	STYLE	DIMENSIONS	YDG	SQFT	Textile Upholstery Grades										Leather Upholstery Grades									
							COM	COL	COM	A	B	C	D	E	F	G	H	I	J	K	L	M	W	X	Y	E1
Stand Alone Club Chair Loose 4in Arm Partial Back Cushion 	NY	11	4	B24	38W x 34.5D x 31H	7	112	4,533	5,126	5,446	5,758	6,078	6,403	6,756	7,110	7,524	8,064	8,708	9,350	9,983	10,629	7,181	7,893	10,642	11,561	13,011
Stand Alone Two-Seat Sofa Loose 4in Arm Partial Back Cushion 	NY	12	4	B24	68W x 34.5D x 31H	11	169	6,759	7,603	8,064	8,508	8,968	9,428	9,934	10,436	11,030	11,803	12,723	13,642	14,547	15,467	10,729	11,798	15,919	18,176	20,534
Stand Alone Three-Seat Sofa Loose 4in Arm Partial Back Cushion 	NY	13	4	B24	98W x 34.5D x 31H	14	233	8,984	10,082	10,682	11,259	11,857	12,455	13,111	13,767	14,538	15,540	16,736	17,932	19,108	20,303	14,465	15,941	21,633	24,992	28,344

To Order Select Below

1. Series/Model/Style/Arm

- NY114B24

NYC
Stand Alone, Club Chair
Loose, 4in Arm,
Partial Back Cushion
- NY124B24

NYC
Stand Alone, Two-Seat
Sofa, Loose, 4in Arm,
Partial Back Cushion
- NY134B24

NYC
Stand Alone, Three-Seat
Sofa, Loose, 4in Arm,
Partial Back Cushion

2. Upholstery Style

- Upholstery Style**

DF DUAL UPHOLSTERY

Dual upholstery option allows for a second textile to be applied to NYC seats and backs.

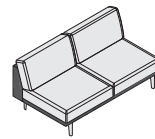

Club Chair
Plinth and Arms 4.5 yds
Seat and Back 3.2 yds

Two-Seat Sofa
Plinth and Arms 5.5 yds
Seats and Backs 5.5 yds

Three-Seat Sofa
Plinth and Arms 6.5 yds
Seats and Backs 8.5 yds

3. Leg Choice

- Leg Choice**

C1 ALUMINUM LEGS WITH ADJUSTABLE GLIDES

4. Leg Finish

- Standard Powder Coat**

BL	BLUE	NK	NICKEL
BM	BLACK MATTE	NV	NAVY
BR	BRASS	OR	ORANGE
BT	BLACK TWILIGHT	PY	PALE YELLOW
CP	CHAMPAGNE	RD	RED
DB	DARK BRONZE	RO	RED ORANGE
DG	DARK GRAY	RR	RUSTY RED
DP	DUSTY PINK	SB	SOFT BLUE
FG	FOREST GREEN	SD	SAND
LG	LIGHT GRAY	TC	TERRACOTTA
MG	MEADOW GREEN	TP	TAUPE
MK	MILK	TS	TEXTURED SLATE
MS	METALLIC SILVER	YL	YELLOW
- Polished Metal**

	1-Seat	2-Seat	3-Seat	
AL	POLISHED ALUMINUM/CHROME	+223	+223	+297

Chrome rails with polished aluminum legs.

5. Power

- Power**

Refer to power ordering steps on [page 7](#).

6. Options

- Options**

CT CONTRASTING THREAD

7. Upholstery

- Upholstery**

See [general information section](#) for details on textile program and COM/COL information.

Yardages provided are for non-directional fabrics that are applied railroaded. Directional fabrics may require additional yardage.

When specifying dual upholstery models, the higher of the two grades will determine price.

NYC

LOOSE: STAND ALONE SEATING, 4IN ARM

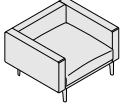
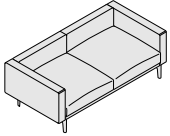
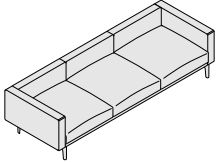
TITLE	SERIES	MODEL	STYLE	DIMENSIONS	YDG	SQFT	Textile Upholstery Grades										Leather Upholstery Grades									
							COM	COL	COM	A	B	COL	C	D	E	F	G	H	I	J	K	L	M	W	X	Y
Stand Alone Club Chair Loose 4in Arm No Back 	NY	11	6	B24	38W x 34.5D x 25.25H	6	90	4,051	4,559	4,834	5,102	5,377	5,653	5,957	6,259	6,615	7,077	7,629	8,182	8,723	9,276	6,185	6,760	8,975	9,801	10,987
Stand Alone Two-Seat Sofa Loose 4in Arm No Back 	NY	12	6	B24	68W x 34.5D x 25.25H	8.5	128	5,794	6,469	6,838	7,196	7,560	7,930	8,333	8,736	9,211	9,829	10,564	11,300	12,025	12,762	8,819	9,634	12,774	15,566	17,504
Stand Alone Three-Seat Sofa Loose 4in Arm No Back 	NY	13	6	B24	98W x 34.5D x 25.25H	11	173	7,537	8,466	8,973	9,463	9,969	10,474	11,028	11,585	12,236	13,084	14,096	15,107	16,103	17,117	11,613	12,713	16,947	20,752	23,374

To Order Select Below

1. Series/Model/Style/Arm

- NY116B24

NYC
Stand Alone, Club Chair
Loose, 4in Arm,
No Back
- NY126B24

NYC
Stand Alone, Two-Seat
Sofa, Loose, 4in Arm,
No Back
- NY136B24

NYC
Stand Alone, Three-Seat
Sofa, Loose, 4in Arm,
No Back

2. Upholstery Style

- Upholstery Style**

DF DUAL UPHOLSTERY

Dual upholstery option allows for a second textile to be applied to NYC seats and backs.

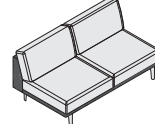

Club Chair
Plinth and Arms 4.5 yds
Seat 2.0 yds

Two-Seat Sofa
Plinth and Arms 5.5 yds
Seats 3.0 yds

Three-Seat Sofa
Plinth and Arms 6.5 yds
Seats 4.5 yds

3. Leg Choice

- Leg Choice**

C1 ALUMINUM LEGS WITH ADJUSTABLE GLIDES

4. Leg Finish

- Standard Powder Coat**

BL	BLUE	NK	NICKEL
BM	BLACK MATTE	NV	NAVY
BR	BRASS	OR	ORANGE
BT	BLACK TWILIGHT	PY	PALE YELLOW
CP	CHAMPAGNE	RD	RED
DB	DARK BRONZE	RO	RED ORANGE
DG	DARK GRAY	RR	RUSTY RED
DP	DUSTY PINK	SB	SOFT BLUE
FG	FOREST GREEN	SD	SAND
LG	LIGHT GRAY	TC	TERRACOTTA
MG	MEADOW GREEN	TP	TAUPE
MK	MILK	TS	TEXTURED SLATE
MS	METALLIC SILVER	YL	YELLOW
- Polished Metal**

	1-Seat	2-Seat	3-Seat
AL	POLISHED ALUMINUM/CHROME	+223	+223

Chrome rails with polished aluminum legs.

5. Power

- Power**

Refer to power ordering steps on [page 7](#).

6. Options

- Options**

CT CONTRASTING THREAD

7. Upholstery

- Upholstery**

See [general information section](#) for details on textile program and COM/COL information.

Yardages provided are for non-directional fabrics that are applied railroaded. Directional fabrics may require additional yardage.

When specifying dual upholstery models, the higher of the two grades will determine price.

NYC

LOOSE: STAND ALONE SEATING, 6IN ARM

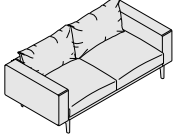
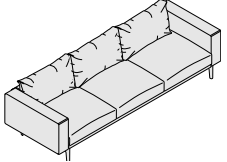
TITLE	SERIES	MODEL	STYLE	DIMENSIONS	YDG	SQFT	Textile Upholstery Grades										Leather Upholstery Grades									
							COM	COL	COM	A	B	C	D	E	F	G	H	I	J	K	L	M	W	X	Y	E1
Stand Alone Club Chair Loose 6in Arm Full Back Cushion 	NY	11	5	B26	42W x 34.5D x 31H	7	118	4,533	5,126	5,446	5,758	6,078	6,403	6,756	7,110	7,524	8,064	8,708	9,350	9,983	10,629	7,288	8,031	10,891	11,879	13,396
Stand Alone Two-Seat Sofa Loose 6in Arm Full Back Cushion 	NY	12	5	B26	72W x 34.5D x 31H	11	175	6,759	7,603	8,064	8,508	8,968	9,428	9,934	10,436	11,030	11,803	12,723	13,642	14,547	15,467	10,835	11,936	16,169	18,495	20,918
Stand Alone Three-Seat Sofa Loose 6in Arm Full Back Cushion 	NY	13	5	B26	102W x 34.5D x 31H	14	239	8,984	10,082	10,682	11,259	11,857	12,455	13,111	13,767	14,538	15,540	16,736	17,932	19,108	20,303	14,572	16,079	21,882	24,992	28,728

To Order Select Below

1. Series/Model/Style/Arm

- NY115B26

NYC
Stand Alone, Club Chair
Loose, 6in Arm,
Full Back Cushion
- NY125B26

NYC
Stand Alone, Two-Seat
Sofa, Loose, 6in Arm,
Full Back Cushion
- NY135B26

NYC
Stand Alone, Three-Seat
Sofa, Loose, 6in Arm,
Full Back Cushion

2. Upholstery Style

- Upholstery Style**

DF DUAL UPHOLSTERY

Dual upholstery option allows for a second textile to be applied to NYC seats and backs.

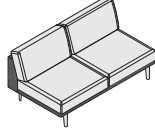

Club Chair
Plinth and Arms 4.5 yds
Seat and Back 3.2 yds

Two-Seat Sofa
Plinth and Arms 5.5 yds
Seats and Backs 5.5 yds

Three-Seat Sofa
Plinth and Arms 6.5 yds
Seats and Backs 8.5 yds

3. Leg Choice

- Leg Choice**

C1 ALUMINUM LEGS WITH ADJUSTABLE GLIDES

4. Leg Finish

- Standard Powder Coat**

BL	BLUE	NK	NICKEL
BM	BLACK MATTE	NV	NAVY
BR	BRASS	OR	ORANGE
BT	BLACK TWILIGHT	PY	PALE YELLOW
CP	CHAMPAGNE	RD	RED
DB	DARK BRONZE	RO	RED ORANGE
DG	DARK GRAY	RR	RUSTY RED
DP	DUSTY PINK	SB	SOFT BLUE
FG	FOREST GREEN	SD	SAND
LG	LIGHT GRAY	TC	TERRACOTTA
MG	MEADOW GREEN	TP	TAUPE
MK	MILK	TS	TEXTURED SLATE
MS	METALLIC SILVER	YL	YELLOW
- Polished Metal**

	1-Seat	2-Seat	3-Seat
AL	POLISHED ALUMINUM/CHROME	+223	+223 +297

Chrome rails with polished aluminum legs.

5. Power

- Power**

Refer to power ordering steps on [page 7](#).

6. Options

- Options**

CT CONTRASTING THREAD

7. Upholstery

- Upholstery**

See [general information section](#) for details on textile program and COM/COL information.

Yardages provided are for non-directional fabrics that are applied railroaded. Directional fabrics may require additional yardage.

When specifying dual upholstery models, the higher of the two grades will determine price.

NYC

LOOSE: STAND ALONE SEATING, 6IN ARM

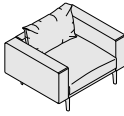
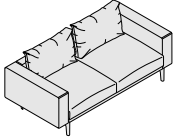
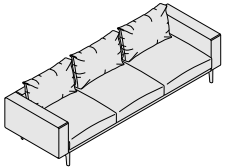
TITLE	SERIES	MODEL	STYLE	DIMENSIONS	COM	COL	Textile Upholstery Grades										Leather Upholstery Grades									
							YDG	SQFT	COM	A	B	C	D	E	F	G	H	I	J	K	L	M	W	X	Y	E1
Stand Alone Club Chair Loose 6in Arm Partial Back Cushion 	NY	11	4	B26	42W x 34.5D x 31H	7	118	4,533	5,126	5,446	5,758	6,078	6,403	6,756	7,110	7,524	8,064	8,708	9,350	9,983	10,629	7,288	8,031	10,891	11,879	13,396
Stand Alone Two-Seat Sofa Loose 6in Arm Partial Back Cushion 	NY	12	4	B26	72W x 34.5D x 31H	11	175	6,759	7,603	8,064	8,508	8,968	9,428	9,934	10,436	11,030	11,803	12,723	13,642	14,547	15,467	10,835	11,936	16,169	18,495	20,918
Stand Alone Three-Seat Sofa Loose 6in Arm Partial Back Cushion 	NY	13	4	B26	102W x 34.5D x 31H	14	239	8,984	10,082	10,682	11,259	11,857	12,455	13,111	13,767	14,538	15,540	16,736	17,932	19,108	20,303	14,572	16,079	21,882	24,992	28,728

To Order Select Below

1. Series/Model/Style/Arm

- NY114B26

NYC
Stand Alone, Club Chair
Loose, 6in Arm,
Partial Back Cushion
- NY124B26

NYC
Stand Alone, Two-Seat
Sofa, Loose, 6in Arm,
Partial Back Cushion
- NY134B26

NYC
Stand Alone, Three-Seat
Sofa, Loose, 6in Arm,
Partial Back Cushion

2. Upholstery Style

- Upholstery Style**

DF DUAL UPHOLSTERY

Dual upholstery option allows for a second textile to be applied to NYC seats and backs.

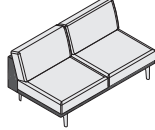

Club Chair
Plinth and Arms 4.5 yds
Seat and Back 3.2 yds

Two-Seat Sofa
Plinth and Arms 5.5 yds
Seats and Backs 5.5 yds

Three-Seat Sofa
Plinth and Arms 6.5 yds
Seats and Backs 8.5 yds

3. Leg Choice

- Leg Choice**

C1 ALUMINUM LEGS WITH ADJUSTABLE GLIDES

4. Leg Finish

- Standard Powder Coat**

BL	BLUE	NK	NICKEL
BM	BLACK MATTE	NV	NAVY
BR	BRASS	OR	ORANGE
BT	BLACK TWILIGHT	PY	PALE YELLOW
CP	CHAMPAGNE	RD	RED
DB	DARK BRONZE	RO	RED ORANGE
DG	DARK GRAY	RR	RUSTY RED
DP	DUSTY PINK	SB	SOFT BLUE
FG	FOREST GREEN	SD	SAND
LG	LIGHT GRAY	TC	TERRACOTTA
MG	MEADOW GREEN	TP	TAUPE
MK	MILK	TS	TEXTURED SLATE
MS	METALLIC SILVER	YL	YELLOW
- Polished Metal**

	1-Seat	2-Seat	3-Seat	
AL	POLISHED ALUMINUM/CHROME	+223	+223	+297

Chrome rails with polished aluminum legs.

5. Power

- Power**

Refer to power ordering steps on [page 7](#).

6. Options

- Options**

CT CONTRASTING THREAD

7. Upholstery

- Upholstery**

See [general information section](#) for details on textile program and COM/COL information.

Yardages provided are for non-directional fabrics that are applied railroaded. Directional fabrics may require additional yardage.

When specifying dual upholstery models, the higher of the two grades will determine price.

NYC

LOOSE: STAND ALONE SEATING, 6IN ARM

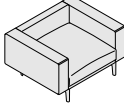
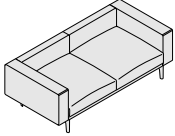
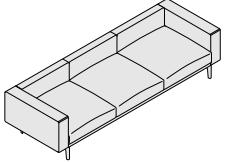
TITLE	SERIES	MODEL	STYLE	DIMENSIONS	YDG	SQFT	Textile Upholstery Grades										Leather Upholstery Grades									
							COM	COL	COM	A	B	C	D	E	F	G	H	I	J	K	L	M	W	X	Y	E1
Stand Alone Club Chair Loose 6in Arm No Back 	NY	11	6	B26	42W x 34.5D x 25.25H	6	96	4,051	4,559	4,834	5,102	5,377	5,653	5,957	6,259	6,615	7,077	7,629	8,182	8,723	9,276	6,292	6,899	9,225	10,120	11,372
Stand Alone Two-Seat Sofa Loose 6in Arm No Back 	NY	12	6	B26	72W x 34.5D x 25.25H	8.5	134	5,794	6,469	6,838	7,196	7,560	7,930	8,333	8,736	9,211	9,829	10,564	11,300	12,025	12,762	8,927	9,771	13,023	15,908	17,913
Stand Alone Three-Seat Sofa Loose 6in Arm No Back 	NY	13	6	B26	102W x 34.5D x 25.25H	11	179	7,537	8,466	8,973	9,463	9,969	10,474	11,028	11,585	12,236	13,084	14,096	15,107	16,103	17,117	11,721	12,852	17,195	21,092	23,785

To Order Select Below

1. Series/Model/Style/Arm

- NY116B26

NYC
Stand Alone, Club Chair
Loose, 6in Arm,
No Back
- NY126B26

NYC
Stand Alone, Two-Seat
Sofa, Loose, 6in Arm,
No Back
- NY136B26

NYC
Stand Alone, Three-Seat
Sofa, Loose, 6in Arm,
No Back

2. Upholstery Style

- Upholstery Style**

DF DUAL UPHOLSTERY

Dual upholstery option allows for a second textile to be applied to NYC seats and backs.

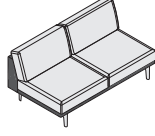

Club Chair
Plinth and Arms 4.5 yds
Seat 2.0 yds

Two-Seat Sofa
Plinth and Arms 5.5 yds
Seats 3.0 yds

Three-Seat Sofa
Plinth and Arms 6.5 yds
Seats 4.5 yds

3. Leg Choice

- Leg Choice**

C1 ALUMINUM LEGS WITH ADJUSTABLE GLIDES

4. Leg Finish

- Standard Powder Coat**

BL	BLUE	NK	NICKEL
BM	BLACK MATTE	NV	NAVY
BR	BRASS	OR	ORANGE
BT	BLACK TWILIGHT	PY	PALE YELLOW
CP	CHAMPAGNE	RD	RED
DB	DARK BRONZE	RO	RED ORANGE
DG	DARK GRAY	RR	RUSTY RED
DP	DUSTY PINK	SB	SOFT BLUE
FG	FOREST GREEN	SD	SAND
LG	LIGHT GRAY	TC	TERRACOTTA
MG	MEADOW GREEN	TP	TAUPE
MK	MILK	TS	TEXTURED SLATE
MS	METALLIC SILVER	YL	YELLOW
- Polished Metal**

	1-Seat	2-Seat	3-Seat	
AL	POLISHED ALUMINUM/CHROME	+223	+223	+297

Chrome rails with polished aluminum legs.

5. Power

- Power**

Refer to power ordering steps on [page 7](#).

6. Options

- Options**

CT CONTRASTING THREAD

7. Upholstery

- Upholstery**

See [general information section](#) for details on textile program and COM/COL information.

Yardages provided are for non-directional fabrics that are applied railroaded. Directional fabrics may require additional yardage.

When specifying dual upholstery models, the higher of the two grades will determine price.

NYC

LOOSE: STAND ALONE SEATING, 9IN ARM

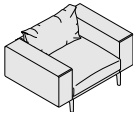
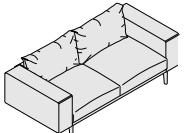
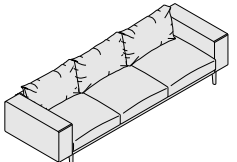
TITLE	SERIES	MODEL	STYLE	DIMENSIONS	YDG	SQFT	Textile Upholstery Grades										Leather Upholstery Grades									
							COM	COL	COM	A	B	C	D	E	F	G	H	I	J	K	L	M	W	X	Y	E1
Stand Alone Club Chair Loose 9in Arm Full Back Cushion 	NY	11	5	B29	48W x 34.5D x 31H	9	122	4,533	5,293	5,708	6,108	6,522	6,936	7,389	7,845	8,378	9,072	9,898	10,729	11,543	12,371	7,396	8,167	11,138	12,200	13,780
Stand Alone Two-Seat Sofa Loose 9in Arm Full Back Cushion 	NY	12	5	B29	78W x 34.5D x 31H	13	179	6,759	7,772	8,323	8,858	9,411	9,962	10,566	11,173	11,885	12,810	13,916	15,017	16,103	17,208	10,943	12,073	16,416	18,814	21,303
Stand Alone Three-Seat Sofa Loose 9in Arm Full Back Cushion 	NY	13	5	B29	108W x 34.5D x 31H	17	243	8,984	10,251	10,942	11,610	12,300	12,989	13,746	14,503	15,392	16,550	17,929	19,308	20,666	22,045	14,680	16,215	22,131	25,321	29,113

To Order Select Below

1. Series/Model/Style/Arm



NY115B29
NYC
Stand Alone, Club Chair
Loose, 9in Arm,
Full Back Cushion

NY125B29
NYC
Stand Alone, Two-Seat
Sofa, Loose, 9in Arm,
Full Back Cushion

NY135B29
NYC
Stand Alone, Three-Seat
Sofa, Loose, 9in Arm,
Full Back Cushion

2. Upholstery Style



DF DUAL UPHOLSTERY
 Dual upholstery option allows for a second textile to be applied to NYC seats and backs.

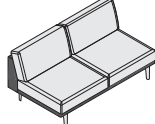

Club Chair
 Plinth and Arms 7.0 yds
 Seat and Back 3.2 yds

Two-Seat Sofa
 Plinth and Arms 7.5 yds
 Seats and Backs 5.5 yds

Three-Seat Sofa
 Plinth and Arms 9.0 yds
 Seats and Backs 8.5 yds

3. Leg Choice

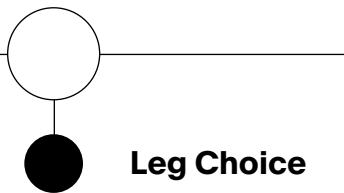

ALUMINUM LEGS WITH ADJUSTABLE GLIDES
 C1

4. Leg Finish



Standard Powder Coat

BL	BLUE
BM	BLACK MATTE
BR	BRASS
BT	BLACK TWILIGHT
CP	CHAMPAGNE
DB	DARK BRONZE
DG	DARK GRAY
DP	DUSTY PINK
FG	FOREST GREEN
LG	LIGHT GRAY
MG	MEADOW GREEN
MK	MILK
MS	METALLIC SILVER

Polished Metal

	1-Seat	2-Seat	3-Seat	
AL	POLISHED ALUMINUM/CHROME	+223	+223	+297

Chrome rails with polished aluminum legs.

5. Power

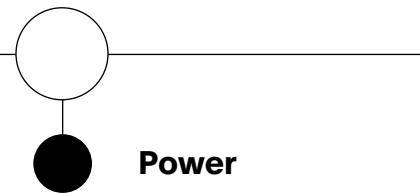

Power
 Refer to power ordering steps on [page 7](#).

6. Options



Options
 CT CONTRASTING THREAD

7. Upholstery



See general information section for details on textile program and COM/COL information.

Yardages provided are for non-directional fabrics that are applied railroaded. Directional fabrics may require additional yardage.

When specifying dual upholstery models, the higher of the two grades will determine price.

NYC

LOOSE: STAND ALONE SEATING, 9IN ARM

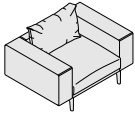
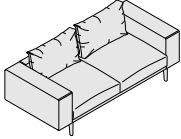
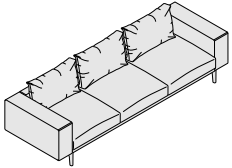
TITLE	SERIES	MODEL	STYLE	DIMENSIONS	YDG	SQFT	Textile Upholstery Grades										Leather Upholstery Grades									
							COM	COL	COM	A	B	C	D	E	F	G	H	I	J	K	L	M	W	X	Y	E1
Stand Alone Club Chair Loose 9in Arm Partial Back Cushion 	NY	11	4	B29	48W x 34.5D x 31H	9	122	4,533	5,293	5,708	6,108	6,522	6,936	7,389	7,845	8,378	9,072	9,898	10,729	11,543	12,371	7,396	8,167	11,138	12,200	13,780
Stand Alone Two-Seat Sofa Loose 9in Arm Partial Back Cushion 	NY	12	4	B29	78W x 34.5D x 31H	13	179	6,759	7,772	8,323	8,858	9,411	9,962	10,566	11,173	11,885	12,810	13,916	15,017	16,103	17,208	10,943	12,073	16,416	18,814	21,303
Stand Alone Three-Seat Sofa Loose 9in Arm Partial Back Cushion 	NY	13	4	B29	108W x 34.5D x 31H	17	243	8,984	10,251	10,942	11,610	12,300	12,989	13,746	14,503	15,392	16,550	17,929	19,308	20,666	22,045	14,680	16,215	22,131	25,321	29,113

To Order Select Below

1. Series/Model/Style/Arm



NY114B29
NYC
Stand Alone, Club Chair
Loose, 9in Arm,
Partial Back Cushion

NY124B29
NYC
Stand Alone, Two-Seat
Sofa, Loose, 9in Arm,
Partial Back Cushion

NY134B29
NYC
Stand Alone, Three-Seat
Sofa, Loose, 9in Arm,
Partial Back Cushion

2. Upholstery Style

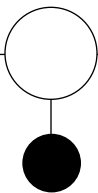

Upholstery Style
 DF DUAL UPHOLSTERY
 Dual upholstery option allows for a second textile to be applied to NYC seats and backs.

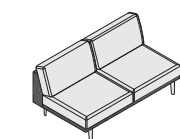

Club Chair
 Plinth and Arms 7.0 yds
 Seat and Back 3.2 yds

Two-Seat Sofa
 Plinth and Arms 7.5 yds
 Seats and Backs 5.5 yds

Three-Seat Sofa
 Plinth and Arms 9.0 yds
 Seats and Backs 8.5 yds

3. Leg Choice

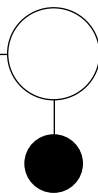

Leg Choice
 ALUMINUM LEGS WITH ADJUSTABLE GLIDES
 C1

4. Leg Finish

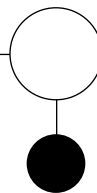

Standard Powder Coat

BL	BLUE	NK	NICKEL
BM	BLACK MATTE	NV	NAVY
BR	BRASS	OR	ORANGE
BT	BLACK TWILIGHT	PY	PALE YELLOW
CP	CHAMPAGNE	RD	RED
DB	DARK BRONZE	RO	RED ORANGE
DG	DARK GRAY	RR	RUSTY RED
DP	DUSTY PINK	SB	SOFT BLUE
FG	FOREST GREEN	SD	SAND
LG	LIGHT GRAY	TC	TERRACOTTA
MG	MEADOW GREEN	TP	TAUPE
MK	MILK	TS	TEXTURED SLATE
MS	METALLIC SILVER	YL	YELLOW

Polished Metal

	1-Seat	2-Seat	3-Seat	
AL	POLISHED ALUMINUM/CHROME	+223	+223	+297

Chrome rails with polished aluminum legs.

5. Power

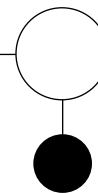

Power
 Refer to power ordering steps on [page 7](#).

6. Options

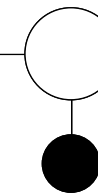

Options
 CT CONTRASTING THREAD

7. Upholstery

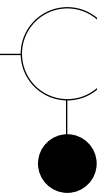

Upholstery
 See [general information section](#) for details on textile program and COM/COL information.

Yardages provided are for non-directional fabrics that are applied railroaded. Directional fabrics may require additional yardage.

When specifying dual upholstery models, the higher of the two grades will determine price.

NYC

LOOSE: STAND ALONE SEATING, 9IN ARM

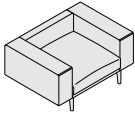
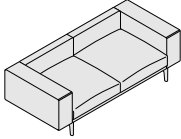
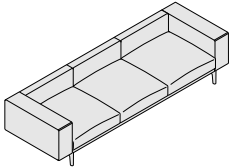
TITLE	SERIES	MODEL	STYLE	DIMENSIONS	COM	COL	Textile Upholstery Grades													Leather Upholstery Grades						
							YDG	SQFT	COM	A	B	C	D	E	F	G	H	I	J	K	L	M	W	X	Y	E1
Stand Alone Club Chair Loose 9in Arm No Back 	NY	11	6	B29	48W x 34.5D x 25.25H	8	100	4,051	4,726	5,094	5,452	5,818	6,187	6,591	6,994	7,469	8,085	8,820	9,557	10,281	11,018	6,401	7,034	9,472	10,438	11,757
Stand Alone Two-Seat Sofa Loose 9in Arm No Back 	NY	12	6	B29	78W x 34.5D x 25.25H	11	138	5,794	6,639	7,099	7,544	8,004	8,464	8,968	9,472	10,065	10,839	11,759	12,677	13,581	14,503	9,034	9,908	13,271	16,245	18,324
Stand Alone Three-Seat Sofa Loose 9in Arm No Back 	NY	13	6	B29	108W x 34.5D x 25.25H	13	183	7,537	8,635	9,236	9,812	10,411	11,008	11,666	12,320	13,092	14,094	15,291	16,486	17,662	18,856	11,828	12,987	17,444	21,434	24,195

To Order Select Below

1. Series/Model/Style/Arm

- NY116B29

NYC
Stand Alone, Club Chair
Loose, 6in Arm,
No Back
- NY126B29

NYC
Stand Alone, Two-Seat
Sofa, Loose, 6in Arm,
No Back
- NY136B29

NYC
Stand Alone, Three-Seat
Sofa, Loose, 6in Arm,
No Back

2. Upholstery Style

- Upholstery Style**

DF DUAL UPHOLSTERY

Dual upholstery option allows for a second textile to be applied to NYC seats and backs.

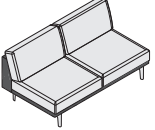

Club Chair
Plinth and Arms 7.0 yds
Seat 2.0 yds

Two-Seat Sofa
Plinth and Arms 7.5 yds
Seats 3.0 yds

Three-Seat Sofa
Plinth and Arms 9.0 yds
Seats 4.5 yds

3. Leg Choice

- Leg Choice**

C1 ALUMINUM LEGS WITH ADJUSTABLE GLIDES

4. Leg Finish

- Standard Powder Coat**

BL	BLUE	NK	NICKEL
BM	BLACK MATTE	NV	NAVY
BR	BRASS	OR	ORANGE
BT	BLACK TWILIGHT	PY	PALE YELLOW
CP	CHAMPAGNE	RD	RED
DB	DARK BRONZE	RO	RED ORANGE
DG	DARK GRAY	RR	RUSTY RED
DP	DUSTY PINK	SB	SOFT BLUE
FG	FOREST GREEN	SD	SAND
LG	LIGHT GRAY	TC	TERRACOTTA
MG	MEADOW GREEN	TP	TAUPE
MK	MILK	TS	TEXTURED SLATE
MS	METALLIC SILVER	YL	YELLOW
- Polished Metal**

	1-Seat	2-Seat	3-Seat
AL	POLISHED ALUMINUM/CHROME	+223	+223

Chrome rails with polished aluminum legs.

5. Power

- Power**

Refer to power ordering steps on [page 7](#).

6. Options

- Options**

CT CONTRASTING THREAD

7. Upholstery

- Upholstery**

See [general information section](#) for details on textile program and COM/COL information.

Yardages provided are for non-directional fabrics that are applied railroaded. Directional fabrics may require additional yardage.

When specifying dual upholstery models, the higher of the two grades will determine price.

NYC

LOOSE: STAND ALONE BENCHES

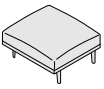
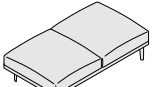
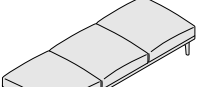
TITLE	SERIES	MODEL	STYLE	DIMENSIONS	COM	COL	Textile Upholstery Grades										Leather Upholstery Grades								
							YDG	SQFT	COM	A	B	C	D	E	F	G	H	I	J	K	L	M	W	X	Y
Stand Alone One-Seat Bench Loose 	NY	01	6	30W x 33.5D x 17.5H	3	58	2,748	3,007	3,148	3,285	3,429	3,570	3,725	3,883	4,065	4,305	4,586	4,871	5,150	5,434	3,988	4,323	5,450	5,986	6,905
Stand Alone Two-Seat Bench Loose 	NY	02	6	60W x 33.5D x 17.5H	5.5	115	3,357	3,793	4,028	4,257	4,494	4,730	4,990	5,248	5,553	5,950	6,424	6,899	7,363	7,836	5,526	6,099	8,071	8,990	10,671
Stand Alone Three-Seat Bench Loose 	NY	03	6	90W x 33.5D x 17.5H	7.5	173	4,881	5,492	5,823	6,143	6,474	6,805	7,168	7,532	7,960	8,513	9,176	9,840	10,491	11,154	8,036	8,869	11,738	13,071	15,519

To Order Select Below

1. Series/Model/Style

- NY016
NYC Stand Alone, One-Seat Bench, Loose
- NY026
NYC Stand Alone, Two-Seat Bench, Loose
- NY036
NYC Stand-Alone, Three-Seat Bench, Loose

2. Upholstery Style

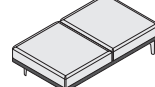
- Upholstery Style**
DF DUAL UPHOLSTERY
Dual upholstery option allows for a second textile to be applied to NYC seats and backs.

- One-Seat Stand Alone Bench**
Plinth 1.5 yds
Seat 2.5 yds
- Two-Seat Stand Alone Bench**
Plinth 2.0 yds
Seats 4.0 yds
- Three-Seat Stand Alone Bench**
Plinth 2.0 yds
Seats 5.5 yds

3. Leg Choice

- Leg Choice**
ALUMINUM LEGS WITH ADJUSTABLE GLIDES
C1

4. Leg Finish

- Standard Powder Coat**

BL	BLUE	NK	NICKEL
BM	BLACK MATTE	NV	NAVY
BR	BRASS	OR	ORANGE
BT	BLACK TWILIGHT	PY	PALE YELLOW
CP	CHAMPAGNE	RD	RED
DB	DARK BRONZE	RO	RED ORANGE
DG	DARK GRAY	RR	RUSTY RED
DP	DUSTY PINK	SB	SOFT BLUE
FG	FOREST GREEN	SD	SAND
LG	LIGHT GRAY	TC	TERRACOTTA
MG	MEADOW GREEN	TP	TAUPE
MK	MILK	TS	TEXTURED SLATE
MS	METALLIC SILVER	YL	YELLOW
- Polished Metal**

	1-Seat	2-Seat	3-Seat	
AL	POLISHED ALUMINUM/CHROME	+223	+223	+297

Chrome rails with polished aluminum legs.

5. Power

- Power**
Refer to power ordering steps on [page 7](#).

6. Options

- Options**
CT CONTRASTING THREAD

7. Upholstery

- Upholstery**
See [general information section](#) for details on textile program and COM/COL information.

Yardages provided are for non-directional fabrics that are applied railroaded. Directional fabrics may require additional yardage.

When specifying dual upholstery models, the higher of the two grades will determine price.

NYC

MODULAR ARMS

TITLE	SERIES	MODEL	STYLE	DIMENSIONS	COM	COL	Textile Upholstery Grades													Leather Upholstery Grades						
							YDG	SQFT	COM	A	B	C	D	E	F	G	H	I	J	K	L	M	W	X	Y	E1
4inch Arm																										
	NY	24		4W x 33.5D x 16.5H	2.5	17	486	655	748	836	929	1,020	1,121	1,223	1,342	1,493	1,678	1,863	2,043	2,227	935	1,076	1,433	1,644	2,031	
6inch Arm																										
	NY	26		6W x 33.5D x 16.5H	2.5	20	486	655	748	836	929	1,020	1,121	1,223	1,342	1,493	1,678	1,863	2,043	2,227	977	1,131	1,520	1,749	2,171	
9inch Arm																										
	NY	29		9W x 33.5D x 16.5H	2.5	22	486	655	748	836	929	1,020	1,121	1,223	1,342	1,493	1,678	1,863	2,043	2,227	1,035	1,206	1,642	1,898	2,370	

To Order Select Below

1. Series/Model

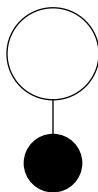

NY24
**NYC
4in Arm**

NY26

**NYC
6in Arm**

NY29

**NYC
9in Arm**

2. Arm Orientation

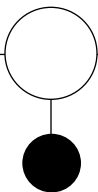

Arm Orientation

L LEFT ORIENTATION WHEN SEATED
R RIGHT ORIENTATION WHEN SEATED

3. Options

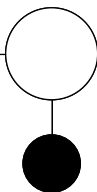

Options

CT CONTRASTING THREAD

4. Upholstery

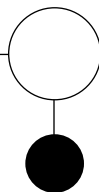

Upholstery

See general information section for details on textile program and COM/COL information.

NYC

TABLES

Customer's Own Top

TITLE	SERIES	MODEL	STYLE	DIMENSIONS	COT	CS51	CS52	CS65	CS96
Modular 2/3 In-line Table	NY	53		20W x 33.5D x 11.5H	929	3,209	3,209	3,672	5,526
Modular Full In-line Table	NY	51		33.5W x 33.5D x 11.5H	1,083	5,675	5,675	6,602	9,384
Modular Corner In-line Table	NY	55		34.5W x 34.5D x 11.5H	1,083	5,675	5,675	6,602	9,384
Stand Alone Bench Corner Table	NY	57		33.5W x 33.5D x 11.5H	1,083	5,675	5,675	6,602	9,384

To Order Select Below

1. Series/Model/Style

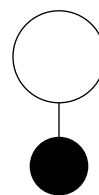

NY53
NYC Modular 2/3 In-line Table

NY51
NYC Modular Full In-line Table

NY055
NYC Modular Corner In-line Table

NY057
NYC Stand Alone Bench Corner Table

2. Top

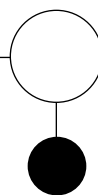

Caesarstone

CS51 JET BLACK
CS52 SLEEK CONCRETE
CS65 PURE WHITE
CS96 STATUARIO NUVO

Customer's Own Top

COT CUSTOMER'S OWN TOP

Template for Customer's Own Top
Stylex will supply digital templates for all table styles, or you may request a physical template from Stylex Customer Service.

3. Leg Choice

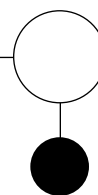

Leg Choice

C1 ALUMINUM LEGS WITH ADJUSTABLE GLIDES

4. Leg Finish

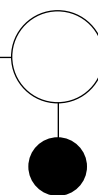

Standard Powder Coat







BL BLUE	NK NICKEL
BM BLACK MATTE	NV NAVY
BR BRASS	OR ORANGE
BT BLACK TWILIGHT	PY PALE YELLOW
CP CHAMPAGNE	RD RED
DB DARK BRONZE	RO RED ORANGE
DG DARK GRAY	RR RUSTY RED
DP DUSTY PINK	SB SOFT BLUE
FG FOREST GREEN	SD SAND
LG LIGHT GRAY	TC TERRACOTTA
MG MEADOW GREEN	TP TAUPE
MK MILK	TS TEXTURED SLATE
MS METALLIC SILVER	YL YELLOW

Polished Metal

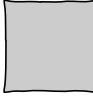
AL POLISHED ALUMINUM/CHROME **+247**

Chrome rails with polished aluminum legs.

NYC

TITLE	SERIES	MODEL	STYLE	DIMENSIONS	Textile Upholstery Grades											Leather Upholstery Grades									
					COM	COL	COM	A	B	COL	C	D	E	F	G	H	I	J	K	L	M	W	X	Y	E1
24 × 24in Throw Pillow 	NY	71		24 × 24	2	18	297	382	427	471	519	564	613	665	723	800	893	986	1,076	1,168	706	833	1,157	1,348	1,700
20 × 20in Throw Pillow 	NY	72		50 × 20	1	15	186	271	316	359	406	452	504	553	612	690	781	875	964	1,055	483	575	813	951	1,206
18 × 18in Throw Pillow 	NY	73		18 × 18	1	13	186	271	316	359	406	452	504	553	612	690	781	875	964	1,055	434	511	708	823	1,036
16 × 16in Throw Pillow 	NY	74		16 × 16	1	13	186	271	316	359	406	452	504	553	612	690	781	875	964	1,055	387	449	611	707	879
14 × 20in Throw Pillow 	NY	75		14 × 20	1	13	186	271	316	359	406	452	504	553	612	690	781	875	964	1,055	403	471	648	749	935
16 × 22in Throw Pillow 	NY	76		16 × 22	1	15	186	271	316	359	406	452	504	553	612	690	781	875	964	1,055	448	530	741	866	1,093
18in Round Throw Pillow 	NY	77		18 × 18	1	11	186	271	316	359	406	452	504	553	612	690	781	875	964	1,055	434	511	708	823	1,036

To Order Select Below

1. Series/Model

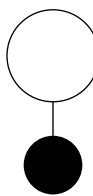

NY71	24 X 24 THROW PILLOW
NY72	20 X 20 THROW PILLOW
NY73	18 X 18 THROW PILLOW
NY74	16 X 16 THROW PILLOW
NY75	14 X 20 THROW PILLOW
NY76	16 X 22 THROW PILLOW
NY77	18IN ROUND THROW PILLOW

2. Cushion Sewing Pattern

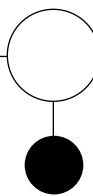

Cushion Sewing Pattern

1	GUSSET (STYLE USED ON LOOSE BACK CUSHIONS)
2	PINCH (OVERSIZED SEAM ON SIDES)
3	PANEL (TRADITIONAL LOW-PROFILE SEAM)



Gusset
Not available on Round Pillows

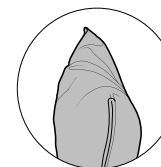

Pinch

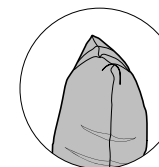

Panel

NYC throw cushions are filled with a down and feather blend.

3. Options

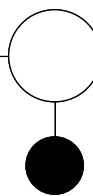

Options

CT	CONTRASTING THREAD
----	--------------------

Contrasting thread is only available on pillows in the pinch style.

4. Upholstery

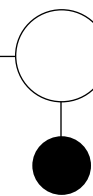

Upholstery

See general information section for details on textile program and COM/COL information.

stylex

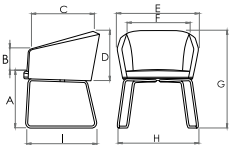
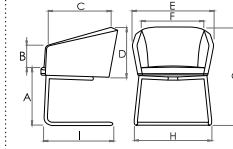
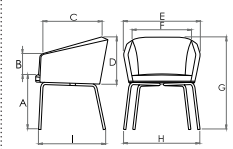
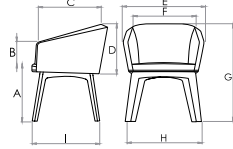
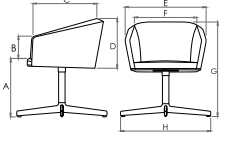
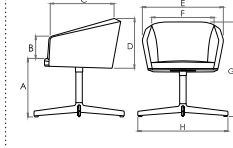
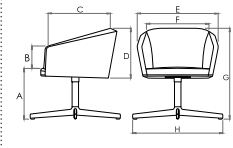
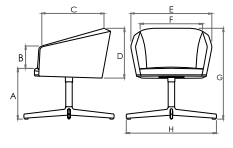
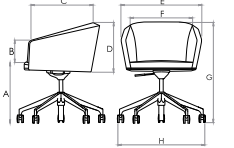

Ridge Guest

PRICE LIST
Effective November 01, 2023

Dimensions / Overview	Radius Sled Frame	Cantilever Sled Frame	Four-Leg Frame	Wood Frame	General Information
	Guest Height Chair				
A. Seat Height B. Arm Height C. Seat Depth D. Back Height E. Overall Width of Arms F. Seat Width G. Overall Height H. Overall Width Base I. Overall Depth	A. 18" B. 7" C. 20" D. 16" E. 25" F. 20" G. 30" H. 25" I. 22" 	A. 18" B. 7" C. 20" D. 16" E. 25" F. 20" G. 30" H. 24" I. 21" 	A. 18" B. 7" C. 20" D. 16" E. 25" F. 20" G. 30" H. 25" I. 22" 	A. 18" B. 7" C. 20" D. 16" E. 25" F. 20" G. 30" H. 23" I. 21" 	<p>Design Aodh O Donnell</p> <p>Construction – Arms and Back The upper portion of each Ridge Guest chair incorporates a rigid polyurethane interior over-molded with soft, plant-based polyurethane molded foam to create a unitized construction. Upholstery covers are pulled over this structure and held in place with waterbased adhesive.</p> <p>Construction – Seat The seat utilizes 5/8" plywood with a molded foam, high-density topper that is 2.25" thick.</p>
	Fixed Height Swivel-18" High	Fixed Height Swivel Return-18" High	Fixed Height Swivel-16" High	Fixed Height Swivel Return-16" High	
	Guest Height Chair		Lounge Height Chair		
A. Seat Height B. Arm Height C. Seat Depth D. Back Height E. Overall Width of Arms F. Seat Width G. Overall Height H. Overall Width/Depth Base	A. 18" B. 7" C. 20" D. 16" E. 25" F. 20" G. 30" H. 28" 	A. 18" B. 7" C. 20" D. 16" E. 25" F. 20" G. 30" H. 28" 	A. 16.5" B. 7" C. 20" D. 16" E. 25" F. 20" G. 28" H. 28" 	A. 16.5" B. 7" C. 20" D. 16" E. 25" F. 20" G. 28" H. 28" 	<p>Construction – Bases Cantilevered sled base frames are 1", 13-gauge steel tube. Radius sled and four-leg frames are 5/8", 16-gauge steel tube. Both 4-blade and 5-blade bases are cast aluminum.</p> <p>Wood, 4-leg bases are produced from white oak or maple, depending on the option selected.</p> <p>All sled base components may be ordered in bright chrome or one of our powder coat finishes. The 4-blade bases may be either polished aluminum or painted. 5-blade swivel bases are either polished aluminum or painted, but painted 5-blade bases always utilize chrome cylinders.</p> <p>Glides Glides are either plastic or plastic with felt pads.</p> <p>Use Designed for indoor use only.</p> <p>Testing Manufactured to comply with ANSI/BIFMA x5.1 General Office Chair tests.</p> <p>Environment Greenguard Certified.</p>
	Adjustable Height Swivel				
	Adjustable Height Chair				
A. Seat Height B. Arm Height C. Seat Depth D. Back Height E. Overall Width of Arms F. Seat Width G. Overall Height H. Overall Width/Depth Base	A. 15.4" - 20.4" B. 7" C. 20" D. 16" E. 25" F. 20" G. 27.2" - 32.2" H. 27" 				

Ridge Guest

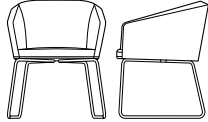
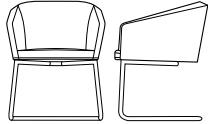
Upholstered Shell
Metal Base Frames

Series	Shell	Height	Base	Description / Finish	Ydg.	Sq. ft.	C.O.M. / C.O.L. Fabric Upholstery Grades											Leather Upholstery Grades					
							C.O.M.	A	B	C	D	E	F	G	H	I	J	K	W	X	Y	E1	E2
	Radius Sled Frame			Upholstered Shell with Radius Sled Frame, 18" Guest Height Seat																			
RG	2	18	1	Standard Powder	2.8	36	1,683	1,918	2,050	2,172	2,297	2,427	2,568	2,709	2,874	3,089	3,344	3,600	2,683	2,995	3,973	4,258	5,363
	Cantilever Sled Frame			Upholstered Shell with Cantilever Sled Frame, 18" Guest Height Seat																			
RG	2	18	3	Standard Powder	2.8	36	1,760	1,996	2,124	2,248	2,377	2,504	2,645	2,785	2,951	3,167	3,419	3,677	2,759	3,070	4,054	4,337	5,443
	Four Leg Frame			Upholstered Shell with Four Leg Frame 18" Guest Height Seat																			
RG	2	18	4	Standard Powder	2.8	36	1,683	1,918	2,050	2,172	2,297	2,427	2,568	2,709	2,874	3,089	3,344	3,600	2,683	2,995	3,973	4,258	5,363

To Order Follow Steps 1-7

1. Series / Shell / Height

RG218

Fully Upholstered Guest Height Chair

2. Base

Base

- Radius Sled Frame Guest Height 5/8" Steel Tube
- Cantilever Sled Frame Guest Height 1" Reinforced Steel Tube
- Four Leg Frame Guest Height 3/4" Steel Tube

3. Dual Upholstery Options

Dual Upholstery Options

The Dual Upholstery options allow for two fabrics in two different combinations. When specifying in-graded fabrics, please apply the higher of the two grades.

DF1 Second Fabric On Seat

Seat	Arms
Inside Back	Inside Back
Outside Back	Outside Back
Yds.	Yds.
RG2 0.8	2.3

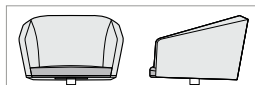

DF2 Second Fabric On Outside Back

Seat	Outside Back
Inside Back	Inside Back
Arms	Arms
Yds.	Yds.
RG2 1.9	1.2

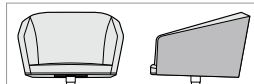

4. Other Options

CT

Contrasting Thread

5. Frame Finish Choices

Standard Power Paint

BL Blue	NK Nickel
BM Black Matte	NV Navy
BR Brass	OR Orange
BT Black Twilight	PY Pale Yellow
CP Champagne	RD Red
DB Dark Bronze	RO Red Orange
DG Dark Gray	RR Rusty Red
DP Dusty Pink	SB Soft Blue
FG Forest Green	SD Sand
LG Light Gray	TC Terracotta
MG Meadow Green	TP Taupe
MK Milk	TS Textured Slate
MS Metallic Silver	YL Yellow

CH Bright Chrome

+147

6. Glide Choice

Glides

- PG Plastic Glides
- FG Plastic Glides with Felt Pads
- *FG Glides only available on Radius Sled Frames

7. Cover

Fabrics are cut up the roll.

Ridge Guest may develop mild comfort wrinkles on the inside back and seat when specified with leather or fabrics that do not recover well.

Refer to Stylex swatch cards and separately published in-graded fabric program to determine grades.

See general information section in the main price list for CAL 133 information.

Ridge Guest

Upholstered Shell
Fixed-Height Swivel Bases

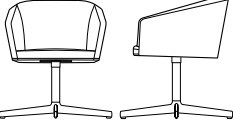
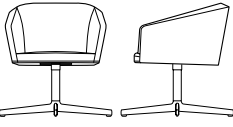
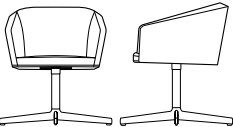
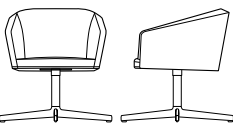
Series	Shell	Height	Base	Description / Finish	C.O.M. Ydg.	C.O.L. Sq. ft.	C.O.M / C.O.L. Fabric Upholstery Grades C.O.L.											Leather Upholstery Grades					
							C.O.M	A	B	C	D	E	F	G	H	I	J	K	W	X	Y	E1	E2
	Fixed-Height Swivel 18" Guest			Upholstered Shell, Fixed-Height Swivel, Four Blade Aluminum Base, 18" Guest	2.8	36	1,913	2,149	2,279	2,403	2,528	2,657	2,797	2,939	3,104	3,319	3,572	3,830	2,914	3,226	4,213	4,490	5,603
	Fixed-Height Swivel 16" Lounge			Upholstered Shell, Fixed-Height Swivel, Four Blade Aluminum Base, 16" Lounge	2.8	36	1,913	2,149	2,279	2,403	2,528	2,657	2,797	2,939	3,104	3,319	3,572	3,830	2,914	3,226	4,213	4,490	5,603
	Fixed-Height Swivel Return 18" Guest			Upholstered Shell, Fixed-Height 360 Degree Swivel Return, Four Blade Aluminum Base, 18" Guest	2.8	36	2,106	2,340	2,470	2,594	2,718	2,848	2,990	3,130	3,295	3,509	3,765	4,024	3,104	3,416	4,414	4,679	5,805
	Fixed-Height Swivel Return 16" Lounge			Upholstered Shell, Fixed-Height 360 Degree Swivel Return, Four Blade Aluminum Base, 16" Lounge	2.8	36	2,106	2,340	2,470	2,594	2,718	2,848	2,990	3,130	3,295	3,509	3,765	4,024	3,104	3,416	4,414	4,679	5,805

To Order Follow Steps 1-6

1. Series / Shell

RG

Series, Shell

218 Fully Upholstered Guest Height Chair

216 Fully Upholstered Lounge Height Chair

2. Base

Base

7 Fixed-Height Swivel Cast Aluminum Base

8 Fixed-Height Swivel 360 Degree Swivel Return Cast Aluminum Base

3. Dual Upholstery Options

Dual Upholstery Options

The Dual Upholstery options allow for two fabrics in two different combinations. When specifying in-graded fabrics, please apply the higher of the two grades.

DF1 Second Fabric On Seat

Seat	Arms
	Inside Back
	Outside Back
Yds.	Yds.
RG2 0.8	2.3

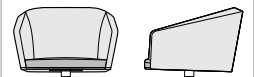

4. Other Options

Other Options

CT Contrasting Thread	+00
AG Adjustable Glides	+16

DF2 Second Fabric on Outside Back

Seat	Outside Back
Inside Back	Arms
Yds.	Yds.
RG2 1.9	1.2

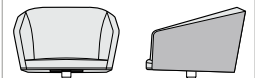

5. Frame Finish Choices

Standard Power Paint

BL Blue	NK Nickel
BM Black Matte	NV Navy
BR Brass	OR Orange
BT Black Twilight	PY Pale Yellow
CP Champagne	RD Red
DB Dark Bronze	RO Red Orange
DG Dark Gray	RR Rusty Red
DP Dusty Pink	SB Soft Blue
FG Forest Green	SD Sand
LG Light Gray	TC Terracotta
MG Meadow Green	TP Taupe
MK Milk	TS Textured Slate
MS Metallic Silver	YL Yellow

AL Polished Aluminum

6. Cover

Fabrics are cut up the roll.

Ridge Guest may develop mild comfort wrinkles on the inside back and seat when specified with leather or fabrics that do not recover well.

Refer to Stylex swatch cards and separately published in-graded fabric program to determine grades.

See general information section in the main price list for CAL 133 information.

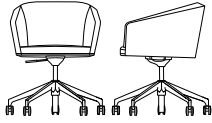
Series	Shell	Mech	Base	Description / Finish	C.O.M. Ydg.	C.O.L. Sq. ft.	C.O.M / C.O.L. Fabric Upholstery Grades C.O.L.											Leather Upholstery Grades					
							C.O.M	A	B	C	D	E	F	G	H	I	J	K	W	X	Y	E1	E2
	RG	2	40	9	Adjustable Height Swivel Upholstered Shell, Adjustable Height Swivel with Forward and Rearward Flex Five-Blade Aluminum Base with Casters	2.8	36																
								Standard Powder or Polished Aluminum	2,143	2,379	2,507	2,631	2,758	2,886	3,028	3,170	3,333	3,549	3,803	4,060	3,144	3,455	4,454

To Order Follow Steps 1-6

1. Series / Shell / mechanism

RG240

Fully Upholstered Adjustable Height Chair

2. Base

9

Adjustable Height Swivel with Forward and Rearward Flex. Five-Blade Aluminum Base with Casters

3. Dual Upholstery Options

DF1

Dual Upholstery Options
The Dual Upholstery options allow for two fabrics in two different combinations. When specifying in-graded fabrics, please apply the higher of the two grades.

DF1 Second Fabric on Seat

Seat	Arms
Inside Back	Outside Back
Yds.	Yds.
RG2 0.8	2.3

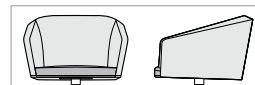

DF2 Second Fabric on Outside Back

Seat	Outside Back
Inside Back	
Arms	
Yds.	Yds.
RG2 1.9	1.2

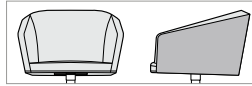

4. Other Options

CT

CT Contrasting Thread +00

Black Casters

BS Black Trim Soft Wheel	+46
CC Chrome Trim Casters	+107
CS Chrome Trim Soft Wheel	+132

Gray Casters

GC Gray Carpet Casters	+28
GS Gray Trim Soft Wheel	+57

Black carpet casters are used unless other caster option is chosen.

5. Frame Finish Choices

AL

Standard Power Paint*

BL Blue	NK Nickel
BM Black Matte	NV Navy
BR Brass	OR Orange
BT Black Twilight	PY Pale Yellow
CP Champagne	RD Red
DB Dark Bronze	RO Red Orange
DG Dark Gray	RR Rusty Red
DP Dusty Pink	SB Soft Blue
FG Forest Green	SD Sand
LG Light Gray	TC Terracotta
MG Meadow Green	TP Taupe
MK Milk	TS Textured Slate
MS Metallic Silver	YL Yellow

AL Polished Aluminum

* Cylinder color will match the frame if the frame finish is black matte, light gray, or milk. Otherwise, the cylinder will be chrome.

6. Cover

DF

Fabrics are cut up the roll.

Ridge Guest may develop mild comfort wrinkles on the inside back and seat when specified with leather or fabrics that do not recover well.

Refer to Stylex swatch cards and separately published in-graded fabric program to determine grades.

See general information section in the main price list for CAL 133 information.

Ridge Guest

Upholstered Shell
Wood Frame

Series	Shell	Height	Base	Description / Finish	C.O.M. Ydg.	C.O.L. Sq. ft.	C.O.M / C.O.L. Fabric Upholstery Grades											Leather Upholstery Grades						
							C.O.L.	A	B	C	D	E	F	G	H	I	J	K	W	X	Y	E1	E2	
Wood Frame				Upholstered Shell, Hardwood Leg Structure 18" Guest Height																				
RG	2	18	6	White Oak or Maple	2.8	36	2,373	2,608	2,736	2,860	2,989	3,115	3,257	3,397	3,564	3,777	4,032	4,291	3,372	3,683	4,695	4,949	6,086	

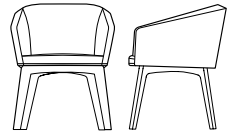

To Order Follow Steps 1-6

1. Series / Shell

RG218

Fully Upholstered Guest Height Chair

2. Base

6

Wood Four-Leg Frame Guest Height

3. Wood Finishes

81 White Oak +00
83 Natural Maple +00

Per order per color 20 chair minimum.

Please contact customer services for details.

4. Dual Upholstery Options

DF1 Second Fabric on Seat

Seat	Arms
Inside Back	Outside Back
Yds.	Yds.
RG2 0.8	2.3

5. Other Options

DF2 Second Fabric on Outside Back

Seat	Outside Back
Inside Back	
Arms	
Yds.	Yds.
RG2 1.9	1.2

6. Cover

CT Contrasting Thread +00

Fabrics are cut up the roll.

Ridge Guest may develop mild comfort wrinkles on the inside back and seat when specified with leather or fabrics that do not recover well.

Refer to Stylex swatch cards and separately published in-graded fabric program to determine grades.

See general information section in the main price list for CAL 133 information.

stylex

Sava

PRICE LIST
Effective January 17, 2024

General Information

GENERAL INFORMATION

Terms

Net 30 days from date of invoice.
FOB Delanco, NJ

Damaged Shipments

All Stylex products are carefully inspected before they are packed in sturdy cartons designed to satisfy shipping requirements. Stylex is not responsible for damage in shipment. The transportation company assumes responsibility for delivering products to you in good condition when the bill of lading is signed. You protect yourself by refusing shipments showing damage or shortage until transportation company has noted on the delivery sheet the extent of damage or shortage. Concealed damage should be reported to the carrier as soon as discovered, but not later than 15 days after receiving shipment.

Return/Restocking Policy

Return shipments will not be accepted unless specifically authorized by Stylex in writing. The Return Authorization number should be clearly marked on the carton. The customer returning Stylex products is responsible for return shipping costs. Merchandise must be returned unused. Returned merchandise is subject to a 35% restocking fee.

Specials/Customs

Modifications to standard products will be considered for large runs. Contact Stylex for more information.

Design Changes

In keeping with modern manufacturing advances, Stylex reserves the right to incorporate minor modifications and design changes in products without notice.

Cancellation Policy

No charge prior to production except for inventory specifically requisitioned to fulfill the particular order. After production has begun, only actual costs incurred, including labor and material, will be billed to the customer.

WARRANTY

Except as provided below, Stylex warrants exclusively to the original Purchaser of our product that all parts, under normal use and service, will be free from defects in workmanship and material for a period of ten (10) years from the date of purchase. "Normal use and service" means that the product will be used in a typical office environment for 40-45 hours per week.

This warranty is subject to the following limitations, exclusions and provisions:

Wood components of plywood stacking chairs
(such as Brooks and Welcome)
5 years

Upholstery
(including mesh used for Click, F4, Insight, and Zephyr Mesh)
3 years

SAVA Mesh
10 years

COM Upholstery
No warranty
Stylex makes every effort to ensure that the COM Upholstery it approves is suitable for the intended use. Nevertheless, we will not warrant, and assume no responsibility for, the durability or tailoring quality of any COM or COL. If you have any concerns about the ultimate appearance of any covering, please order an upholstered sample.

Painted Stack Chair Frames
No Warranty
We will not warrant the finish of painted stack chair frames against damage from stacking. We recommend ordering chrome frames for chairs that will be stacked.

Felt Glides
No warranty
Due to the different surfaces on which felt glides may be used, we cannot warrant their durability over time.

If this product fails during normal use and service within the applicable warranty period (other than through normal wear and tear), please send a description of the relevant part and the nature of the defect, together with proof of purchase of the product, to Stylex at: Customer Service. c/o Stylex, P.O. Box 5038, Delanco, NJ 08075. PLEASE DO NOT RETURN PARTS OR THE PRODUCT TO STYLEX UNLESS INSTRUCTED TO DO SO BY STYLEX. Stylex will, at its option, either repair or replace the product or the part found defective by Stylex completely without charge for materials or labor. Purchaser may be required (at the option of Stylex) to return to Stylex at Purchaser's expense any defective part with all freight or shipping charges prepaid. The foregoing warranty shall be void if the product has been altered or repaired (other than by Stylex). The warranty does not cover damage to the product caused by accident, neglect, misuse, abuse, modification to the product by anyone other than Stylex or damage caused by use of the product for a purpose other than that for which it was designed. This warranty extends only to the original Purchaser of the product.

No Other Warranties

This warranty is in lieu of all other warranties, expressed or implied, including, but not limited to, implied warranties of merchantability and fitness for a particular purpose. The rights and remedies provided herein are the exclusive rights and remedies of the original purchaser of the product.

No Liability For Damages

In no event shall Stylex or its suppliers be responsible or liable for any special, indirect, consequential, or incidental damages. In no event shall the liability of Stylex exceed the actual purchase price paid to Stylex for the product.

Out of Warranty Products

For all products no longer covered by our warranty, please refer to our Design for Durability and Upgradability Policy. Contact Customer Service if you would like to purchase any replaceable components to further extend the life of any Stylex seating product. This warranty applies to all Stylex products purchased on April 13, 2018, and thereafter.

PRODUCT TAKE BACK PROGRAM

At Stylex, responsible stewardship of our products extends beyond their initial use. Our Product Take Back Program provides a practical solution for the end of our products' intended life cycle.

Through our partnership with ANEW, a 501(c)(3) nonprofit organization, we offer clients a comprehensive take-back solution for surplus office furniture and materials, regardless of their condition. ANEW's mission aligns with ours—to connect surplus resources with non-profits, public agencies, and underserved communities, minimizing landfill impact and maximizing corporate social responsibility.

By repurposing surplus items, we strengthen community networks and reduce environmental impact. Stylex proudly supports ANEW, integrating this partnership into our strategic sales strategy since 2014. Learn more at www.anewfound.org.

Initiate a Product Take Back through ANEW by emailing Stylex at info@stylexdesign.com. For additional end-of-life recovery options, refer to our Product Disassembly Instructions and End of Life Recovery Options documents, available in the Resources section of each product on our website. Together, let's build a sustainable future.

FREIGHT PROGRAM

Stylex offers a Guaranteed Freight Program, which provides the purchaser the ability to determine shipping and handling charges at the time of order. Freight charges will be calculated as a percentage of the net product price and added to the invoice at the time of shipment. The continental United States has been divided into three zones. Please use the map below to determine the freight charges for the product's destination. There is a minimum freight charge of \$150.

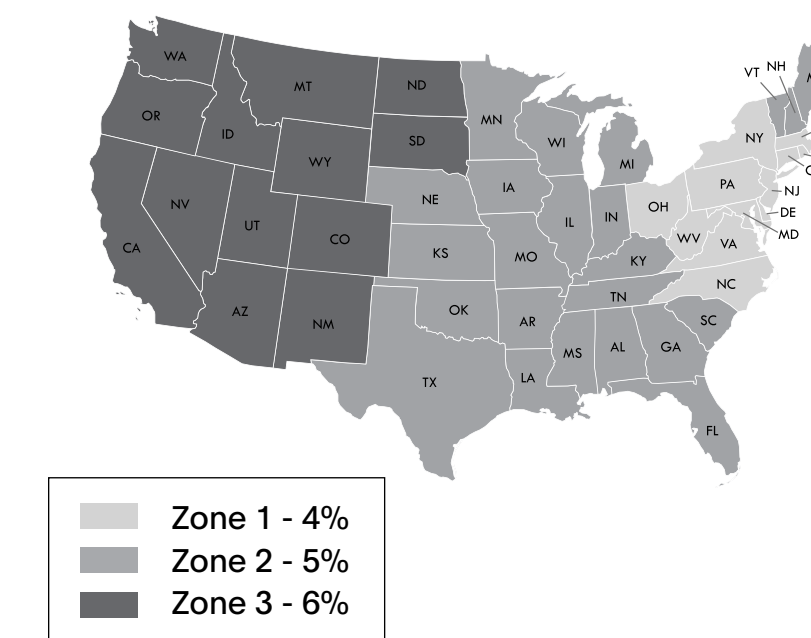

ZONE 1 - 4%

Connecticut
Delaware
New York
New Jersey
Maryland
Massachusetts
North Carolina
Ohio
Pennsylvania
Rhode Island
Virginia
Washington D.C.
West Virginia

ZONE 2 - 5%

Alabama
Arkansas
Canada, Ontario
Canada, Quebec
Florida
Georgia
Iowa
Illinois
Indiana
Kansas
Kentucky
Louisiana
Nebraska
New Hampshire
Oklahoma
Maine
Michigan
Minnesota
Missouri
Mississippi
South Carolina
Tennessee
Texas
Vermont
Wisconsin

ZONE 3 - 6%

Arizona
California
Colorado
Idaho
Montana
Nevada
New Mexico
North Dakota
Oregon
South Dakota
Utah
Washington
Wyoming

Quote Per Project

Alaska
Hawaii
Canada
(outside Ontario & Quebec)
Mexico

General Information

TEXTILE PARTNERS & APPROVALS

Textile Partners

To customize your furniture performance needs and design vision, Stylex offers a wide selection of in-graded leathers and textiles from Grades A through Y. We've partnered with leading manufacturers on the options, focusing on color, price, durability, and construction. To view our partners and explore our digital carded program with broadly approved textiles, visit [this page](#). We stand by these textiles: They're tried and tested, and will effortlessly fit into any design aesthetic.

Textile Approvals

To view Stylex Approved Textile documents to determine specific product approval status, refer to our Product Tested Textiles documents, available in the Resources section of each product on our website.

CAL 117 AND 133 COMPLIANCE

CAL 117-2013

All Stylex seating satisfies the requirements of CAL 117-2013 so long as one of our standard or in-graded textiles is applied. COM textiles cannot be so guaranteed. Please contact the supplier of COM's directly to determine the fire retardancy of any COM supplied to us.

CAL 133

Most Stylex seating can be ordered to meet the requirements of CAL 133. When ordering, simply specify "CAL 133 compliance required". The upcharge for this option is \$54 list per yard. Please refer to the COM yardage of each model to determine the number of yards required. We do frequently require full-scale burn tests in order to certify CAL 133 before an order will be accepted. Such burn tests may increase normal lead times and do carry additional charges. Please contact customer service for details.

CUSTOMER'S OWN MATERIAL/LEATHER

Customer's own material (COM) and customer's own leather (COL) will generally be upholstered at the price designated in each product's price list. Please be advised, however, that we specifically reserve the right to charge a higher price when we determine that special circumstances, such as unusual repeats or challenging materials, present themselves. All orders for custom coverings must be approved by Stylex before they will be accepted for production. To submit proposed textile for approval, please use the COM form [here](#).

Special Note:

We assume no responsibility for the durability or tailoring quality of any COM or COL. Directional covers in particular may not meet your satisfaction due to the design of certain products. Please be advised that COM and COL orders are not subject to return. If you have doubts about the ultimate appearance of certain coverings, please order a sample done with that specific COM or COL. In addition, while we inspect textiles for mill imperfections, some are difficult to recognize. We cannot be responsible for defects, color inaccuracies, dye lot variations, or other flaws.

Under no circumstances will we be responsible for COM shortages, flaws, or other such problems. Finally, it is not our responsibility to police the receipt of COM's in order to meet delivery deadlines, and we assume our customers are aware of any undue delay in the shipment of their COM textiles.

COM textile and COL leather should be sent prepaid to: Stylex

**Attn: COM/COL - [Your PO #]
740 Coopertown Road
Delanco, NJ 08075**

Clearly mark textile or leather with the dealer's name, purchase order number, and furniture model number of the item to be covered. Actual furniture orders should include the same information, as well as a description of the textile or leather, including pattern and color number, in order to provide a cross reference.

Yardage requirements shown in the price list are based on non-directional goods of 54" width. Textiles less than 54" wide or those requiring matching (stripes, prints, or large patterned designs) call for additional yardage. We will be happy to supply yardage requirements for large quantities where economies may be realized.

Add the following yardage for stripes, plaids, or patterns with repeats:

Textile Width	Plain Textile	2-14" Repeat	15-24" Repeat	25-27" Repeat	28-36" Repeat
54"	0%	10%	15%	20%	25%
50"	10%	20%	25%	30%	35%
48"	15%	25%	30%	35%	40%
45"	40%	50%	55%	60%	65%
36"	50%	60%	65%	70%	75%

COM/COL FORM

To avoid delay in processing COM orders we request that you submit a sample of your COM textile stapled to this form which can be downloaded [here](#). If a textile has a stripe or design, the size of the repeat should be indicated. Please indicate the textile supplier's name, textile number, and color. Also indicate the Stylex product on which the textile will be used.

The textile supplier must indicate on his shipping labels the dealer name and purchase order number as well as the Stylex model number.

Please Note:

No order may be entered into production or have a shipping date assigned until all related COM is received at the factory.



CENTER OF STRIPE OR DESIGN

TOP	TOP
-----	-----

1. Size of Repeat

2. Textile Supplier

3. Textile Number

4. Color

5. Stylex Product

Contents

<hr/>		<hr/>	
COLORS, MATERIALS, AND FINISHES	5	MEDIUM BACK: MESH BACK	9
STATEMENT OF LINE	6	MEDIUM BACK: STANDARD UPHOLSTERY BACK	15
DIMENSIONS	7	MEDIUM BACK: EURO UPHOLSTERY BACK	18
HOW TO ORDER	8	HIGH BACK	21
<hr/>		<hr/>	

CLICK THE TITLES ABOVE TO NAVIGATE THROUGH THE DOCUMENT
PRODUCT HEADERS ON SUBSEQUENT PAGES LINK BACK TO THIS PAGE

Sava

COLORS, MATERIALS, AND FINISHES

MESH COLORS

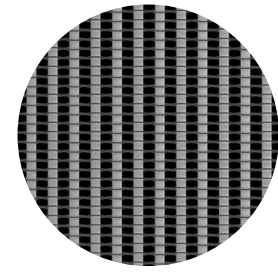

SILVER WHITE
(M3)

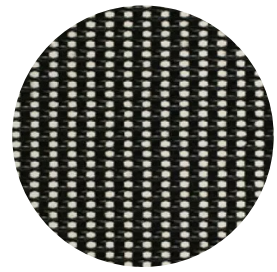

BLACK
(M1)

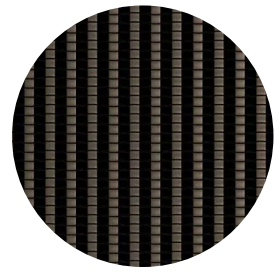

BRONZE
(M2)

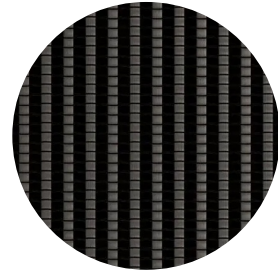

WARM GRAY
(M4)

POLISHED METAL

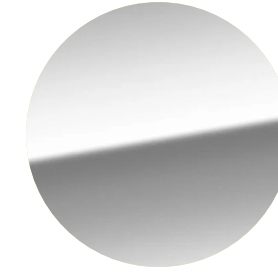



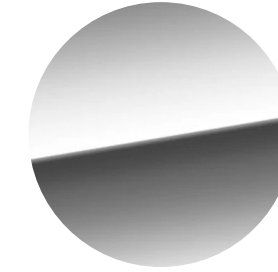



POLISHED
ALUMINUM
(AL)

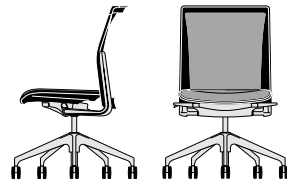
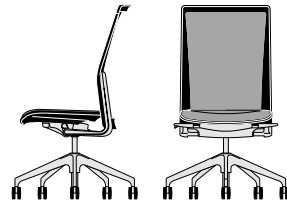
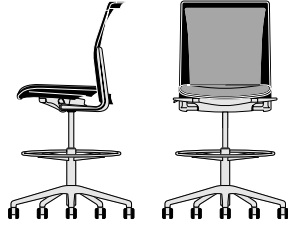
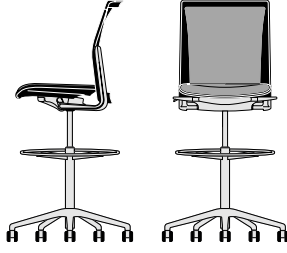
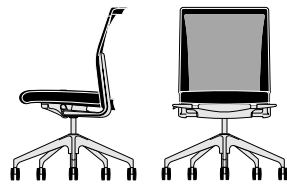
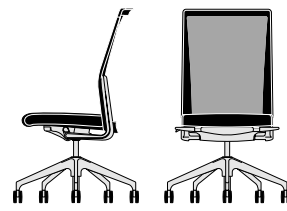
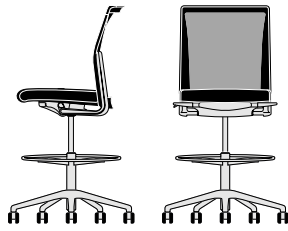
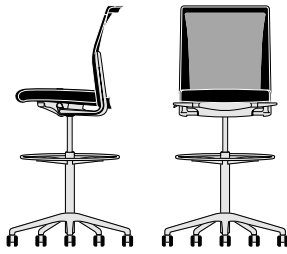

CHROME
(CH)

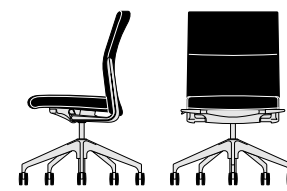
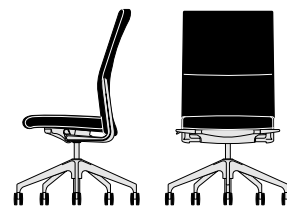
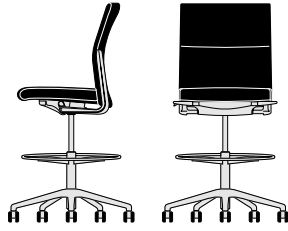
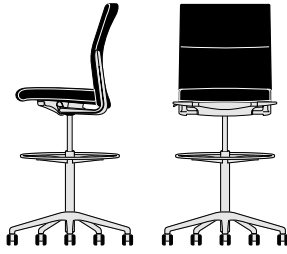
Sava

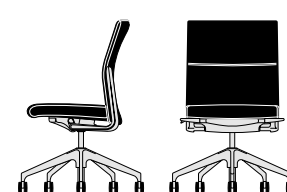
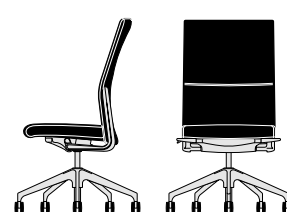
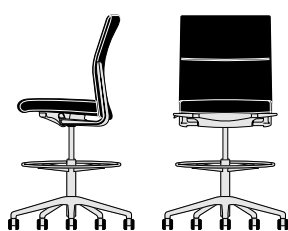
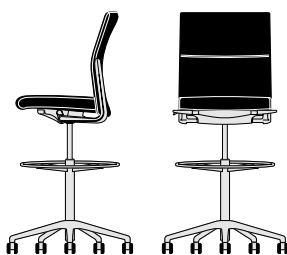
SPECIFICATION GUIDE: STATEMENT OF LINE

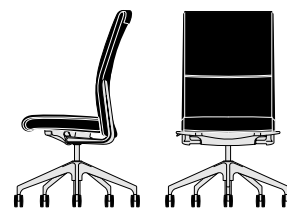
OVERVIEW	MEDIUM BACK CHAIR	HIGH BACK CHAIR	COUNTER STOOL	BAR STOOL
Mesh Back, Mesh Seat				
Mesh Back, Upholstered Seat				
Standard Upholstery Back, Upholstered Seat 				
Euro Upholstery Back, Euro Upholstery Seat 				
Thin Pad Back, Thin Pad Seat 				

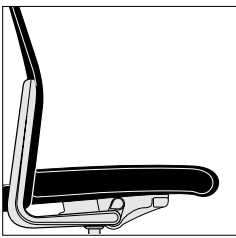
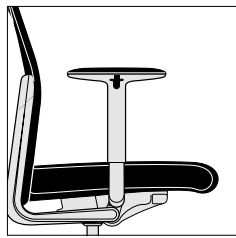
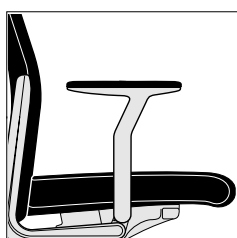
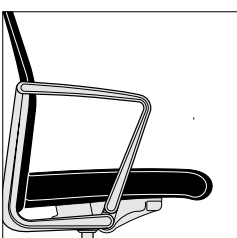
OPTION OVERVIEW	Armless	Height Adjustable Arm	Fixed Height T-Arm	Fixed-Height D-Arm
Arm Choices				

Options	Upholstered Arm Caps Black Plastic Arm Caps for D-Arm	Contrasting Thread for Upholstered Seats/Backs	Lumbar Support for Mesh Backs	Casters and Glide Options
----------------	--	--	-------------------------------	---------------------------

GENERAL INFORMATION

Design

Sava Cvek

Controls

On upholstered seats, multi-task control offers four adjustments – seat height, seat depth, tilt tension, and tilt lock. Conference models have two adjustments: seat height and tilt lock. Single Paddle mechanisms offer the same superior comfort as the multi-task control, but, other than seat height, they are not user-adjustable. All Sava chairs offer seat height adjustment lock-out. This function is user-friendly and may be easily adjusted in the field.

Back Supports

Back supports, attached to the control by metal fasteners, are aluminum.

Arms

Adjustable arms are primarily cast aluminum. Caps are self-skinned black polyurethane foam that may be optionally upholstered. Fixed T-arms are cast aluminum. Caps are self-skinned black polyurethane foam that may be optionally upholstered. Fixed D-arms are cast aluminum and may be specified with plastic caps. D-arms may be upholstered in leather, vinyl, or polyurethane.

Bases

Bases are cast aluminum.

Use

Designed for indoor use only.

Performance Standards

Manufactured to comply with:
ANSI/BIFMA X5.1 General-Purpose Office Chairs - Tests

Certifications

GREENGUARD Gold
LEVEL® 1, BIFMA's sustainability certification program for furniture

Sava

SPECIFICATION GUIDE: DIMENSIONS

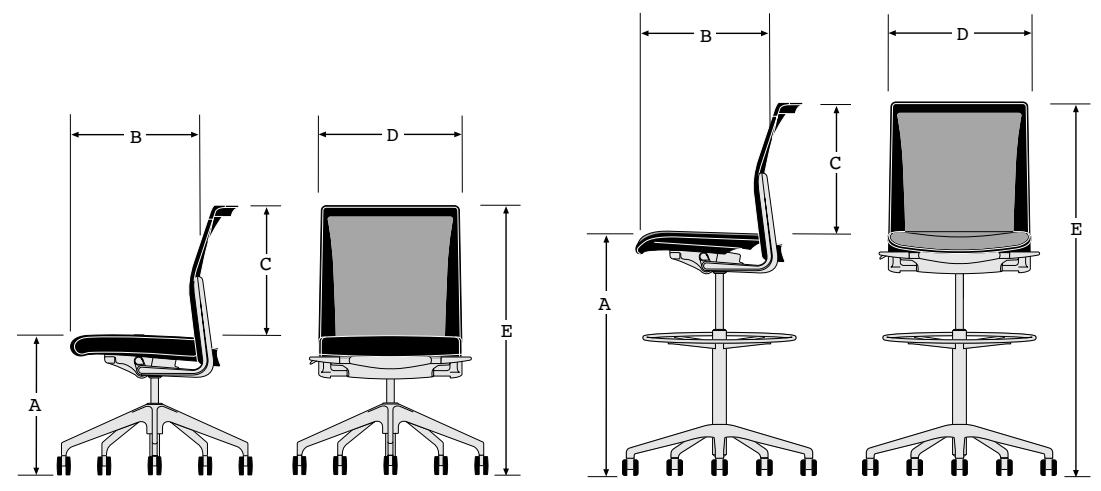
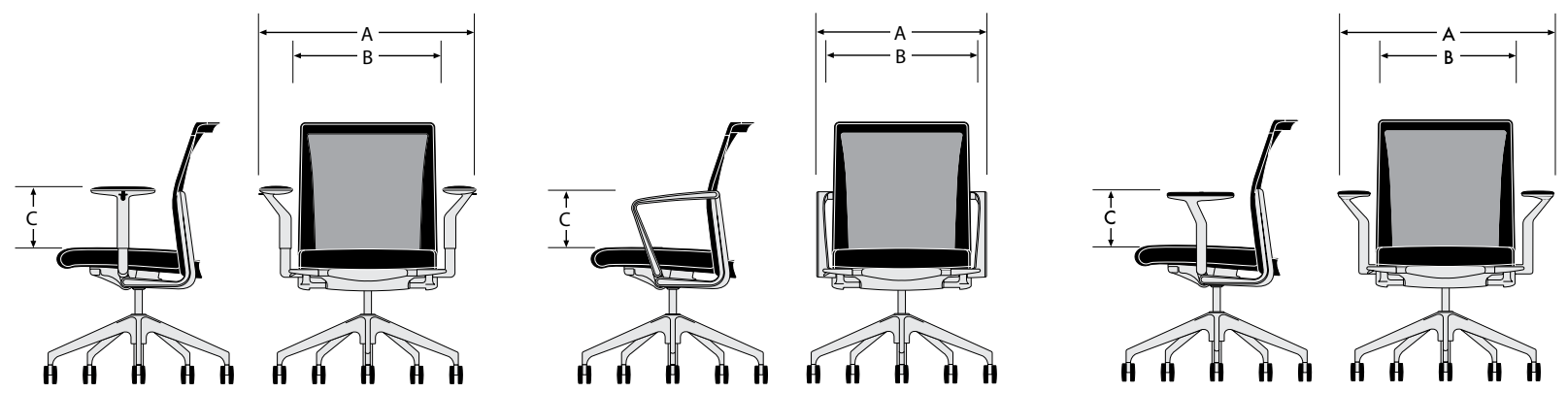
OVERVIEW	CHAIR		STOOL	
<p>Dimensions</p> <p>A. Seat Height*</p> <p>B. Seat Depth</p> <p>C. Back Height</p> <p>D. Seat Width & Overall Width (Armless)</p> <p>E. Maximum Overall Height*</p> <p>* Measurements given are for most controls, upholstered seats, and mesh backs. Specific models may vary slightly.</p> 	<p>Medium Back</p> <p>A. 16-21</p> <p>B. 16.5-18.5</p> <p>C. 17.5</p> <p>D. 19</p> <p>E. 33-38</p>	<p>High Back</p> <p>A. 16-21</p> <p>B. 16.5-18.5</p> <p>C. 22.5</p> <p>D. 19</p> <p>E. 37.5-42.5</p>	<p>Counter Stool</p> <p>A. 21-28</p> <p>B. 16.5-18.5</p> <p>C. 17.5</p> <p>D. 19</p> <p>E. 38.5-45.5</p>	<p>Bar Stool</p> <p>A. 23.25-33.25</p> <p>B. 16.5-18.5</p> <p>C. 17.5</p> <p>D. 19</p> <p>E. 40.75-50.75</p>
<p>Arm Choice</p> <p>A. Overall Width</p> <p>B. Distance Between Arms</p> <p>C. Arm Height</p> 	<p>Height Adjustable Arm</p> <p>A. 27.5</p> <p>B. 20.5</p> <p>C. 6-9</p> <p>Arms rotate inward 45°</p>	<p>Fixed Height D-Arm</p> <p>A. 23.5</p> <p>B. 21</p> <p>C. 7.75</p>	<p>Fixed Height T-Arm</p> <p>A. 27.5</p> <p>B. 20.5</p> <p>C. 7.5</p>	

Sava

SPECIFICATION GUIDE: HOW TO ORDER

MODEL CODE BREAKDOWN

Sample Model Code: **SV16105M305UCLUBSALCOM**

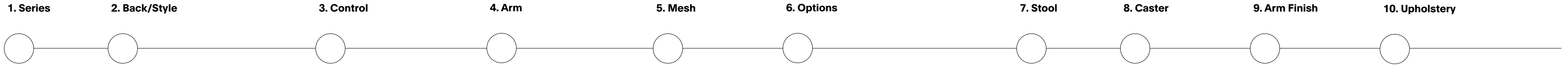

SV **16** **1** **05** **M3** **05UC LU** **~** **BS** **AL** **COM**



1. Series	2. Back/Style	3. Control	4. Arm	5. Mesh	6. Options	7. Stool	8. Caster	9. Arm Finish	10. Upholstery
Series SV SAVA	Medium Back 16 MESH BACK MESH SEAT 26 MESH BACK UPHOLSTERED SEAT 46 STANDARD UPHOLSTERED BACK UPHOLSTERED SEAT 56 EURO UPHOLSTERY BACK EURO UPHOLSTERY SEAT High Back 18 MESH BACK MESH SEAT 28 MESH BACK UPHOLSTERED SEAT 48 STANDARD UPHOLSTERED BACK UPHOLSTERED SEAT 58 EURO UPHOLSTERY BACK EURO UPHOLSTERY SEAT 78 THIN PAD BACK THIN PAD SEAT	Control 1 SINGLE PADDLE 2 CONFERENCE 4 MULTI-TASK (UPHOLSTERED SEAT)	Arm 00 ARMLESS 01 HEIGHT ADJUSTABLE ARM 05 FIXED HEIGHT T-ARM 07 FIXED HEIGHT D-ARM	Mesh M1 BLACK M2 BRONZE M3 SILVER WHITE M4 WARM GREY	Options 01UC UPHOLSTERED ARM CAPS FOR HEIGHT ADJUSTABLE ARMS 05UC UPHOLSTERED ARM CAPS FOR FIXED HEIGHT T-ARMS 07UC UPHOLSTERED ARM CAPS FOR FIXED HEIGHT D-ARMS AC BLACK PLASTIC ARM CAPS FOR FIXED HEIGHT D-ARMS LU ADJUSTABLE LUMBAR SUPPORT CT CONTRASTING THREAD <small>Adjustable lumbar support for mesh back chairs only. Upholstered arm caps must be leather, vinyl, or polyurethane. Height adjustment lock-out comes standard on all Sava chairs.</small>	Stool M COUNTER H BAR	Caster BC BLACK HARD WHEEL BS BLACK SOFT WHEEL CC CHROME TRIM CS CHROME TRIM SOFT WHEEL GA GLIDES W/ ABS PADS GF GLIDES W/ FELT PADS	Arm Finish AL POLISHED ALUMINUM BM BLACK MATTE CH CHROME <small>Black Matte finish is only available on the Single Paddle control. Black Matte finish on arms is only available on Fixed Height T-Arm (05) or D-Arm (07).</small> <small>Chrome finish is only available on Fixed Height D-Arms (07)</small>	Textile Grades COM CUSTOMER'S OWN MATERIAL A GRADE A B GRADE B C GRADE C D GRADE D E GRADE E F GRADE F G GRADE G H GRADE H I GRADE I J GRADE J K GRADE K L GRADE L M GRADE M Leather Grades COL CUSTOMER'S OWN LEATHER W GRADE W X GRADE X Y GRADE Y E1 GRADE E1 E2 GRADE E2

Sava

MEDIUM BACK: MESH BACK, MESH SEAT, CONFERENCE MECHANISM

TITLE	STYLE	CTRL	ARM	HEIGHT	DIMENSIONS	YDG	SQFT	Textile Upholstery Grades										Leather Upholstery Grades								
								COM	COL	COM	COL	A	B	C	D	E	F	G	H	I	J	K	L	M	W	X
 <p>Medium Back, Mesh Back, Mesh Seat, Conference Mechanism</p>	Armless	SV16	2	00		19W x 26.5D x 33-38H	0	0	1847																	
		SV16	2	00	M	19W x 26.5D x 38.5-45.5H	0	0	2000																	
		SV16	2	00	H	19W x 26.5D x 40.75-50.75H	0	0	2000																	
	Adjustable Arm	SV16	2	01		27.5W x 26.5D x 33-38H	0	0	2294																	
		SV16	2	01	M	27.5W x 26.5D x 38.5-45.5H	0	0	2448																	
		SV16	2	01	H	27.5W x 26.5D x 40.75-50.75H	0	0	2448																	
	Fixed T-Arm	SV16	2	05		27.5W x 26.5D x 33-38H	0	0	2080																	
		SV16	2	05	M	27.5W x 26.5D x 38.5-45.5H	0	0	2233																	
		SV16	2	05	H	27.5W x 26.5D x 40.75-50.75H	0	0	2233																	
	Fixed D-Arm	SV16	2	07	0	23.5W x 26.5D x 33-38H	0	0	2010																	
		SV16	2	07	M	23.5W x 26.5D x 38.5-45.5H	0	0	2163																	
		SV16	2	07	H	23.5W x 26.5D x 40.75-50.75H	0	0	2163																	

To Order Select Below

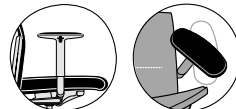
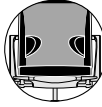

<p>1. Series/Back/Style</p> <p>SV16</p> <p>Sava Chair Medium Back, Mesh Back, Mesh Seat</p>	<p>2. Control</p> <p>2 CONFERENCE MECHANISM</p> <p>Adjustments Preset Recline Tension Pneumatic Seat Height Tilt Lock</p>	<p>3. Arm</p> <p>00 ARMLESS 01 HEIGHT ADJUSTABLE ARMS 05 FIXED HEIGHT T-ARM 07 FIXED HEIGHT D-ARM</p> <p> Armless  T-Arm  D-Arm</p> <p> Height Adjustable Arms</p> <p>Height adjustable arms come standard with 45° inward rotation and urethane caps.</p>	<p>4. Mesh</p> <p>M1 BLACK M2 BRONZE M3 SILVER WHITE M4 WARM GRAY</p>	<p>5. Options</p> <p>01UC UPHOLSTERED ARM CAP FOR HEIGHT ADJUSTABLE ARM +72</p> <p>05UC UPHOLSTERED ARM CAP FOR T-ARM +72</p> <p>07UC UPHOLSTERED ARM CAP FOR D-ARM +173</p> <p>AC BLACK PLASTIC ARM CAP FOR D-ARM +32</p> <p>LU ADJUSTABLE LUMBAR PADS +58</p> <p> Adjustable lumbar pads for Mesh Backs</p> <p>Upholstered arm caps must be leather, vinyl, or polyurethane. Height adjustment lock-out comes standard on all Sava chairs.</p>	<p>6. Stool</p> <p>M COUNTER STOOL H BAR STOOL</p> <p>Stool Heights available with Medium Back only.</p>	<p>7. Caster</p> <p>BC BLACK HARD WHEEL BS BLACK SOFT WHEEL +42 CC CHROME TRIM +98 CS CHROME TRIM SOFT WHEEL +123 GA GLIDES W/ABS PADS +98 GF GLIDES W/FELT PADS +98</p>	<p>8. Arm Finish</p> <p>AL POLISHED ALUMINUM CH CHROME +473</p> <p>Chrome finish is only available on Fixed Height D-Arms (07)</p>	<p>9. Upholstery</p> <p>See general information section for details on textile program and COM/ COL information.</p>
---	---	---	--	---	---	--	--	---

Sava

MEDIUM BACK: MESH BACK, MESH SEAT, SINGLE PADDLE MECHANISM

TITLE	STYLE	CTRL	ARM	HEIGHT	DIMENSIONS	YDG	SQFT	Textile Upholstery Grades												Leather Upholstery Grades						
								COM	COL	COM	COL	A	B	C	D	E	F	G	H	I	J	K	L	M	W	X
 Medium Back, Mesh Back, Mesh Seat, Single Paddle Mechanism	Armless	SV16	1	00		19W x 26.5D x 33-38H	0	0	1570																	
		SV16	1	00	M	19W x 26.5D x 38.5-45.5H	0	0	1723																	
		SV16	1	00	H	19W x 26.5D x 40.75-50.75H	0	0	1723																	
	Adjustable Arm	SV16	1	01		27.5W x 26.5D x 33-38H	0	0	2016																	
		SV16	1	01	M	27.5W x 26.5D x 38.5-45.5H	0	0	2169																	
		SV16	1	01	H	27.5W x 26.5D x 40.75-50.75H	0	0	2169																	
	Fixed T-Arm	SV16	1	05		27.5W x 26.5D x 33-38H	0	0	1801																	
		SV16	1	05	M	27.5W x 26.5D x 38.5-45.5H	0	0	1954																	
		SV16	1	05	H	27.5W x 26.5D x 40.75-50.75H	0	0	1954																	
	Fixed D-Arm	SV16	1	07		23.5W x 26.5D x 33-38H	0	0	1730																	
		SV16	1	07	M	23.5W x 26.5D x 38.5-45.5H	0	0	1884																	
		SV16	1	07	H	23.5W x 26.5D x 40.75-50.75H	0	0	1884																	

To Order Select Below

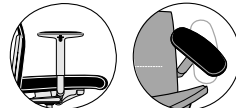
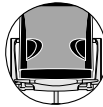



<p>1. Series/Back/Style</p> <p>SV16</p> <p>Sava Chair Medium Back, Mesh Back, Mesh Seat</p>	<p>2. Control</p> <p>1 SINGLE PADDLE MECHANISM</p> <p>Adjustments Preset Recline Tension Pneumatic Seat Height</p>	<p>3. Arm</p> <p>00 ARMLESS 01 HEIGHT ADJUSTABLE ARMS 05 FIXED HEIGHT T-ARM 07 FIXED HEIGHT D-ARM</p> <p> Armless  T-Arm  D-Arm</p> <p> Height Adjustable Arms</p> <p>Height adjustable arms come standard with 45° inward rotation and urethane caps.</p>	<p>4. Mesh</p> <p>M1 BLACK M2 BRONZE M3 SILVER WHITE M4 WARM GRAY</p>	<p>5. Options</p> <p>01UC UPHOLSTERED ARM CAP FOR HEIGHT ADJUSTABLE ARM +72</p> <p>05UC UPHOLSTERED ARM CAP FOR T-ARM +72</p> <p>07UC UPHOLSTERED ARM CAP FOR D-ARM +173</p> <p>AC BLACK PLASTIC ARM CAP FOR D-ARM +32</p> <p>LU ADJUSTABLE LUMBAR PADS +58</p> <p> Adjustable lumbar pads for Mesh Backs</p> <p>Upholstered arm caps must be leather, vinyl, or polyurethane. Height adjustment lock-out comes standard on all Sava chairs.</p>	<p>6. Stool</p> <p>M COUNTER STOOL H BAR STOOL</p> <p>Stool Heights available with Medium Back only.</p>	<p>7. Caster</p> <p>BC BLACK HARD WHEEL BS BLACK SOFT WHEEL +42 CC CHROME TRIM +98 CS CHROME TRIM SOFT WHEEL +123 GA GLIDES W/ABS PADS +98 GF GLIDES W/FELT PADS +98</p>	<p>8. Arm Finish</p> <p>AL POLISHED ALUMINUM CH CHROME +473 BM BLACK MATTE</p> <p>Chrome finish is only available on Fixed Height D-Arms (07).</p> <p>Black Matte finish is only available on the Single Paddle control. Black Matte finish on arms is only available on Fixed Height T-Arm (05) or D-Arm (07).</p>	<p>9. Upholstery</p> <p>See general information section for details on textile program and COM/ COL information.</p>
---	--	---	--	---	---	--	---	---

Sava

MEDIUM BACK: MESH BACK, UPHOLSTERED SEAT, CONFERENCE MECHANISM

TITLE	STYLE	CTRL	ARM	HEIGHT	DIMENSIONS	YDG	SQFT	Textile Upholstery Grades										Leather Upholstery Grades								
								COM	COL	COM	COL	A	B	C	D	E	F	G	H	I	J	K	L	M	W	X
 <p>Medium Back, Mesh Back, Upholstered Seat, Conference Mechanism</p>	Armless	SV26	2	00		19W x 26.5D x 33-38H	0.8	10	1662	1700	1739	1775	1812	1853	1891	1938	1985	2038	2116	2181	2244	1929	1967	2184	2271	2418
					M				1815	1853	1892	1928	1966	2007	2044	2092	2138	2191	2270	2335	2398	2082	2120	2337	2424	2571
					H				1815	1853	1892	1928	1966	2007	2044	2092	2138	2191	2270	2335	2398	2082	2120	2337	2424	2571
	Adjustable Arm	SV26	2	01		27.5W x 26.5D x 33-38H	0.8	10	2111	2146	2184	2223	2259	2298	2336	2385	2430	2485	2562	2627	2689	2375	2414	2659	2745	2890
					M				2264	2300	2337	2376	2412	2452	2490	2538	2583	2639	2716	2780	2843	2528	2567	2812	2898	3043
					H				2264	2300	2337	2376	2412	2452	2490	2538	2583	2639	2716	2780	2843	2528	2567	2812	2898	3043
	Fixed T-Arm	SV26	2	05		27.5W x 26.5D x 33-38H	0.8	10	1895	1933	1970	2007	2044	2084	2123	2170	2217	2270	2348	2413	2476	2161	2198	2430	2519	2662
					M				2049	2086	2123	2160	2198	2238	2276	2324	2370	2423	2501	2566	2629	2314	2351	2583	2672	2815
					H				2049	2086	2123	2160	2198	2238	2276	2324	2370	2423	2501	2566	2629	2314	2351	2583	2672	2815
	Fixed D-Arm	SV26	2	07		23.5W x 26.5D x 33-38H	0.8	10	1825	1862	1901	1938	1975	2016	2054	2100	2148	2202	2280	2345	2408	2094	2130	2358	2443	2590
					M				1978	2015	2054	2092	2128	2169	2207	2253	2302	2355	2433	2499	2562	2247	2284	2512	2597	2744
					H				1978	2015	2054	2092	2128	2169	2207	2253	2302	2355	2433	2499	2562	2247	2284	2512	2597	2744

To Order Select Below

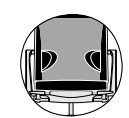





<p>1. Series/Back/Style</p> <p>SV26</p> <p>Sava Chair Medium Back, Mesh Back, Upholstered Seat</p>	<p>2. Control</p> <p>2 CONFERENCE MECHANISM</p> <p>Adjustments Preset Recline Tension Pneumatic Seat Height Tilt Lock</p>	<p>3. Arm</p> <p>00 ARMLESS 01 HEIGHT ADJUSTABLE ARMS 05 FIXED HEIGHT T-ARM 07 FIXED HEIGHT D-ARM</p> <p> Armless  T-Arm  D-Arm</p> <p>  Height Adjustable Arms</p> <p>Height adjustable arms come standard with 45° inward rotation and urethane caps.</p>	<p>4. Mesh</p> <p>M1 BLACK M2 BRONZE M3 SILVER WHITE M4 WARM GRAY</p>	<p>5. Options</p> <p>01UC UPHOLSTERED ARM CAP FOR HEIGHT ADJUSTABLE ARM +72</p> <p>05UC UPHOLSTERED ARM CAP FOR T-ARM +72</p> <p>07UC UPHOLSTERED ARM CAP FOR D-ARM +173</p> <p>AC BLACK PLASTIC ARM CAP FOR D-ARM +32</p> <p>LU ADJUSTABLE LUMBAR PADS +58</p> <p>CT CONTRASTING THREAD</p> <p> Adjustable lumbar pads for Mesh Backs</p> <p>Upholstered arm caps must be leather, vinyl, or polyurethane. Height adjustment lock-out comes standard on all Sava chairs.</p>	<p>6. Stool</p> <p>M COUNTER STOOL H BAR STOOL</p> <p>Stool Heights available with Medium Back only.</p>	<p>7. Caster</p> <p>BC BLACK HARD WHEEL BS BLACK SOFT WHEEL +42 CC CHROME TRIM +98 CS CHROME TRIM SOFT WHEEL +123 GA GLIDES W/ABS PADS +98 GF GLIDES W/FELT PADS +98</p>	<p>8. Arm Finish</p> <p>AL POLISHED ALUMINUM CH CHROME +473</p> <p>Chrome finish is only available on Fixed Height D-Arms (07)</p>	<p>9. Upholstery</p> <p>See general information section for details on textile program and COM/ COL information.</p>
--	---	---	--	--	---	--	--	---

Sava

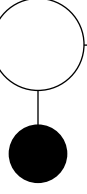
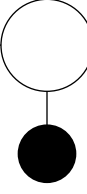
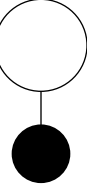
MEDIUM BACK: MESH BACK, UPHOLSTERED SEAT, MULTI-TASK MECHANISM

TITLE	STYLE	CTRL	ARM	HEIGHT	DIMENSIONS	YDG	SQFT	Textile Upholstery Grades				Leather Upholstery Grades														
								COM	COL	COM	COL	A	B	C	D	E	F	G	H	I	J	K	L	M	W	X
 Medium Back, Mesh Back, Upholstered Seat, Multi-Task Mechanism	Armless	SV26	4	00		19W x 26.5D x 33-38H	0.8	10	1782	1819	1856	1894	1931	1971	2010	2056	2103	2158	2235	2300	2363	2048	2085	2311	2397	2542
		SV26	4	00	M	19W x 26.5D x 38.5-45.5H	0.8	10	1935	1972	2010	2048	2084	2124	2163	2209	2256	2311	2388	2453	2516	2201	2239	2464	2550	2695
		SV26	4	00	H	19W x 26.5D x 40.75-50.75H	0.8	10	1935	1972	2010	2048	2084	2124	2163	2209	2256	2311	2388	2453	2516	2201	2239	2464	2550	2695
	Adjustable Arm	SV26	4	01		27.5W x 26.5D x 33-38H	0.8	10	2229	2266	2303	2340	2377	2419	2456	2503	2552	2604	2682	2747	2810	2495	2533	2784	2872	3017
		SV26	4	01	M	27.5W x 26.5D x 38.5-45.5H	0.8	10	2382	2419	2456	2494	2531	2573	2609	2657	2705	2757	2836	2901	2964	2648	2686	2937	3025	3170
		SV26	4	01	H	27.5W x 26.5D x 40.75-50.75H	0.8	10	2382	2419	2456	2494	2531	2573	2609	2657	2705	2757	2836	2901	2964	2648	2686	2937	3025	3170
	Fixed T-Arm	SV26	4	05		27.5W x 26.5D x 33-38H	0.8	10	2013	2051	2087	2127	2163	2203	2241	2290	2335	2391	2468	2534	2597	2281	2318	2558	2642	2790
		SV26	4	05	M	27.5W x 26.5D x 38.5-45.5H	0.8	10	2166	2204	2241	2281	2316	2356	2394	2443	2489	2544	2622	2687	2750	2434	2472	2711	2795	2943
		SV26	4	05	H	27.5W x 26.5D x 40.75-50.75H	0.8	10	2166	2204	2241	2281	2316	2356	2394	2443	2489	2544	2622	2687	2750	2434	2472	2711	2795	2943
	Fixed D-Arm	SV26	4	07		23.5W x 26.5D x 33-38H	0.8	10	1946	1983	2019	2056	2095	2135	2172	2223	2268	2322	2400	2465	2529	2211	2249	2484	2569	2717
		SV26	4	07	M	23.5W x 26.5D x 38.5-45.5H	0.8	10	2099	2137	2172	2209	2248	2288	2326	2376	2421	2475	2553	2618	2682	2365	2402	2638	2723	2871
		SV26	4	07	H	23.5W x 26.5D x 40.75-50.75H	0.8	10	2099	2137	2172	2209	2248	2288	2326	2376	2421	2475	2553	2618	2682	2365	2402	2638	2723	2871

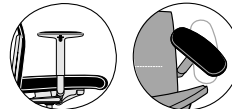
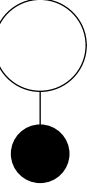
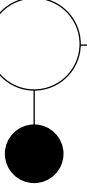
To Order Select Below

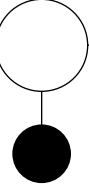
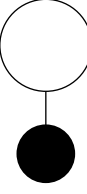
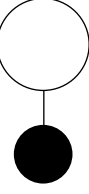
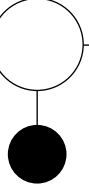

<p>1. Series/Back/Style</p>  <p>SV26</p> <p>Sava Chair Medium Back, Mesh Back, Upholstered Seat</p>	<p>2. Control</p>  <p>Control</p> <p>4 MULTI-TASK MECHANISM</p> <p>Adjustments 4-Position Tilt Tension Pneumatic Seat Height Tilt Lock Seat Depth</p>	<p>3. Arm</p>  <p>Arm</p> <p>00 ARMLESS 01 HEIGHT ADJUSTABLE ARMS 05 FIXED HEIGHT T-ARM 07 FIXED HEIGHT D-ARM</p> <p> Armless  T-Arm  D-Arm</p> <p> Height Adjustable Arms</p> <p>Height adjustable arms come standard with 45° inward rotation and urethane caps.</p>	<p>4. Mesh</p>  <p>Mesh</p> <p>M1 BLACK M2 BRONZE M3 SILVER WHITE M4 WARM GRAY</p>	<p>5. Options</p>  <p>Options</p> <p>01UC UPHOLSTERED ARM CAP FOR HEIGHT ADJUSTABLE ARM +72</p> <p>05UC UPHOLSTERED ARM CAP FOR T-ARM +72</p> <p>07UC UPHOLSTERED ARM CAP FOR D-ARM +173</p> <p>AC BLACK PLASTIC ARM CAP FOR D-ARM +32</p> <p>LU ADJUSTABLE LUMBAR PADS +58</p> <p>CT CONTRASTING THREAD</p> <p> Adjustable lumbar pads for Mesh Backs</p> <p>Upholstered arm caps must be leather, vinyl, or polyurethane. Height adjustment lock-out comes standard on all Sava chairs.</p>	<p>6. Stool</p>  <p>Stool</p> <p>M COUNTER STOOL H BAR STOOL</p> <p>Stool Heights available with Medium Back only.</p>	<p>7. Caster</p>  <p>Caster</p> <p>BC BLACK HARD WHEEL BS BLACK SOFT WHEEL +42 CC CHROME TRIM +98 CS CHROME TRIM SOFT WHEEL +123 GA GLIDES W/ABS PADS +98 GF GLIDES W/FELT PADS +98</p>	<p>8. Arm Finish</p>  <p>Arm Finish</p> <p>AL POLISHED ALUMINUM CH CHROME +473</p> <p>Chrome finish is only available on Fixed Height D-Arms (07)</p>	<p>9. Upholstery</p>  <p>See general information section for details on textile program and COM/ COL information.</p>
---	---	---	---	--	---	---	---	--

Sava

MEDIUM BACK: MESH BACK, UPHOLSTERED SEAT, SINGLE PADDLE MECHANISM

TITLE	STYLE	CTRL	ARM	HEIGHT	DIMENSIONS	YDG	SQFT	Textile Upholstery Grades										Leather Upholstery Grades								
								COM	COL	COM	COL	A	B	C	D	E	F	G	H	I	J	K	L	M	W	X
 Medium Back, Mesh Back, Upholstered Seat, Single Paddle Mechanism	Armless	SV26	1	00		19W x 26.5D x 33-38H	0.8	10	1386	1423	1460	1496	1533	1575	1614	1660	1707	1760	1838	1903	1966	1651	1687	1890	1979	2122
		SV26	1	00	M	19W x 26.5D x 38.5-45.5H	0.8	10	1539	1576	1613	1650	1686	1728	1767	1813	1861	1913	1991	2056	2119	1804	1841	2043	2133	2275
		SV26	1	00	H	19W x 26.5D x 40.75-50.75H	0.8	10	1539	1576	1613	1650	1686	1728	1767	1813	1861	1913	1991	2056	2119	1804	1841	2043	2133	2275
	Adjustable Arm	SV26	1	01		27.5W x 26.5D x 33-38H	0.8	10	1831	1869	1908	1945	1981	2021	2058	2106	2153	2207	2284	2349	2412	2098	2136	2365	2452	2595
		SV26	1	01	M	27.5W x 26.5D x 38.5-45.5H	0.8	10	1985	2022	2061	2098	2135	2175	2211	2260	2306	2360	2437	2502	2565	2251	2289	2518	2605	2748
		SV26	1	01	H	27.5W x 26.5D x 40.75-50.75H	0.8	10	1985	2022	2061	2098	2135	2175	2211	2260	2306	2360	2437	2502	2565	2251	2289	2518	2605	2748
	Fixed T-Arm	SV26	1	05		27.5W x 26.5D x 33-38H	0.8	10	1618	1656	1692	1728	1766	1808	1846	1893	1938	1993	2070	2135	2198	1884	1919	2136	2224	2368
		SV26	1	05	M	27.5W x 26.5D x 38.5-45.5H	0.8	10	1771	1809	1845	1882	1919	1961	1999	2046	2092	2146	2224	2289	2352	2037	2073	2289	2377	2521
		SV26	1	05	H	27.5W x 26.5D x 40.75-50.75H	0.8	10	1771	1809	1845	1882	1919	1961	1999	2046	2092	2146	2224	2289	2352	2037	2073	2289	2377	2521
Fixed D-Arm	SV26	1	07		23.5W x 26.5D x 33-38H	0.8	10	1548	1586	1622	1660	1697	1739	1776	1823	1870	1924	2002	2067	2130	1815	1853	2065	2150	2295	
	SV26	1	07	M	23.5W x 26.5D x 38.5-45.5H	0.8	10	1701	1739	1776	1813	1850	1892	1929	1976	2023	2077	2155	2220	2283	1969	2007	2219	2304	2449	
	SV26	1	07	H	23.5W x 26.5D x 40.75-50.75H	0.8	10	1701	1739	1776	1813	1850	1892	1929	1976	2023	2077	2155	2220	2283	1969	2007	2219	2304	2449	

To Order Select Below

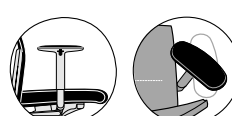
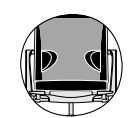

<p>1. Series/Back/Style</p> <p>SV26</p> <p>Sava Chair Medium Back, Mesh Back, Upholstered Seat</p>	<p>2. Control</p> <p>1 SINGLE PADDLE MECHANISM</p> <p>Adjustments Preset Recline Tension Pneumatic Seat Height</p>	<p>3. Arm</p> <p>00 ARMLESS 01 HEIGHT ADJUSTABLE ARMS 05 FIXED HEIGHT T-ARM 07 FIXED HEIGHT D-ARM</p> <p> Armless  T-Arm  D-Arm</p> <p> Height Adjustable Arms</p> <p>Height adjustable arms come standard with 45° inward rotation and urethane caps.</p>	<p>4. Mesh</p> <p>M1 BLACK M2 BRONZE M3 SILVER WHITE M4 WARM GRAY</p>	<p>5. Options</p> <p>01UC UPHOLSTERED ARM CAP FOR HEIGHT ADJUSTABLE ARM +72</p> <p>05UC UPHOLSTERED ARM CAP FOR T-ARM +72</p> <p>07UC UPHOLSTERED ARM CAP FOR D-ARM +173</p> <p>AC BLACK PLASTIC ARM CAP FOR D-ARM +32</p> <p>LU ADJUSTABLE LUMBAR PADS +58</p> <p>CT CONTRASTING THREAD</p> <p> Adjustable lumbar pads for Mesh Backs</p> <p>Upholstered arm caps must be leather, vinyl, or polyurethane. Height adjustment lock-out comes standard on all Sava chairs.</p>	<p>6. Stool</p> <p>M COUNTER STOOL H BAR STOOL</p> <p>Stool Heights available with Medium Back only.</p>	<p>7. Caster</p> <p>BC BLACK HARD WHEEL BS BLACK SOFT WHEEL +42 CC CHROME TRIM +98 CS CHROME TRIM SOFT WHEEL +123 GA GLIDES W/ABS PADS +98 GF GLIDES W/FELT PADS +98</p>	<p>8. Arm Finish</p> <p>AL POLISHED ALUMINUM CH CHROME +473 BM BLACK MATTE</p> <p>Chrome finish is only available on Fixed Height D-Arms (07).</p> <p>Black Matte finish is only available on the Single Paddle control. Black Matte finish on arms is only available on Fixed Height T-Arm (05) or D-Arm (07).</p>	<p>9. Upholstery</p> <p>See general information section for details on textile program and COM/ COL information.</p>
--	--	---	--	--	---	--	---	---

Sava

MEDIUM BACK: STANDARD UPHOLSTERY BACK, UPHOLSTERED SEAT, CONFERENCE MECHANISM

TITLE	STYLE	CTRL	ARM	HEIGHT	DIMENSIONS	YDG	SQFT	Textile Upholstery Grades										Leather Upholstery Grades							
								COM	COL	COM	COL	A	B	C	D	E	F	G	H	I	J	K	L	M	W
 <p>Medium Back, Standard Upholstery Back, Upholstered Seat, Conference Mechanism</p>	Armless	2	00		19W x 26.5D x 33-38H	1.5	24	1870	1943	2013	2083	2156	2231	2307	2397	2490	2586	2738	2862	2983	2567	2657	3068	3360	3631
				M	19W x 26.5D x 38.5-45.5H	1.5	24	2023	2096	2166	2237	2309	2385	2460	2550	2643	2739	2891	3015	3136	2721	2810	3221	3513	3784
				H	19W x 26.5D x 40.75-50.75H	1.5	24	2023	2096	2166	2237	2309	2385	2460	2550	2643	2739	2891	3015	3136	2721	2810	3221	3513	3784
	Adjustable Arm	2	01		27.5W x 26.5D x 33-38H	1.5	24	2324	2397	2469	2539	2611	2687	2764	2852	2943	3043	3194	3319	3439	3022	3113	3549	3842	4113
				M	27.5W x 26.5D x 38.5-45.5H	1.5	24	2477	2550	2622	2692	2765	2840	2917	3005	3096	3196	3347	3472	3592	3175	3267	3702	3995	4266
				H	27.5W x 26.5D x 40.75-50.75H	1.5	24	2477	2550	2622	2692	2765	2840	2917	3005	3096	3196	3347	3472	3592	3175	3267	3702	3995	4266
	Fixed T-Arm	2	05		27.5W x 26.5D x 33-38H	1.5	24	2106	2179	2249	2321	2393	2469	2542	2633	2724	2822	2973	3097	3218	2804	2893	3318	3610	3882
				M	27.5W x 26.5D x 38.5-45.5H	1.5	24	2260	2332	2402	2474	2546	2622	2695	2787	2877	2976	3127	3251	3371	2957	3046	3471	3763	4035
				H	27.5W x 26.5D x 40.75-50.75H	1.5	24	2260	2332	2402	2474	2546	2622	2695	2787	2877	2976	3127	3251	3371	2957	3046	3471	3763	4035
	Fixed D-Arm	2	07		23.5W x 26.5D x 33-38H	1.5	24	2037	2109	2180	2249	2323	2398	2472	2565	2654	2754	2904	3029	3149	2733	2822	3246	3534	3808
				M	23.5W x 26.5D x 38.5-45.5H	1.5	24	2190	2263	2333	2402	2476	2552	2625	2718	2808	2907	3058	3182	3303	2886	2976	3399	3688	3962
				H	23.5W x 26.5D x 40.75-50.75H	1.5	24	2190	2263	2333	2402	2476	2552	2625	2718	2808	2907	3058	3182	3303	2886	2976	3399	3688	3962

To Order Select Below

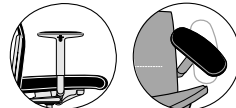



<p>1. Series/Back/Style</p> <p>SV46</p> <p>Sava Chair Medium Back, Standard Upholstery Back, Upholstered Seat</p>	<p>2. Control</p> <p>2 CONFERENCE MECHANISM</p> <p>Adjustments Preset Recline Tension Pneumatic Seat Height Tilt Lock</p>	<p>3. Arm</p> <p>00 ARMLESS 01 HEIGHT ADJUSTABLE ARMS 05 FIXED HEIGHT T-ARM 07 FIXED HEIGHT D-ARM</p> <p> Armless  T-Arm  D-Arm</p> <p> Height Adjustable Arms</p> <p>Height adjustable arms come standard with 45° inward rotation and urethane caps.</p>	<p>4. Options</p> <p>01UC UPHOLSTERED ARM CAP FOR HEIGHT ADJUSTABLE ARM +72</p> <p>05UC UPHOLSTERED ARM CAP FOR T-ARM +72</p> <p>07UC UPHOLSTERED ARM CAP FOR D-ARM +173</p> <p>AC BLACK PLASTIC ARM CAP FOR D-ARM +32</p> <p>CT CONTRASTING THREAD</p> <p>Upholstered arm caps must be leather, vinyl, or polyurethane. Height adjustment lock-out comes standard on all Sava chairs.</p>	<p>5. Stool</p> <p>M COUNTER STOOL</p> <p>H BAR STOOL</p> <p>Stool Heights available with Medium Back only.</p>	<p>7. Caster</p> <p>BC BLACK HARD WHEEL BS BLACK SOFT WHEEL +42 CC CHROME TRIM +98 CS CHROME TRIM SOFT WHEEL +123 GA GLIDES W/ABS PADS +98 GF GLIDES W/FELT PADS +98</p>	<p>8. Arm Finish</p> <p>AL POLISHED ALUMINUM CH CHROME +473</p> <p>Chrome finish is only available on Fixed Height D-Arms (07)</p>	<p>8. Upholstery</p> <p>See general information section for details on textile program and COM/ COL information.</p>
---	---	---	---	--	--	--	---

Sava

MEDIUM BACK: STANDARD UPHOLSTERY BACK, UPHOLSTERED SEAT, MULTI-TASK MECHANISM

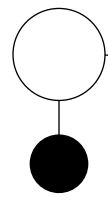
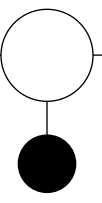
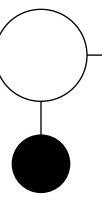
TITLE	STYLE	CTRL	ARM	HEIGHT	DIMENSIONS	YDG	SQFT	Textile Upholstery Grades										Leather Upholstery Grades							
								COM	COL	COM	COL	A	B	C	D	E	F	G	H	I	J	K	L	M	W
 <p>Medium Back, Standard Upholstery Back, Upholstered Seat, Multi-Task Mechanism</p>	Armless	4	00		19W x 26.5D x 33-38H	1.5	24	1990	2063	2135	2205	2277	2354	2428	2519	2608	2707	2859	2983	3103	2689	2778	3198	3488	3761
				M	19W x 26.5D x 38.5-45.5H	1.5	24	2143	2217	2288	2358	2431	2507	2581	2672	2762	2860	3012	3136	3256	2842	2932	3352	3641	3914
				H	19W x 26.5D x 40.75-50.75H	1.5	24	2143	2217	2288	2358	2431	2507	2581	2672	2762	2860	3012	3136	3256	2842	2932	3352	3641	3914
	Adjustable Arm	4	01		27.5W x 26.5D x 33-38H	1.5	24	2444	2519	2590	2660	2732	2809	2882	2974	3064	3164	3315	3439	3560	3145	3232	3679	3968	4242
				M	27.5W x 26.5D x 38.5-45.5H	1.5	24	2598	2672	2744	2813	2885	2962	3036	3127	3217	3317	3468	3592	3713	3298	3385	3833	4121	4395
				H	27.5W x 26.5D x 40.75-50.75H	1.5	24	2598	2672	2744	2813	2885	2962	3036	3127	3217	3317	3468	3592	3713	3298	3385	3833	4121	4395
	Fixed T-Arm	4	05		27.5W x 26.5D x 33-38H	1.5	24	2227	2298	2370	2441	2515	2590	2664	2754	2846	2944	3096	3220	3341	2925	3016	3446	3738	4012
				M	27.5W x 26.5D x 38.5-45.5H	1.5	24	2380	2452	2523	2595	2668	2744	2817	2907	2999	3098	3249	3374	3494	3079	3169	3599	3891	4165
				H	27.5W x 26.5D x 40.75-50.75H	1.5	24	2380	2452	2523	2595	2668	2744	2817	2907	2999	3098	3249	3374	3494	3079	3169	3599	3891	4165
	Fixed D-Arm	4	07		23.5W x 26.5D x 33-38H	1.5	24	2158	2230	2302	2372	2443	2520	2594	2685	2776	2876	3026	3151	3271	2855	2946	3375	3663	3938
				M	23.5W x 26.5D x 38.5-45.5H	1.5	24	2311	2384	2455	2525	2597	2673	2747	2838	2930	3029	3179	3304	3424	3008	3100	3528	3817	4091
				H	23.5W x 26.5D x 40.75-50.75H	1.5	24	2311	2384	2455	2525	2597	2673	2747	2838	2930	3029	3179	3304	3424	3008	3100	3528	3817	4091

To Order Select Below

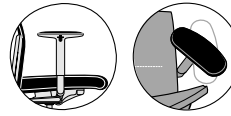
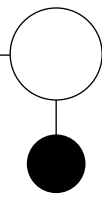
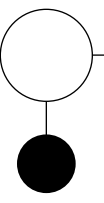
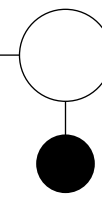
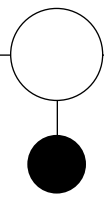
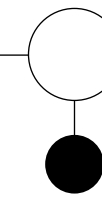

<p>1. Series/Back/Style</p>  <p>SV46</p> <p>Sava Chair Medium Back, Standard Upholstery Back, Upholstered Seat</p>	<p>2. Control</p>  <p>Control</p> <p>4 MULTI-TASK MECHANISM</p> <p>Adjustments 4-Position Tilt Tension Pneumatic Seat Height Tilt Lock Seat Depth</p>	<p>3. Arm</p>  <p>Arm</p> <p>00 ARMLESS 01 HEIGHT ADJUSTABLE ARMS 05 FIXED HEIGHT T-ARM 07 FIXED HEIGHT D-ARM</p> <p> Armless  T-Arm  D-Arm</p> <p> Height Adjustable Arms</p> <p>Height adjustable arms come standard with 45° inward rotation and urethane caps.</p>	<p>4. Options</p>  <p>Options</p> <p>01UC UPHOLSTERED ARM CAP FOR HEIGHT ADJUSTABLE ARM +72</p> <p>05UC UPHOLSTERED ARM CAP FOR T-ARM +72</p> <p>07UC UPHOLSTERED ARM CAP FOR D-ARM +173</p> <p>AC BLACK PLASTIC ARM CAP FOR D-ARM +32</p> <p>CT CONTRASTING THREAD</p> <p>Upholstered arm caps must be leather, vinyl, or polyurethane. Height adjustment lock-out comes standard on all Sava chairs.</p>	<p>5. Stool</p>  <p>Stool</p> <p>M COUNTER STOOL H BAR STOOL</p> <p>Stool Heights available with Medium Back only.</p>	<p>7. Caster</p>  <p>Caster</p> <p>BC BLACK HARD WHEEL BS BLACK SOFT WHEEL +42 CC CHROME TRIM +98 CS CHROME TRIM SOFT WHEEL +123 GA GLIDES W/ABS PADS +98 GF GLIDES W/FELT PADS +98</p>	<p>8. Arm Finish</p>  <p>Arm Finish</p> <p>AL POLISHED ALUMINUM CH CHROME +473</p> <p>Chrome finish is only available on Fixed Height D-Arms (07)</p>	<p>8. Upholstery</p>  <p>See general information section for details on textile program and COM/ COL information.</p>
--	---	---	---	---	---	---	--

Sava

MEDIUM BACK: STANDARD UPHOLSTERY BACK, UPHOLSTERED SEAT, SINGLE PADDLE MECHANISM

TITLE	STYLE	CTRL	ARM	HEIGHT	DIMENSIONS	YDG	SQFT	Textile Upholstery Grades				Leather Upholstery Grades													
								COM	COL	COM	COL	A	B	C	D	E	F	G	H	I	J	K	L	M	W
 <p>Medium Back, Standard Upholstery Back, Upholstered Seat, Single Paddle Mechanism</p>	Armless	1	00		19W x 26.5D x 33-38H	1.5	24	1586	1658	1729	1801	1873	1948	2022	2113	2205	2305	2455	2580	2700	2284	2373	2768	3060	3332
				M	19W x 26.5D x 38.5-45.5H	1.5	24	1739	1811	1883	1954	2027	2101	2176	2266	2358	2458	2608	2733	2853	2437	2526	2921	3213	3485
				H	19W x 26.5D x 40.75-50.75H	1.5	24	1739	1811	1883	1954	2027	2101	2176	2266	2358	2458	2608	2733	2853	2437	2526	2921	3213	3485
	Adjustable Arm	1	01		27.5W x 26.5D x 33-38H	1.5	24	2041	2113	2184	2255	2329	2405	2479	2568	2660	2758	2910	3034	3155	2739	2829	3250	3543	3814
				M	27.5W x 26.5D x 38.5-45.5H	1.5	24	2195	2266	2337	2409	2482	2558	2632	2722	2813	2912	3063	3188	3308	2893	2982	3403	3696	3967
				H	27.5W x 26.5D x 40.75-50.75H	1.5	24	2195	2266	2337	2409	2482	2558	2632	2722	2813	2912	3063	3188	3308	2893	2982	3403	3696	3967
	Fixed T-Arm	1	05		27.5W x 26.5D x 33-38H	1.5	24	1823	1895	1968	2037	2109	2184	2260	2350	2441	2540	2691	2815	2935	2521	2609	3019	3309	3582
				M	27.5W x 26.5D x 38.5-45.5H	1.5	24	1976	2049	2121	2190	2263	2337	2413	2503	2595	2693	2844	2968	3088	2674	2763	3172	3462	3735
				H	27.5W x 26.5D x 40.75-50.75H	1.5	24	1976	2049	2121	2190	2263	2337	2413	2503	2595	2693	2844	2968	3088	2674	2763	3172	3462	3735
	Fixed D-Arm	1	07		23.5W x 26.5D x 33-38H	1.5	24	1755	1826	1896	1968	2040	2115	2191	2282	2370	2471	2621	2745	2866	2452	2540	2946	3235	3509
				M	23.5W x 26.5D x 38.5-45.5H	1.5	24	1908	1979	2050	2121	2193	2268	2345	2435	2523	2624	2774	2899	3019	2605	2693	3100	3388	3662
				H	23.5W x 26.5D x 40.75-50.75H	1.5	24	1908	1979	2050	2121	2193	2268	2345	2435	2523	2624	2774	2899	3019	2605	2693	3100	3388	3662

To Order Select Below

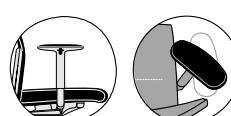

<p>1. Series/Back/Style</p> <p>SV46</p> <p>Sava Chair Medium Back, Standard Upholstery Back, Upholstered Seat</p>	<p>2. Control</p> <p>1 SINGLE PADDLE MECHANISM</p> <p>Adjustments Preset Recline Tension Pneumatic Seat Height</p>	<p>3. Arm</p> <p>00 ARMLESS 01 HEIGHT ADJUSTABLE ARMS 05 FIXED HEIGHT T-ARM 07 FIXED HEIGHT D-ARM</p> <p> Armless  T-Arm  D-Arm</p> <p> Height Adjustable Arms</p> <p>Height adjustable arms come standard with 45° inward rotation and urethane caps.</p>	<p>4. Options</p> <p>01UC UPHOLSTERED ARM CAP FOR HEIGHT ADJUSTABLE ARM +72</p> <p>05UC UPHOLSTERED ARM CAP FOR T-ARM +72</p> <p>07UC UPHOLSTERED ARM CAP FOR D-ARM +173</p> <p>AC BLACK PLASTIC ARM CAP FOR D-ARM +32</p> <p>CT CONTRASTING THREAD</p> <p>Upholstered arm caps must be leather, vinyl, or polyurethane. Height adjustment lock-out comes standard on all Sava chairs.</p>	<p>5. Stool</p> <p>M COUNTER STOOL</p> <p>H BAR STOOL</p> <p>Stool Heights available with Medium Back only.</p>	<p>7. Caster</p> <p>BC BLACK HARD WHEEL BS BLACK SOFT WHEEL +42 CC CHROME TRIM +98 CS CHROME TRIM SOFT WHEEL +123 GA GLIDES W/ABS PADS +98 GF GLIDES W/FELT PADS +98</p>	<p>7. Arm Finish</p> <p>AL POLISHED ALUMINUM CH CHROME +473 BM BLACK MATTE</p> <p>Chrome finish is only available on Fixed Height D-Arms (07)</p> <p>Black Matte finish is only available on the Single Paddle control. Black Matte finish on arms is only available on Fixed Height T-Arm (05) or D-Arm (07).</p>	<p>8. Upholstery</p> <p>See general information section for details on textile program and COM/ COL information.</p>
---	--	---	---	--	--	--	---

Sava

MEDIUM BACK: EURO UPHOLSTERY BACK, EURO UPHOLSTERY SEAT, CONFERENCE MECHANISM

TITLE	STYLE	CTRL	ARM	HEIGHT	DIMENSIONS	YDG	SQFT	Textile Upholstery Grades										Leather Upholstery Grades								
								COM	COL	COM	COL	A	B	C	D	E	F	G	H	I	J	K	L	M	W	X
 Medium Back, Euro Upholstery Back, Euro Upholstered Seat, Conference Mechanism	Armless	SV56	2	00		19W x 26.5D x 33-38H	1.5	24	1870	1943	2013	2083	2156	2231	2307	2397	2490	2586	2738	2862	2983	2567	2657	3068	3360	3631
		SV56	2	00	M	19W x 26.5D x 38.5-45.5H	1.5	24	2023	2096	2166	2237	2309	2385	2460	2550	2643	2739	2891	3015	3136	2721	2810	3221	3513	3784
		SV56	2	00	H	19W x 26.5D x 40.75-50.75H	1.5	24	2023	2096	2166	2237	2309	2385	2460	2550	2643	2739	2891	3015	3136	2721	2810	3221	3513	3784
	Adjustable Arm	SV56	2	01		27.5W x 26.5D x 33-38H	1.5	24	2324	2397	2469	2539	2611	2687	2764	2852	2943	3043	3194	3319	3439	3022	3113	3549	3842	4113
		SV56	2	01	M	27.5W x 26.5D x 38.5-45.5H	1.5	24	2477	2550	2622	2692	2765	2840	2917	3005	3096	3196	3347	3472	3592	3175	3267	3702	3995	4266
		SV56	2	01	H	27.5W x 26.5D x 40.75-50.75H	1.5	24	2477	2550	2622	2692	2765	2840	2917	3005	3096	3196	3347	3472	3592	3175	3267	3702	3995	4266
	Fixed T-Arm	SV56	2	05		27.5W x 26.5D x 33-38H	1.5	24	2106	2179	2249	2321	2393	2469	2542	2633	2724	2822	2973	3097	3218	2804	2893	3318	3610	3882
		SV56	2	05	M	27.5W x 26.5D x 38.5-45.5H	1.5	24	2260	2332	2402	2474	2546	2622	2695	2787	2877	2976	3127	3251	3371	2957	3046	3471	3763	4035
		SV56	2	05	H	27.5W x 26.5D x 40.75-50.75H	1.5	24	2260	2332	2402	2474	2546	2622	2695	2787	2877	2976	3127	3251	3371	2957	3046	3471	3763	4035
	Fixed D-Arm	SV56	2	07		23.5W x 26.5D x 33-38H	1.5	24	2037	2109	2180	2249	2323	2398	2472	2565	2654	2754	2904	3029	3149	2733	2822	3246	3534	3808
		SV56	2	07	M	23.5W x 26.5D x 38.5-45.5H	1.5	24	2190	2263	2333	2402	2476	2552	2625	2718	2808	2907	3058	3182	3303	2886	2976	3399	3688	3962
		SV56	2	07	H	23.5W x 26.5D x 40.75-50.75H	1.5	24	2190	2263	2333	2402	2476	2552	2625	2718	2808	2907	3058	3182	3303	2886	2976	3399	3688	3962

To Order Select Below

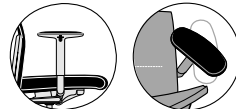



<p>1. Series/Back/Style</p> <p>SV56</p> <p>Sava Chair, Medium Back, Euro Upholstery Back, Euro Upholstered Seat</p>	<p>2. Control</p> <p>2 CONFERENCE MECHANISM</p> <p>Adjustments Preset Recline Tension Pneumatic Seat Height Tilt Lock</p>	<p>3. Arm</p> <p>00 ARMLESS 01 HEIGHT ADJUSTABLE ARMS 05 FIXED HEIGHT T-ARM 07 FIXED HEIGHT D-ARM</p> <p> Armless  T-Arm  D-Arm</p> <p> Height Adjustable Arms</p> <p>Height adjustable arms come standard with 45° inward rotation and urethane caps.</p>	<p>4. Options</p> <p>01UC UPHOLSTERED ARM CAP FOR HEIGHT ADJUSTABLE ARM +72</p> <p>05UC UPHOLSTERED ARM CAP FOR T-ARM +72</p> <p>07UC UPHOLSTERED ARM CAP FOR D-ARM +173</p> <p>AC BLACK PLASTIC ARM CAP FOR D-ARM +32</p> <p>CT CONTRASTING THREAD</p> <p>Upholstered arm caps must be leather, vinyl, or polyurethane. Height adjustment lock-out comes standard on all Sava chairs.</p>	<p>5. Stool</p> <p>M COUNTER STOOL</p> <p>H BAR STOOL</p> <p>Stool Heights available with Medium Back only.</p>	<p>7. Caster</p> <p>BC BLACK HARD WHEEL BS BLACK SOFT WHEEL +42 CC CHROME TRIM +98 CS CHROME TRIM SOFT WHEEL +123 GA GLIDES W/ABS PADS +98 GF GLIDES W/FELT PADS +98</p>	<p>8. Arm Finish</p> <p>AL POLISHED ALUMINUM CH CHROME +473</p> <p>Chrome finish is only available on Fixed Height D-Arms (07)</p>	<p>8. Upholstery</p> <p>See general information section for details on textile program and COM/ COL information.</p>
---	---	---	---	--	--	--	---

Sava

MEDIUM BACK: EURO UPHOLSTERY BACK, EURO UPHOLSTERY SEAT, MULTI-TASK MECHANISM

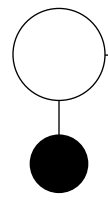
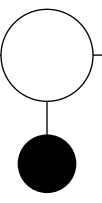
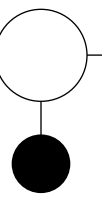
TITLE	STYLE	CTRL	ARM	HEIGHT	DIMENSIONS	YDG	SQFT	Textile Upholstery Grades										Leather Upholstery Grades								
								COM	COL	COM	COL	A	B	C	D	E	F	G	H	I	J	K	L	M	W	X
 Medium Back, Euro Upholstery Back, Euro Upholstery Seat, Multi-Task Mechanism	Armless	SV56	4	00		19W x 26.5D x 33-38H	1.5	24	1990	2063	2135	2205	2277	2354	2428	2519	2608	2707	2859	2983	3103	2689	2778	3198	3488	3761
		SV56	4	00	M	19W x 26.5D x 38.5-45.5H	1.5	24	2143	2217	2288	2358	2431	2507	2581	2672	2762	2860	3012	3136	3256	2842	2932	3352	3641	3914
		SV56	4	00	H	19W x 26.5D x 40.75-50.75H	1.5	24	2143	2217	2288	2358	2431	2507	2581	2672	2762	2860	3012	3136	3256	2842	2932	3352	3641	3914
	Adjustable Arm	SV56	4	01		27.5W x 26.5D x 33-38H	1.5	24	2444	2519	2590	2660	2732	2809	2882	2974	3064	3164	3315	3439	3560	3145	3232	3679	3968	4242
		SV56	4	01	M	27.5W x 26.5D x 38.5-45.5H	1.5	24	2598	2672	2744	2813	2885	2962	3036	3127	3217	3317	3468	3592	3713	3298	3385	3833	4121	4395
		SV56	4	01	H	27.5W x 26.5D x 40.75-50.75H	1.5	24	2598	2672	2744	2813	2885	2962	3036	3127	3217	3317	3468	3592	3713	3298	3385	3833	4121	4395
	Fixed T-Arm	SV56	4	05		27.5W x 26.5D x 33-38H	1.5	24	2227	2298	2370	2441	2515	2590	2664	2754	2846	2944	3096	3220	3341	2925	3016	3446	3738	4012
		SV56	4	05	M	27.5W x 26.5D x 38.5-45.5H	1.5	24	2380	2452	2523	2595	2668	2744	2817	2907	2999	3098	3249	3374	3494	3079	3169	3599	3891	4165
		SV56	4	05	H	27.5W x 26.5D x 40.75-50.75H	1.5	24	2380	2452	2523	2595	2668	2744	2817	2907	2999	3098	3249	3374	3494	3079	3169	3599	3891	4165
	Fixed D-Arm	SV56	4	07		23.5W x 26.5D x 33-38H	1.5	24	2158	2230	2302	2372	2443	2520	2594	2685	2776	2876	3026	3151	3271	2855	2946	3375	3663	3938
		SV56	4	07	M	23.5W x 26.5D x 38.5-45.5H	1.5	24	2311	2384	2455	2525	2597	2673	2747	2838	2930	3029	3179	3304	3424	3008	3100	3528	3817	4091
		SV56	4	07	H	23.5W x 26.5D x 40.75-50.75H	1.5	24	2311	2384	2455	2525	2597	2673	2747	2838	2930	3029	3179	3304	3424	3008	3100	3528	3817	4091

To Order Select Below

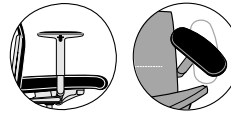
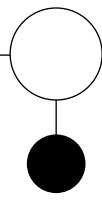
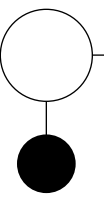
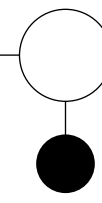
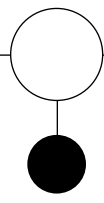
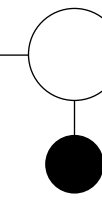





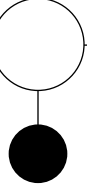
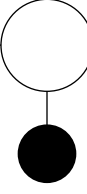
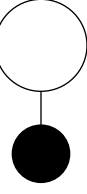

<p>1. Series/Back/Style</p>  <p>SV56</p> <p>Sava Chair, Medium Back, Euro Upholstery Back, Euro Upholstery Seat</p>	<p>2. Control</p>  <p>Control</p> <p>4 MULTI-TASK MECHANISM</p> <p>Adjustments 4-Position Tilt Tension Pneumatic Seat Height Tilt Lock Seat Depth</p>	<p>3. Arm</p>  <p>Arm</p> <p>00 ARMLESS 01 HEIGHT ADJUSTABLE ARMS 05 FIXED HEIGHT T-ARM 07 FIXED HEIGHT D-ARM</p> <p> Armless  T-Arm  D-Arm</p> <p> Height Adjustable Arms</p> <p>Height adjustable arms come standard with 45° inward rotation and urethane caps.</p>	<p>4. Options</p>  <p>Options</p> <p>01UC UPHOLSTERED ARM CAP FOR HEIGHT ADJUSTABLE ARM +72</p> <p>05UC UPHOLSTERED ARM CAP FOR T-ARM +72</p> <p>07UC UPHOLSTERED ARM CAP FOR D-ARM +173</p> <p>AC BLACK PLASTIC ARM CAP FOR D-ARM +32</p> <p>CT CONTRASTING THREAD</p> <p>Upholstered arm caps must be leather, vinyl, or polyurethane. Height adjustment lock-out comes standard on all Sava chairs.</p>	<p>5. Stool</p>  <p>Stool</p> <p>M COUNTER STOOL H BAR STOOL</p> <p>Stool Heights available with Medium Back only.</p>	<p>7. Caster</p>  <p>Caster</p> <p>BC BLACK HARD WHEEL BS BLACK SOFT WHEEL +42 CC CHROME TRIM +98 CS CHROME TRIM SOFT WHEEL +123 GA GLIDES W/ABS PADS +98 GF GLIDES W/FELT PADS +98</p>	<p>8. Arm Finish</p>  <p>Arm Finish</p> <p>AL POLISHED ALUMINUM CH CHROME +473</p> <p>Chrome finish is only available on Fixed Height D-Arms (07)</p>	<p>8. Upholstery</p>  <p>See general information section for details on textile program and COM/ COL information.</p>
---	---	---	---	---	---	---	--

Sava

MEDIUM BACK: EURO UPHOLSTERY BACK, EURO UPHOLSTERY SEAT, SINGLE PADDLE MECHANISM

TITLE	STYLE	CTRL	ARM	HEIGHT	DIMENSIONS	YDG	SQFT	Textile Upholstery Grades										Leather Upholstery Grades								
								COM	COL	COM	COL	A	B	C	D	E	F	G	H	I	J	K	L	M	W	X
	Armless	SV56	1	00		19W x 26.5D x 33-38H	1.5	24	1586	1658	1729	1801	1873	1948	2022	2113	2205	2305	2455	2580	2700	2284	2373	2768	3060	3332
		SV56	1	00	M	19W x 26.5D x 38.5-45.5H	1.5	24	1739	1811	1883	1954	2027	2101	2176	2266	2358	2458	2608	2733	2853	2437	2526	2921	3213	3485
		SV56	1	00	H	19W x 26.5D x 40.75-50.75H	1.5	24	1739	1811	1883	1954	2027	2101	2176	2266	2358	2458	2608	2733	2853	2437	2526	2921	3213	3485
	Adjustable Arm	SV56	1	01		27.5W x 26.5D x 33-38H	1.5	24	2041	2113	2184	2255	2329	2405	2479	2568	2660	2758	2910	3034	3155	2739	2829	3250	3543	3814
		SV56	1	01	M	27.5W x 26.5D x 38.5-45.5H	1.5	24	2195	2266	2337	2409	2482	2558	2632	2722	2813	2912	3063	3188	3308	2893	2982	3403	3696	3967
		SV56	1	01	H	27.5W x 26.5D x 40.75-50.75H	1.5	24	2195	2266	2337	2409	2482	2558	2632	2722	2813	2912	3063	3188	3308	2893	2982	3403	3696	3967
	Fixed T-Arm	SV56	1	05		27.5W x 26.5D x 33-38H	1.5	24	1823	1895	1968	2037	2109	2184	2260	2350	2441	2540	2691	2815	2935	2521	2609	3019	3309	3582
		SV56	1	05	M	27.5W x 26.5D x 38.5-45.5H	1.5	24	1976	2049	2121	2190	2263	2337	2413	2503	2595	2693	2844	2968	3088	2674	2763	3172	3462	3735
		SV56	1	05	H	27.5W x 26.5D x 40.75-50.75H	1.5	24	1976	2049	2121	2190	2263	2337	2413	2503	2595	2693	2844	2968	3088	2674	2763	3172	3462	3735
	Fixed D-Arm	SV56	1	07		23.5W x 26.5D x 33-38H	1.5	24	1755	1826	1896	1968	2040	2115	2191	2282	2370	2471	2621	2745	2866	2452	2540	2946	3235	3509
		SV56	1	07	M	23.5W x 26.5D x 38.5-45.5H	1.5	24	1908	1979	2050	2121	2193	2268	2345	2435	2523	2624	2774	2899	3019	2605	2693	3100	3388	3662
		SV56	1	07	H	23.5W x 26.5D x 40.75-50.75H	1.5	24	1908	1979	2050	2121	2193	2268	2345	2435	2523	2624	2774	2899	3019	2605	2693	3100	3388	3662

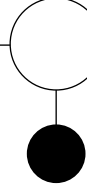
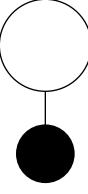
To Order Select Below

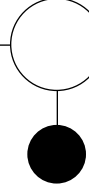
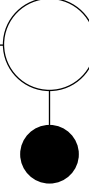
<p>1. Series/Back/Style</p>  <p>SV56</p> <p>Sava Chair Medium Back, Euro Upholstery Back, Euro Upholstery Seat</p>	<p>2. Control</p>  <p>Control</p> <p>1 SINGLE PADDLE MECHANISM</p> <p>Adjustments Preset Recline Tension Pneumatic Seat Height</p>	<p>3. Arm</p>  <p>Arm</p> <p>00 ARMLESS</p> <p>01 HEIGHT ADJUSTABLE ARMS</p> <p>05 FIXED HEIGHT T-ARM</p> <p>07 FIXED HEIGHT D-ARM</p> <div style="display: flex; justify-content: space-around; margin-top: 10px;">  Armless  T-Arm  D-Arm </div> <div style="display: flex; justify-content: space-around; margin-top: 10px;">   Height Adjustable Arms </div> <p>Height adjustable arms come standard with 45° inward rotation and urethane caps.</p>	<p>4. Options</p>  <p>Options</p> <p>01UC UPHOLSTERED ARM CAP FOR HEIGHT ADJUSTABLE ARM +72</p> <p>05UC UPHOLSTERED ARM CAP FOR T-ARM +72</p> <p>07UC UPHOLSTERED ARM CAP FOR D-ARM +173</p> <p>AC BLACK PLASTIC ARM CAP FOR D-ARM +32</p> <p>CT CONTRASTING THREAD</p> <p>Upholstered arm caps must be leather, vinyl, or polyurethane. Height adjustment lock-out comes standard on all Sava chairs.</p>	<p>5. Stool</p>  <p>Stool</p> <p>M COUNTER STOOL</p> <p>H BAR STOOL</p> <p>Stool Heights available with Medium Back only.</p>	<p>7. Caster</p>  <p>Caster</p> <p>BC BLACK HARD WHEEL</p> <p>BS BLACK SOFT WHEEL +42</p> <p>CC CHROME TRIM +98</p> <p>CS CHROME TRIM SOFT WHEEL +123</p> <p>GA GLIDES W/ABS PADS +98</p> <p>GF GLIDES W/FELT PADS +98</p>	<p>7. Arm Finish</p>  <p>Arm Finish</p> <p>AL POLISHED ALUMINUM</p> <p>CH CHROME +473</p> <p>BM BLACK MATTE</p> <p>Chrome finish is only available on Fixed Height D-Arms (07)</p> <p>Black Matte finish is only available on the Single Paddle control. Black Matte finish on arms is only available on Fixed Height T-Arm (05) or D-Arm (07).</p>	<p>8. Upholstery</p>  <p>See general information section for details on textile program and COM/ COL information.</p>
--	--	--	---	--	--	---	--

Sava

HIGH BACK: MESH BACK, MESH SEAT

TITLE	STYLE	CTRL	ARM	HEIGHT	DIMENSIONS	YDG	SQFT	Textile Upholstery Grades										Leather Upholstery Grades							
								COM	COL	COM	COL	A	B	C	D	E	F	G	H	I	J	K	L	M	W
High Back, Mesh Back, Mesh Seat, Conference Mechanism	Armless	SV18	2	00	19W x 26.5D x 37.5-42.5H	0	0	1884																	
	Adjustable Arm	SV18	2	01	27.5W x 26.5D x 37.5-42.5H	0	0	2330																	
	Fixed T-Arm	SV18	2	05	27.5W x 26.5D x 37.5-42.5H	0	0	2116																	
	Fixed D-Arm	SV18	2	07	23.5W x 26.5D x 37.5-42.5H	0	0	2046																	
High Back, Mesh Back, Mesh Seat, Single Paddle Mechanism	Armless	SV18	1	00	19W x 26.5D x 37.5-42.5H	0	0	1607																	
	Adjustable Arm	SV18	1	01	27.5W x 26.5D x 37.5-42.5H	0	0	2053																	
	Fixed T-Arm	SV18	1	05	27.5W x 26.5D x 37.5-42.5H	0	0	1838																	
	Fixed D-Arm	SV18	1	07	23.5W x 26.5D x 37.5-42.5H	0	0	1769																	

To Order Select Below

1. Series/Back/Style

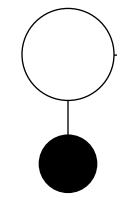

SV18

Sava Chair High Back, Mesh Back, Mesh Seat

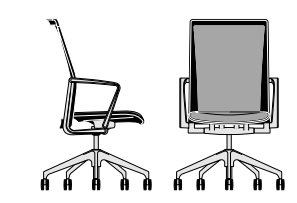

2. Control

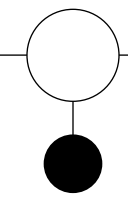

Control

2	CONFERENCE MECHANISM
1	SINGLE PADDLE MECHANISM

Conference Adjustments
Preset Recline Tension
Pneumatic Seat Height
Tilt Lock

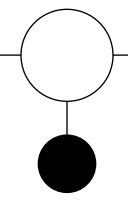

Single Paddle Adjustments
Preset Recline Tension
Pneumatic Seat Height

3. Arm



Arm

00	ARMLESS
01	HEIGHT ADJUSTABLE ARMS
05	FIXED HEIGHT T-ARM
07	FIXED HEIGHT D-ARM

 **Armless**
 **T-Arm**
 **D-Arm**

 **Height Adjustable Arms**

Height adjustable arms come standard with 45° inward rotation and urethane caps.

4. Mesh

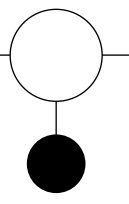

Mesh

M1	BLACK
M2	BRONZE
M3	SILVER WHITE
M4	WARM GRAY

5. Options

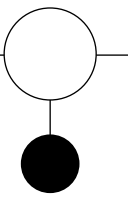

Options

01UC	UPHOLSTERED ARM CAP FOR HEIGHT ADJUSTABLE ARM	+72
05UC	UPHOLSTERED ARM CAP FOR T-ARM	+72
07UC	UPHOLSTERED ARM CAP FOR D-ARM	+173
AC	BLACK PLASTIC ARM CAP FOR D-ARM	+32
LU	ADJUSTABLE LUMBAR PADS	+58

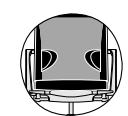

Adjustable lumbar pads for Mesh Backs

Upholstered arm caps must be leather, vinyl, or polyurethane. Height adjustment lock-out comes standard on all Sava chairs.

6. Caster

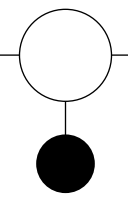

Caster

BC	BLACK HARD WHEEL
BS	BLACK SOFT WHEEL +42
CC	CHROME TRIM +98
CS	CHROME TRIM SOFT WHEEL +123
GA	GLIDES W/ABS PADS +98
GF	GLIDES W/FELT PADS +98

7. Arm Finish

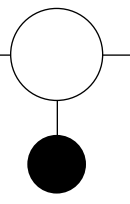

Arm Finish

AL	POLISHED ALUMINUM
CH	CHROME +473
BM	BLACK MATTE

Chrome finish is only available on Fixed Height D-Arms (07)

Black Matte finish is only available on the Single Paddle control. Black Matte finish on arms is only available on Fixed Height T-Arm (05) or D-Arm (07).

8. Upholstery

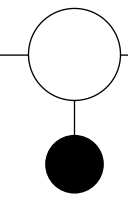







See general information section for details on textile program and COM/ COL information.

Sava

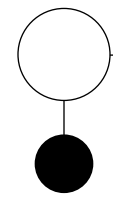
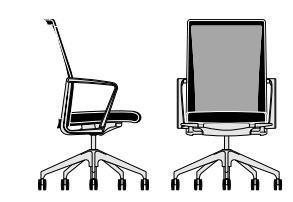
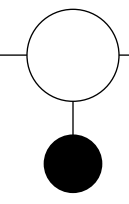
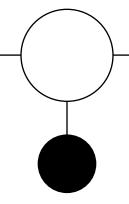
HIGH BACK: MESH BACK, UPHOLSTERED SEAT

TITLE	STYLE	CTRL	ARM	HEIGHT	DIMENSIONS	YDG	SQFT	Textile Upholstery Grades										Leather Upholstery Grades								
								COM	COL	COM	COL	A	B	C	D	E	F	G	H	I	J	K	L	M	W	X
High Back, Mesh Back, Upholstered Seat, Conference Mechanism	Armless	SV28	2	00		19W x 26.5D x 37.5-42.5H	0.8	10	1696	1730	1769	1808	1845	1884	1922	1970	2016	2070	2148	2213	2276	1959	1998	2218	2306	2452
	Adjustable Arm	SV28	2	01		27.5W x 26.5D x 37.5-42.5H	0.8	10	2141	2180	2216	2253	2291	2330	2369	2418	2462	2518	2595	2660	2723	2407	2443	2691	2778	2922
	Fixed T-Arm	SV28	2	05		27.5W x 26.5D x 37.5-42.5H	0.8	10	1928	1962	2000	2038	2078	2116	2155	2202	2248	2302	2380	2445	2508	2193	2230	2464	2553	2695
	Fixed D-Arm	SV28	2	07		23.5W x 26.5D x 37.5-42.5H	0.8	10	1857	1895	1933	1970	2007	2046	2085	2133	2181	2233	2312	2377	2440	2125	2161	2392	2478	2624
High Back, Mesh Back, Upholstered Seat, Multi-Task Mechanism	Armless	SV28	4	00		19W x 26.5D x 37.5-42.5H	0.8	10	1813	1851	1888	1925	1960	2002	2042	2087	2135	2187	2265	2330	2393	2081	2117	2343	2432	2575
	Adjustable Arm	SV28	4	01		27.5W x 26.5D x 37.5-42.5H	0.8	10	2260	2297	2334	2371	2408	2450	2490	2535	2582	2634	2713	2778	2841	2527	2564	2818	2905	3046
	Fixed T-Arm	SV28	4	05		27.5W x 26.5D x 37.5-42.5H	0.8	10	2045	2083	2121	2158	2195	2234	2272	2322	2367	2421	2499	2564	2627	2312	2349	2590	2678	2821
	Fixed D-Arm	SV28	4	07		23.5W x 26.5D x 37.5-42.5H	0.8	10	1978	2013	2051	2087	2127	2166	2205	2253	2298	2353	2431	2496	2559	2242	2281	2519	2604	2748
High Back, Mesh Back, Upholstered Seat, Single Paddle Mechanism	Armless	SV28	1	00		19W x 26.5D x 37.5-42.5H	0.8	10	1419	1454	1491	1529	1566	1607	1644	1692	1739	1791	1869	1934	1997	1683	1720	1924	2012	2156
	Adjustable Arm	SV28	1	01		27.5W x 26.5D x 37.5-42.5H	0.8	10	1862	1901	1937	1975	2012	2053	2092	2138	2184	2238	2316	2381	2444	2129	2167	2396	2484	2628
	Fixed T-Arm	SV28	1	05		27.5W x 26.5D x 37.5-42.5H	0.8	10	1650	1685	1723	1760	1798	1838	1877	1924	1970	2023	2101	2166	2229	1915	1953	2169	2258	2401
	Fixed D-Arm	SV28	1	07		23.5W x 26.5D x 37.5-42.5H	0.8	10	1581	1618	1656	1692	1728	1769	1809	1855	1903	1955	2033	2098	2161	1847	1884	2097	2184	2330

To Order Select Below

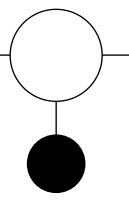
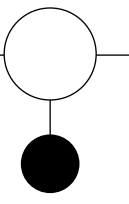
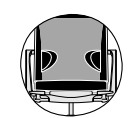
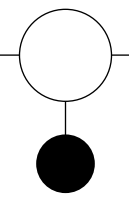
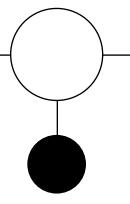
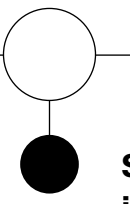



<p>1. Series/Back/Style</p>  <p>SV28</p> <p>Sava Chair High Back, Mesh Back, Upholstered Seat</p> 	<p>2. Control</p>  <p>Control</p> <table border="0"> <tr> <td>2</td> <td>CONFERENCE MECHANISM</td> </tr> <tr> <td>4</td> <td>MULTI-TASK MECHANISM</td> </tr> <tr> <td>1</td> <td>SINGLE PADDLE MECHANISM</td> </tr> </table> <p>Conference Adjustments Preset Recline Tension Pneumatic Seat Height Tilt Lock</p> <p>Multi-Task Adjustments 4-Position Tilt Tension Pneumatic Seat Height Tilt Lock Seat Depth</p> <p>Single Paddle Adjustments Preset Recline Tension Pneumatic Seat Height</p>	2	CONFERENCE MECHANISM	4	MULTI-TASK MECHANISM	1	SINGLE PADDLE MECHANISM	<p>3. Arm</p>  <p>Arm</p> <table border="0"> <tr> <td>00</td> <td>ARMLESS</td> </tr> <tr> <td>01</td> <td>HEIGHT ADJUSTABLE ARMS</td> </tr> <tr> <td>05</td> <td>FIXED HEIGHT T-ARM</td> </tr> <tr> <td>07</td> <td>FIXED HEIGHT D-ARM</td> </tr> </table> <div style="display: flex; justify-content: space-around; align-items: center;">  Armless  T-Arm  D-Arm </div> <div style="display: flex; justify-content: space-around; align-items: center;">   <p>Height Adjustable Arms</p> </div> <p>Height adjustable arms come standard with 45° inward rotation and urethane caps.</p>	00	ARMLESS	01	HEIGHT ADJUSTABLE ARMS	05	FIXED HEIGHT T-ARM	07	FIXED HEIGHT D-ARM	<p>4. Mesh</p>  <p>Mesh</p> <table border="0"> <tr> <td>M1</td> <td>BLACK</td> </tr> <tr> <td>M2</td> <td>BRONZE</td> </tr> <tr> <td>M3</td> <td>SILVER WHITE</td> </tr> <tr> <td>M4</td> <td>WARM GRAY</td> </tr> </table>	M1	BLACK	M2	BRONZE	M3	SILVER WHITE	M4	WARM GRAY	<p>5. Options</p>  <p>Options</p> <table border="0"> <tr> <td>01UC</td> <td>UPHOLSTERED ARM CAP FOR HEIGHT ADJUSTABLE ARM</td> <td>+72</td> </tr> <tr> <td>05UC</td> <td>UPHOLSTERED ARM CAP FOR T-ARM</td> <td>+72</td> </tr> <tr> <td>07UC</td> <td>UPHOLSTERED ARM CAP FOR D-ARM</td> <td>+173</td> </tr> <tr> <td>AC</td> <td>BLACK PLASTIC ARM CAP FOR D-ARM</td> <td>+32</td> </tr> <tr> <td>LU</td> <td>ADJUSTABLE LUMBAR PADS</td> <td>+58</td> </tr> <tr> <td>CT</td> <td>CONTRASTING THREAD</td> <td></td> </tr> </table>  <p>Adjustable lumbar pads for Mesh Backs</p> <p>Upholstered arm caps must be leather, vinyl, or polyurethane. Height adjustment lock-out comes standard on all Sava chairs.</p>	01UC	UPHOLSTERED ARM CAP FOR HEIGHT ADJUSTABLE ARM	+72	05UC	UPHOLSTERED ARM CAP FOR T-ARM	+72	07UC	UPHOLSTERED ARM CAP FOR D-ARM	+173	AC	BLACK PLASTIC ARM CAP FOR D-ARM	+32	LU	ADJUSTABLE LUMBAR PADS	+58	CT	CONTRASTING THREAD		<p>6. Caster</p>  <p>Caster</p> <table border="0"> <tr> <td>BC</td> <td>BLACK HARD WHEEL</td> </tr> <tr> <td>BS</td> <td>BLACK SOFT WHEEL +42</td> </tr> <tr> <td>CC</td> <td>CHROME TRIM +98</td> </tr> <tr> <td>CS</td> <td>CHROME TRIM SOFT WHEEL +123</td> </tr> <tr> <td>GA</td> <td>GLIDES W/ABS PADS +98</td> </tr> <tr> <td>GF</td> <td>GLIDES W/FELT PADS +98</td> </tr> </table>	BC	BLACK HARD WHEEL	BS	BLACK SOFT WHEEL +42	CC	CHROME TRIM +98	CS	CHROME TRIM SOFT WHEEL +123	GA	GLIDES W/ABS PADS +98	GF	GLIDES W/FELT PADS +98	<p>7. Arm Finish</p>  <p>Arm Finish</p> <table border="0"> <tr> <td>AL</td> <td>POLISHED ALUMINUM</td> </tr> <tr> <td>CH</td> <td>CHROME +473</td> </tr> <tr> <td>BM</td> <td>BLACK MATTE</td> </tr> </table> <p>Chrome finish is only available on Fixed Height D-Arms (07)</p> <p>Black Matte finish is only available on the Single Paddle control. Black Matte finish on arms is only available on Fixed Height T-Arm (05) or D-Arm (07).</p>	AL	POLISHED ALUMINUM	CH	CHROME +473	BM	BLACK MATTE	<p>8. Upholstery</p>  <p>See general information section for details on textile program and COM/ COL information.</p>
2	CONFERENCE MECHANISM																																																																
4	MULTI-TASK MECHANISM																																																																
1	SINGLE PADDLE MECHANISM																																																																
00	ARMLESS																																																																
01	HEIGHT ADJUSTABLE ARMS																																																																
05	FIXED HEIGHT T-ARM																																																																
07	FIXED HEIGHT D-ARM																																																																
M1	BLACK																																																																
M2	BRONZE																																																																
M3	SILVER WHITE																																																																
M4	WARM GRAY																																																																
01UC	UPHOLSTERED ARM CAP FOR HEIGHT ADJUSTABLE ARM	+72																																																															
05UC	UPHOLSTERED ARM CAP FOR T-ARM	+72																																																															
07UC	UPHOLSTERED ARM CAP FOR D-ARM	+173																																																															
AC	BLACK PLASTIC ARM CAP FOR D-ARM	+32																																																															
LU	ADJUSTABLE LUMBAR PADS	+58																																																															
CT	CONTRASTING THREAD																																																																
BC	BLACK HARD WHEEL																																																																
BS	BLACK SOFT WHEEL +42																																																																
CC	CHROME TRIM +98																																																																
CS	CHROME TRIM SOFT WHEEL +123																																																																
GA	GLIDES W/ABS PADS +98																																																																
GF	GLIDES W/FELT PADS +98																																																																
AL	POLISHED ALUMINUM																																																																
CH	CHROME +473																																																																
BM	BLACK MATTE																																																																

Sava

HIGH BACK: STANDARD UPHOLSTERY BACK, UPHOLSTERED SEAT

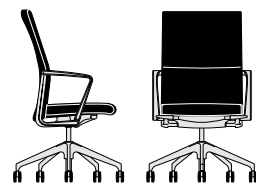
TITLE	STYLE	CTRL	ARM	HEIGHT	DIMENSIONS	YDG	SQFT	Textile Upholstery Grades				Leather Upholstery Grades													
								COM	COL	COM	COL	A	B	C	D	E	F	G	H	I	J	K	L	M	W
High Back, Standard Upholstery Back, Upholstered Seat, Conference Mechanism	Armless	SV48	2	00	19W x 26.5D x 37.5-42.5H	1.7	25	1924	2003	2084	2163	2246	2331	2418	2520	2621	2733	2904	3045	3181	2699	2804	3264	3510	3925
	Adjustable Arm	SV48	2	01	27.5W x 26.5D x 37.5-42.5H	1.7	25	2378	2460	2540	2619	2703	2787	2873	2976	3075	3190	3360	3501	3637	3155	3258	3749	3993	4407
	Fixed T-Arm	SV48	2	05	27.5W x 26.5D x 37.5-42.5H	1.7	25	2160	2241	2322	2399	2483	2567	2654	2755	2858	2972	3141	3282	3418	2936	3042	3514	3761	4176
	Fixed D-Arm	SV48	2	07	23.5W x 26.5D x 37.5-42.5H	1.7	25	2087	2171	2250	2330	2414	2498	2584	2687	2787	2901	3072	3213	3350	2867	2972	3443	3689	4100
High Back, Standard Upholstery Back, Upholstered Seat, Multi-Task Mechanism	Armless	SV48	4	00	19W x 26.5D x 37.5-42.5H	1.7	25	2043	2127	2206	2284	2368	2454	2539	2641	2742	2855	3026	3167	3303	2820	2925	3396	3641	4053
	Adjustable Arm	SV48	4	01	27.5W x 26.5D x 37.5-42.5H	1.7	25	2498	2582	2661	2739	2822	2910	2994	3099	3198	3309	3482	3622	3759	3275	3382	3878	4123	4535
	Fixed T-Arm	SV48	4	05	27.5W x 26.5D x 37.5-42.5H	1.7	25	2280	2363	2442	2521	2605	2690	2776	2879	2978	3091	3262	3403	3539	3057	3161	3645	3892	4304
	Fixed D-Arm	SV48	4	07	23.5W x 26.5D x 37.5-42.5H	1.7	25	2209	2293	2373	2453	2536	2621	2705	2809	2910	3022	3194	3335	3471	2986	3093	3570	3817	4228
High Back, Standard Upholstery Back, Upholstered Seat, Single Paddle Mechanism	Armless	SV48	1	00	19W x 26.5D x 37.5-42.5H	1.7	25	1642	1720	1803	1881	1966	2046	2135	2237	2337	2452	2621	2762	2898	2415	2521	2964	3210	3626
	Adjustable Arm	SV48	1	01	27.5W x 26.5D x 37.5-42.5H	1.7	25	2095	2178	2256	2335	2420	2503	2590	2691	2792	2907	3076	3217	3353	2872	2977	3446	3694	4108
	Fixed T-Arm	SV48	1	05	27.5W x 26.5D x 37.5-42.5H	1.7	25	1877	1956	2038	2116	2200	2284	2370	2472	2574	2687	2857	2998	3134	2653	2756	3215	3462	3875
	Fixed D-Arm	SV48	1	07	23.5W x 26.5D x 37.5-42.5H	1.7	25	1806	1887	1969	2045	2132	2216	2300	2405	2503	2618	2788	2929	3066	2584	2687	3144	3388	3801

To Order Select Below

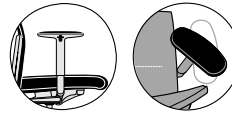
<p>1. Series/Back/Style</p> <p>SV48</p> <p>Sava Chair High Back, Standard Upholstery Back, Upholstered Seat</p> 	<p>2. Control</p> <p>Control</p> <p>2 CONFERENCE MECHANISM</p> <p>4 MULTI-TASK MECHANISM</p> <p>1 SINGLE PADDLE MECHANISM</p> <p>Conference Adjustments Preset Recline Tension Pneumatic Seat Height Tilt Lock</p> <p>Multi-Task Adjustments 4-Position Tilt Tension Pneumatic Seat Height Tilt Lock Seat Depth</p> <p>Single Paddle Adjustments Preset Recline Tension Pneumatic Seat Height</p>	<p>3. Arm</p> <p>Arm</p> <p>00 ARMLESS</p> <p>01 HEIGHT ADJUSTABLE ARMS</p> <p>05 FIXED HEIGHT T-ARM</p> <p>07 FIXED HEIGHT D-ARM</p> <p> Armless  T-Arm  D-Arm</p> <p> Height Adjustable Arms</p> <p>Height adjustable arms come standard with 45° inward rotation and urethane caps.</p>	<p>4. Options</p> <p>Options</p> <p>01UC UPHOLSTERED ARM CAP FOR HEIGHT ADJUSTABLE ARM +72</p> <p>05UC UPHOLSTERED ARM CAP FOR T-ARM +72</p> <p>07UC UPHOLSTERED ARM CAP FOR D-ARM +173</p> <p>AC BLACK PLASTIC ARM CAP FOR D-ARM +32</p> <p>CT CONTRASTING THREAD</p> <p>Upholstered arm caps must be leather, vinyl, or polyurethane. Height adjustment lock-out comes standard on all Sava chairs.</p>	<p>5. Caster</p> <p>Caster</p> <p>BC BLACK HARD WHEEL</p> <p>BS BLACK SOFT WHEEL +42</p> <p>CC CHROME TRIM +98</p> <p>CS CHROME TRIM SOFT WHEEL +123</p> <p>GA GLIDES W/ABS PADS +98</p> <p>GF GLIDES W/FELT PADS +98</p>	<p>6. Arm Finish</p> <p>Arm Finish</p> <p>AL POLISHED ALUMINUM</p> <p>CH CHROME +473</p> <p>BM BLACK MATTE</p> <p>Chrome finish is only available on Fixed Height D-Arms (07)</p> <p>Black Matte finish is only available on the Single Paddle control. Black Matte finish on arms is only available on Fixed Height T-Arm (05) or D-Arm (07).</p>	<p>7. Upholstery</p> <p>See general information section for details on textile program and COM/ COL information.</p>
--	--	--	---	--	---	--

Sava

HIGH BACK: EURO UPHOLSTERY BACK, EURO UPHOLSTERY SEAT

TITLE	STYLE	CTRL	ARM	HEIGHT	DIMENSIONS	YDG	SQFT	Textile Upholstery Grades										Leather Upholstery Grades							
								COM	COL	COM	COL	A	B	C	D	E	F	G	H	I	J	K	L	M	W
High Back, Euro Upholstery Back, Euro Upholstery Seat, Conference Mechanism	Armless	SV58	2	00	19W x 26.5D x 37.5-42.5H	1.7	25	1924	2003	2084	2163	2246	2331	2418	2520	2621	2733	2904	3045	3181	2699	2804	3264	3510	3925
	Adjustable Arm	SV58	2	01	27.5W x 26.5D x 37.5-42.5H	1.7	25	2378	2460	2540	2619	2703	2787	2873	2976	3075	3190	3360	3501	3637	3155	3258	3749	3993	4407
	Fixed T-Arm	SV58	2	05	27.5W x 26.5D x 37.5-42.5H	1.7	25	2160	2241	2322	2399	2483	2567	2654	2755	2858	2972	3141	3282	3418	2936	3042	3514	3761	4176
	Fixed D-Arm	SV58	2	07	23.5W x 26.5D x 37.5-42.5H	1.7	25	2087	2171	2250	2330	2414	2498	2584	2687	2787	2901	3072	3213	3350	2867	2972	3443	3689	4100
High Back, Euro Upholstery Back, Euro Upholstery Seat, Multi-Task Mechanism	Armless	SV58	4	00	19W x 26.5D x 37.5-42.5H	1.7	25	2043	2127	2206	2284	2368	2454	2539	2641	2742	2855	3026	3167	3303	2820	2925	3396	3641	4053
	Adjustable Arm	SV58	4	01	27.5W x 26.5D x 37.5-42.5H	1.7	25	2498	2582	2661	2739	2822	2910	2994	3099	3198	3309	3482	3622	3759	3275	3382	3878	4123	4535
	Fixed T-Arm	SV58	4	05	27.5W x 26.5D x 37.5-42.5H	1.7	25	2280	2363	2442	2521	2605	2690	2776	2879	2978	3091	3262	3403	3539	3057	3161	3645	3892	4304
	Fixed D-Arm	SV58	4	07	23.5W x 26.5D x 37.5-42.5H	1.7	25	2209	2293	2373	2453	2536	2621	2705	2809	2910	3022	3194	3335	3471	2986	3093	3570	3817	4228
High Back, Euro Upholstery Back, Euro Upholstery Seat, Single Paddle Mechanism	Armless	SV58	1	00	19W x 26.5D x 37.5-42.5H	1.7	25	1642	1720	1803	1881	1966	2046	2135	2237	2337	2452	2621	2762	2898	2415	2521	2964	3210	3626
	Adjustable Arm	SV58	1	01	27.5W x 26.5D x 37.5-42.5H	1.7	25	2095	2178	2256	2335	2420	2503	2590	2691	2792	2907	3076	3217	3353	2872	2977	3446	3694	4108
	Fixed T-Arm	SV58	1	05	27.5W x 26.5D x 37.5-42.5H	1.7	25	1877	1956	2038	2116	2200	2284	2370	2472	2574	2687	2857	2998	3134	2653	2756	3215	3462	3875
	Fixed D-Arm	SV58	1	07	23.5W x 26.5D x 37.5-42.5H	1.7	25	1806	1887	1969	2045	2132	2216	2300	2405	2503	2618	2788	2929	3066	2584	2687	3144	3388	3801

To Order Select Below

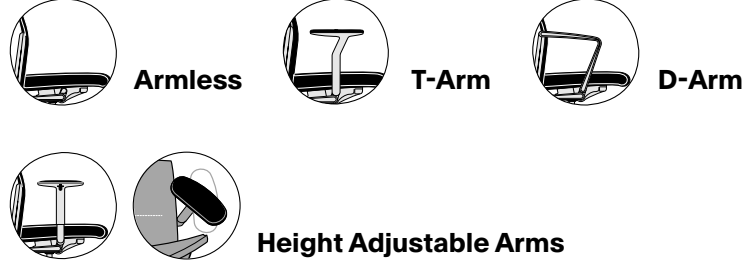



<p>1. Series/Back/Style</p> <p>SV58</p> <p>Sava Chair High Back, Euro Upholstery Back Euro Upholstery Seat</p> 	<p>2. Control</p> <p>Control</p> <p>2 CONFERENCE MECHANISM</p> <p>4 MULTI-TASK MECHANISM</p> <p>1 SINGLE PADDLE MECHANISM</p> <p>Conference Adjustments Preset Recline Tension Pneumatic Seat Height Tilt Lock</p> <p>Multi-Task Adjustments 4-Position Tilt Tension Pneumatic Seat Height Tilt Lock Seat Depth</p> <p>Single Paddle Adjustments Preset Recline Tension Pneumatic Seat Height</p>	<p>3. Arm</p> <p>Arm</p> <p>00 ARMLESS</p> <p>01 HEIGHT ADJUSTABLE ARMS</p> <p>05 FIXED HEIGHT T-ARM</p> <p>07 FIXED HEIGHT D-ARM</p>  <p>Height adjustable arms come standard with 45° inward rotation and urethane caps.</p>	<p>4. Options</p> <p>Options</p> <p>01UC UPHOLSTERED ARM CAP FOR HEIGHT ADJUSTABLE ARM +72</p> <p>05UC UPHOLSTERED ARM CAP FOR T-ARM +72</p> <p>07UC UPHOLSTERED ARM CAP FOR D-ARM +173</p> <p>AC BLACK PLASTIC ARM CAP FOR D-ARM +32</p> <p>CT CONTRASTING THREAD</p> <p>Upholstered arm caps must be leather, vinyl, or polyurethane. Height adjustment lock-out comes standard on all Sava chairs.</p>	<p>5. Caster</p> <p>Caster</p> <p>BC BLACK HARD WHEEL</p> <p>BS BLACK SOFT WHEEL +42</p> <p>CC CHROME TRIM +98</p> <p>CS CHROME TRIM SOFT WHEEL +123</p> <p>GA GLIDES W/ABS PADS +98</p> <p>GF GLIDES W/FELT PADS +98</p>	<p>6. Arm Finish</p> <p>Arm Finish</p> <p>AL POLISHED ALUMINUM</p> <p>CH CHROME +473</p> <p>BM BLACK MATTE</p> <p>Chrome finish is only available on Fixed Height D-Arms (07)</p> <p>Black Matte finish is only available on the Single Paddle control. Black Matte finish on arms is only available on Fixed Height T-Arm (05) or D-Arm (07).</p>	<p>7. Upholstery</p> <p>See general information section for details on textile program and COM/ COL information.</p>
---	--	--	---	--	---	---

Sava

HIGH BACK: THIN PAD BACK, THIN PAD SEAT

TITLE	STYLE	CTRL	ARM	HEIGHT	DIMENSIONS	YDG	SQFT	Textile Upholstery Grades				Leather Upholstery Grades													
								COM	COL	COM	COL	A	B	C	D	E	F	G	H	I	J	K	L	M	W
High Back, Thin Pad Back, Thin Pad Seat, Conference Mechanism	Armless	SV78	2	00	19W x 26.5D x 37.5-42.5H	2.2	40	2186	2305	2414	2523	2639	2754	2873	3018	3156	3311	3548	3743	3932	3335	3600	4194	4602	5338
	Adjustable Arm	SV78	2	01	27.5W x 26.5D x 37.5-42.5H	2.2	40	2674	2791	2901	3008	3123	3240	3360	3503	3640	3797	4033	4227	4416	3772	4039	4632	5040	5774
	Fixed T-Arm	SV78	2	05	27.5W x 26.5D x 37.5-42.5H	2.2	40	2441	2555	2667	2777	2891	3007	3125	3270	3407	3563	3800	3994	4182	3571	3837	4431	4837	5573
	Fixed D-Arm	SV78	2	07	23.5W x 26.5D x 37.5-42.5H	2.2	40	2367	2482	2592	2703	2818	2933	3051	3193	3332	3488	3724	3918	4106	3493	3761	4354	4763	5497
High Back, Thin Pad Back, Thin Pad Seat, Multi-Task Mechanism	Armless	SV78	4	00	19W x 26.5D x 37.5-42.5H	2.2	40	2318	2433	2543	2654	2767	2885	3004	3146	3283	3440	3676	3871	4059	3450	3717	4311	4718	5454
	Adjustable Arm	SV78	4	01	27.5W x 26.5D x 37.5-42.5H	2.2	40	2804	2918	3028	3142	3254	3371	3488	3631	3771	3926	4163	4357	4546	3888	4154	4749	5156	5892
	Fixed T-Arm	SV78	4	05	27.5W x 26.5D x 37.5-42.5H	2.2	40	2569	2685	2795	2906	3020	3138	3255	3400	3537	3692	3930	4125	4313	3688	3954	4548	4955	5689
	Fixed D-Arm	SV78	4	07	23.5W x 26.5D x 37.5-42.5H	2.2	40	2497	2611	2721	2833	2947	3064	3180	3322	3464	3618	3854	4049	4237	3610	3879	4473	4877	5613
High Back, Thin Pad Back, Thin Pad Seat, Single Paddle Mechanism	Armless	SV78	1	00	19W x 26.5D x 37.5-42.5H	2.2	40	1886	2000	2112	2223	2336	2454	2569	2715	2854	3008	3245	3440	3628	3051	3317	3912	4318	5055
	Adjustable Arm	SV78	1	01	27.5W x 26.5D x 37.5-42.5H	2.2	40	2372	2490	2597	2706	2821	2938	3057	3203	3340	3493	3731	3926	4114	3489	3756	4349	4758	5490
	Fixed T-Arm	SV78	1	05	27.5W x 26.5D x 37.5-42.5H	2.2	40	2138	2253	2366	2473	2590	2705	2822	2965	3105	3262	3497	3692	3880	3288	3554	4149	4554	5290
	Fixed D-Arm	SV78	1	07	23.5W x 26.5D x 37.5-42.5H	2.2	40	2065	2180	2291	2399	2517	2631	2749	2892	3029	3186	3422	3616	3804	3210	3478	4073	4595	5213

To Order Select Below

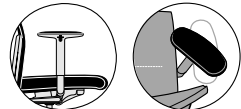
<p>1. Series/Back/Style</p> <p>SV78</p> <p>Sava Chair High Back, Thin Pad Back, Thin Pad Seat</p> 	<p>2. Control</p> <p>Control</p> <p>2 CONFERENCE MECHANISM</p> <p>4 MULTI-TASK MECHANISM</p> <p>1 SINGLE PADDLE MECHANISM</p> <p>Conference Adjustments Preset Recline Tension Pneumatic Seat Height Tilt Lock</p> <p>Multi-Task Adjustments 4-Position Tilt Tension Pneumatic Seat Height Tilt Lock Seat Depth</p> <p>Single Paddle Adjustments Preset Recline Tension Pneumatic Seat Height</p>	<p>3. Arm</p> <p>Arm</p> <p>00 ARMLESS</p> <p>01 HEIGHT ADJUSTABLE ARMS</p> <p>05 FIXED HEIGHT T-ARM</p> <p>07 FIXED HEIGHT D-ARM</p> <p> Armless  T-Arm  D-Arm</p> <p> Height Adjustable Arms</p> <p>Height adjustable arms come standard with 45° inward rotation and urethane caps.</p>	<p>4. Options</p> <p>Options</p> <p>01UC UPHOLSTERED ARM CAP FOR HEIGHT ADJUSTABLE ARM +72</p> <p>05UC UPHOLSTERED ARM CAP FOR T-ARM +72</p> <p>07UC UPHOLSTERED ARM CAP FOR D-ARM +173</p> <p>AC BLACK PLASTIC ARM CAP FOR D-ARM +32</p> <p>CT CONTRASTING THREAD</p> <p>Upholstered arm caps must be leather, vinyl, or polyurethane. Height adjustment lock-out comes standard on all Sava chairs.</p>	<p>5. Caster</p> <p>Caster</p> <p>BC BLACK HARD WHEEL</p> <p>BS BLACK SOFT WHEEL +42</p> <p>CC CHROME TRIM +98</p> <p>CS CHROME TRIM SOFT WHEEL +123</p> <p>GA GLIDES W/ABS PADS +98</p> <p>GF GLIDES W/FELT PADS +98</p>	<p>6. Arm Finish</p> <p>Arm Finish</p> <p>AL POLISHED ALUMINUM</p> <p>CH CHROME +473</p> <p>BM BLACK MATTE</p> <p>Chrome finish is only available on Fixed Height D-Arms (07)</p> <p>Black Matte finish is only available on the Single Paddle control. Black Matte finish on arms is only available on Fixed Height T-Arm (05) or D-Arm (07).</p>	<p>7. Upholstery</p> <p>See general information section for details on textile program and COM/ COL information.</p>
--	--	--	---	--	---	--

stylex

Share

PRICE LIST

Effective November 01, 2023

General Information

GENERAL INFORMATION

Terms

Net 30 days from date of invoice,
F. O. B . Delanco, New Jersey.

Damaged Shipments

All Stylex products are carefully inspected before they are packed in sturdy cartons designed to satisfy shipping requirements. Stylex is not responsible for damage in shipment. The transportation company assumes responsibility for delivering products to you in good condition when the bill of lading is signed. You protect yourself by refusing shipments showing damage or shortage until transportation company has noted on the delivery sheet the extent of damage or shortage. Concealed damage should be reported to the carrier as soon as discovered, but not later than 15 days after receiving shipment.

Return/Restocking Policy

Return shipments will not be accepted unless specifically authorized by Stylex in writing. The Return Authorization number should be clearly marked on the carton. The customer returning Stylex products is responsible for return shipping costs. Merchandise must be returned unused. Returned merchandise is subject to a 35% restocking fee.

Custom Products

Modifications to standard products will be considered for large runs. Contact factory for price quotations.

Design Changes

In keeping with modern manufacturing advances, Stylex reserves the right to incorporate minor modifications and design changes in products without notice.

Cancellation Policy

No charge prior to production except for inventory specifically requisitioned to fulfill the particular order. After production has begun, only actual costs incurred, including labor and material, will be billed to the customer.

WARRANTY

Except as provided below, Stylex warrants exclusively to the original Purchaser of our product that all parts, under normal use and service, will be free from defects in workmanship and material for a period of ten (10) years from the date of purchase. "Normal use and service" means that the product will be used in a typical office environment for 40-45 hours per week.

This warranty is subject to the following limitations, exclusions and provisions:

Limitations involving materials and components:

Wood components of plywood stacking chairs
(such as Brooks and Welcome)
5 years

Upholstery

(including mesh used for Click, F4, Insight, and Zephyr Mesh)
3 years

SAVA Mesh

10 years

COM Upholstery

No warranty
Stylex makes every effort to ensure that the COM Upholstery it approves is suitable for the intended use. Nevertheless, we will not warrant, and assume no responsibility for, the durability or tailoring quality of any COM or COL . If you have any concerns about the ultimate appearance of any covering, please order an upholstered sample.

Painted Stack Chair Frames

No Warranty

We will not warrant the finish of painted stack chair frames against damage from stacking. Please order chrome frames for chairs that will be stacked.

Felt Glides

No warranty

Due to the different surfaces on which felt glides may be used, we cannot warrant their durability over time.

If this product fails during normal use and service within the applicable warranty period (other than through normal wear and tear), please send a description of the relevant part and the nature of the defect, together with proof of purchase of the product, to Stylex at: Customer Service. c/o Stylex, P.O. Box 5038, Delanco, NJ 08075. PLEASE DO NOT RETURN PARTS OR THE PRODUCT TO STYLEX UNLESS INSTRUCTED TO DO SO BY STYLEX. Stylex will, at its option, either repair or replace the product or the part found defective by Stylex completely without charge for materials or labor. Purchaser may be required (at the option of Stylex) to return to Stylex at Purchaser's expense any defective part with all freight or shipping charges prepaid. The foregoing warranty shall be void if the product has been altered or repaired (other than by Stylex). The warranty does not cover damage to the product caused by accident, neglect, misuse, abuse, modification to the product by anyone other than Stylex or damage caused by use of the product for a purpose other than that for which it was designed. This warranty extends only to the original Purchaser of the product.

No Other Warranties

This warranty is in lieu of all other warranties, expressed or implied, including, but not limited to, implied warranties of merchantability and fitness for a particular purpose. The rights and remedies provided herein are the exclusive rights and remedies of the original purchaser of the product.

No Liability For Damages

In no event shall Stylex or its suppliers be responsible or liable for any special, indirect, consequential, or incidental damages. In no event shall the liability of Stylex exceed the actual purchase price paid to Stylex for the product.

Out of Warranty Products

For all products no longer covered by our warranty, please refer to our Design for Durability and Upgradability Policy. Contact Customer Service if you would like to purchase any replaceable components to further extend the life of any Stylex seating product. This warranty applies to all Stylex products purchased on April 13, 2018, and thereafter.

PRODUCT TAKE BACK PROGRAM

In order to be good stewards of our products, Stylex offers a pathway towards a Product Take Back Program as a more viable solution to the end of our products' originally intended life.

Stylex supports the sustainable programs of ANEW and offers their added value to our clients through a comprehensive take-back solution for surplus office furniture and materials of any kind, in any condition. ANEW is a 501(c)(3) non-profit organization that exists to provide companies with smart, cost effective alternatives for their surplus furniture and other items with the priority of matching it to non- profits, public agencies and the underserved, within the local community of the project site. Corporate Social Responsibility is raised while the impact on the environment is lowered by diverting products and materials otherwise destined for landfill.

Stylex is proud to offer ANEW to customers dedicated to strengthening their community network by repurposing their furniture, fixtures and architectural materials to those in need. In 2014, Stylex committed to making this relationship a part of our strategic sales strategy. Visit www.anewfound.org to find out more.

To initiate a Product Take Back strategy through ANEW, contact Stylex Customer Service at 800-257-5742.

For other end of life recovery options, please see our Product Disassembly Instructions and End of Life Recovery Options documents available on our website in the resources section of each product in our line.

FREIGHT PROGRAM

Stylex offers a Guaranteed Freight Program, which provides the purchaser the ability to determine shipping and handling charges at the time of order. Freight charges will be calculated as a percentage of the net product price and added to the invoice at the time of shipment. The continental United States has been divided into three zones. Please use the map below to determine the freight charges for the product's destination. There is a minimum freight charge of \$150.

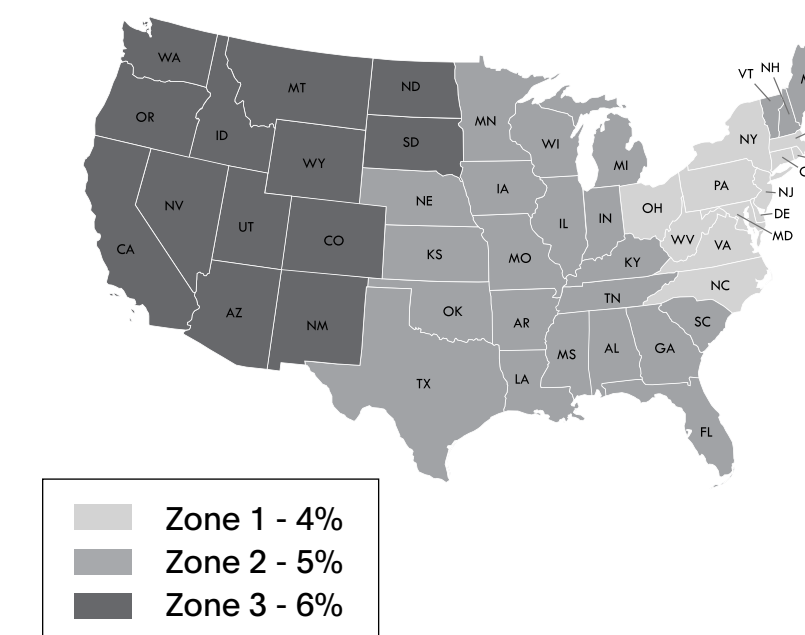

ZONE 1 - 4%

Connecticut
Delaware
New York
New Jersey
Maryland
Massachusetts
North Carolina
Ohio
Pennsylvania
Rhode Island
Virginia
Washington D.C.
West Virginia

ZONE 2 - 5%

Alabama
Arkansas
Canada, Ontario
Canada, Quebec
Florida
Georgia
Iowa
Illinois
Indiana
Kansas
Kentucky
Louisiana
Nebraska
New Hampshire
Oklahoma
Maine
Michigan
Minnesota
Missouri
Mississippi
South Carolina
Tennessee
Texas
Vermont
Wisconsin

ZONE 3 - 6%

Arizona
California
Colorado
Idaho
Montana
Nevada
New Mexico
North Dakota
Oregon
South Dakota
Utah
Washington
Wyoming

Quote Per Project
Alaska
Hawaii
Canada
(outside Ontario & Quebec)
Mexico

General Information

TEXTILE PARTNERS & APPROVALS

Textile Partners

To customize your furniture performance needs and design vision, Stylex offers a wide selection of in-graded leathers and textiles from Grades A through Y. We've partnered with leading manufacturers on the options, focusing on color, price, durability, and construction. To view our partners and explore our digital carded program with broadly approved textiles, visit [this page](#). We stand by these textiles: They're tried and tested, and will effortlessly fit into any design aesthetic.

Textile Approvals

To view Stylex Approved Textile documents to determine specific product approval status, visit [this page](#).

CAL 117 AND 133 COMPLIANCE

CAL 117-2013

All Stylex seating satisfies the requirements of CAL 117-2013 so long as one of our standard or in-graded fabrics is applied. COM textiles cannot be so guaranteed. Please contact the supplier of COM's directly to determine the fire retardancy of any COM supplied to us.

CAL 133

Most Stylex seating can be ordered to meet the requirements of CAL 133. When ordering, simply specify "CAL 133 compliance required". The upcharge for this option is \$54 list per yard. Please refer to the COM yardage of each model to determine the number of yards required. We do frequently require full-scale burn tests in order to certify CAL 133 before an order will be accepted. Such burn tests may increase normal lead times and do carry additional charges. Please contact customer service for details.

CUSTOMER'S OWN MATERIAL/LEATHER

Customer's own material (COM) and customer's own leather (COL) will generally be upholstered at the price designated in each product's price list. Please be advised, however, that we specifically reserve the right to charge a higher price when we determine that special circumstances, such as unusual repeats or challenging materials, present themselves. All orders for custom coverings must be approved by Stylex before they will be accepted for production. To submit proposed textile for approval, please use the COM form [here](#).

Special Note:

We assume no responsibility for the durability or tailoring quality of any COM or COL. Directional covers in particular may not meet your satisfaction due to the design of certain products. Please be advised that COM and COL orders are not subject to return. If you have doubts about the ultimate appearance of certain coverings, please order a sample done with that specific COM or COL. In addition, while we inspect fabrics for mill imperfections, some are difficult to recognize. We cannot be responsible for defects, color inaccuracies, dye lot variations, or other flaws.

Under no circumstances will we be responsible for COM shortages, flaws, or other such problems. Finally, it is not our responsibility to police the receipt of COM's in order to meet delivery deadlines, and we assume our customers are aware of any undue delay in the shipment of their COM fabrics.

COM fabric and COL leather should be sent prepaid to: Stylex

**Attn: COM/COL - [Your PO #]
740 Coopertown Road
Delanco, NJ 08075**

Clearly mark fabric or leather with the dealers name, purchase order number, and furniture model number of the item to be covered. Actual furniture orders should include the same information, as well as a description of the fabric or leather, including pattern and color number, in order to provide a cross reference.

Yardage requirements shown in the price list are based on non-directional goods of 54" width. Fabrics less than 54" wide or those requiring matching (stripes, prints, or large patterned designs) call for additional yardage. We will be happy to supply yardage requirements for large quantities where economies may be realized.

Add the following yardage for stripes, plaids, or patterns with repeats:

Fabric Width	Plain Fabric	2-14" Repeat	15-24" Repeat	25-27" Repeat	28-36" Repeat
54"	0%	10%	15%	20%	25%
50"	10%	20%	25%	30%	35%
48"	15%	25%	30%	35%	40%
45"	40%	50%	55%	60%	65%
36"	50%	60%	65%	70%	75%

COM/COL FORM

To avoid delay in processing COM orders we request that you submit a sample of your COM fabric stapled to this form which can be downloaded [here](#). If a fabric has a stripe or design, the size of the repeat should be indicated. Please indicate the fabric supplier's name, fabric number, and color. Also indicate the Stylex product on which the fabric will be used.

The fabric supplier must indicate on his shipping labels the dealer name and purchase order number as well as the Stylex model number.

Please Note:

No order may be entered into production or have a shipping date assigned until all related COM is received at the factory.



CENTER OF STRIPE OR DESIGN

TOP OF CHAIR	TOP OF CHAIR
--------------	--------------

1. Size of Repeat

2. Fabric Supplier

3. Fabric Number

4. Color

5. Stylex Product

Share

Contents

<hr/>		<hr/>		<hr/>	
COLORS, MATERIALS, AND FINISHES	5	CHAIR	11	END CAP: SINGLE NARROW	46
STATEMENT OF LINE	6	CHAIR: CORNER	20	KNEE WALL	51
OPTIONS AND ACCESSORIES	7	CHAIR: CURVED	26	ARM	53
DIMENSIONS	8	BENCH	38	ROUND OTTOMAN	54
IDEA STARTERS	9	BENCH: CORNER	41	ACCESSORIES	55
HOW TO ORDER	10	BENCH: CURVED	42		
<hr/>		<hr/>		<hr/>	

CLICK THE TITLES ABOVE TO NAVIGATE THROUGH THE DOCUMENT
PRODUCT HEADERS ON SUBSEQUENT PAGES LINK BACK TO THIS PAGE

Share

COLORS, MATERIALS, AND FINISHES

POWDER PAINT LEG FINISHES

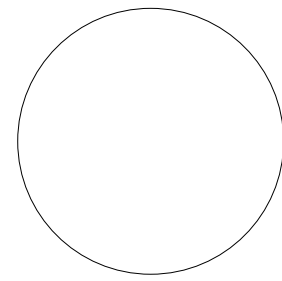

MILK
(MK)

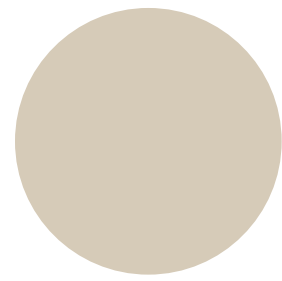

SAND
(SD)

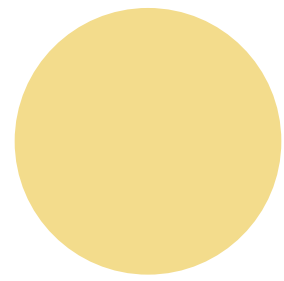

PALE YELLOW
(PY)

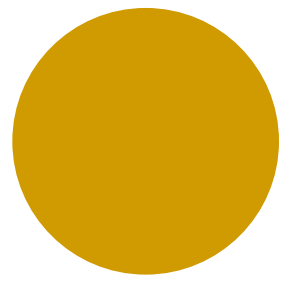

YELLOW
(YL)

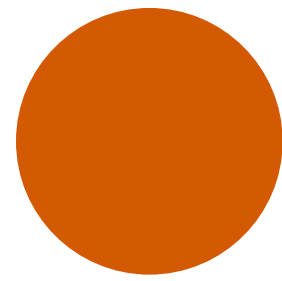

ORANGE
(OR)

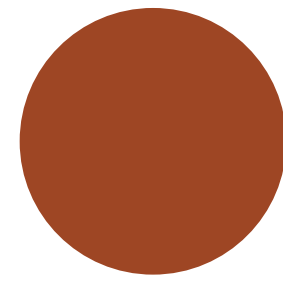

TERRACOTTA
(TC)

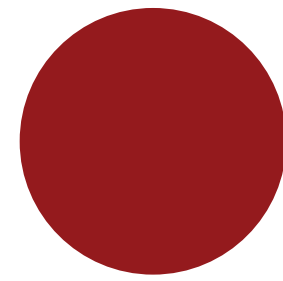

RED
(RD)

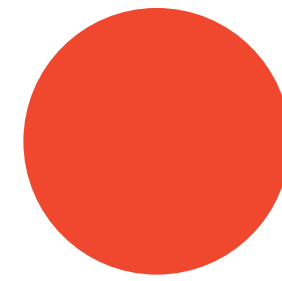

RED ORANGE
(RO)

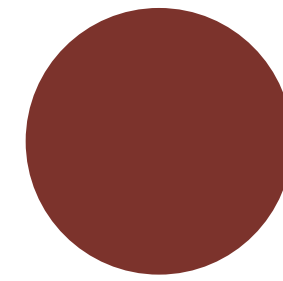

RUSTY RED
(RR)

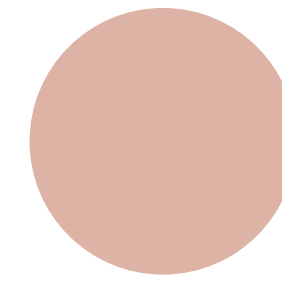

DUSTY PINK
(DP)

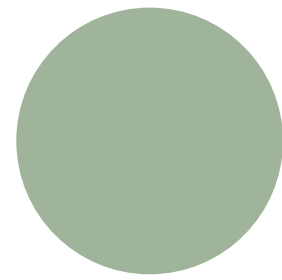

MEADOW GREEN
(MG)

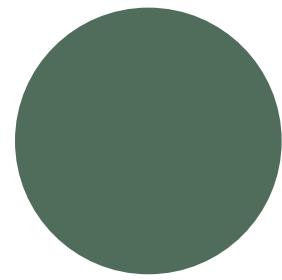

FOREST GREEN
(FG)

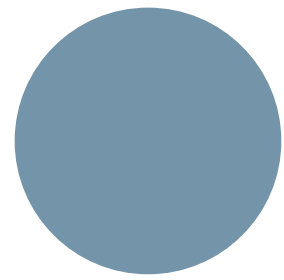

SOFT BLUE
(SB)

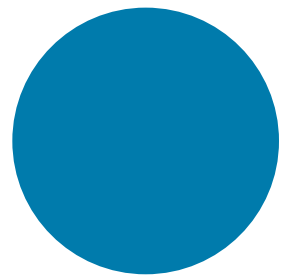

BLUE
(BL)

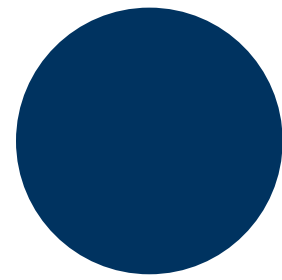

NAVY
(NV)

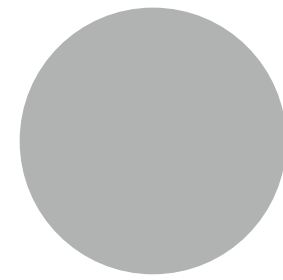

LIGHT GRAY
(LG)



CHAMPAGNE
(CP)

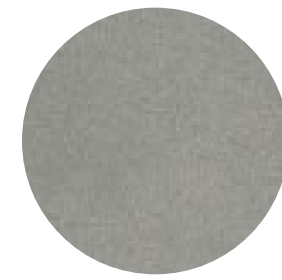

METALLIC SILVER
(MS)

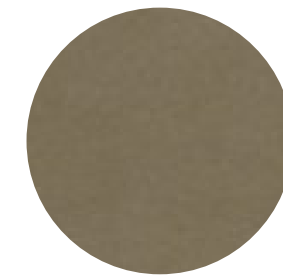

NICKEL
(NK)

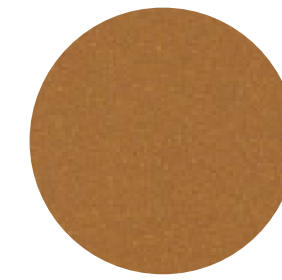

BRASS
(BR)

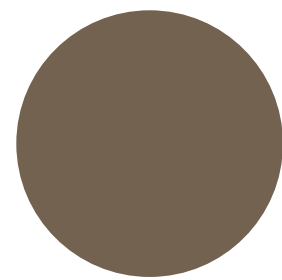

TAUPE
(TP)



DARK BRONZE
(DB)

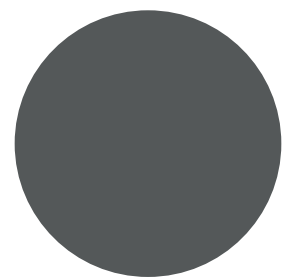

DARK GRAY
(DG)



TEXTURED SLATE
(TS)

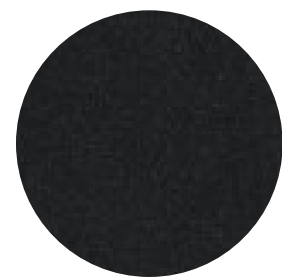

BLACK TWILIGHT
(BT)

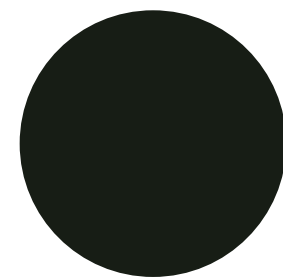

BLACK MATTE
(BM)

POLISHED METAL LEG FINISH

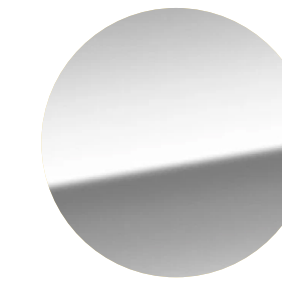

POLISHED
ALUMINUM
(AL)

WOOD LEG FINISH



NATURAL MAPLE
(83)



WHITE OAK
(81)



WALNUT
(85)

Share

SPECIFICATION GUIDE: STATEMENT OF LINE

OVERVIEW						
Chairs Lounge Height Task Height	Single-Seater	Two-Seater	Three-Seater	120° Corner	90° Corner	
Banquette Chairs Task Height	Single-Seater	Two-Seater	Three-Seater	120° Corner	90° Corner	
Benches Lounge Height Task Height	Single-Seater	Two-Seater	Three-Seater	120° Corner	90° Corner	
End Cap Lounge Height Task Height	Single Narrow	Double Narrow	Double Narrow +	Double Wide	Double Wide +	
Knee Walls - 9"W Low Knee Wall / Armrest Height High Knee Wall / Seat Back Height	Low/Low+	High/High+	Arms - 4"W Armrest Height	24"H*	26"H*	* Armrest surface is 24" above the floor ** Armrest surface is 26" above the floor
Curved Chairs Lounge Height Task Height	30° Outside	30° Inside	60° Outside	60° Inside	90° Outside	90° Inside
Curved Benches Lounge Height Task Height	30° Inside	60° Inside	90° Inside	Round Ottomam Lounge Height Task Height		

GENERAL INFORMATION

Design
Stylex

Ganging

All individual units may be connected to one another with the use of a simple draw latch system.

Legs

Share is available with 3 leg options: corner, round, and wood. Angle and round legs are cast aluminum and may be polished or painted. The wood legs come in three standard finishes and are also available in custom finishes. Adjustable glides are standard.

Power In Knee Walls

Power receptacle offers onetouch accessibility to two different power ports: a usb 2.1A port and a standard, grounded 3-prong electrical outlet.

Power In Chairs And Benches

Power receptacle offers three exposed power ports: 2 usb 2.1A ports and a standard, grounded 3-prong electrical outlet.

Testing

Manufactured to comply with:

- ANSI/BIFMA X5.4 Public and Lounge Seating Standard

Environment

Greenguard certified.

Share

SPECIFICATION GUIDE: OPTIONS AND ACCESSORIES

OVERVIEW

Chairs

Power Port Options

Right Side

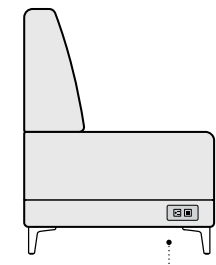

C14/C24

Front

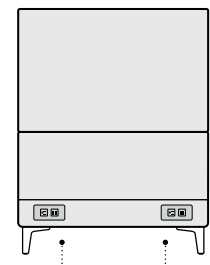

C13/C23

C12/C22

Left Side

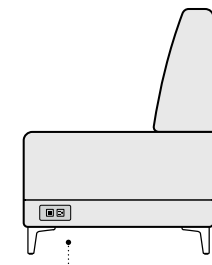

C11/C21

Back

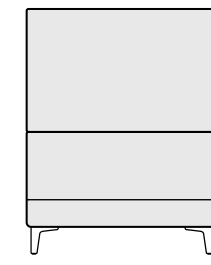

No Power Ports

Power Port Details

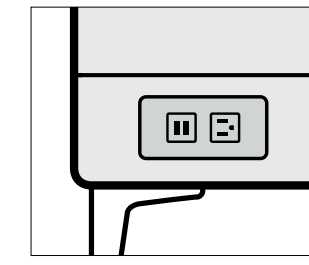

Power Plate

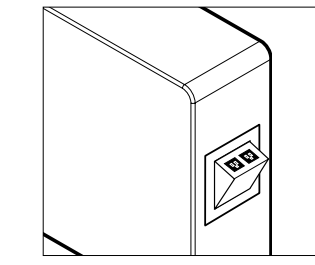

Knee Wall Flip Out Power

Benches

Power Port Options

Right Side

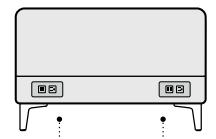

C15/C25

C14/C24

Front

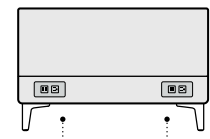

C13/C23

C12/C22

Left Side

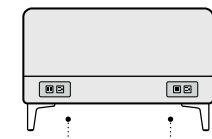

C11/C21

C18/C28

Back

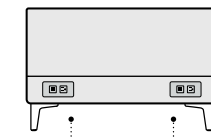

C17/C27

C16/C26

Accessories

Privacy Screen

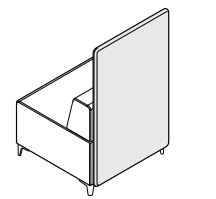

Cube Seats

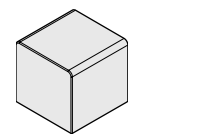

Leg Options

Corner Leg

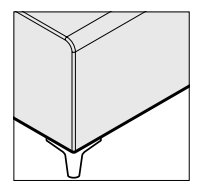

Round Leg

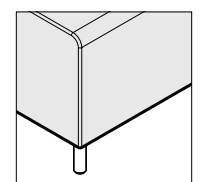

Wood Leg

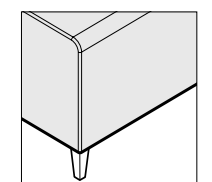

Ganging

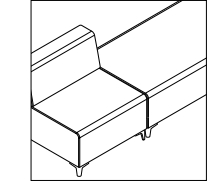

Cover Options

Standard

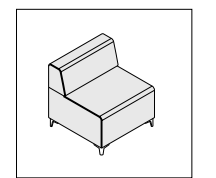

Waterline Mono-Color

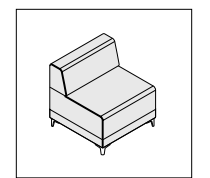

Waterline Dual-Color

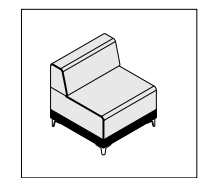

Seat & Back No Waterline

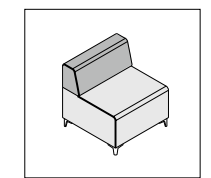

Seat & Back With Waterline

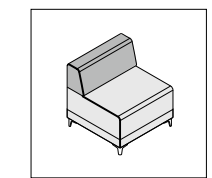

Tri-Color Upholstery Seat, Back & Waterline

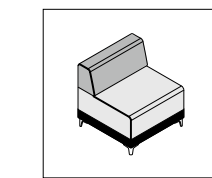

GENERAL INFORMATION

In-Seat Power Ports With 10' Or 20' Cord

Power Port Cord Length

C1× has a 10' power cord. C2× has a 20' power cord

Power Port Location

The power port location is determined by its last digit.

Examples:

- A C14 power port has a 10' power cord and is located on the right side of a chair or the right forward position of a bench.
- A C21 power port has a 20' power cord and is located on the left side of a chair or the left forward position of a bench.

Note:

Curved units may only have power ports located on the sides, not on the front or back. Power ports are not available on ottomans. Multiple power ports may be ordered per unit. The pricing shown is for each power port ordered.

In-Seat Power Port Finish

Power ports can be finished in any standard powder coat available.

Power In Chairs And Benches

Power receptacle offers three exposed power ports: 2 USB 2.1A ports and a standard, grounded 3-prong electrical outlet.

Power In Knee Walls

Power receptacle offers one-touch accessibility to two different power ports: a USB 2.1A port and a standard, grounded 3-prong electrical outlet.

Ganging

All individual units may be connected to one another with the use of a simple draw latch system.

Legs

Share is available with 3 leg options: angle, round, and wood. Angle and round legs are cast aluminum and may be polished or painted. The wood legs come in three standard finishes and are also available in custom finishes. Adjustable glides are standard.

Share

SPECIFICATION GUIDE: DIMENSIONS

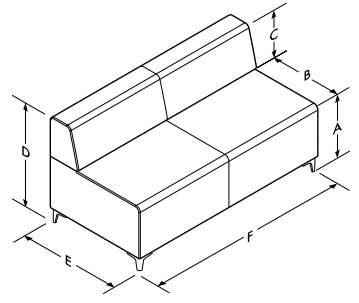
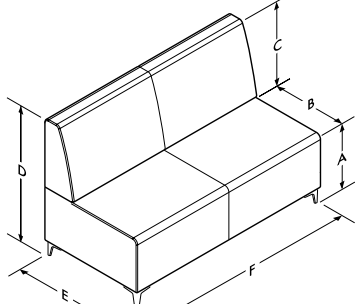
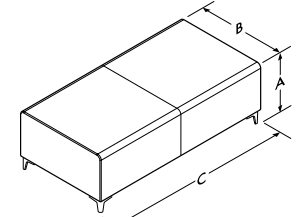
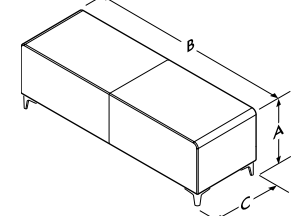
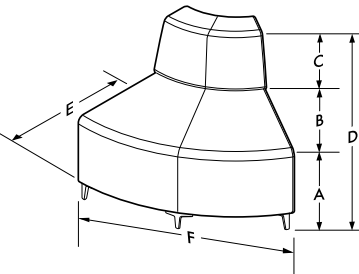
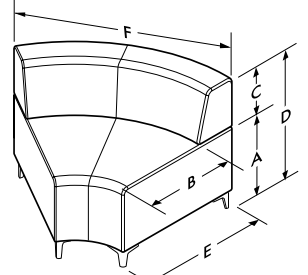
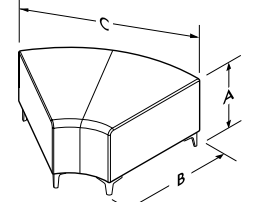
OVERVIEW	TASK HEIGHT			LOUNGE HEIGHT		
Chairs A. Seat Height B. Seat Depth C. Back Height D. Overall Height E. Overall Depth F. Overall Width 	Single-Seater A. 18" B. 19" C. 11" D. 29" E. 28" F. 28"	Two-Seater A. 18" B. 19" C. 11" D. 29" E. 28" F. 56"	Three-Seater A. 18" B. 19" C. 11" D. 29" E. 28" F. 84"	Single-Seater A. 16" B. 19" C. 13" D. 29" E. 28" F. 28"	Two-Seater A. 16" B. 19" C. 13" D. 29" E. 28" F. 56"	Three-Seater A. 16" B. 19" C. 13" D. 29" E. 28" F. 84"
Banquette Chairs A. Seat Height B. Seat Depth C. Back Height D. Overall Height E. Overall Depth F. Overall Width 	Single-Seater A. 18" B. 19" C. 18" D. 36" E. 28" F. 28"	Two-Seater A. 18" B. 19" C. 18" D. 36" E. 28" F. 56"	Three-Seater A. 18" B. 19" C. 18" D. 36" E. 28" F. 84"	-	-	-
Benches A. Overall/Seat Height B. Seat Depth C. Overall Width 	Single-Seater A. 18" B. 28" C. 28"	Two-Seater A. 18" B. 28" C. 56"	Three-Seater A. 18" B. 28" C. 84"	Single-Seater A. 16" B. 28" C. 28"	Two-Seater A. 16" B. 28" C. 56"	Three-Seater A. 16" B. 28" C. 84"
End Caps - Narrow A. Height B. Depth C. Width 	Single A. 18" B. 28" C. 19"	Double A. 18" B. 56" C. 19"	Double + A. 18" B. 57" C. 19"	Single A. 16" B. 28" C. 19"	Double A. 16" B. 56" C. 19"	Double + A. 16" B. 57" C. 19"
Curved Outside Chairs A. Seat Height B. Seat Depth C. Back Height D. Overall Height E. Overall Depth F. Overall Width 	30° A. 18" B. 19" C. 11" D. 29" E. 28" F. 35"	60° A. 18" B. 19" C. 11" D. 29" E. 28" F. 38.875"	90° A. 18" B. 19" C. 11" D. 29" E. 28" F. 56.25"	30° A. 16" B. 19" C. 13" D. 29" E. 28" F. 35"	60° A. 16" B. 19" C. 13" D. 29" E. 28" F. 38.875"	90° A. 16" B. 19" C. 13" D. 29" E. 28" F. 56.25"
Curved Inside Chairs A. Seat Height B. Seat Depth C. Back Height D. Overall Height E. Overall Depth F. Overall Width 	30° A. 18" B. 19" C. 11" D. 29" E. 28" F. 35"	60° A. 18" B. 19" C. 11" D. 29" E. 28" F. 39.75"	90° A. 18" B. 19" C. 11" D. 29" E. 28" F. 56.25"	30° A. 16" B. 19" C. 13" D. 29" E. 28" F. 35"	60° A. 16" B. 19" C. 13" D. 29" E. 28" F. 39.75"	90° A. 16" B. 19" C. 13" D. 29" E. 28" F. 56.25"
Curved Benches A. Height B. Depth C. Width 	30° A. 18" B. 28" C. 35"	60° A. 18" B. 28" C. 39.75"	90° A. 18" B. 28" C. 56.25"	30° A. 16" B. 28" C. 35"	60° A. 16" B. 28" C. 39.75"	90° A. 16" B. 28" C. 56.25"

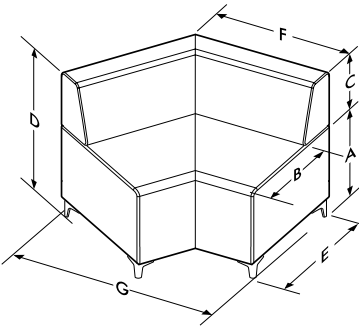
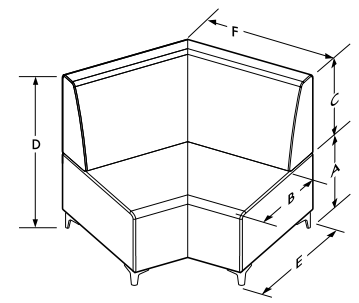
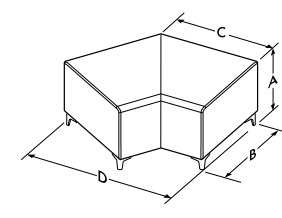
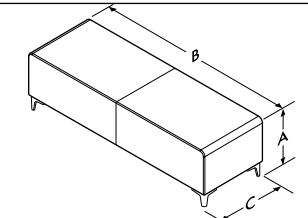
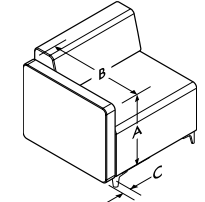
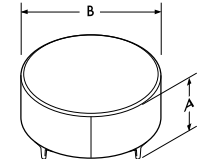
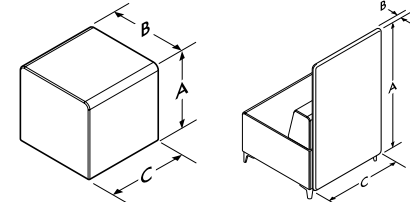
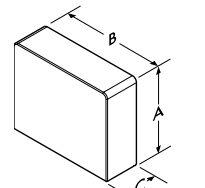
OVERVIEW	TASK HEIGHT		LOUNGE HEIGHT		
Corners A. Seat Height B. Seat Depth To Back C. Back Height D. Overall Height E. Overall Seat Depth F. Back Width G. Overall Width 	120° A. 18" B. 19" C. 11" D. 29" E. 28" F. 28" G. 42.5"	90° A. 18" B. 19" C. 11" D. 29" E. 28" F. 56" G. 42.5"	120° A. 16" B. 19" C. 13" D. 29" E. 28" F. 28" G. 42.5"	90° A. 16" B. 19" C. 13" D. 29" E. 28" F. 56" G. 42.5"	
Banquette Corners A. Seat Height B. Seat Depth To Back C. Back Height D. Overall Height E. Overall Seat Depth F. Back Width G. Overall Width 	120° A. 18" B. 19" C. 18" D. 36" E. 28" F. 28" G. 42.5"	90° A. 18" B. 19" C. 18" D. 36" E. 28" F. 56" G. 42.5"	-	-	
Corner Benches A. Overall/Seat Height B. Seat Depth C. Seat Width D. Overall Width 	120° A. 18" B. 28" C. 28" D. 42.5"	90° A. 18" B. 28" C. 56" D. 42.5"	120° A. 16" B. 28" C. 28" D. 42.5"	90° A. 16" B. 28" C. 56" D. 42.5"	
End Caps - Wide A. Height B. Depth C. Width 	Double A. 16" B. 56" C. 28"	Double + A. 16" B. 57" C. 28"	Double A. 16" B. 56" C. 28"	Double + A. 16" B. 57" C. 28"	
Arms A. Height B. Depth C. Width 	26" A. 22" B. 28" C. 4"	-	24" A. 20" B. 28" C. 4"	-	
Round Ottoman A. Overall/Seat Height B. Overall Depth 	A. 18" B. 36"	-	A. 16" B. 36"	-	
Accessories A. Height B. Depth C. Width 	Cube Seat A. 18" B. 19" C. 19"	Privacy Screen A. 43" B. 1.25" C. 27"	Cube Seat A. 16" B. 19" C. 19"	-	
Knee Wells A. Height B. Depth C. Width 	Low A. 24" B. 28" C. 9"	Low A. 24" B. 28.5" C. 9"	High A. 29" B. 28" C. 9"	High A. 29" B. 28.5" C. 9"	-

Share

SPECIFICATION GUIDE: IDEA STARTERS

IDEA STARTERS

Idea Starter 1



Idea Starter 2



Idea Starter 3



Idea Starter 4



Idea Starter 5



Idea Starter 6



SPECIFICATION TOOLS

Idea Starters Online and in CET

At Stylex, we have a constant eye towards making our products easy to specify. Our Design Application team is working on layouts every day, so we have built an online library of the most requested layouts, with all the accompanying information, files, and pricing. We believe these will make our products easier to specify, and in turn help kick start your project. You can also find these in CET; please check out our 'Idea Starters' tab on for the easiest way to drag-and-drop right into your layout. Visit [Stylexdesign.com/idea-starters](https://stylexdesign.com/idea-starters) to get started.

Share

SPECIFICATION GUIDE: HOW TO ORDER

MODEL CODE BREAKDOWN - SEATING

Sample Model Code: SH1116L381C11YL1COM



SH

1116

L381

C11YL

U1

COM

Series

SH SHARE

Series/Type/Seat

1116	SINGLE SEATER CHAIR - LOUNGE HEIGHT
1118	SINGLE SEATER CHAIR - TASK HEIGHT
7118	SINGLE SEATER BANQUETTE - TASK HEIGHT
1126	TWO-SEATER CHAIR - LOUNGE HEIGHT
1128	TWO-SEATER CHAIR - TASK HEIGHT
7128	TWO-SEATER BANQUETTE - TASK HEIGHT
1136	THREE-SEATER CHAIR - LOUNGE HEIGHT
1138	THREE-SEATER CHAIR - TASK HEIGHT
7138	THREE-SEATER BANQUETTE - TASK HEIGHT
1226	90DEG CHAIR - LOUNGE HEIGHT
1228	90DEG CHAIR - TASK HEIGHT
7228	90DEG BANQUETTE - TASK HEIGHT
1246	120DEG CHAIR - LOUNGE HEIGHT
1248	120DEG CHAIR - TASK HEIGHT
7248	120DEG BANQUETTE - TASK HEIGHT
1556	OUT 30DEG CURVED CHAIR - LOUNGE HEIGHT
1558	OUT 30DEG CURVED CHAIR - TASK HEIGHT
1566	OUT 60DEG CURVED CHAIR - LOUNGE HEIGHT
1568	OUT 60DEG CURVED CHAIR - TASK HEIGHT
1576	OUT 90DEG CURVED CHAIR - LOUNGE HEIGHT
1578	OUT 90DEG CURVED CHAIR - TASK HEIGHT
1456	IN 30DEG CURVED CHAIR - LOUNGE HEIGHT
1458	IN 30DEG CURVED CHAIR - TASK HEIGHT
1466	IN 60DEG CURVED CHAIR - LOUNGE HEIGHT
1468	IN 60DEG CURVED CHAIR - TASK HEIGHT
1476	IN 90DEG CURVED CHAIR - LOUNGE HEIGHT
1478	IN 90DEG CURVED CHAIR - TASK HEIGHT
0116	SINGE SEATER BENCH - LOUNGE HEIGHT
0118	SINGLE SEATER BENCH - TASK HEIGHT
0126	TWO SEATER BENCH - LOUNGE HEIGHT
0128	TWO SEATER BENCH - TASK HEIGHT
0136	THREE SEATER BENCH - LOUNGE HEIGHT
0138	THREE SEATER BENCH - TASK HEIGHT

0226	90DEG BENCH - LOUNGE HEIGHT
0228	90DEG BENCH - TASK HEIGHT
0246	120DEG BENCH - LOUNGE HEIGHT
0248	120DEG BENCH - TASK HEIGHT
0456	30DEG CURVED BENCH - LOUNGE HEIGHT
0458	30DEG CURVED BENCH - TASK HEIGHT
0466	60DEG CURVED BENCH - LOUNGE HEIGHT
0468	60DEG CURVED BENCH - TASK HEIGHT
0476	90DEG CURVED BENCH - LOUNGE HEIGHT
0478	90DEG CURVED BENCH - TASK HEIGHT
0486	ROUND OTTOMAN LOUNGE
0488	ROUND OTTOMAN TASK
0306	SINGLE NARROW END CAP - LOUNGE HEIGHT
0308	SINGLE NARROW END CAP - TASK HEIGHT
0316	DOUBLE NARROW END CAP - LOUNGE HEIGHT
0318	DOUBLE NARROW END CAP - TASK HEIGHT
0326	DOUBLE NARROW END CAP+ - LOUNGE HEIGHT
0328	DOUBLE NARROW END CAP+ - TASK HEIGHT
0346	DOUBLE WIDE END CAP - LOUNGE HEIGHT
0348	DOUBLE WIDE END CAP - TASK HEIGHT
0356	DOUBLE WIDE END CAP+ - LOUNGE HEIGHT
0358	DOUBLE WIDE END CAP+ - TASK HEIGHT
241	24H LOW KNEE WALL
242	24H LOW KNEE WALL+
546	24H LOUNGE CHAIR ARM
548	24H TASK CHAIR ARM
568	26H TASK CHAIR ARM
291	29H HIGH KNEE WALL
292	29H HIGH KNEE WALL+
4106	CUBE - LOUNGE HEIGHT
4108	CUBE - TASK HEIGHT
3100	PRIVACY SCREEN

Leg

L1	CORNER LEG
L2	ROUND LEG
L3	WOOD LEG

Leg Finish

Standard Powder Coat

BL	BLUE
BM	BLACK MATTE
BR	BRASS
BT	BLACK TWILIGHT
CP	CHAMPAGNE
DB	DARK BRONZE
DG	DARK GRAY
DP	DUSTY PINK
FG	FOREST GREEN
LG	LIGHT GRAY
MG	MEADOW GREEN
MK	MILK
MS	METALLIC SILVER
NK	NICKLE
NV	NAVY
OR	ORANGE
PY	PALE YELLOW
RD	RED
RO	RED ORANGE
RR	RUSTY RED
SB	SOFT BLUE
SD	SAND
TC	TERRACOTTA
TP	TAUPE
TS	TEXTURED SLATE
YL	YELLOW

Polished Metal

AL	POLISHED ALUMINUM
----	-------------------

Wood

81	WHITE OAK
83	NATURAL MAPLE
85	WALNUT
09	CUSTOM COLOR

5. Options

Ganging

SG	GANGING
----	---------

Power Cord Length

C1	10' CABLE
C2	20' CABLE

Power Port Position

1	POSITION 1
2	POSITION 2
3	POSITION 3
4	POSITION 4
5	POSITION 5
6	POSITION 6
7	POSITION 7
8	POSITION 8

Knee Wall

Flip Out Power

P10	9' CABLE
P20	19' CABLE

Power Port Color

Standard Powder Coat

BL	BLUE
BM	BLACK MATTE
BR	BRASS
BT	BLACK TWILIGHT
CP	CHAMPAGNE
DB	DARK BRONZE
DG	DARK GRAY
DP	DUSTY PINK
FG	FOREST GREEN
LG	LIGHT GRAY
MG	MEADOW GREEN
MK	MILK
MS	METALLIC SILVER
NK	NICKLE
NV	NAVY
OR	ORANGE
PY	PALE YELLOW
RD	RED
RO	RED ORANGE
RR	RUSTY RED
SB	SOFT BLUE
SD	SAND
TC	TERRACOTTA
TP	TAUPE
TS	TEXTURED SLATE
YL	YELLOW

6. Upholstery Style

Dual Upholstery

U1	MONO-COLOR WATERLINE
U2	DUAL-COLOR WATERLINE
U3	SEAT & BACK, NO WATERLINE
U4	SEAT & BACK, WITH WATERLINE
U8	TRI-COLOR - SEAT, BACK & WATERLINE

Textile Grades

COM	CUSTOMER'S OWN MATERIAL
A	GRADE A
B	GRADE B
C	GRADE C
D	GRADE D
E	GRADE E
F	GRADE F
G	GRADE G
H	GRADE H
I	GRADE I
J	GRADE J
K	GRADE K
L	GRADE L
M	GRADE M

Note: Select highest grade in the case of dual upholstery

Share

CHAIR: SINGLE-SEATER, LOUNGE HEIGHT

Textile Upholstery Grades

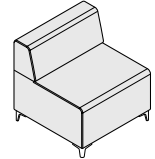
TITLE	SERIES	TYPE	SEAT	UPH	DIMENSIONS	YDG	COM	A	B	C	D	E	F	G	H	I	J	K	L	M	
 Chair, Single-Seater, Lounge Height	Standard Upholstery	SH	11	16	28W x 28D x 29H	2.8	2,141	2,367	2,492	2,615	2,737	2,862	2,999	3,137	3,297	3,503	3,751	3,855	4,090	4,287	
	Mono-Color Waterline	SH	11	16	U1	28W x 28D x 29H	2.8	2,324	2,553	2,676	2,800	2,923	3,047	3,185	3,321	3,481	3,688	3,936	4,038	4,273	4,470
	Dual-Color Waterline	SH	11	16	U2	28W x 28D x 29H	2.5 above Waterline 0.8 below Waterline	2,324	2,592	2,737	2,888	3,031	3,178	3,336	3,498	3,688	3,932	4,223	4,344	4,621	4,853
	No Waterline Back & Seat	SH	11	16	U3	28W x 28D x 29H	1.2 Back 1.6 Seat	2,141	2,367	2,492	2,615	2,737	2,862	2,999	3,137	3,297	3,503	3,751	3,855	4,090	4,287
	Waterline Back & Seat	SH	11	16	U4	28W x 28D x 29H	1.2 Back 1.6 Seat/below Waterline	2,324	2,553	2,676	2,800	2,923	3,047	3,185	3,321	3,481	3,688	3,936	4,038	4,273	4,470
	Triple-Back & Seat & Waterline	SH	11	16	U8	28W x 28D x 29H	0.8 below Waterline 1.2 Back 1.3 Seat/above Waterline	2,324	2,592	2,737	2,888	3,031	3,178	3,336	3,498	3,688	3,932	4,223	4,344	4,621	4,853

To Order Select Below

1. Series/Type/Seat

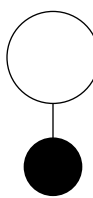

SH1116

Share
Chair, Single-Seater,
Lounge Height

2. Leg

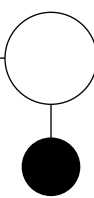

Leg

- L1 CORNER LEG, ADJ. PLASTIC GLIDES
- L2 ROUND LEG, ADJ. PLASTIC GLIDES
- L3 WOOD LEG

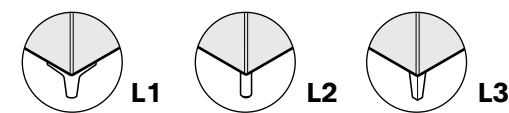

Mobility

The round leg glide has a larger diameter (1") than the corner leg for easier sliding on low pile carpet. Stylex is not responsible for damage to carpeting or floors.

3. Leg Finish

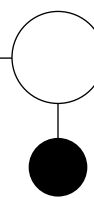

Standard Powder Coated Metal

- | | |
|--------------------|-------------------|
| BL BLUE | NK NICKEL |
| BM BLACK MATTE | NV NAVY |
| BR BRASS | OR ORANGE |
| BT BLACK TWILIGHT | PY PALE YELLOW |
| CP CHAMPAGNE | RD RED |
| DB DARK BRONZE | RO RED ORANGE |
| DG DARK GRAY | RR RUSTY RED |
| DP DUSTY PINK | SB SOFT BLUE |
| FG FOREST GREEN | SD SAND |
| LG LIGHT GRAY | TC TERRACOTTA |
| MG MEADOW GREEN | TP TAUPE |
| MK MILK | TS TEXTURED SLATE |
| MS METALLIC SILVER | YL YELLOW |

4. Options

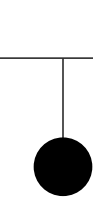

Polished Aluminum

AL POLISHED ALUMINUM

Wood Finish +215

- 81 WHITE OAK
- 83 NATURAL MAPLE
- 85 WALNUT

Custom Color Match

09 CUSTOM COLOR

Per order per color - 20 chair minimum.
Contact customer service for details.

5. Upholstery Style

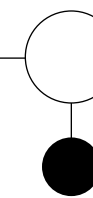

Ganging

SG GANGING **+51**

Used to connect chairs to adjacent chairs or benches.

Power

IN-SEAT POWER
C1X PORT W/10' CORD **+435**

IN-SEAT POWER
C2X PORT W/20' CORD **+466**

See [page 7](#) for power port spec info.

Power Port Finish

Power ports can be finished in any standard powder coat available.

6. Upholstery

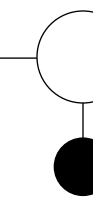

Upholstery Style

- U1 MONO-COLOR WATERLINE
- U2 DUAL-COLOR WATERLINE
- U3 SEAT & BACK, NO WATERLINE
- U4 SEAT & BACK, WITH WATERLINE
- U8 TRI-COLOR - SEAT, BACK & WATERLINE

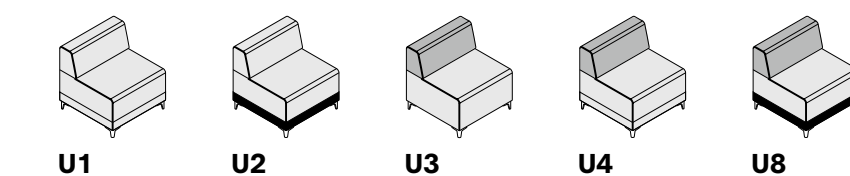

When pricing models with more than one fabric, the higher grade fabric will determine the overall grade of the specific product.

Upholstery

See [general information section](#) for details on textile program and COM/COL information.

Share will develop comfort wrinkles over time. The extent of these wrinkles is determined by the fabric specified.

Share

CHAIR: SINGLE-SEATER, TASK HEIGHT

Textile Upholstery Grades

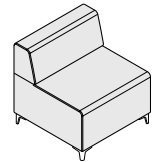
TITLE	SERIES	TYPE	SEAT	UPH	DIMENSIONS	YDG	COM	A	B	C	D	E	F	G	H	I	J	K	L	M	
 <p>Chair, Single-Seater, Task Height</p>	Standard Upholstery	SH	11	18	28W x 28D x 29H	2.8	2,141	2,367	2,492	2,615	2,737	2,862	2,999	3,137	3,297	3,503	3,751	3,855	4,090	4,287	
	Mono-Color Waterline	SH	11	18	U1	28W x 28D x 29H	2.8	2,324	2,553	2,676	2,800	2,923	3,047	3,185	3,321	3,481	3,688	3,936	4,038	4,273	4,470
	Dual-Color Waterline	SH	11	18	U2	28W x 28D x 29H	2.5 above Waterline 0.8 below Waterline	2,324	2,592	2,737	2,888	3,031	3,178	3,336	3,498	3,688	3,932	4,223	4,344	4,621	4,853
	No Waterline Back & Seat	SH	11	18	U3	28W x 28D x 29H	1.1 Back 1.7 Seat	2,141	2,367	2,492	2,615	2,737	2,862	2,999	3,137	3,297	3,503	3,751	3,855	4,090	4,287
	Waterline Back & Seat	SH	11	18	U4	28W x 28D x 29H	1.1 Back 1.7 Seat/below Waterline	2,324	2,553	2,676	2,800	2,923	3,047	3,185	3,321	3,481	3,688	3,936	4,038	4,273	4,470
	Triple-Back & Seat & Waterline	SH	11	18	U8	28W x 28D x 29H	0.8 below Waterline 1.1 Back 1.4 Seat/above Waterline	2,324	2,592	2,737	2,888	3,031	3,178	3,336	3,498	3,688	3,932	4,223	4,344	4,621	4,853

To Order Select Below

1. Series/Type/Seat

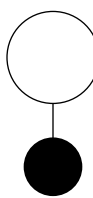

SH1118

Share
Chair, Single-Seater,
Task Height

2. Leg

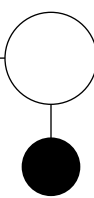

Leg

- L1 CORNER LEG, ADJ. PLASTIC GLIDES
- L2 ROUND LEG, ADJ. PLASTIC GLIDES
- L3 WOOD LEG

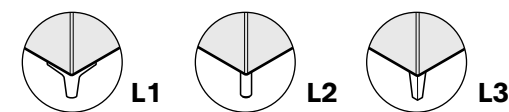

Mobility

The round leg glide has a larger diameter (1") than the corner leg for easier sliding on low pile carpet. Stylex is not responsible for damage to carpeting or floors.

3. Leg Finish

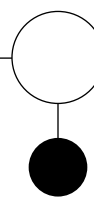

Standard Powder Coated Metal

- BL BLUE
- BM BLACK MATTE
- BR BRASS
- BT BLACK TWILIGHT
- CP CHAMPAGNE
- DB DARK BRONZE
- DG DARK GRAY
- DP DUSTY PINK
- FG FOREST GREEN
- LG LIGHT GRAY
- MG MEADOW GREEN
- MK MILK
- MS METALLIC SILVER

- NK NICKEL
- NV NAVY
- OR ORANGE
- PY PALE YELLOW
- RD RED
- RO RED ORANGE
- RR RUSTY RED
- SB SOFT BLUE
- SD SAND
- TC TERRACOTTA
- TP TAUPE
- TS TEXTURED SLATE
- YL YELLOW

4. Options

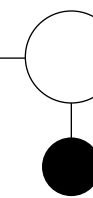

Ganging

- SG GANGING **+51**

Used to connect chairs to adjacent chairs or benches.

Power

- C1X IN-SEAT POWER PORT W/10' CORD **+435**
- C2X IN-SEAT POWER PORT W/20' CORD **+466**

See [page 7](#) for power port spec info.

Power Port Finish

Power ports can be finished in any standard powder coat available.

5. Upholstery Style

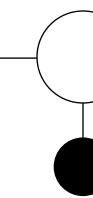

Upholstery Style

- U1 MONO-COLOR WATERLINE
- U2 DUAL-COLOR WATERLINE
- U3 SEAT & BACK, NO WATERLINE
- U4 SEAT & BACK, WITH WATERLINE
- U8 TRI-COLOR - SEAT, BACK & WATERLINE

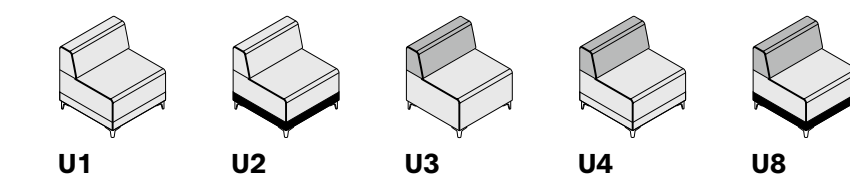

When pricing models with more than one fabric, the higher grade fabric will determine the overall grade of the specific product.

6. Upholstery

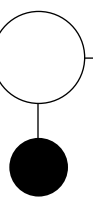

Upholstery

See [general information section](#) for details on textile program and COM/COL information.

Share will develop comfort wrinkles over time. The extent of these wrinkles is determined by the fabric specified.

Share

CHAIR: SINGLE-SEATER, BANQUETTE HEIGHT

Textile Upholstery Grades

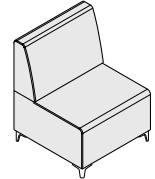
TITLE	SERIES	TYPE	SEAT	UPH	DIMENSIONS	YDG	COM	A	B	C	D	E	F	G	H	I	J	K	L	M	
 Chair, Single-Seater, Banquette Height	Standard Upholstery	SH	71	18	28W x 28D x 36H	3.1	2,428	2,681	2,818	2,951	3,088	3,227	3,377	3,530	3,705	3,938	4,212	4,314	4,577	4,766	
	Mono-Color Waterline	SH	71	18	U1	28W x 28D x 36H	3.1	2,611	2,863	3,002	3,136	3,273	3,410	3,561	3,712	3,890	4,121	4,396	4,491	4,751	4,946
	Dual-Color Waterline	SH	71	18	U2	28W x 28D x 36H	2.8 above Waterline 0.8 below Waterline	2,611	2,904	3,064	3,219	3,378	3,539	3,714	3,890	4,096	4,364	4,683	4,810	5,114	5,336
	No Waterline Back & Seat	SH	71	18	U3	28W x 28D x 36H	1.4 Back 1.7 Seat	2,428	2,681	2,818	2,951	3,088	3,227	3,377	3,530	3,705	3,938	4,212	4,314	4,577	4,766
	Waterline Back & Seat	SH	71	18	U4	28W x 28D x 36H	1.4 Back 1.8 Seat/below Waterline	2,611	2,863	3,002	3,136	3,273	3,410	3,561	3,712	3,890	4,121	4,396	4,491	4,751	4,946
	Triple-Back & Seat & Waterline	SH	71	18	U8	28W x 28D x 36H	0.8 below Waterline 1.4 Back 1.4 Seat/above Waterline	2,611	2,904	3,064	3,219	3,378	3,539	3,714	3,890	4,096	4,364	4,683	4,810	5,114	5,336

To Order Select Below

1. Series/Type/Seat

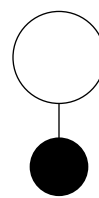

SH7118

Share
Chair, Single-Seater,
Banquette Height

2. Leg

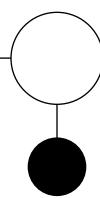

Leg

- L1 CORNER LEG, ADJ. PLASTIC GLIDES
- L2 ROUND LEG, ADJ. PLASTIC GLIDES
- L3 WOOD LEG

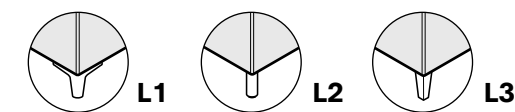

Mobility

The round leg glide has a larger diameter (1") than the corner leg for easier sliding on low pile carpet. Stylex is not responsible for damage to carpeting or floors.

3. Leg Finish

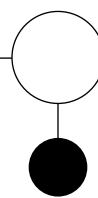

Standard Powder Coated Metal

- | | |
|--------------------|-------------------|
| BL BLUE | NK NICKEL |
| BM BLACK MATTE | NV NAVY |
| BR BRASS | OR ORANGE |
| BT BLACK TWILIGHT | PY PALE YELLOW |
| CP CHAMPAGNE | RD RED |
| DB DARK BRONZE | RO RED ORANGE |
| DG DARK GRAY | RR RUSTY RED |
| DP DUSTY PINK | SB SOFT BLUE |
| FG FOREST GREEN | SD SAND |
| LG LIGHT GRAY | TC TERRACOTTA |
| MG MEADOW GREEN | TP TAUPE |
| MK MILK | TS TEXTURED SLATE |
| MS METALLIC SILVER | YL YELLOW |

4. Options

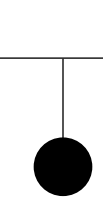

Polished Aluminum

AL POLISHED ALUMINUM

Wood Finish +215

- 81 WHITE OAK
- 83 NATURAL MAPLE
- 85 WALNUT

Custom Color Match

09 CUSTOM COLOR

Per order per color - 20 chair minimum.
Contact customer service for details.

5. Upholstery Style

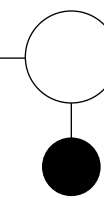

Ganging

SG GANGING **+51**

Used to connect chairs to adjacent chairs or benches.

Power

IN-SEAT POWER
C1X PORT W/10' CORD **+435**

IN-SEAT POWER
C2X PORT W/20' CORD **+466**

See [page 7](#) for power port spec info.

Power Port Finish

Power ports can be finished in any standard powder coat available.

6. Upholstery

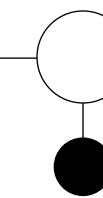

Upholstery Style

- U1 MONO-COLOR WATERLINE
- U2 DUAL-COLOR WATERLINE
- U3 SEAT & BACK, NO WATERLINE
- U4 SEAT & BACK, WITH WATERLINE
- U8 TRI-COLOR - SEAT, BACK & WATERLINE

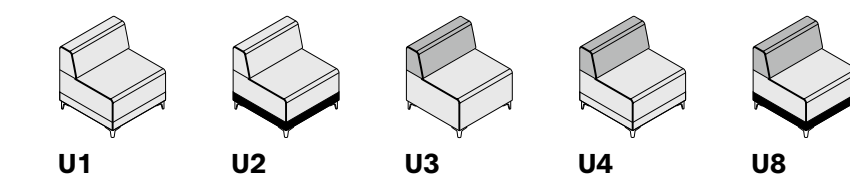

When pricing models with more than one fabric, the higher grade fabric will determine the overall grade of the specific product.

Upholstery

See [general information section](#) for details on textile program and COM/COL information.

Share will develop comfort wrinkles over time. The extent of these wrinkles is determined by the fabric specified.

Share

CHAIR: TWO-SEATER, LOUNGE HEIGHT

Textile Upholstery Grades

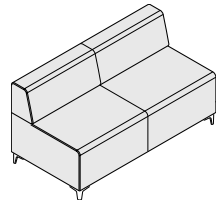
TITLE	SERIES	TYPE	SEAT	UPH	DIMENSIONS	YDG	COM	A	B	C	D	E	F	G	H	I	J	K	L	M
 Chair, Two-Seater, Lounge Height	Standard Upholstery	SH	11	26	56W x 28D x 29H	5.6	3,542	3,996	4,242	4,491	4,739	4,988	5,261	5,537	5,855	6,267	6,765	6,970	7,441	7,834
	Mono-Color Waterline	SH	11	26	56W x 28D x 29H	5.7	3,799	4,263	4,516	4,766	5,019	5,271	5,548	5,829	6,154	6,577	7,079	7,288	7,767	8,167
	Dual-Color Waterline	SH	11	26	56W x 28D x 29H	4.9 above Waterline 0.9 below Waterline	3,799	4,270	4,527	4,786	5,041	5,298	5,580	5,863	6,196	6,624	7,138	7,350	7,837	8,244
	No Waterline Back & Seat	SH	11	26	56W x 28D x 29H	2.4 Back 3.2 Seat	3,542	3,996	4,242	4,491	4,739	4,988	5,261	5,537	5,855	6,267	6,765	6,970	7,441	7,834
	Waterline Back & Seat	SH	11	26	56W x 28D x 29H	2.4 Back 3.2 Seat/below Waterline	3,799	4,263	4,516	4,766	5,019	5,271	5,548	5,829	6,154	6,577	7,079	7,227	7,698	8,091
	Triple-Back & Seat & Waterline	SH	11	26	56W x 28D x 29H	0.9 below Waterline 2.4 Back 2.5 Seat/above Waterline	3,799	4,270	4,527	4,786	5,041	5,298	5,580	5,863	6,196	6,624	7,138	7,350	7,837	8,244

To Order Select Below

1. Series/Type/Seat

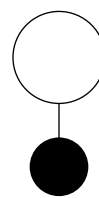

SH1126

Share
Chair, Two-Seater,
Lounge Height

2. Leg

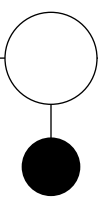

Leg

- L1 CORNER LEG, ADJ. PLASTIC GLIDES
- L2 ROUND LEG, ADJ. PLASTIC GLIDES
- L3 WOOD LEG

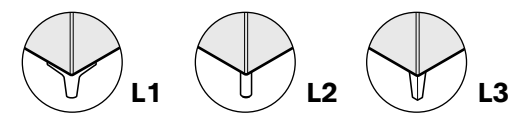

Mobility

The round leg glide has a larger diameter (1") than the corner leg for easier sliding on low pile carpet. Stylex is not responsible for damage to carpeting or floors.

3. Leg Finish

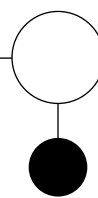

Standard Powder Coated Metal

- | | |
|--------------------|-------------------|
| BL BLUE | NK NICKEL |
| BM BLACK MATTE | NV NAVY |
| BR BRASS | OR ORANGE |
| BT BLACK TWILIGHT | PY PALE YELLOW |
| CP CHAMPAGNE | RD RED |
| DB DARK BRONZE | RO RED ORANGE |
| DG DARK GRAY | RR RUSTY RED |
| DP DUSTY PINK | SB SOFT BLUE |
| FG FOREST GREEN | SD SAND |
| LG LIGHT GRAY | TC TERRACOTTA |
| MG MEADOW GREEN | TP TAUPE |
| MK MILK | TS TEXTURED SLATE |
| MS METALLIC SILVER | YL YELLOW |

4. Options

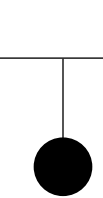

Polished Aluminum

AL POLISHED ALUMINUM

Wood Finish +215

- 81 WHITE OAK
- 83 NATURAL MAPLE
- 85 WALNUT

Custom Color Match

09 CUSTOM COLOR

Per order per color - 20 chair minimum.
Contact customer service for details.

5. Upholstery Style

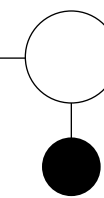

Ganging

SG GANGING **+51**

Used to connect chairs to adjacent chairs or benches.

Power

IN-SEAT POWER
C1X PORT W/10' CORD **+435**

IN-SEAT POWER
C2X PORT W/20' CORD **+466**

See [page 7](#) for power port spec info.

Power Port Finish

Power ports can be finished in any standard powder coat available.

6. Upholstery

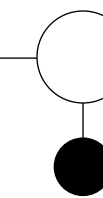

Upholstery Style

- U1 MONO-COLOR WATERLINE
- U2 DUAL-COLOR WATERLINE
- U3 SEAT & BACK, NO WATERLINE
- U4 SEAT & BACK, WITH WATERLINE
- U8 TRI-COLOR - SEAT, BACK & WATERLINE

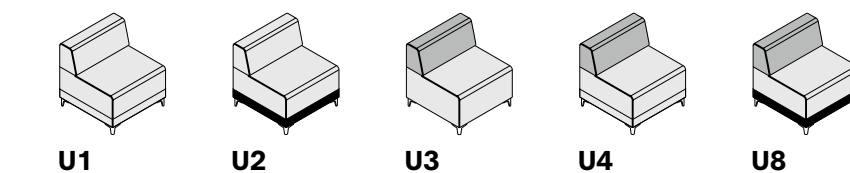

When pricing models with more than one fabric, the higher grade fabric will determine the overall grade of the specific product.

Upholstery

See [general information section](#) for details on textile program and COM/COL information.

Share will develop comfort wrinkles over time. The extent of these wrinkles is determined by the fabric specified.

Share

CHAIR: TWO-SEATER, TASK HEIGHT

Textile Upholstery Grades

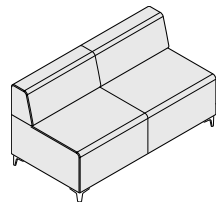
TITLE	SERIES	TYPE	SEAT	UPH	DIMENSIONS	YDG	COM	A	B	C	D	E	F	G	H	I	J	K	L	M
Chair, Two-Seater, Task Height 	Standard Upholstery	SH	11	28	56W x 28D x 29H	5.6	3,542	3,996	4,242	4,491	4,739	4,988	5,261	5,537	5,855	6,267	6,765	6,970	7,441	7,834
	Mono-Color Waterline	SH	11	28	56W x 28D x 29H	5.7	3,799	4,263	4,516	4,766	5,019	5,271	5,548	5,829	6,154	6,577	7,079	7,288	7,767	8,167
	Dual-Color Waterline	SH	11	28	56W x 28D x 29H	4.9 above Waterline 0.9 below Waterline	3,799	4,270	4,527	4,786	5,041	5,298	5,580	5,863	6,196	6,624	7,138	7,350	7,837	8,244
	No Waterline Back & Seat	SH	11	28	56W x 28D x 29H	2.2 Back 3.4 Seat	3,542	3,996	4,242	4,491	4,739	4,988	5,261	5,537	5,855	6,267	6,765	6,970	7,441	7,834
	Waterline Back & Seat	SH	11	28	56W x 28D x 29H	2.2 Back 3.4 Seat/below Waterline	3,799	4,263	4,516	4,766	5,019	5,271	5,548	5,829	6,154	6,577	7,079	7,227	7,698	8,091
	Triple-Back & Seat & Waterline	SH	11	28	56W x 28D x 29H	0.9 below Waterline 2.2 Back 2.7 Seat/above Waterline	3,799	4,270	4,527	4,786	5,041	5,298	5,580	5,863	6,196	6,624	7,138	7,350	7,837	8,244

To Order Select Below

1. Series/Type/Seat

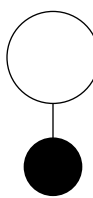

SH1128

Share
Chair, Two-Seater,
Task Height

2. Leg

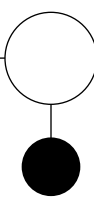

Leg

- L1 CORNER LEG, ADJ. PLASTIC GLIDES
- L2 ROUND LEG, ADJ. PLASTIC GLIDES
- L3 WOOD LEG

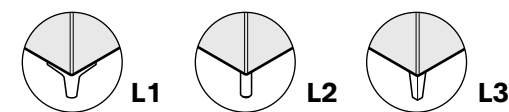

Mobility

The round leg glide has a larger diameter (1") than the corner leg for easier sliding on low pile carpet. Stylex is not responsible for damage to carpeting or floors.

3. Leg Finish

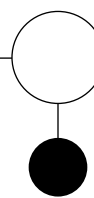

Standard Powder Coated Metal

- BL BLUE
- BM BLACK MATTE
- BR BRASS
- BT BLACK TWILIGHT
- CP CHAMPAGNE
- DB DARK BRONZE
- DG DARK GRAY
- DP DUSTY PINK
- FG FOREST GREEN
- LG LIGHT GRAY
- MG MEADOW GREEN
- MK MILK
- MS METALLIC SILVER

- NK NICKEL
- NV NAVY
- OR ORANGE
- PY PALE YELLOW
- RD RED
- RO RED ORANGE
- RR RUSTY RED
- SB SOFT BLUE
- SD SAND
- TC TERRACOTTA
- TP TAUPE
- TS TEXTURED SLATE
- YL YELLOW

4. Options

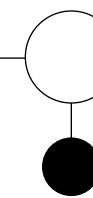

Ganging

- SG GANGING **+51**

Used to connect chairs to adjacent chairs or benches.

Power

- C1X IN-SEAT POWER PORT W/10' CORD **+435**
- C2X IN-SEAT POWER PORT W/20' CORD **+466**

See [page 7](#) for power port spec info.

Power Port Finish

Power ports can be finished in any standard powder coat available.

5. Upholstery Style

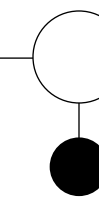

Upholstery Style

- U1 MONO-COLOR WATERLINE
- U2 DUAL-COLOR WATERLINE
- U3 SEAT & BACK, NO WATERLINE
- U4 SEAT & BACK, WITH WATERLINE
- U8 TRI-COLOR - SEAT, BACK & WATERLINE

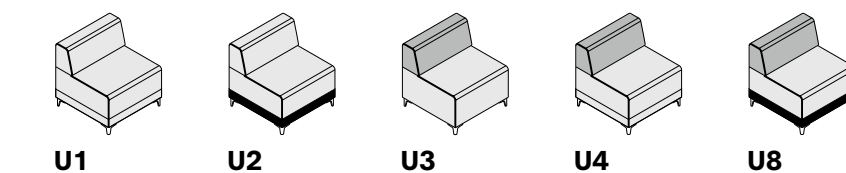

When pricing models with more than one fabric, the higher grade fabric will determine the overall grade of the specific product.

6. Upholstery

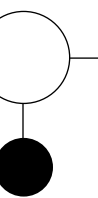

Upholstery

See [general information section](#) for details on textile program and COM/COL information.

Share will develop comfort wrinkles over time. The extent of these wrinkles is determined by the fabric specified.

Share

CHAIR: TWO-SEATER, BANQUETTE HEIGHT

Textile Upholstery Grades

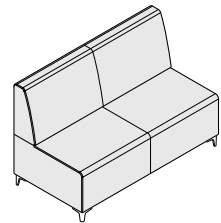
TITLE	SERIES	TYPE	SEAT	UPH	DIMENSIONS	YDG	COM	A	B	C	D	E	F	G	H	I	J	K	L	M
 Chair, Two-Seater, Banquette Height	Standard Upholstery	SH	71	28	56W x 28D x 36H	6.2	4,114	4,621	4,896	5,162	5,438	5,713	6,014	6,318	6,673	7,135	7,685	7,919	8,440	8,823
	Mono-Color Waterline	SH	71	28	56W x 28D x 36H	6.1	4,372	4,872	5,143	5,404	5,674	5,944	6,241	6,539	6,889	7,345	7,884	8,103	8,616	8,995
	Dual-Color Waterline	SH	71	28	56W x 28D x 36H	5.4 above Waterline 0.9 below Waterline	4,372	4,886	5,168	5,437	5,718	5,998	6,304	6,611	6,972	7,441	8,000	8,232	8,760	9,152
	No Waterline Back & Seat	SH	71	28	56W x 28D x 36H	2.7 Back 3.4 Seat	4,114	4,621	4,896	5,162	5,438	5,713	6,014	6,318	6,673	7,135	7,685	7,919	8,440	8,823
	Waterline Back & Seat	SH	71	28	56W x 28D x 36H	2.7 Back 3.5 Seat/below Waterline	4,372	4,872	5,143	5,404	5,674	5,944	6,241	6,539	6,889	7,345	7,884	8,103	8,616	8,995
	Triple-Back & Seat & Waterline	SH	71	28	56W x 28D x 36H	0.9 below Waterline 2.7 Back 2.7 Seat/above Waterline	4,372	4,886	5,168	5,437	5,718	5,998	6,304	6,611	6,972	7,441	8,000	8,232	8,760	9,152

To Order Select Below

1. Series/Type/Seat

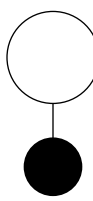

SH7128

Share
Chair, Two-Seater,
Banquette Height

2. Leg

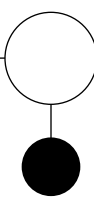

Leg

- L1 CORNER LEG, ADJ. PLASTIC GLIDES
- L2 ROUND LEG, ADJ. PLASTIC GLIDES
- L3 WOOD LEG

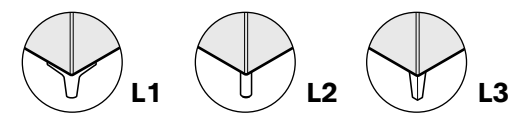

Mobility

The round leg glide has a larger diameter (1") than the corner leg for easier sliding on low pile carpet. Stylex is not responsible for damage to carpeting or floors.

3. Leg Finish

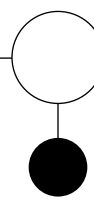

Standard Powder Coated Metal

- | | |
|--------------------|-------------------|
| BL BLUE | NK NICKEL |
| BM BLACK MATTE | NV NAVY |
| BR BRASS | OR ORANGE |
| BT BLACK TWILIGHT | PY PALE YELLOW |
| CP CHAMPAGNE | RD RED |
| DB DARK BRONZE | RO RED ORANGE |
| DG DARK GRAY | RR RUSTY RED |
| DP DUSTY PINK | SB SOFT BLUE |
| FG FOREST GREEN | SD SAND |
| LG LIGHT GRAY | TC TERRACOTTA |
| MG MEADOW GREEN | TP TAUPE |
| MK MILK | TS TEXTURED SLATE |
| MS METALLIC SILVER | YL YELLOW |

Polished Aluminum

- AL POLISHED ALUMINUM

Wood Finish +215

- 81 WHITE OAK
- 83 NATURAL MAPLE
- 85 WALNUT

Custom Color Match

- 09 CUSTOM COLOR

Per order per color - 20 chair minimum.
Contact customer service for details.

4. Options

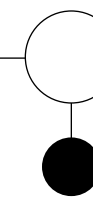

Ganging

- SG GANGING **+51**

Used to connect chairs to adjacent chairs or benches.

Power

- IN-SEAT POWER
C1X PORT W/10' CORD **+435**
- IN-SEAT POWER
C2X PORT W/20' CORD **+466**

See [page 7](#) for power port spec info.

Power Port Finish

Power ports can be finished in any standard powder coat available.

5. Upholstery Style

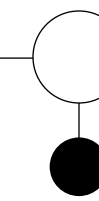

Upholstery Style

- U1 MONO-COLOR WATERLINE
- U2 DUAL-COLOR WATERLINE
- U3 SEAT & BACK, NO WATERLINE
- U4 SEAT & BACK, WITH WATERLINE
- U8 TRI-COLOR - SEAT, BACK & WATERLINE

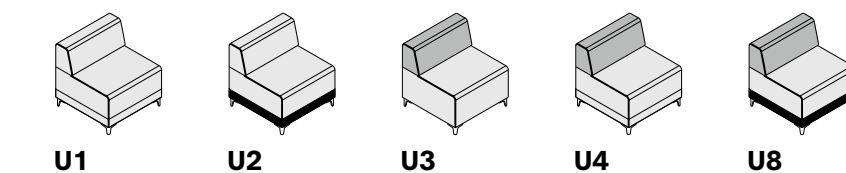

When pricing models with more than one fabric, the higher grade fabric will determine the overall grade of the specific product.

6. Upholstery

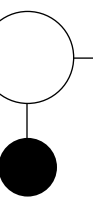

Upholstery

See [general information section](#) for details on textile program and COM/COL information.

Share will develop comfort wrinkles over time. The extent of these wrinkles is determined by the fabric specified.

Share

CHAIR: THREE-SEATER, LOUNGE HEIGHT

Textile Upholstery Grades

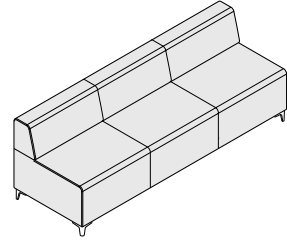
TITLE	SERIES	TYPE	SEAT	UPH	DIMENSIONS	YDG	COM	A	B	C	D	E	F	G	H	I	J	K	L	M	
Chair, Three-Seater, Lounge Height 	Standard Upholstery	SH	11	36	84W x 28D x 29H	8.5	4,870	5,560	5,938	6,311	6,690	7,063	7,478	7,893	8,380	9,009	9,762	10,073	10,788	11,384	
	Mono-Color Waterline	SH	11	36	U1	84W x 28D x 29H	8.5	5,240	5,929	6,305	6,684	7,057	7,436	7,849	8,264	8,751	9,379	10,131	10,443	11,158	11,754
	Dual-Color Waterline	SH	11	36	U2	84W x 28D x 29H	7.3 above Waterline 1.6 below Waterline	5,240	5,960	6,355	6,749	7,143	7,537	7,971	8,404	8,916	9,572	10,360	10,688	11,436	12,061
	No Waterline Back & Seat	SH	11	36	U3	84W x 28D x 29H	3.6 Back 4.9 Seat	4,870	5,560	5,938	6,311	6,690	7,063	7,478	7,893	8,380	9,009	9,762	10,073	10,788	11,384
	Waterline Back & Seat	SH	11	36	U4	84W x 28D x 29H	3.6 Back 4.9 Seat/below Waterline	5,240	5,929	6,305	6,684	7,057	7,436	7,849	8,264	8,751	9,379	10,131	10,443	11,158	11,754
	Triple-Back & Seat & Waterline	SH	11	36	U8	84W x 28D x 29H	1.6 below Waterline 3.6 Back 3.7 Seat/above Waterline	5,240	5,960	6,355	6,749	7,143	7,537	7,971	8,404	8,916	9,572	10,360	10,688	11,436	12,061

To Order Select Below

1. Series/Type/Seat

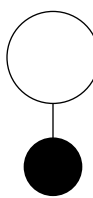

SH1136

Share
Chair, Three-Seater,
Lounge Height

2. Leg

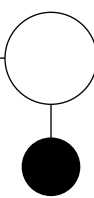

Leg

- L1 CORNER LEG, ADJ. PLASTIC GLIDES
- L2 ROUND LEG, ADJ. PLASTIC GLIDES
- L3 WOOD LEG

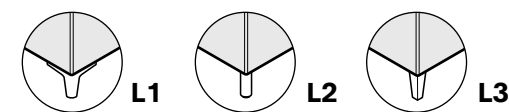

Mobility

The round leg glide has a larger diameter (1") than the corner leg for easier sliding on low pile carpet. Stylex is not responsible for damage to carpeting or floors.

3. Leg Finish

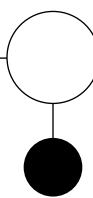

Standard Powder Coated Metal

- BL BLUE
- BM BLACK MATTE
- BR BRASS
- BT BLACK TWILIGHT
- CP CHAMPAGNE
- DB DARK BRONZE
- DG DARK GRAY
- DP DUSTY PINK
- FG FOREST GREEN
- LG LIGHT GRAY
- MG MEADOW GREEN
- MK MILK
- MS METALLIC SILVER

- NK NICKEL
- NV NAVY
- OR ORANGE
- PY PALE YELLOW
- RD RED
- RO RED ORANGE
- RR RUSTY RED
- SB SOFT BLUE
- SD SAND
- TC TERRACOTTA
- TP TAUPE
- TS TEXTURED SLATE
- YL YELLOW

4. Options

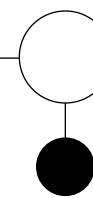

Ganging

- SG GANGING **+51**

Used to connect chairs to adjacent chairs or benches.

Power

- IN-SEAT POWER
C1X PORT W/10' CORD **+435**
- IN-SEAT POWER
C2X PORT W/20' CORD **+466**

See [page 7](#) for power port spec info.

Power Port Finish

Power ports can be finished in any standard powder coat available.

5. Upholstery Style

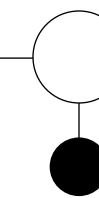

Upholstery Style

- U1 MONO-COLOR WATERLINE
- U2 DUAL-COLOR WATERLINE
- U3 SEAT & BACK, NO WATERLINE
- U4 SEAT & BACK, WITH WATERLINE
- U8 TRI-COLOR - SEAT, BACK & WATERLINE

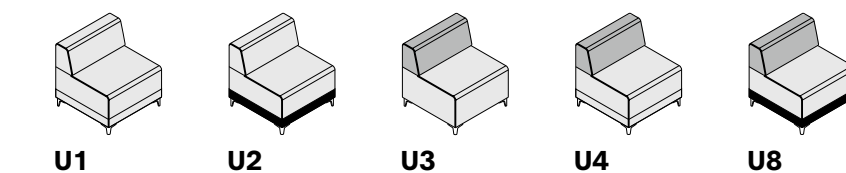

When pricing models with more than one fabric, the higher grade fabric will determine the overall grade of the specific product.

6. Upholstery

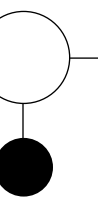

Upholstery

See [general information section](#) for details on textile program and COM/COL information.

Share will develop comfort wrinkles over time. The extent of these wrinkles is determined by the fabric specified.

Share

CHAIR: THREE-SEATER, TASK HEIGHT

Textile Upholstery Grades

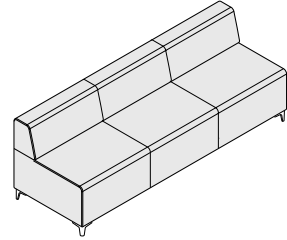
TITLE	SERIES	TYPE	SEAT	UPH	DIMENSIONS	YDG	COM	A	B	C	D	E	F	G	H	I	J	K	L	M	
Chair, Three-Seater, Task Height 	Standard Upholstery	SH	11	38	84W x 28D x 29H	8.5	4,870	5,560	5,938	6,311	6,690	7,063	7,478	7,893	8,380	9,009	9,762	10,073	10,788	11,384	
	Mono-Color Waterline	SH	11	38	U1	84W x 28D x 29H	8.5	5,240	5,929	6,305	6,684	7,057	7,436	7,849	8,264	8,751	9,379	10,131	10,443	11,158	11,754
	Dual-Color Waterline	SH	11	38	U2	84W x 28D x 29H	7.3 above Waterline 1.6 below Waterline	5,240	5,960	6,355	6,749	7,143	7,537	7,971	8,404	8,916	9,572	10,360	10,688	11,436	12,061
	No Waterline Back & Seat	SH	11	38	U3	84W x 28D x 29H	3.3 Back 5.2 Seat	4,870	5,560	5,938	6,311	6,690	7,063	7,478	7,893	8,380	9,009	9,762	10,073	10,788	11,384
	Waterline Back & Seat	SH	11	38	U4	84W x 28D x 29H	3.3 Back 5.2 Seat/below Waterline	5,240	5,929	6,305	6,684	7,057	7,436	7,849	8,264	8,751	9,379	10,131	10,443	11,158	11,754
	Triple-Back & Seat & Waterline	SH	11	38	U8	84W x 28D x 29H	1.6 below Waterline 3.3 Back 4 Seat/above Waterline	5,240	5,960	6,355	6,749	7,143	7,537	7,971	8,404	8,916	9,572	10,360	10,688	11,436	12,061

To Order Select Below

1. Series/Type/Seat

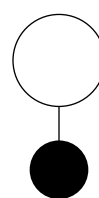

SH1138

Share
Chair, Three-Seater,
Task Height

2. Leg

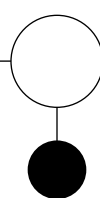

Leg

- L1 CORNER LEG, ADJ. PLASTIC GLIDES
- L2 ROUND LEG, ADJ. PLASTIC GLIDES
- L3 WOOD LEG

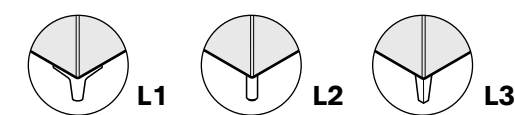

Mobility

The round leg glide has a larger diameter (1") than the corner leg for easier sliding on low pile carpet. Stylex is not responsible for damage to carpeting or floors.

3. Leg Finish

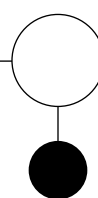

Standard Powder Coated Metal

- | | |
|--------------------|-------------------|
| BL BLUE | NK NICKEL |
| BM BLACK MATTE | NV NAVY |
| BR BRASS | OR ORANGE |
| BT BLACK TWILIGHT | PY PALE YELLOW |
| CP CHAMPAGNE | RD RED |
| DB DARK BRONZE | RO RED ORANGE |
| DG DARK GRAY | RR RUSTY RED |
| DP DUSTY PINK | SB SOFT BLUE |
| FG FOREST GREEN | SD SAND |
| LG LIGHT GRAY | TC TERRACOTTA |
| MG MEADOW GREEN | TP TAUPE |
| MK MILK | TS TEXTURED SLATE |
| MS METALLIC SILVER | YL YELLOW |

Polished Aluminum

AL POLISHED ALUMINUM

Wood Finish +215

- 81 WHITE OAK
- 83 NATURAL MAPLE
- 85 WALNUT

Custom Color Match

09 CUSTOM COLOR

Per order per color - 20 chair minimum.
Contact customer service for details.

4. Options

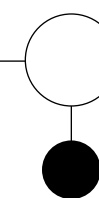

Ganging

SG GANGING **+51**

Used to connect chairs to adjacent chairs or benches.

Power

IN-SEAT POWER
C1X PORT W/10' CORD **+435**

IN-SEAT POWER
C2X PORT W/20' CORD **+466**

See [page 7](#) for power port spec info.

Power Port Finish

Power ports can be finished in any standard powder coat available.

5. Upholstery Style

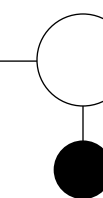

Upholstery Style

- U1 MONO-COLOR WATERLINE
- U2 DUAL-COLOR WATERLINE
- U3 SEAT & BACK, NO WATERLINE
- U4 SEAT & BACK, WITH WATERLINE
- U8 TRI-COLOR - SEAT, BACK & WATERLINE

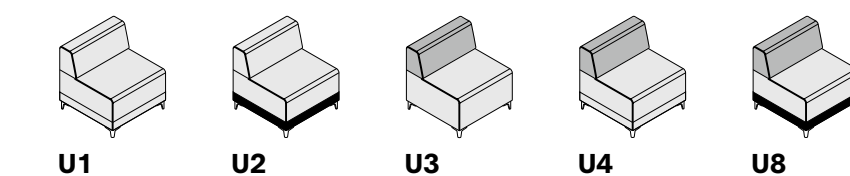

When pricing models with more than one fabric, the higher grade fabric will determine the overall grade of the specific product.

6. Upholstery

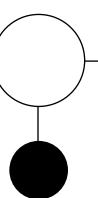

Upholstery

See [general information section](#) for details on textile program and COM/COL information.

Share will develop comfort wrinkles over time. The extent of these wrinkles is determined by the fabric specified.

Share

CHAIR: THREE-SEATER, BANQUETTE HEIGHT

Textile Upholstery Grades

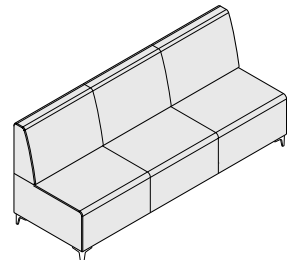
TITLE	SERIES	TYPE	SEAT	UPH	DIMENSIONS	YDG	COM	A	B	C	D	E	F	G	H	I	J	K	L	M	
 <p>Chair, Three-Seater, Banquette Height</p>	Standard Upholstery	SH	71	38	84W x 28D x 36H	9.2	5,729	6,480	6,889	7,284	7,694	8,102	8,549	8,999	9,526	10,210	11,026	11,390	12,161	12,733	
	Mono-Color Waterline	SH	71	38	U1	84W x 28D x 36H	9.1	5,986	6,731	7,135	7,525	7,930	8,334	8,777	9,219	9,742	10,420	11,227	11,572	12,338	12,902
	Dual-Color Waterline	SH	71	38	U2	84W x 28D x 36H	8 above Waterline 1.6 below Waterline	5,986	6,770	7,197	7,609	8,036	8,462	8,928	9,399	9,949	10,664	11,515	11,892	12,700	13,294
	No Waterline Back & Seat	SH	71	38	U3	84W x 28D x 36H	4 Back 5.1 Seat	5,729	6,480	6,889	7,284	7,694	8,102	8,549	8,999	9,526	10,210	11,026	11,390	12,161	12,733
	Waterline Back & Seat	SH	71	38	U4	84W x 28D x 36H	4 Back 5.2 Seat/below Waterline	5,986	6,731	7,135	7,525	7,930	8,334	8,777	9,219	9,742	10,420	11,227	11,572	12,338	12,902
	Triple-Back & Seat & Waterline	SH	71	38	U8	84W x 28D x 36H	1.6 below Waterline 4 Back 4 Seat/above Waterline	5,986	6,770	7,197	7,609	8,036	8,462	8,928	9,399	9,949	10,664	11,515	11,892	12,700	13,294

To Order Select Below

1. Series/Type/Seat

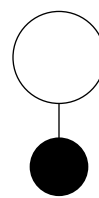

SH7138

Share
Chair, Three-Seater,
Banquette Height

2. Leg

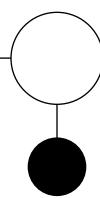

Leg

- L1 CORNER LEG, ADJ. PLASTIC GLIDES
- L2 ROUND LEG, ADJ. PLASTIC GLIDES
- L3 WOOD LEG

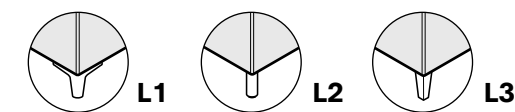

Mobility

The round leg glide has a larger diameter (1") than the corner leg for easier sliding on low pile carpet. Stylex is not responsible for damage to carpeting or floors.

3. Leg Finish

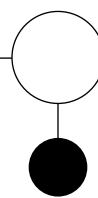

Standard Powder Coated Metal

- | | |
|--------------------|-------------------|
| BL BLUE | NK NICKEL |
| BM BLACK MATTE | NV NAVY |
| BR BRASS | OR ORANGE |
| BT BLACK TWILIGHT | PY PALE YELLOW |
| CP CHAMPAGNE | RD RED |
| DB DARK BRONZE | RO RED ORANGE |
| DG DARK GRAY | RR RUSTY RED |
| DP DUSTY PINK | SB SOFT BLUE |
| FG FOREST GREEN | SD SAND |
| LG LIGHT GRAY | TC TERRACOTTA |
| MG MEADOW GREEN | TP TAUPE |
| MK MILK | TS TEXTURED SLATE |
| MS METALLIC SILVER | YL YELLOW |

4. Options

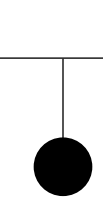

Polished Aluminum

AL POLISHED ALUMINUM

Wood Finish +215

- 81 WHITE OAK
- 83 NATURAL MAPLE
- 85 WALNUT

Custom Color Match

09 CUSTOM COLOR

Per order per color - 20 chair minimum.
Contact customer service for details.

4. Options

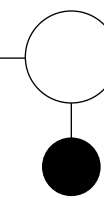

Ganging

SG GANGING **+51**

Used to connect chairs to adjacent chairs or benches.

Power

IN-SEAT POWER
C1X PORT W/10' CORD **+435**

IN-SEAT POWER
C2X PORT W/20' CORD **+466**

See [page 7](#) for power port spec info.

Power Port Finish

Power ports can be finished in any standard powder coat available.

5. Upholstery Style

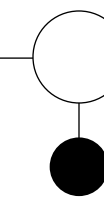

Upholstery Style

- U1 MONO-COLOR WATERLINE
- U2 DUAL-COLOR WATERLINE
- U3 SEAT & BACK, NO WATERLINE
- U4 SEAT & BACK, WITH WATERLINE
- U8 TRI-COLOR - SEAT, BACK & WATERLINE

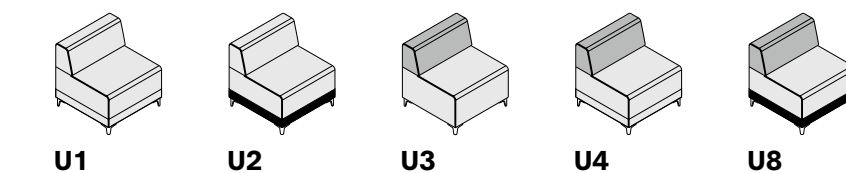

When pricing models with more than one fabric, the higher grade fabric will determine the overall grade of the specific product.

6. Upholstery

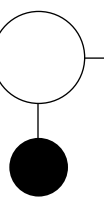

Upholstery

See [general information section](#) for details on textile program and COM/COL information.

Share will develop comfort wrinkles over time. The extent of these wrinkles is determined by the fabric specified.

Share

CHAIR: 90° CORNER, LOUNGE HEIGHT

Textile Upholstery Grades

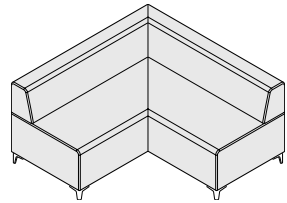
TITLE	SERIES	TYPE	SEAT	UPH	DIMENSIONS	YDG	COM	A	B	C	D	E	F	G	H	I	J	K	L	M
Chair, 90° Corner, Lounge Height 	Standard Upholstery	SH	12	26	56W x 28D x 29H	8	5,312	5,960	6,314	6,671	7,025	7,377	7,768	8,159	8,618	9,207	9,917	10,209	10,881	11,443
	Mono-Color Waterline	SH	12	26	56W x 28D x 29H	8.1	5,682	6,339	6,696	7,056	7,414	7,773	8,166	8,562	9,029	9,625	10,343	10,641	11,321	11,889
	Dual-Color Waterline	SH	12	26	56W x 28D x 29H	6.9 above Waterline 1.6 below Waterline	5,682	6,372	6,747	7,124	7,499	7,876	8,291	8,705	9,195	9,820	10,572	10,885	11,600	12,196
	No Waterline Back & Seat	SH	12	26	56W x 28D x 29H	3.6 Back 4.4 Seat	5,312	5,960	6,314	6,671	7,025	7,377	7,768	8,159	8,618	9,207	9,917	10,209	10,881	11,443
	Waterline Back & Seat	SH	12	26	56W x 28D x 29H	3.6 Back 4.4 Seat/below Waterline	5,682	6,339	6,696	7,056	7,414	7,773	8,166	8,562	9,029	9,625	10,343	10,579	11,251	11,813
	Triple-Back & Seat & Waterline	SH	12	26	56W x 28D x 29H	1.6 below Waterline 3.6 Back 3.3 Seat/above Waterline	5,682	6,372	6,747	7,124	7,499	7,876	8,291	8,705	9,195	9,820	10,572	10,885	11,600	12,196

To Order Select Below

1. Series/Type/Seat

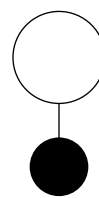

SH1226

Share
Chair, 90° Corner
Lounge Height

2. Leg

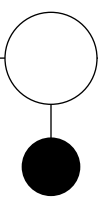

Leg

- L1 CORNER LEG, ADJ. PLASTIC GLIDES
- L2 ROUND LEG, ADJ. PLASTIC GLIDES
- L3 WOOD LEG

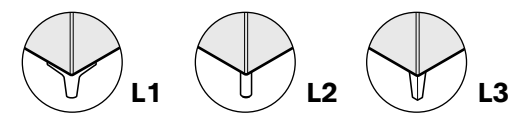

Mobility

The round leg glide has a larger diameter (1") than the corner leg for easier sliding on low pile carpet. Stylex is not responsible for damage to carpeting or floors.

3. Leg Finish

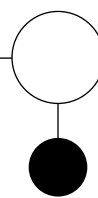

Standard Powder Coated Metal

- | | |
|--------------------|-------------------|
| BL BLUE | NK NICKEL |
| BM BLACK MATTE | NV NAVY |
| BR BRASS | OR ORANGE |
| BT BLACK TWILIGHT | PY PALE YELLOW |
| CP CHAMPAGNE | RD RED |
| DB DARK BRONZE | RO RED ORANGE |
| DG DARK GRAY | RR RUSTY RED |
| DP DUSTY PINK | SB SOFT BLUE |
| FG FOREST GREEN | SD SAND |
| LG LIGHT GRAY | TC TERRACOTTA |
| MG MEADOW GREEN | TP TAUPE |
| MK MILK | TS TEXTURED SLATE |
| MS METALLIC SILVER | YL YELLOW |

4. Options

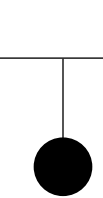

Polished Aluminum

AL POLISHED ALUMINUM

Wood Finish +215

- 81 WHITE OAK
- 83 NATURAL MAPLE
- 85 WALNUT

Custom Color Match

09 CUSTOM COLOR

Per order per color - 20 chair minimum.
Contact customer service for details.

5. Upholstery Style

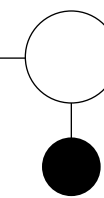

Ganging

SG GANGING **+51**

Used to connect chairs to adjacent chairs or benches.

Power

IN-SEAT POWER
C1X PORT W/10' CORD **+435**

IN-SEAT POWER
C2X PORT W/20' CORD **+466**

See [page 7](#) for power port spec info.

Power Port Finish

Power ports can be finished in any standard powder coat available.

6. Upholstery

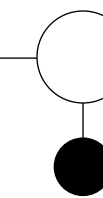

Upholstery Style

- U1 MONO-COLOR WATERLINE
- U2 DUAL-COLOR WATERLINE
- U3 SEAT & BACK, NO WATERLINE
- U4 SEAT & BACK, WITH WATERLINE
- U8 TRI-COLOR - SEAT, BACK & WATERLINE

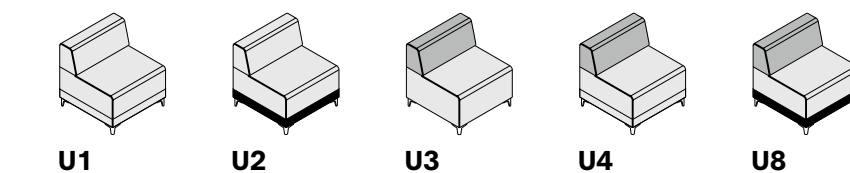

When pricing models with more than one fabric, the higher grade fabric will determine the overall grade of the specific product.

Upholstery

See [general information section](#) for details on textile program and COM/COL information.

Share will develop comfort wrinkles over time. The extent of these wrinkles is determined by the fabric specified.

Share

CHAIR: 90° CORNER, TASK HEIGHT

Textile Upholstery Grades

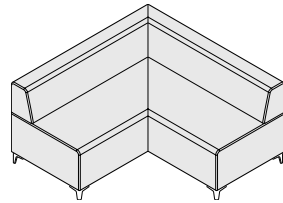
TITLE	SERIES	TYPE	SEAT	UPH	DIMENSIONS	YDG	COM	A	B	C	D	E	F	G	H	I	J	K	L	M
Chair, 90° Corner, Task Height 	Standard Upholstery	SH	12	28	56W x 28D x 29H	8.5	5,312	6,004	6,381	6,756	7,132	7,511	7,921	8,335	8,822	9,451	10,203	10,515	11,230	11,826
	Mono-Color Waterline	SH	12	28	56W x 28D x 29H	8.5	5,682	6,372	6,747	7,124	7,499	7,876	8,291	8,705	9,195	9,820	10,572	10,885	11,600	12,196
	Dual-Color Waterline	SH	12	28	56W x 28D x 29H	7.4 above Waterline 1.6 below Waterline	5,682	6,410	6,809	7,209	7,607	8,006	8,445	8,882	9,400	10,063	10,859	11,192	11,948	12,579
	No Waterline Back & Seat	SH	12	28	56W x 28D x 29H	3.7 Back 4.8 Seat	5,312	6,004	6,381	6,756	7,132	7,511	7,921	8,335	8,822	9,451	10,203	10,515	11,230	11,826
	Waterline Back & Seat	SH	12	28	56W x 28D x 29H	3.7 Back 4.8 Seat/below Waterline	5,682	6,372	6,747	7,124	7,499	7,876	8,291	8,705	9,195	9,820	10,572	10,885	11,600	12,196
	Triple-Back & Seat & Waterline	SH	12	28	56W x 28D x 29H	1.6 below Waterline 3.7 Back 3.7 Seat/above Waterline	5,682	6,410	6,809	7,209	7,607	8,006	8,445	8,882	9,400	10,063	10,859	11,192	11,948	12,579

To Order Select Below

1. Series/Type/Seat

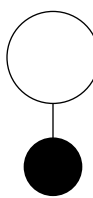

SH1228

Share
Chair, 90° Corner
Task Height

2. Leg

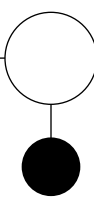

Leg

- L1 CORNER LEG, ADJ. PLASTIC GLIDES
- L2 ROUND LEG, ADJ. PLASTIC GLIDES
- L3 WOOD LEG

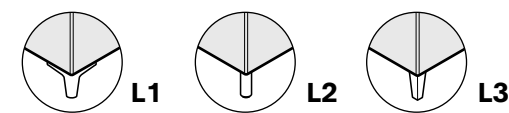

Mobility

The round leg glide has a larger diameter (1") than the corner leg for easier sliding on low pile carpet. Stylex is not responsible for damage to carpeting or floors.

3. Leg Finish

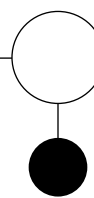

Standard Powder Coated Metal

- | | |
|--------------------|-------------------|
| BL BLUE | NK NICKEL |
| BM BLACK MATTE | NV NAVY |
| BR BRASS | OR ORANGE |
| BT BLACK TWILIGHT | PY PALE YELLOW |
| CP CHAMPAGNE | RD RED |
| DB DARK BRONZE | RO RED ORANGE |
| DG DARK GRAY | RR RUSTY RED |
| DP DUSTY PINK | SB SOFT BLUE |
| FG FOREST GREEN | SD SAND |
| LG LIGHT GRAY | TC TERRACOTTA |
| MG MEADOW GREEN | TP TAUPE |
| MK MILK | TS TEXTURED SLATE |
| MS METALLIC SILVER | YL YELLOW |

4. Options

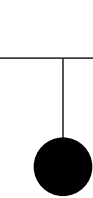

Polished Aluminum

AL POLISHED ALUMINUM

Wood Finish +215

- 81 WHITE OAK
- 83 NATURAL MAPLE
- 85 WALNUT

Custom Color Match

09 CUSTOM COLOR

Per order per color - 20 chair minimum.
Contact customer service for details.

5. Upholstery Style

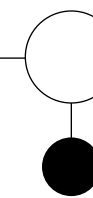

Ganging

SG GANGING **+51**

Used to connect chairs to adjacent chairs or benches.

Power

IN-SEAT POWER
C1X PORT W/10' CORD **+435**

IN-SEAT POWER
C2X PORT W/20' CORD **+466**

See [page 7](#) for power port spec info.

Power Port Finish

Power ports can be finished in any standard powder coat available.

6. Upholstery

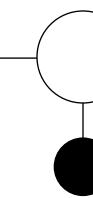

Upholstery Style

- U1 MONO-COLOR WATERLINE
- U2 DUAL-COLOR WATERLINE
- U3 SEAT & BACK, NO WATERLINE
- U4 SEAT & BACK, WITH WATERLINE
- U8 TRI-COLOR - SEAT, BACK & WATERLINE

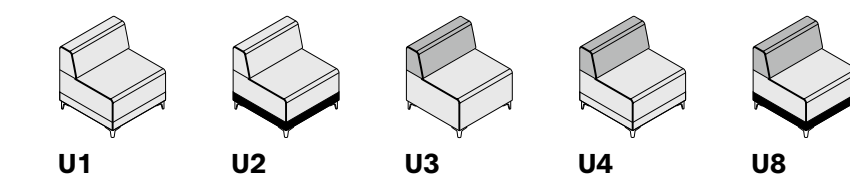

When pricing models with more than one fabric, the higher grade fabric will determine the overall grade of the specific product.

Upholstery

See [general information section](#) for details on textile program and COM/COL information.

Share will develop comfort wrinkles over time. The extent of these wrinkles is determined by the fabric specified.

Share

CHAIR: 90° CORNER, BANQUETTE HEIGHT

Textile Upholstery Grades

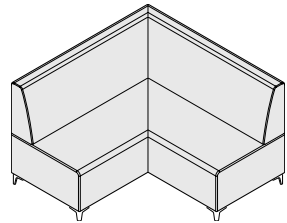
TITLE	SERIES	TYPE	SEAT	UPH	DIMENSIONS	YDG	COM	A	B	C	D	E	F	G	H	I	J	K	L	M	
Chair, 90° Corner, Banquette Height 	Standard Upholstery	SH	72	28	56W x 28D x 36H	9.2	6,459	7,209	7,620	8,015	8,422	8,832	9,280	9,727	10,254	10,940	11,756	12,091	12,865	13,433	
	Mono-Color Waterline	SH	72	28	U1	56W x 28D x 36H	9.1	6,828	7,572	7,977	8,367	8,771	9,174	9,617	10,061	10,583	11,260	12,068	12,381	13,148	13,711
	Dual-Color Waterline	SH	72	28	U2	56W x 28D x 36H	8.1 above Waterline 1.6 below Waterline	6,828	7,621	8,050	8,466	8,898	9,328	9,803	10,274	10,830	11,553	12,415	12,767	13,581	14,180
	No Waterline Back & Seat	SH	72	28	U3	56W x 28D x 36H	4.4 Back 4.8 Seat	6,459	7,209	7,620	8,015	8,422	8,832	9,280	9,727	10,254	10,940	11,756	12,091	12,865	13,433
	Waterline Back & Seat	SH	72	28	U4	56W x 28D x 36H	4.4 Back 4.9 Seat/below Waterline	6,828	7,572	7,977	8,367	8,771	9,174	9,617	10,061	10,583	11,260	12,068	12,381	13,148	13,711
	Triple-Back & Seat & Waterline	SH	72	28	U8	56W x 28D x 36H	1.6 below Waterline 4.4 Back 3.7 Seat/above Waterline	6,828	7,621	8,050	8,466	8,898	9,328	9,803	10,274	10,830	11,553	12,415	12,767	13,581	14,180

To Order Select Below

1. Series/Type/Seat

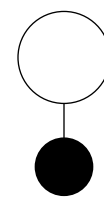

SH7228

Share
Chair, 90° Corner
Banquette Height

2. Leg

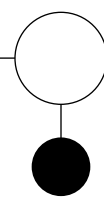

Leg

- L1 CORNER LEG, ADJ. PLASTIC GLIDES
- L2 ROUND LEG, ADJ. PLASTIC GLIDES
- L3 WOOD LEG

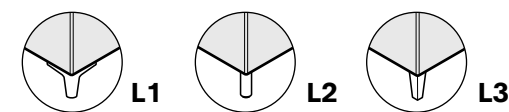

Mobility

The round leg glide has a larger diameter (1") than the corner leg for easier sliding on low pile carpet. Stylex is not responsible for damage to carpeting or floors.

3. Leg Finish

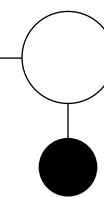

Standard Powder Coated Metal

- | | |
|--------------------|-------------------|
| BL BLUE | NK NICKEL |
| BM BLACK MATTE | NV NAVY |
| BR BRASS | OR ORANGE |
| BT BLACK TWILIGHT | PY PALE YELLOW |
| CP CHAMPAGNE | RD RED |
| DB DARK BRONZE | RO RED ORANGE |
| DG DARK GRAY | RR RUSTY RED |
| DP DUSTY PINK | SB SOFT BLUE |
| FG FOREST GREEN | SD SAND |
| LG LIGHT GRAY | TC TERRACOTTA |
| MG MEADOW GREEN | TP TAUPE |
| MK MILK | TS TEXTURED SLATE |
| MS METALLIC SILVER | YL YELLOW |

4. Options

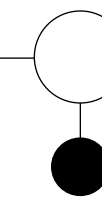

Ganging

- SG GANGING **+51**

Used to connect chairs to adjacent chairs or benches.

Power

- C1X IN-SEAT POWER PORT W/10' CORD **+435**
- C2X IN-SEAT POWER PORT W/20' CORD **+466**

See [page 7](#) for power port spec info.

Power Port Finish

Power ports can be finished in any standard powder coat available.

5. Upholstery Style

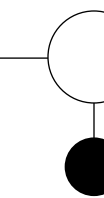

Upholstery Style

- U1 MONO-COLOR WATERLINE
- U2 DUAL-COLOR WATERLINE
- U3 SEAT & BACK, NO WATERLINE
- U4 SEAT & BACK, WITH WATERLINE
- U8 TRI-COLOR - SEAT, BACK & WATERLINE

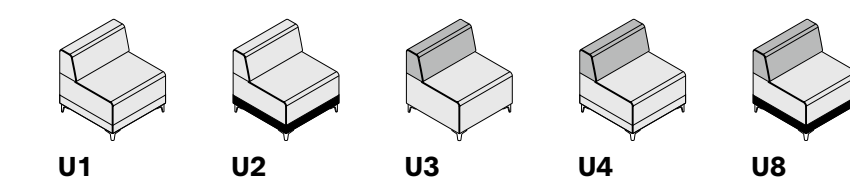

When pricing models with more than one fabric, the higher grade fabric will determine the overall grade of the specific product.

6. Upholstery

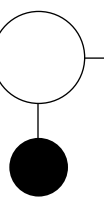

Upholstery

See [general information section](#) for details on textile program and COM/COL information.

Share will develop comfort wrinkles over time. The extent of these wrinkles is determined by the fabric specified.

Share

CHAIR: 120° CORNER, LOUNGE HEIGHT

Textile Upholstery Grades

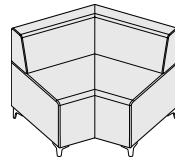
TITLE	SERIES	TYPE	SEAT	UPH	DIMENSIONS	YDG	COM	A	B	C	D	E	F	G	H	I	J	K	L	M
	Standard Upholstery	SH	12	46	42.5W x 28D x 29H	4.1	3,573	3,908	4,089	4,266	4,449	4,629	4,829	5,031	5,265	5,570	5,935	6,083	6,427	6,715
	Mono-Color Waterline	SH	12	46	42.5W x 28D x 29H	3.8	3,830	4,139	4,308	4,471	4,643	4,810	4,995	5,180	5,399	5,682	6,021	6,156	6,476	6,742
	Dual-Color Waterline	SH	12	46	42.5W x 28D x 29H	3.4 above Waterline 0.8 below Waterline	3,830	4,174	4,361	4,540	4,728	4,914	5,119	5,324	5,563	5,877	6,251	6,401	6,754	7,049
	No Waterline Back & Seat	SH	12	46	42.5W x 28D x 29H	1.7 Back 2.4 Seat	3,573	3,908	4,089	4,266	4,449	4,629	4,829	5,031	5,265	5,570	5,935	6,083	6,427	6,715
	Waterline Back & Seat	SH	12	46	42.5W x 28D x 29H	1.7 Back 2.4 Seat/below Waterline	3,830	4,139	4,308	4,471	4,643	4,810	4,995	5,180	5,399	5,682	6,021	6,340	6,684	6,972
	Triple-Back & Seat & Waterline	SH	12	46	42.5W x 28D x 29H	0.8 below Waterline 1.7 Back 1.7 Seat/above Waterline	3,830	4,174	4,361	4,540	4,728	4,914	5,119	5,324	5,563	5,877	6,251	6,401	6,754	7,049

To Order Select Below

1. Series/Type/Seat

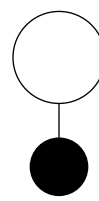

SH1246

Share
Chair, 120° Corner
Lounge Height

2. Leg

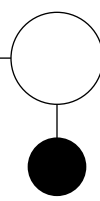

Leg

- L1 CORNER LEG, ADJ. PLASTIC GLIDES
- L2 ROUND LEG, ADJ. PLASTIC GLIDES
- L3 WOOD LEG

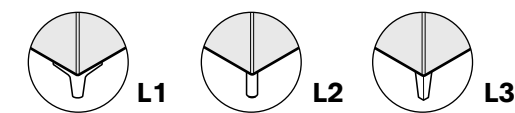

Mobility

The round leg glide has a larger diameter (1") than the corner leg for easier sliding on low pile carpet. Stylex is not responsible for damage to carpeting or floors.

3. Leg Finish

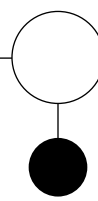

Standard Powder Coated Metal

- | | |
|--------------------|-------------------|
| BL BLUE | NK NICKEL |
| BM BLACK MATTE | NV NAVY |
| BR BRASS | OR ORANGE |
| BT BLACK TWILIGHT | PY PALE YELLOW |
| CP CHAMPAGNE | RD RED |
| DB DARK BRONZE | RO RED ORANGE |
| DG DARK GRAY | RR RUSTY RED |
| DP DUSTY PINK | SB SOFT BLUE |
| FG FOREST GREEN | SD SAND |
| LG LIGHT GRAY | TC TERRACOTTA |
| MG MEADOW GREEN | TP TAUPE |
| MK MILK | TS TEXTURED SLATE |
| MS METALLIC SILVER | YL YELLOW |

4. Options

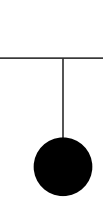

Polished Aluminum

AL POLISHED ALUMINUM

Wood Finish +215

- 81 WHITE OAK
- 83 NATURAL MAPLE
- 85 WALNUT

Custom Color Match

09 CUSTOM COLOR

Per order per color - 20 chair minimum.
Contact customer service for details.

4. Options

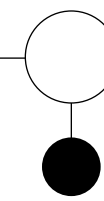

Ganging

SG GANGING **+51**

Used to connect chairs to adjacent chairs or benches.

Power

IN-SEAT POWER
C1X PORT W/10' CORD **+435**

IN-SEAT POWER
C2X PORT W/20' CORD **+466**

See [page 7](#) for power port spec info.

Power Port Finish

Power ports can be finished in any standard powder coat available.

5. Upholstery Style

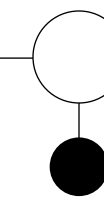

Upholstery Style

- U1 MONO-COLOR WATERLINE
- U2 DUAL-COLOR WATERLINE
- U3 SEAT & BACK, NO WATERLINE
- U4 SEAT & BACK, WITH WATERLINE
- U8 TRI-COLOR - SEAT, BACK & WATERLINE

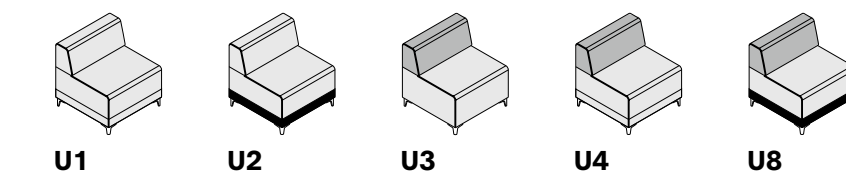

When pricing models with more than one fabric, the higher grade fabric will determine the overall grade of the specific product.

6. Upholstery

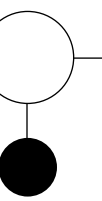

Upholstery

See [general information section](#) for details on textile program and COM/COL information.

Share will develop comfort wrinkles over time. The extent of these wrinkles is determined by the fabric specified.

Share

CHAIR: 120° CORNER, TASK HEIGHT

Textile Upholstery Grades

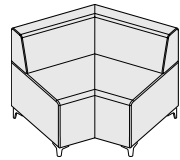
TITLE	SERIES	TYPE	SEAT	UPH	DIMENSIONS	YDG	COM	A	B	C	D	E	F	G	H	I	J	K	L	M
Chair, 120° Corner, Task Height 	Standard Upholstery	SH	12	48	42.5W x 28D x 29H	4.1	3,573	3,908	4,089	4,266	4,449	4,629	4,829	5,031	5,265	5,570	5,935	6,083	6,427	6,715
	Mono-Color Waterline	SH	12	48	42.5W x 28D x 29H	3.8	3,830	4,139	4,308	4,471	4,643	4,810	4,995	5,180	5,399	5,682	6,021	6,156	6,476	6,742
	Dual-Color Waterline	SH	12	48	42.5W x 28D x 29H	3.5 above Waterline 0.8 below Waterline	3,830	4,174	4,361	4,540	4,728	4,914	5,119	5,324	5,563	5,877	6,251	6,462	6,824	7,125
	No Waterline Back & Seat	SH	12	48	42.5W x 28D x 29H	1.6 Back 2.5 Seat	3,573	3,908	4,089	4,266	4,449	4,629	4,829	5,031	5,265	5,570	5,935	6,083	6,427	6,715
	Waterline Back & Seat	SH	12	48	42.5W x 28D x 29H	1.6 Back 2.5 Seat/below Waterline	3,830	4,139	4,308	4,471	4,643	4,810	4,995	5,180	5,399	5,682	6,021	6,340	6,684	6,972
	Triple-Back & Seat & Waterline	SH	12	48	42.5W x 28D x 29H	0.8 below Waterline 1.6 Back 1.9 Seat/above Waterline	3,830	4,174	4,361	4,540	4,728	4,914	5,119	5,324	5,563	5,877	6,251	6,462	6,824	7,125

To Order Select Below

1. Series/Type/Seat

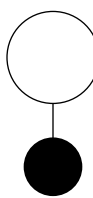

SH1248

Share
Chair, 120° Corner
Task Height

2. Leg

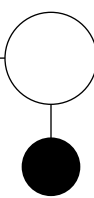

Leg

- L1 CORNER LEG, ADJ. PLASTIC GLIDES
- L2 ROUND LEG, ADJ. PLASTIC GLIDES
- L3 WOOD LEG

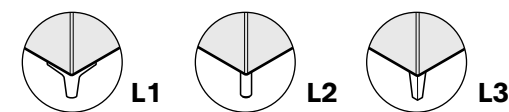

Mobility

The round leg glide has a larger diameter (1") than the corner leg for easier sliding on low pile carpet. Stylex is not responsible for damage to carpeting or floors.

3. Leg Finish

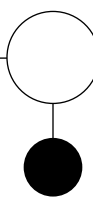

Standard Powder Coated Metal

- BL BLUE
- BM BLACK MATTE
- BR BRASS
- BT BLACK TWILIGHT
- CP CHAMPAGNE
- DB DARK BRONZE
- DG DARK GRAY
- DP DUSTY PINK
- FG FOREST GREEN
- LG LIGHT GRAY
- MG MEADOW GREEN
- MK MILK
- MS METALLIC SILVER

- NK NICKEL
- NV NAVY
- OR ORANGE
- PY PALE YELLOW
- RD RED
- RO RED ORANGE
- RR RUSTY RED
- SB SOFT BLUE
- SD SAND
- TC TERRACOTTA
- TP TAUPE
- TS TEXTURED SLATE
- YL YELLOW

4. Options

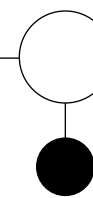

Ganging

- SG GANGING **+51**

Used to connect chairs to adjacent chairs or benches.

Power

- C1X IN-SEAT POWER PORT W/10' CORD **+435**
- C2X IN-SEAT POWER PORT W/20' CORD **+466**

See [page 7](#) for power port spec info.

Power Port Finish

Power ports can be finished in any standard powder coat available.

5. Upholstery Style

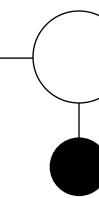

Upholstery Style

- U1 MONO-COLOR WATERLINE
- U2 DUAL-COLOR WATERLINE
- U3 SEAT & BACK, NO WATERLINE
- U4 SEAT & BACK, WITH WATERLINE
- U8 TRI-COLOR - SEAT, BACK & WATERLINE

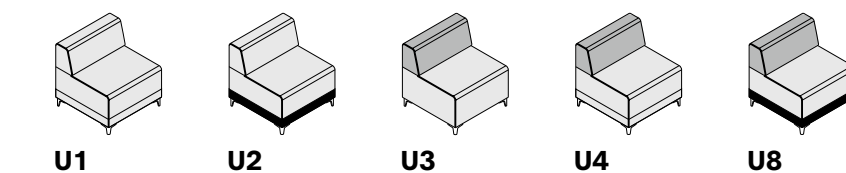

When pricing models with more than one fabric, the higher grade fabric will determine the overall grade of the specific product.

6. Upholstery

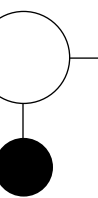

Upholstery

See [general information section](#) for details on textile program and COM/COL information.

Share will develop comfort wrinkles over time. The extent of these wrinkles is determined by the fabric specified.

Share

CHAIR: 120° CORNER, BANQUETTE HEIGHT

Textile Upholstery Grades

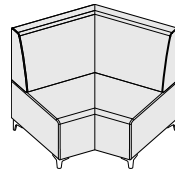
TITLE	SERIES	TYPE	SEAT	UPH	DIMENSIONS	YDG	COM	A	B	C	D	E	F	G	H	I	J	K	L	M
 Chair, 120° Corner, Banquette Height	Standard Upholstery	SH	72	48	42.5W x 28D x 36H	5	4,148	4,553	4,776	4,991	5,214	5,435	5,679	5,923	6,209	6,582	7,026	7,471	7,907	8,231
	Mono-Color Waterline	SH	72	48	42.5W x 28D x 36H	4.7	4,405	4,789	4,995	5,201	5,406	5,616	5,844	6,072	6,342	6,693	7,111	7,529	7,939	8,240
	Dual-Color Waterline	SH	72	48	42.5W x 28D x 36H	4.4 above Waterline 0.8 below Waterline	4,405	4,828	5,059	5,284	5,514	5,745	5,999	6,252	6,550	6,937	7,399	7,859	8,316	8,651
	No Waterline Back & Seat	SH	72	48	42.5W x 28D x 36H	2.5 Back 2.5 Seat	4,148	4,553	4,776	4,991	5,214	5,435	5,679	5,923	6,209	6,582	7,026	7,471	7,907	8,231
	Waterline Back & Seat	SH	72	48	42.5W x 28D x 36H	2.5 Back 2.2 Seat/below Waterline	4,405	4,789	4,995	5,201	5,406	5,616	5,844	6,072	6,342	6,693	7,111	7,529	7,939	8,240
	Triple-Back & Seat & Waterline	SH	72	48	42.5W x 28D x 36H	0.8 below Waterline 2.5 Back 1.9 Seat/above Waterline	4,405	4,828	5,059	5,284	5,514	5,745	5,999	6,252	6,550	6,937	7,399	7,859	8,316	8,651

To Order Select Below

1. Series/Type/Seat

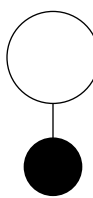

SH7248

Share
Chair, 120° Corner
Banquette Height

2. Leg

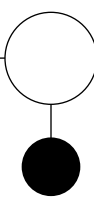

Leg

- L1 CORNER LEG, ADJ. PLASTIC GLIDES
- L2 ROUND LEG, ADJ. PLASTIC GLIDES
- L3 WOOD LEG

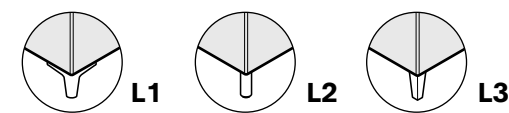

Mobility

The round leg glide has a larger diameter (1") than the corner leg for easier sliding on low pile carpet. Stylex is not responsible for damage to carpeting or floors.

3. Leg Finish

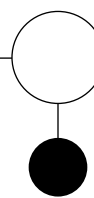

Standard Powder Coated Metal

- | | |
|--------------------|-------------------|
| BL BLUE | NK NICKEL |
| BM BLACK MATTE | NV NAVY |
| BR BRASS | OR ORANGE |
| BT BLACK TWILIGHT | PY PALE YELLOW |
| CP CHAMPAGNE | RD RED |
| DB DARK BRONZE | RO RED ORANGE |
| DG DARK GRAY | RR RUSTY RED |
| DP DUSTY PINK | SB SOFT BLUE |
| FG FOREST GREEN | SD SAND |
| LG LIGHT GRAY | TC TERRACOTTA |
| MG MEADOW GREEN | TP TAUPE |
| MK MILK | TS TEXTURED SLATE |
| MS METALLIC SILVER | YL YELLOW |

4. Options

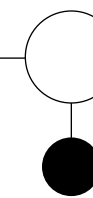

Ganging

- SG GANGING **+51**

Used to connect chairs to adjacent chairs or benches.

Power

- C1X IN-SEAT POWER PORT W/10' CORD **+435**
- C2X IN-SEAT POWER PORT W/20' CORD **+466**

See [page 7](#) for power port spec info.

Power Port Finish

Power ports can be finished in any standard powder coat available.

5. Upholstery Style

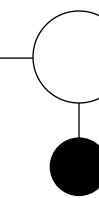

Upholstery Style

- U1 MONO-COLOR WATERLINE
- U2 DUAL-COLOR WATERLINE
- U3 SEAT & BACK, NO WATERLINE
- U4 SEAT & BACK, WITH WATERLINE
- U8 TRI-COLOR - SEAT, BACK & WATERLINE

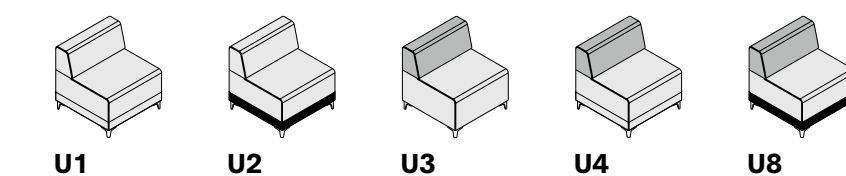

When pricing models with more than one fabric, the higher grade fabric will determine the overall grade of the specific product.

6. Upholstery

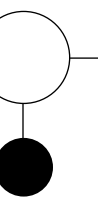

Upholstery

See general information section for details on textile program and COM/COL information.

Share will develop comfort wrinkles over time. The extent of these wrinkles is determined by the fabric specified.

Share

CHAIR: 30° INSIDE CURVED, LOUNGE HEIGHT

Textile Upholstery Grades

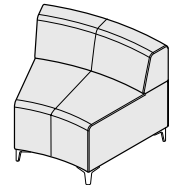
TITLE	SERIES	TYPE	SEAT	UPH	DIMENSIONS	YDG	COM	A	B	C	D	E	F	G	H	I	J	K	L	M	
 Chair, 30 Inside Curved, Lounge Height	Standard Upholstery	SH	14	56	35W x 28D x 29H	3.8	2,526	2,831	2,995	3,153	3,318	3,484	3,668	3,847	4,061	4,339	4,668	4,806	5,120	5,439	
	Mono-Color Waterline	SH	14	56	U1	35W x 28D x 29H	3.8	2,713	3,018	3,180	3,341	3,508	3,674	3,854	4,035	4,247	4,526	4,855	4,988	5,300	5,618
	Dual-Color Waterline	SH	14	56	U2	35W x 28D x 29H	3.3 above Waterline 0.8 below Waterline	2,713	3,041	3,219	3,394	3,570	3,750	3,945	4,142	4,370	4,668	5,025	5,175	5,514	5,857
	No Waterline Back & Seat	SH	14	56	U3	35W x 28D x 29H	1.4 Back 2.4 Seat	2,526	2,831	2,995	3,153	3,318	3,484	3,668	3,847	4,061	4,339	4,668	4,806	5,120	5,439
	Waterline Back & Seat	SH	14	56	U4	35W x 28D x 29H	1.2 Back 1.6 Seat/below Waterline	2,713	3,018	3,180	3,341	3,508	3,674	3,854	4,035	4,247	4,526	4,855	4,988	5,300	5,618
	Triple-Back & Seat & Waterline	SH	14	56	U8	35W x 28D x 29H	0.8 below Waterline 1.2 Back 1.6 Seat/above Waterline	2,713	3,041	3,219	3,394	3,570	3,750	3,945	4,142	4,370	4,668	5,025	5,175	5,514	5,857

To Order Select Below

1. Series/Type/Seat

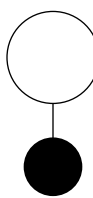

SH1456

Share
Chair, 30° Inside Curved,
Lounge Height

2. Leg

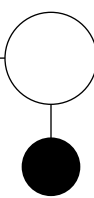

Leg

- L1 CORNER LEG, ADJ. PLASTIC GLIDES
- L2 ROUND LEG, ADJ. PLASTIC GLIDES
- L3 WOOD LEG

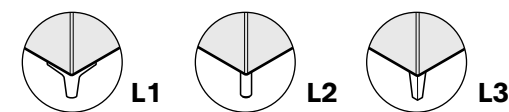

Mobility

The round leg glide has a larger diameter (1") than the corner leg for easier sliding on low pile carpet. Stylex is not responsible for damage to carpeting or floors.

3. Leg Finish

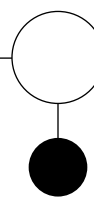

Standard Powder Coated Metal

- BL BLUE
- BM BLACK MATTE
- BR BRASS
- BT BLACK TWILIGHT
- CP CHAMPAGNE
- DB DARK BRONZE
- DG DARK GRAY
- DP DUSTY PINK
- FG FOREST GREEN
- LG LIGHT GRAY
- MG MEADOW GREEN
- MK MILK
- MS METALLIC SILVER

- NK NICKEL
- NV NAVY
- OR ORANGE
- PY PALE YELLOW
- RD RED
- RO RED ORANGE
- RR RUSTY RED
- SB SOFT BLUE
- SD SAND
- TC TERRACOTTA
- TP TAUPE
- TS TEXTURED SLATE
- YL YELLOW

4. Options

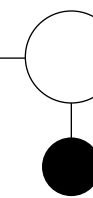

Ganging

- SG GANGING **+51**

Used to connect chairs to adjacent chairs or benches.

Power

- C1X IN-SEAT POWER PORT W/10' CORD **+435**
- C2X IN-SEAT POWER PORT W/20' CORD **+466**

See [page 7](#) for power port spec info.

Power Port Finish

Power ports can be finished in any standard powder coat available.

5. Upholstery Style

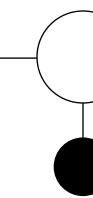

Upholstery Style

- U1 MONO-COLOR WATERLINE
- U2 DUAL-COLOR WATERLINE
- U3 SEAT & BACK, NO WATERLINE
- U4 SEAT & BACK, WITH WATERLINE
- U8 TRI-COLOR - SEAT, BACK & WATERLINE

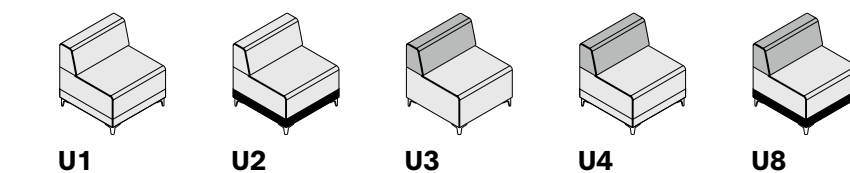

When pricing models with more than one fabric, the higher grade fabric will determine the overall grade of the specific product.

6. Upholstery

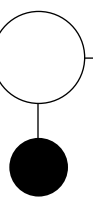

Upholstery

See [general information section](#) for details on textile program and COM/COL information.

Share will develop comfort wrinkles over time. The extent of these wrinkles is determined by the fabric specified.

Share

CHAIR: 30° INSIDE CURVED, TASK HEIGHT

Textile Upholstery Grades

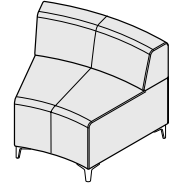
TITLE	SERIES	TYPE	SEAT	UPH	DIMENSIONS	YDG	COM	A	B	C	D	E	F	G	H	I	J	K	L	M	
Chair, 30 Inside Curved, Task Height 	Standard Upholstery	SH	14	58	35W x 28D x 29H	3.8	2,526	2,831	2,995	3,153	3,318	3,484	3,668	3,847	4,061	4,339	4,668	4,806	5,120	5,439	
	Mono-Color Waterline	SH	14	58	U1	35W x 28D x 29H	3.8	2,713	3,018	3,180	3,341	3,508	3,674	3,854	4,035	4,247	4,526	4,855	4,988	5,300	5,618
	Dual-Color Waterline	SH	14	58	U2	35W x 28D x 29H	3 above Waterline 0.8 below Waterline	2,713	3,018	3,180	3,341	3,508	3,674	3,854	4,035	4,247	4,526	4,855	4,988	5,300	5,618
	No Waterline Back & Seat	SH	14	58	U3	35W x 28D x 29H	1.4 Back 2.4 Seat	2,526	2,831	2,995	3,153	3,318	3,484	3,668	3,847	4,061	4,339	4,668	4,806	5,120	5,439
	Waterline Back & Seat	SH	14	58	U4	35W x 28D x 29H	1.1 Back 1.7 Seat/below Waterline	2,713	3,018	3,180	3,341	3,508	3,674	3,854	4,035	4,247	4,526	4,855	4,988	5,300	5,618
	Triple-Back & Seat & Waterline	SH	14	58	U8	35W x 28D x 29H	0.8 below Waterline 1.1 Back 1.7 Seat/above Waterline	2,713	3,018	3,180	3,341	3,508	3,674	3,854	4,035	4,247	4,526	4,855	4,988	5,300	5,618

To Order Select Below

1. Series/Type/Seat

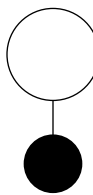

SH1458
Share
Chair, 30° Inside Curved
Task Height

2. Leg

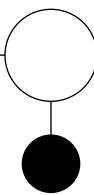

Leg

- L1 CORNER LEG, ADJ. PLASTIC GLIDES
- L2 ROUND LEG, ADJ. PLASTIC GLIDES
- L3 WOOD LEG

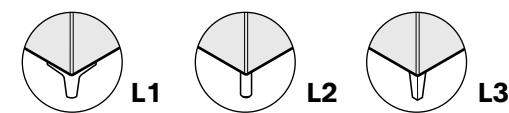

Mobility

The round leg glide has a larger diameter (1") than the corner leg for easier sliding on low pile carpet. Stylex is not responsible for damage to carpeting or floors.

3. Leg Finish

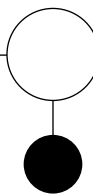

Standard Powder Coated Metal

- BL BLUE
- BM BLACK MATTE
- BR BRASS
- BT BLACK TWILIGHT
- CP CHAMPAGNE
- DB DARK BRONZE
- DG DARK GRAY
- DP DUSTY PINK
- FG FOREST GREEN
- LG LIGHT GRAY
- MG MEADOW GREEN
- MK MILK
- MS METALLIC SILVER

- NK NICKEL
- NV NAVY
- OR ORANGE
- PY PALE YELLOW
- RD RED
- RO RED ORANGE
- RR RUSTY RED
- SB SOFT BLUE
- SD SAND
- TC TERRACOTTA
- TP TAUPE
- TS TEXTURED SLATE
- YL YELLOW

4. Options

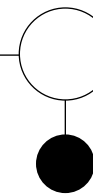

Ganging

- SG GANGING **+51**

Used to connect chairs to adjacent chairs or benches.

Power

- C1X IN-SEAT POWER PORT W/10' CORD **+435**
- C2X IN-SEAT POWER PORT W/20' CORD **+466**

See [page 7](#) for power port spec info.

Power Port Finish

Power ports can be finished in any standard powder coat available.

5. Upholstery Style

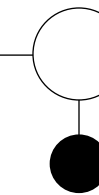

Upholstery Style

- U1 MONO-COLOR WATERLINE
- U2 DUAL-COLOR WATERLINE
- U3 SEAT & BACK, NO WATERLINE
- U4 SEAT & BACK, WITH WATERLINE
- U8 TRI-COLOR - SEAT, BACK & WATERLINE

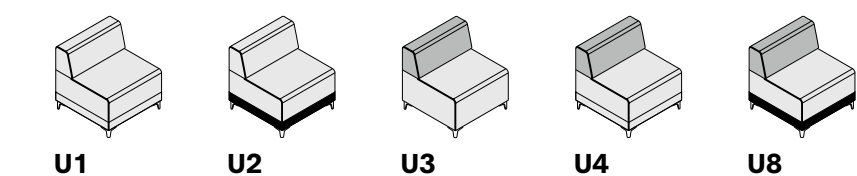

When pricing models with more than one fabric, the higher grade fabric will determine the overall grade of the specific product.

6. Upholstery

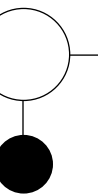

Upholstery

See [general information section](#) for details on textile program and COM/COL information.

Share will develop comfort wrinkles over time. The extent of these wrinkles is determined by the fabric specified.

Share

CHAIR: 30° OUTSIDE CURVED, LOUNGE HEIGHT

Textile Upholstery Grades

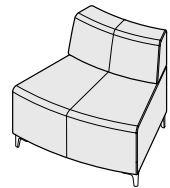
TITLE	SERIES	TYPE	SEAT	UPH	DIMENSIONS	YDG	COM	A	B	C	D	E	F	G	H	I	J	K	L	M	
 Chair, 30 Outside Curved, Lounge Height	Standard Upholstery	SH	15	56	35W x 28D x 29H	3.2	2,526	2,780	2,920	3,056	3,196	3,335	3,486	3,639	3,819	4,052	4,330	4,431	4,696	4,962	
	Mono-Color Waterline	SH	15	56	U1	35W x 28D x 29H	3.2	2,713	2,968	3,109	3,245	3,383	3,522	3,675	3,826	4,008	4,240	4,517	4,613	4,876	5,143
	Dual-Color Waterline	SH	15	56	U2	35W x 28D x 29H	2.7 above Waterline 0.8 below Waterline	2,713	2,995	3,145	3,293	3,445	3,598	3,764	3,931	4,128	4,382	4,687	4,801	5,089	5,381
	No Waterline Back & Seat	SH	15	56	U3	35W x 28D x 29H	1.54 Back 2.2 Seat	2,526	2,780	2,920	3,056	3,196	3,335	3,486	3,639	3,819	4,052	4,330	4,431	4,696	4,962
	Waterline Back & Seat	SH	15	56	U4	35W x 28D x 29H	1.4 Back 1.9 Seat/below Waterline	2,713	2,968	3,109	3,245	3,383	3,522	3,675	3,826	4,008	4,240	4,517	4,613	4,876	5,143
	Triple-Back & Seat & Waterline	SH	15	56	U8	35W x 28D x 29H	0.8 below Waterline 1.4 Back 1.9 Seat/above Waterline	2,713	2,995	3,145	3,293	3,445	3,598	3,764	3,931	4,128	4,382	4,687	4,801	5,089	5,381

To Order Select Below

1. Series/Type/Seat

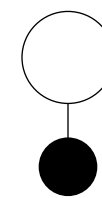

SH1556

Share
Chair, 30° Outside Curved,
Lounge Height

2. Leg

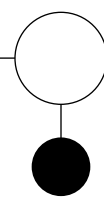

Leg

- L1 CORNER LEG, ADJ. PLASTIC GLIDES
- L2 ROUND LEG, ADJ. PLASTIC GLIDES
- L3 WOOD LEG

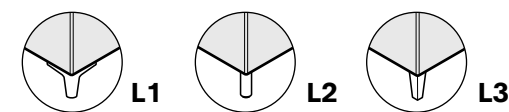

Mobility

The round leg glide has a larger diameter (1") than the corner leg for easier sliding on low pile carpet. Stylex is not responsible for damage to carpeting or floors.

3. Leg Finish

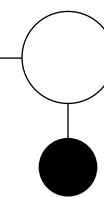

Standard Powder Coated Metal

- | | |
|--------------------|-------------------|
| BL BLUE | NK NICKEL |
| BM BLACK MATTE | NV NAVY |
| BR BRASS | OR ORANGE |
| BT BLACK TWILIGHT | PY PALE YELLOW |
| CP CHAMPAGNE | RD RED |
| DB DARK BRONZE | RO RED ORANGE |
| DG DARK GRAY | RR RUSTY RED |
| DP DUSTY PINK | SB SOFT BLUE |
| FG FOREST GREEN | SD SAND |
| LG LIGHT GRAY | TC TERRACOTTA |
| MG MEADOW GREEN | TP TAUPE |
| MK MILK | TS TEXTURED SLATE |
| MS METALLIC SILVER | YL YELLOW |

4. Options

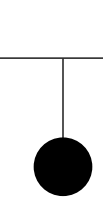

Polished Aluminum

AL POLISHED ALUMINUM

Wood Finish +215

- 81 WHITE OAK
- 83 NATURAL MAPLE
- 85 WALNUT

Custom Color Match

09 CUSTOM COLOR

Per order per color - 20 chair minimum.
Contact customer service for details.

5. Upholstery Style

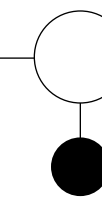

Ganging

SG GANGING **+51**

Used to connect chairs to adjacent chairs or benches.

Power

IN-SEAT POWER
C1X PORT W/10' CORD **+435**

IN-SEAT POWER
C2X PORT W/20' CORD **+466**

See [page 7](#) for power port spec info.

Power Port Finish

Power ports can be finished in any standard powder coat available.

6. Upholstery

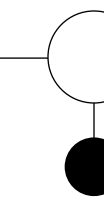

Upholstery Style

- U1 MONO-COLOR WATERLINE
- U2 DUAL-COLOR WATERLINE
- U3 SEAT & BACK, NO WATERLINE
- U4 SEAT & BACK, WITH WATERLINE
- U8 TRI-COLOR - SEAT, BACK & WATERLINE

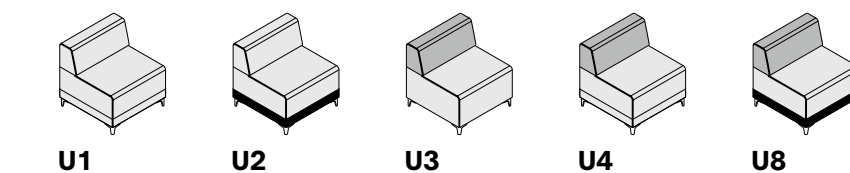

When pricing models with more than one fabric, the higher grade fabric will determine the overall grade of the specific product.

Upholstery

See [general information section](#) for details on textile program and COM/COL information.

Share will develop comfort wrinkles over time. The extent of these wrinkles is determined by the fabric specified.

Share

CHAIR: 30° OUTSIDE CURVED, TASK HEIGHT

Textile Upholstery Grades

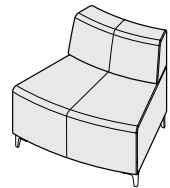
TITLE	SERIES	TYPE	SEAT	UPH	DIMENSIONS	YDG	COM	A	B	C	D	E	F	G	H	I	J	K	L	M	
 Chair, 30° Outside Curved, Task Height	Standard Upholstery	SH	15	58	35W x 28D x 29H	3.3	2,526	2,788	2,933	3,071	3,215	3,359	3,514	3,674	3,860	4,100	4,386	4,494	4,767	5,042	
	Mono-Color Waterline	SH	15	58	U1	35W x 28D x 29H	3.3	2,713	2,978	3,120	3,259	3,403	3,546	3,704	3,862	4,045	4,287	4,575	4,675	4,947	5,223
	Dual-Color Waterline	SH	15	58	U2	35W x 28D x 29H	2.5 above Waterline 0.8 below Waterline	2,713	2,978	3,120	3,259	3,403	3,546	3,704	3,862	4,045	4,287	4,575	4,675	4,947	5,223
	No Waterline Back & Seat	SH	15	58	U3	35W x 28D x 29H	1.54 Back 2.2 Seat	2,526	2,788	2,933	3,071	3,215	3,359	3,514	3,674	3,860	4,100	4,386	4,494	4,767	5,042
	Waterline Back & Seat	SH	15	58	U4	35W x 28D x 29H	1.4 Back 1.8 Seat/below Waterline	2,713	2,978	3,120	3,259	3,403	3,546	3,704	3,862	4,045	4,287	4,575	4,675	4,947	5,223
	Triple-Back & Seat & Waterline	SH	15	58	U8	35W x 28D x 29H	0.8 below Waterline 1.4 Back 1.8 Seat/above Waterline	2,713	2,978	3,120	3,259	3,403	3,546	3,704	3,862	4,045	4,287	4,575	4,675	4,947	5,223

To Order Select Below

1. Series/Type/Seat

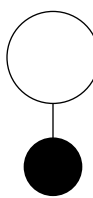

SH1558

Share
Chair, 30° Outside Curved,
Task Height

2. Leg

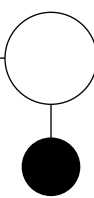

Leg

- L1 CORNER LEG, ADJ. PLASTIC GLIDES
- L2 ROUND LEG, ADJ. PLASTIC GLIDES
- L3 WOOD LEG

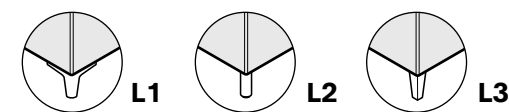

Mobility

The round leg glide has a larger diameter (1") than the corner leg for easier sliding on low pile carpet. Stylex is not responsible for damage to carpeting or floors.

3. Leg Finish

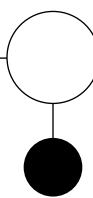

Standard Powder Coated Metal

- BL BLUE
- BM BLACK MATTE
- BR BRASS
- BT BLACK TWILIGHT
- CP CHAMPAGNE
- DB DARK BRONZE
- DG DARK GRAY
- DP DUSTY PINK
- FG FOREST GREEN
- LG LIGHT GRAY
- MG MEADOW GREEN
- MK MILK
- MS METALLIC SILVER

- NK NICKEL
- NV NAVY
- OR ORANGE
- PY PALE YELLOW
- RD RED
- RO RED ORANGE
- RR RUSTY RED
- SB SOFT BLUE
- SD SAND
- TC TERRACOTTA
- TP TAUPE
- TS TEXTURED SLATE
- YL YELLOW

4. Options

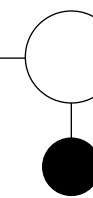

Ganging

- SG GANGING **+51**

Used to connect chairs to adjacent chairs or benches.

Power

- C1X IN-SEAT POWER PORT W/10' CORD **+435**
- C2X IN-SEAT POWER PORT W/20' CORD **+466**

See [page 7](#) for power port spec info.

Power Port Finish

Power ports can be finished in any standard powder coat available.

5. Upholstery Style

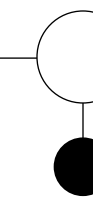

Upholstery Style

- U1 MONO-COLOR WATERLINE
- U2 DUAL-COLOR WATERLINE
- U3 SEAT & BACK, NO WATERLINE
- U4 SEAT & BACK, WITH WATERLINE
- U8 TRI-COLOR - SEAT, BACK & WATERLINE

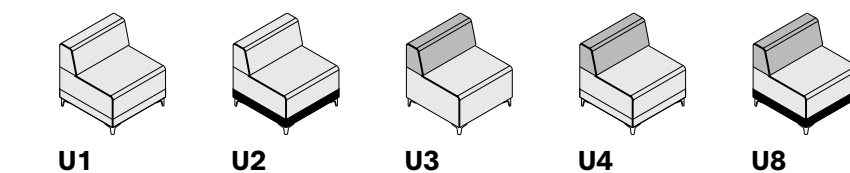

When pricing models with more than one fabric, the higher grade fabric will determine the overall grade of the specific product.

6. Upholstery

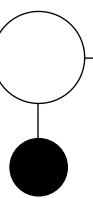

Upholstery

See [general information section](#) for details on textile program and COM/COL information.

Share will develop comfort wrinkles over time. The extent of these wrinkles is determined by the fabric specified.

Share

CHAIR: 60° INSIDE CURVED, LOUNGE HEIGHT

Textile Upholstery Grades

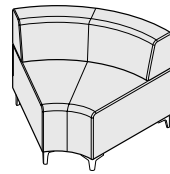
TITLE	SERIES	TYPE	SEAT	UPH	DIMENSIONS	YDG	COM	A	B	C	D	E	F	G	H	I	J	K	L	M	
 Chair, 60° Inside Curved, Lounge Height	Standard Upholstery	SH	14	66	39.75W x 28D x 29H	3.7	2,666	2,995	3,172	3,344	3,523	3,700	3,897	4,095	4,322	4,621	4,977	5,129	5,469	5,811	
	Mono-Color Waterline	SH	14	66	U1	39.75W x 28D x 29H	3.7	2,854	3,180	3,361	3,534	3,711	3,889	4,085	4,282	4,511	4,808	5,166	5,311	5,648	5,991
	Dual-Color Waterline	SH	14	66	U2	39.75W x 28D x 29H	3.5 above Waterline 0.8 below Waterline	2,854	3,198	3,384	3,566	3,754	3,940	4,145	4,350	4,590	4,907	5,279	5,436	5,790	6,149
	No Waterline Back & Seat	SH	14	66	U3	39.75W x 28D x 29H	1.5 Back 2.6 Seat	2,666	2,995	3,172	3,344	3,523	3,700	3,897	4,095	4,322	4,621	4,977	5,129	5,469	5,811
	Waterline Back & Seat	SH	14	66	U4	39.75W x 28D x 29H	1.1 Back 1.4 Seat/below Waterline	2,854	3,180	3,361	3,534	3,711	3,889	4,085	4,282	4,511	4,808	5,166	5,311	5,648	5,991
	Triple-Back & Seat & Waterline	SH	14	66	U8	39.75W x 28D x 29H	0.8 below Waterline 1.1 Back 1.4 Seat/above Waterline	2,854	3,198	3,384	3,566	3,754	3,940	4,145	4,350	4,590	4,907	5,279	5,436	5,790	6,149

To Order Select Below

1. Series/Type/Seat

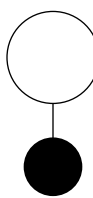

SH1466

Share
Chair, 60° Inside Curved,
Lounge Height

2. Leg

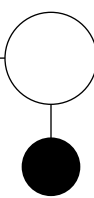

Leg

- L1 CORNER LEG, ADJ. PLASTIC GLIDES
- L2 ROUND LEG, ADJ. PLASTIC GLIDES
- L3 WOOD LEG

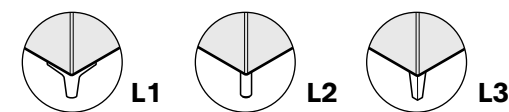

Mobility

The round leg glide has a larger diameter (1") than the corner leg for easier sliding on low pile carpet. Stylex is not responsible for damage to carpeting or floors.

3. Leg Finish

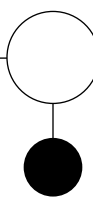

Standard Powder Coated Metal

- BL BLUE
- BM BLACK MATTE
- BR BRASS
- BT BLACK TWILIGHT
- CP CHAMPAGNE
- DB DARK BRONZE
- DG DARK GRAY
- DP DUSTY PINK
- FG FOREST GREEN
- LG LIGHT GRAY
- MG MEADOW GREEN
- MK MILK
- MS METALLIC SILVER

- NK NICKEL
- NV NAVY
- OR ORANGE
- PY PALE YELLOW
- RD RED
- RO RED ORANGE
- RR RUSTY RED
- SB SOFT BLUE
- SD SAND
- TC TERRACOTTA
- TP TAUPE
- TS TEXTURED SLATE
- YL YELLOW

4. Options

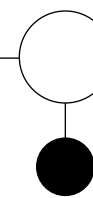

Ganging

- SG GANGING **+51**

Used to connect chairs to adjacent chairs or benches.

Power

- C1X IN-SEAT POWER PORT W/10' CORD **+435**
- C2X IN-SEAT POWER PORT W/20' CORD **+466**

See [page 7](#) for power port spec info.

Power Port Finish

Power ports can be finished in any standard powder coat available.

5. Upholstery Style

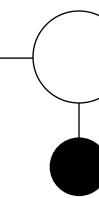

Upholstery Style

- U1 MONO-COLOR WATERLINE
- U2 DUAL-COLOR WATERLINE
- U3 SEAT & BACK, NO WATERLINE
- U4 SEAT & BACK, WITH WATERLINE
- U8 TRI-COLOR - SEAT, BACK & WATERLINE

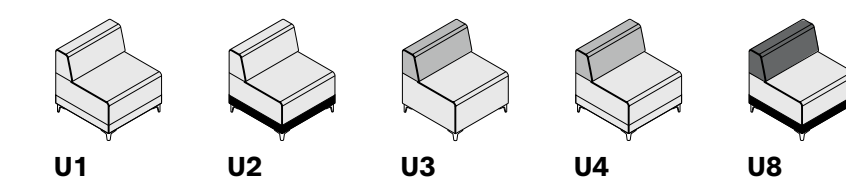

When pricing models with more than one fabric, the higher grade fabric will determine the overall grade of the specific product.

6. Upholstery

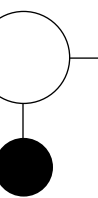

Upholstery

See [general information section](#) for details on textile program and COM/COL information.

Share will develop comfort wrinkles over time. The extent of these wrinkles is determined by the fabric specified.

Share

CHAIR: 60° INSIDE CURVED, TASK HEIGHT

Textile Upholstery Grades

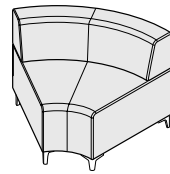
TITLE	SERIES	TYPE	SEAT	UPH	DIMENSIONS	YDG	COM	A	B	C	D	E	F	G	H	I	J	K	L	M	
Chair, 60 Inside Curved, Task Height 	Standard Upholstery	SH	14	68	39.75W x 28D x 29H	4.1	2,666	2,963	3,122	3,279	3,440	3,600	3,777	3,953	4,161	4,431	4,751	4,880	5,184	5,494	
	Mono-Color Waterline	SH	14	68	U1	39.75W x 28D x 29H	4.1	2,854	3,150	3,311	3,467	3,628	3,787	3,965	4,143	4,350	4,619	4,940	5,061	5,366	5,673
	Dual-Color Waterline	SH	14	68	U2	39.75W x 28D x 29H	3.8 above Waterline 0.8 below Waterline	2,854	3,221	3,421	3,615	3,815	4,016	4,236	4,455	4,712	5,048	5,447	5,847	6,241	6,642
	No Waterline Back & Seat	SH	14	68	U3	39.75W x 28D x 29H	1.3 Back 2.5 Seat	2,666	2,963	3,122	3,279	3,440	3,600	3,777	3,953	4,161	4,431	4,751	4,880	5,184	5,494
	Waterline Back & Seat	SH	14	68	U4	39.75W x 28D x 29H	1 Back 2 Seat/below Waterline	2,854	3,150	3,311	3,467	3,628	3,787	3,965	4,143	4,350	4,619	4,940	5,061	5,366	5,673
	Triple-Back & Seat & Waterline	SH	14	68	U8	39.75W x 28D x 29H	0.8 below Waterline 1 Back 2 Seat/above Waterline	2,854	3,221	3,421	3,615	3,815	4,016	4,236	4,455	4,712	5,048	5,447	5,847	6,241	6,642

To Order Select Below

1. Series/Type/Seat



SH1468
Share
Chair, 60° Inside Curved
Task Height

2. Leg

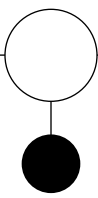

Leg

L1 CORNER LEG, ADJ. PLASTIC GLIDES
 L2 ROUND LEG, ADJ. PLASTIC GLIDES
 L3 WOOD LEG

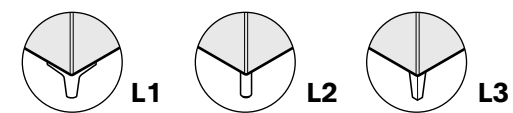

Mobility

The round leg glide has a larger diameter (1") than the corner leg for easier sliding on low pile carpet. Stylex is not responsible for damage to carpeting or floors.

3. Leg Finish

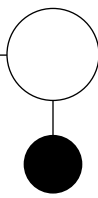

Standard Powder Coated Metal

BL BLUE
 BM BLACK MATTE
 BR BRASS
 BT BLACK TWILIGHT
 CP CHAMPAGNE
 DB DARK BRONZE
 DG DARK GRAY
 DP DUSTY PINK
 FG FOREST GREEN
 LG LIGHT GRAY
 MG MEADOW GREEN
 MK MILK
 MS METALLIC SILVER

NK NICKEL
 NV NAVY
 OR ORANGE
 PY PALE YELLOW
 RD RED
 RO RED ORANGE
 RR RUSTY RED
 SB SOFT BLUE
 SD SAND
 TC TERRACOTTA
 TP TAUPE
 TS TEXTURED SLATE
 YL YELLOW

4. Options

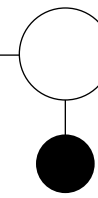

Ganging

SG GANGING **+51**

Used to connect chairs to adjacent chairs or benches.

Power

IN-SEAT POWER
 C1X PORT W/10' CORD **+435**

IN-SEAT POWER
 C2X PORT W/20' CORD **+466**

See [page 7](#) for power port spec info.

Power Port Finish

Power ports can be finished in any standard powder coat available.

5. Upholstery Style

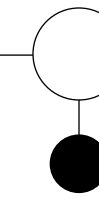

Upholstery Style

U1 MONO-COLOR WATERLINE
 U2 DUAL-COLOR WATERLINE
 U3 SEAT & BACK, NO WATERLINE
 U4 SEAT & BACK, WITH WATERLINE
 U8 TRI-COLOR - SEAT, BACK & WATERLINE

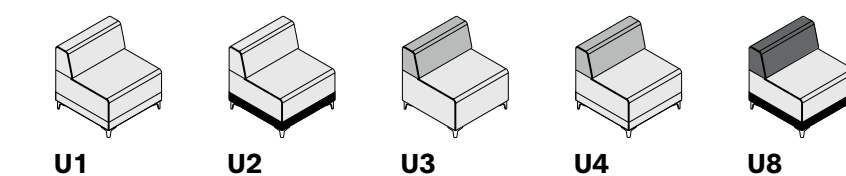

When pricing models with more than one fabric, the higher grade fabric will determine the overall grade of the specific product.

6. Upholstery

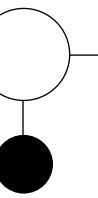

Upholstery

See [general information section](#) for details on textile program and COM/COL information.

Share will develop comfort wrinkles over time. The extent of these wrinkles is determined by the fabric specified.

Share

CHAIR: 60° OUTSIDE CURVED, LOUNGE HEIGHT

Textile Upholstery Grades

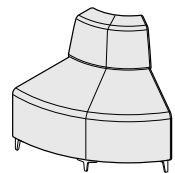
TITLE	SERIES	TYPE	SEAT	UPH	DIMENSIONS	YDG	COM	A	B	C	D	E	F	G	H	I	J	K	L	M	
Chair, 60° Outside Curved, Lounge Height 	Standard Upholstery	SH	15	66	39.75W x 28D x 29H	3.2	2,666	2,920	3,061	3,197	3,336	3,474	3,628	3,779	3,960	4,192	4,470	4,749	5,022	5,301	
	Mono-Color Waterline	SH	15	66	U1	39.75W x 28D x 29H	3.2	2,854	3,109	3,249	3,384	3,523	3,663	3,815	3,968	4,148	4,380	4,658	4,938	5,211	5,488
	Dual-Color Waterline	SH	15	66	U2	39.75W x 28D x 29H	2.4 above Waterline 0.8 below Waterline	2,854	3,109	3,249	3,384	3,523	3,663	3,815	3,968	4,148	4,380	4,658	4,938	5,211	5,488
	No Waterline Back & Seat	SH	15	66	U3	39.75W x 28D x 29H	1.65 Back 2.75 Seat	2,666	2,920	3,061	3,197	3,336	3,474	3,628	3,779	3,960	4,192	4,470	4,749	5,022	5,301
	Waterline Back & Seat	SH	15	66	U4	39.75W x 28D x 29H	1.5 Back 2 Seat/below Waterline	2,854	3,109	3,249	3,384	3,523	3,663	3,815	3,968	4,148	4,380	4,658	4,938	5,211	5,488
	Triple-Back & Seat & Waterline	SH	15	66	U8	39.75W x 28D x 29H	0.8 below Waterline 1.5 Back 2 Seat/above Waterline	2,854	3,109	3,249	3,384	3,523	3,663	3,815	3,968	4,148	4,380	4,658	4,938	5,211	5,488

To Order Select Below

1. Series/Type/Seat

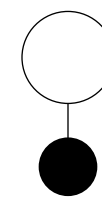

SH1566

Share
Chair, 60° Outside Curved, Lounge Height

2. Leg

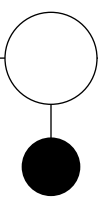

Leg

- L1 CORNER LEG, ADJ. PLASTIC GLIDES
- L2 ROUND LEG, ADJ. PLASTIC GLIDES
- L3 WOOD LEG

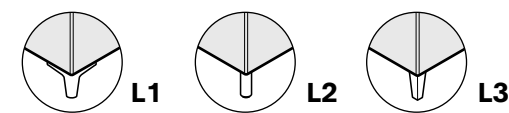

Mobility

The round leg glide has a larger diameter (1") than the corner leg for easier sliding on low pile carpet. Stylex is not responsible for damage to carpeting or floors.

3. Leg Finish

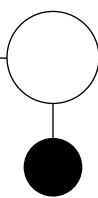

Standard Powder Coated Metal

- BL BLUE
- BM BLACK MATTE
- BR BRASS
- BT BLACK TWILIGHT
- CP CHAMPAGNE
- DB DARK BRONZE
- DG DARK GRAY
- DP DUSTY PINK
- FG FOREST GREEN
- LG LIGHT GRAY
- MG MEADOW GREEN
- MK MILK
- MS METALLIC SILVER

- NK NICKEL
- NV NAVY
- OR ORANGE
- PY PALE YELLOW
- RD RED
- RO RED ORANGE
- RR RUSTY RED
- SB SOFT BLUE
- SD SAND
- TC TERRACOTTA
- TP TAUPE
- TS TEXTURED SLATE
- YL YELLOW

4. Options

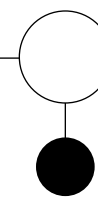

Ganging

- SG GANGING **+51**

Used to connect chairs to adjacent chairs or benches.

Power

- C1X IN-SEAT POWER PORT W/10' CORD **+435**
- C2X IN-SEAT POWER PORT W/20' CORD **+466**

See [page 7](#) for power port spec info.

Power Port Finish

Power ports can be finished in any standard powder coat available.

5. Upholstery Style

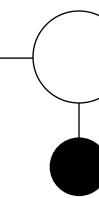

Upholstery Style

- U1 MONO-COLOR WATERLINE
- U2 DUAL-COLOR WATERLINE
- U3 SEAT & BACK, NO WATERLINE
- U4 SEAT & BACK, WITH WATERLINE
- U8 TRI-COLOR - SEAT, BACK & WATERLINE

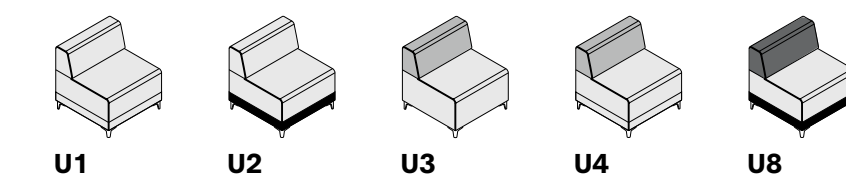

When pricing models with more than one fabric, the higher grade fabric will determine the overall grade of the specific product.

6. Upholstery

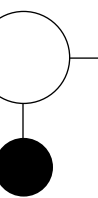

Upholstery

See [general information section](#) for details on textile program and COM/COL information.

Share will develop comfort wrinkles over time. The extent of these wrinkles is determined by the fabric specified.

Share

CHAIR: 60° OUTSIDE CURVED, TASK HEIGHT

Textile Upholstery Grades

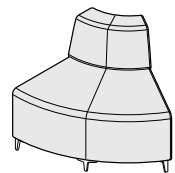
TITLE	SERIES	TYPE	SEAT	UPH	DIMENSIONS	YDG	COM	A	B	C	D	E	F	G	H	I	J	K	L	M	
Chair, 60° Outside Curved, Task Height 	Standard Upholstery	SH	15	68	39.75W x 28D x 29H	3.2	2,666	2,920	3,061	3,197	3,336	3,474	3,628	3,779	3,960	4,192	4,470	4,749	5,022	5,301	
	Mono-Color Waterline	SH	15	68	U1	39.75W x 28D x 29H	3.2	2,854	3,109	3,249	3,384	3,523	3,663	3,815	3,968	4,148	4,380	4,658	4,938	5,211	5,488
	Dual-Color Waterline	SH	15	68	U2	39.75W x 28D x 29H	2.8 above Waterline 0.8 below Waterline	2,854	3,141	3,300	3,450	3,606	3,763	3,934	4,107	4,309	4,572	4,884	5,196	5,506	5,818
	No Waterline Back & Seat	SH	15	68	U3	39.75W x 28D x 29H	1.54 Back 2.75 Seat	2,666	2,920	3,061	3,197	3,336	3,474	3,628	3,779	3,960	4,192	4,470	4,749	5,022	5,301
	Waterline Back & Seat	SH	15	68	U4	39.75W x 28D x 29H	1.4 Back 2.5 Seat/below Waterline	2,854	3,109	3,249	3,384	3,523	3,663	3,815	3,968	4,148	4,380	4,658	4,938	5,211	5,488
	Triple-Back & Seat & Waterline	SH	15	68	U8	39.75W x 28D x 29H	0.8 below Waterline 1.4 Back 2.5 Seat/above Waterline	2,854	3,141	3,300	3,450	3,606	3,763	3,934	4,107	4,309	4,572	4,884	5,196	5,506	5,818

To Order Select Below

1. Series/Type/Seat

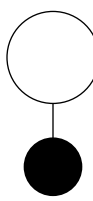

SH1568

Share
Chair, 60° Outside Curved,
Task Height

2. Leg

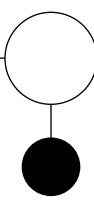

Leg

- L1 CORNER LEG, ADJ. PLASTIC GLIDES
- L2 ROUND LEG, ADJ. PLASTIC GLIDES
- L3 WOOD LEG

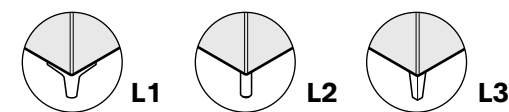

Mobility

The round leg glide has a larger diameter (1") than the corner leg for easier sliding on low pile carpet. Stylex is not responsible for damage to carpeting or floors.

3. Leg Finish

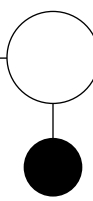

Standard Powder Coated Metal

- BL BLUE
- BM BLACK MATTE
- BR BRASS
- BT BLACK TWILIGHT
- CP CHAMPAGNE
- DB DARK BRONZE
- DG DARK GRAY
- DP DUSTY PINK
- FG FOREST GREEN
- LG LIGHT GRAY
- MG MEADOW GREEN
- MK MILK
- MS METALLIC SILVER

- NK NICKEL
- NV NAVY
- OR ORANGE
- PY PALE YELLOW
- RD RED
- RO RED ORANGE
- RR RUSTY RED
- SB SOFT BLUE
- SD SAND
- TC TERRACOTTA
- TP TAUPE
- TS TEXTURED SLATE
- YL YELLOW

4. Options

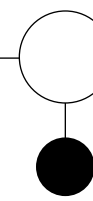

Ganging

- SG GANGING **+51**

Used to connect chairs to adjacent chairs or benches.

Power

- IN-SEAT POWER
C1X PORT W/10' CORD **+435**
- IN-SEAT POWER
C2X PORT W/20' CORD **+466**

See [page 7](#) for power port spec info.

Power Port Finish

Power ports can be finished in any standard powder coat available.

5. Upholstery Style

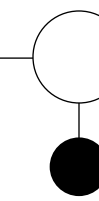

Upholstery Style

- U1 MONO-COLOR WATERLINE
- U2 DUAL-COLOR WATERLINE
- U3 SEAT & BACK, NO WATERLINE
- U4 SEAT & BACK, WITH WATERLINE
- U8 TRI-COLOR - SEAT, BACK & WATERLINE

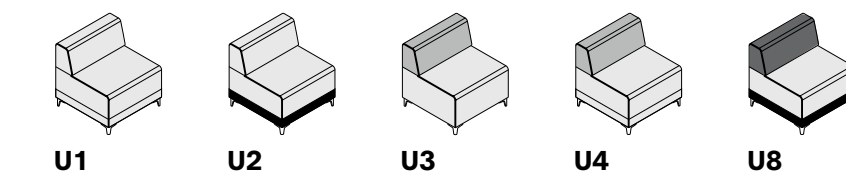

When pricing models with more than one fabric, the higher grade fabric will determine the overall grade of the specific product.

6. Upholstery

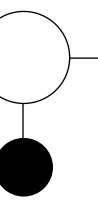

Upholstery

See [general information section](#) for details on textile program and COM/COL information.

Share will develop comfort wrinkles over time. The extent of these wrinkles is determined by the fabric specified.

Share

CHAIR: 90° INSIDE CURVED, LOUNGE HEIGHT

Textile Upholstery Grades

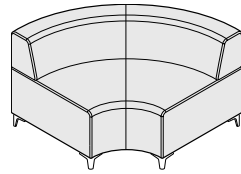
TITLE	SERIES	TYPE	SEAT	UPH	DIMENSIONS	YDG	COM	A	B	C	D	E	F	G	H	I	J	K	L	M
Chair, 90° Inside Curved, Lounge Height 	Standard Upholstery	SH	14	76	56.25W x 28D x 29H	5.6	3,508	3,954	4,200	4,435	4,678	4,921	5,188	5,455	5,772	6,178	6,668	6,879	7,338	7,807
	Mono-Color Waterline	SH	14	76	56.25W x 28D x 29H	5.6	3,696	4,144	4,386	4,622	4,866	5,109	5,378	5,645	5,958	6,367	6,853	7,059	7,520	7,988
	Dual-Color Waterline	SH	14	76	56.25W x 28D x 29H	5.3 above Waterline 0.8 below Waterline	3,696	4,183	4,449	4,707	4,971	5,236	5,525	5,818	6,160	6,606	7,137	7,371	7,875	8,385
	No Waterline Back & Seat	SH	14	76	56.25W x 28D x 29H	2.1 Back 3.5 Seat	3,508	3,954	4,200	4,435	4,678	4,921	5,188	5,455	5,772	6,178	6,668	6,879	7,338	7,807
	Waterline Back & Seat	SH	14	76	56.25W x 28D x 29H	1.5 Back 2.3 Seat/below Waterline	3,696	4,144	4,386	4,622	4,866	5,109	5,378	5,645	5,958	6,367	6,853	7,059	7,520	7,988
	Triple-Back & Seat & Waterline	SH	14	76	56.25W x 28D x 29H	1 below Waterline 1.5 Back 2.3 Seat/above Waterline	3,696	4,183	4,449	4,707	4,971	5,236	5,525	5,818	6,160	6,606	7,137	7,371	7,875	8,385

To Order Select Below

1. Series/Type/Seat

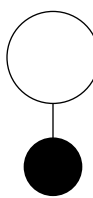

SH1476

Share
Chair, 90° Inside Curved,
Lounge Height

2. Leg

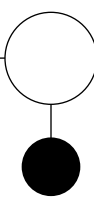

Leg

- L1 CORNER LEG, ADJ. PLASTIC GLIDES
- L2 ROUND LEG, ADJ. PLASTIC GLIDES
- L3 WOOD LEG

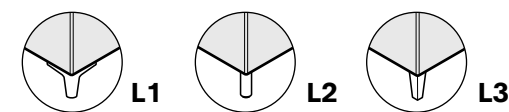

Mobility

The round leg glide has a larger diameter (1") than the corner leg for easier sliding on low pile carpet. Stylex is not responsible for damage to carpeting or floors.

3. Leg Finish

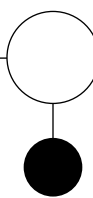

Standard Powder Coated Metal

- BL BLUE
- BM BLACK MATTE
- BR BRASS
- BT BLACK TWILIGHT
- CP CHAMPAGNE
- DB DARK BRONZE
- DG DARK GRAY
- DP DUSTY PINK
- FG FOREST GREEN
- LG LIGHT GRAY
- MG MEADOW GREEN
- MK MILK
- MS METALLIC SILVER

- NK NICKEL
- NV NAVY
- OR ORANGE
- PY PALE YELLOW
- RD RED
- RO RED ORANGE
- RR RUSTY RED
- SB SOFT BLUE
- SD SAND
- TC TERRACOTTA
- TP TAUPE
- TS TEXTURED SLATE
- YL YELLOW

4. Options

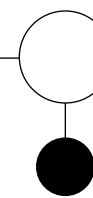

Ganging

- SG GANGING **+51**

Used to connect chairs to adjacent chairs or benches.

Power

- C1X IN-SEAT POWER PORT W/10' CORD **+435**
- C2X IN-SEAT POWER PORT W/20' CORD **+466**

See [page 7](#) for power port spec info.

Power Port Finish

Power ports can be finished in any standard powder coat available.

5. Upholstery Style

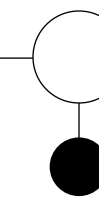

Upholstery Style

- U1 MONO-COLOR WATERLINE
- U2 DUAL-COLOR WATERLINE
- U3 SEAT & BACK, NO WATERLINE
- U4 SEAT & BACK, WITH WATERLINE
- U8 TRI-COLOR - SEAT, BACK & WATERLINE

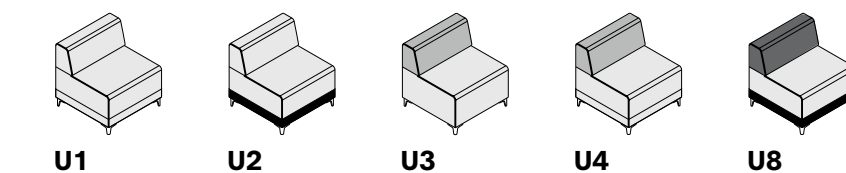

When pricing models with more than one fabric, the higher grade fabric will determine the overall grade of the specific product.

6. Upholstery

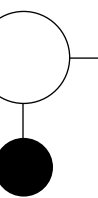

Upholstery

See [general information section](#) for details on textile program and COM/COL information.

Share will develop comfort wrinkles over time. The extent of these wrinkles is determined by the fabric specified.

Share

CHAIR: 90° INSIDE CURVED, TASK HEIGHT

Textile Upholstery Grades

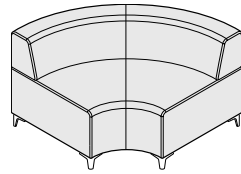
TITLE	SERIES	TYPE	SEAT	UPH	DIMENSIONS	YDG	COM	A	B	C	D	E	F	G	H	I	J	K	L	M	
Chair, 90° Inside Curved, Task Height 	Standard Upholstery	SH	14	78		56.25W x 28D x 29H	5.6	3,508	3,954	4,200	4,435	4,678	4,921	5,188	5,455	5,772	6,178	6,668	6,879	7,338	7,807
	Mono-Color Waterline	SH	14	78	U1	56.25W x 28D x 29H	5.6	3,696	4,144	4,386	4,622	4,866	5,109	5,378	5,645	5,958	6,367	6,853	7,059	7,520	7,988
	Dual-Color Waterline	SH	14	78	U2	56.25W x 28D x 29H	4.8 above Waterline 0.9 below Waterline	3,696	4,151	4,401	4,640	4,886	5,136	5,408	5,679	6,001	6,414	6,909	7,122	7,590	8,066
	No Waterline Back & Seat	SH	14	78	U3	56.25W x 28D x 29H	1.8 Back 3.5 Seat	3,508	3,954	4,200	4,435	4,678	4,921	5,188	5,455	5,772	6,178	6,668	6,879	7,338	7,807
	Waterline Back & Seat	SH	14	78	U4	56.25W x 28D x 29H	1.3 Back 2.4 Seat/below Waterline	3,696	4,144	4,386	4,622	4,866	5,109	5,378	5,645	5,958	6,367	6,853	7,059	7,520	7,988
	Triple-Back & Seat & Waterline	SH	14	78	U8	56.25W x 28D x 29H	1 below Waterline 1.3 Back 2.4 Seat/above Waterline	3,696	4,151	4,401	4,640	4,886	5,136	5,408	5,679	6,001	6,414	6,909	7,122	7,590	8,066

To Order Select Below

1. Series/Type/Seat



SH1478
Share Chair, 90° Inside Curved Task Height

2. Leg

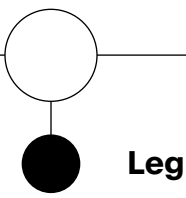

Leg
L1 CORNER LEG, ADJ. PLASTIC GLIDES
L2 ROUND LEG, ADJ. PLASTIC GLIDES
L3 WOOD LEG

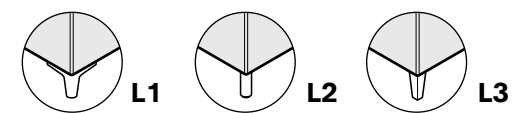

Mobility
The round leg glide has a larger diameter (1") than the corner leg for easier sliding on low pile carpet. Stylex is not responsible for damage to carpeting or floors.

3. Leg Finish

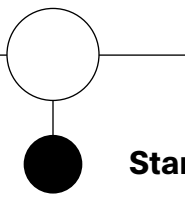

Standard Powder Coated Metal

BL	BLUE
BM	BLACK MATTE
BR	BRASS
BT	BLACK TWILIGHT
CP	CHAMPAGNE
DB	DARK BRONZE
DG	DARK GRAY
DP	DUSTY PINK
FG	FOREST GREEN
LG	LIGHT GRAY
MG	MEADOW GREEN
MK	MILK
MS	METALLIC SILVER

NK	NICKEL
NV	NAVY
OR	ORANGE
PY	PALE YELLOW
RD	RED
RO	RED ORANGE
RR	RUSTY RED
SB	SOFT BLUE
SD	SAND
TC	TERRACOTTA
TP	TAUPE
TS	TEXTURED SLATE
YL	YELLOW

4. Options



Polished Aluminum
AL POLISHED ALUMINUM

Wood Finish +309
81 WHITE OAK
83 NATURAL MAPLE
85 WALNUT

Custom Color Match
09 CUSTOM COLOR +0

Per order per color - 20 chair minimum.
Contact customer service for details.

4. Options



Ganging
SG GANGING +51

Used to connect chairs to adjacent chairs or benches.

Power
IN-SEAT POWER PORT W/10' CORD +435
C1X
IN-SEAT POWER PORT W/20' CORD +466
C2X

See [page 7](#) for power port spec info.

Power Port Finish
Power ports can be finished in any standard powder coat available.

5. Upholstery Style



Upholstery Style
U1 MONO-COLOR WATERLINE
U2 DUAL-COLOR WATERLINE
U3 SEAT & BACK, NO WATERLINE
U4 SEAT & BACK, WITH WATERLINE
U8 TRI-COLOR - SEAT, BACK & WATERLINE

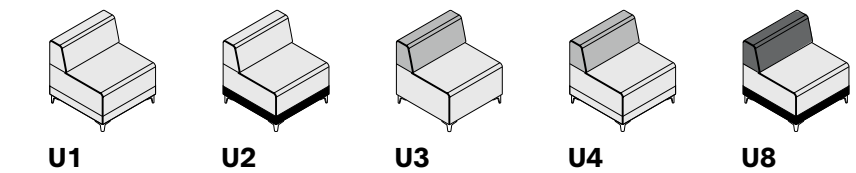

When pricing models with more than one fabric, the higher grade fabric will determine the overall grade of the specific product.

6. Upholstery

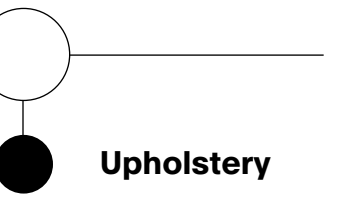

Upholstery
See [general information section](#) for details on textile program and COM/COL information.

Share will develop comfort wrinkles over time. The extent of these wrinkles is determined by the fabric specified.

Share

CHAIR: 90° OUTSIDE CURVED, LOUNGE HEIGHT

Textile Upholstery Grades

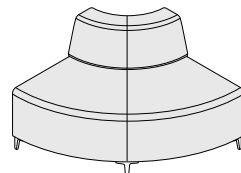
TITLE	SERIES	TYPE	SEAT	UPH	DIMENSIONS	YDG	COM	A	B	C	D	E	F	G	H	I	J	K	L	M
Chair, 90° Outside Curved, Lounge Height 	Standard Upholstery	SH	15	76	56.25W x 28D x 29H	4.5	3,086	3,446	3,642	3,833	4,029	4,224	4,438	4,653	4,907	5,234	5,624	6,015	6,402	6,794
	Mono-Color Waterline	SH	15	76	56.25W x 28D x 29H	4.5	3,339	3,699	3,896	4,085	4,282	4,477	4,690	4,907	5,158	5,486	5,877	6,269	6,654	7,047
	Dual-Color Waterline	SH	15	76	56.25W x 28D x 29H	3.8 above Waterline 1 below Waterline	3,339	3,723	3,931	4,134	4,342	4,551	4,781	5,010	5,277	5,629	6,048	6,463	6,875	7,292
	No Waterline Back & Seat	SH	15	76	56.25W x 28D x 29H	2.53 Back 3.3 Seat	3,086	3,446	3,642	3,833	4,029	4,224	4,438	4,653	4,907	5,234	5,624	6,015	6,402	6,794
	Waterline Back & Seat	SH	15	76	56.25W x 28D x 29H	2.3 Back 3 Seat/below Waterline	3,339	3,699	3,896	4,085	4,282	4,477	4,690	4,907	5,158	5,486	5,877	6,269	6,654	7,047
	Triple-Back & Seat & Waterline	SH	15	76	56.25W x 28D x 29H	0.8 below Waterline 2.3 Back 3 Seat/above Waterline	3,339	3,723	3,931	4,134	4,342	4,551	4,781	5,010	5,277	5,629	6,048	6,463	6,875	7,292

To Order Select Below

1. Series/Type/Seat

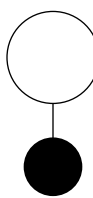

SH1576

Share
Chair, 90° Outside Curved,
Lounge Height

2. Leg

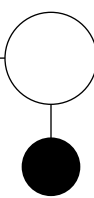

Leg

- L1 CORNER LEG, ADJ. PLASTIC GLIDES
- L2 ROUND LEG, ADJ. PLASTIC GLIDES
- L3 WOOD LEG

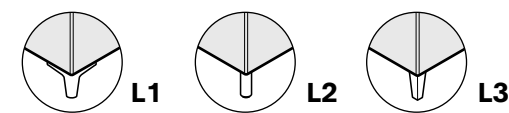

Mobility

The round leg glide has a larger diameter (1") than the corner leg for easier sliding on low pile carpet. Stylex is not responsible for damage to carpeting or floors.

3. Leg Finish

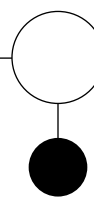

Standard Powder Coated Metal

- BL BLUE
- BM BLACK MATTE
- BR BRASS
- BT BLACK TWILIGHT
- CP CHAMPAGNE
- DB DARK BRONZE
- DG DARK GRAY
- DP DUSTY PINK
- FG FOREST GREEN
- LG LIGHT GRAY
- MG MEADOW GREEN
- MK MILK
- MS METALLIC SILVER

- NK NICKEL
- NV NAVY
- OR ORANGE
- PY PALE YELLOW
- RD RED
- RO RED ORANGE
- RR RUSTY RED
- SB SOFT BLUE
- SD SAND
- TC TERRACOTTA
- TP TAUPE
- TS TEXTURED SLATE
- YL YELLOW

4. Options

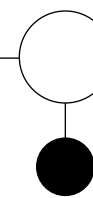

Ganging

- SG GANGING **+51**

Used to connect chairs to adjacent chairs or benches.

Power

- C1X IN-SEAT POWER PORT W/10' CORD **+435**
- C2X IN-SEAT POWER PORT W/20' CORD **+466**

See [page 7](#) for power port spec info.

Power Port Finish

Power ports can be finished in any standard powder coat available.

5. Upholstery Style

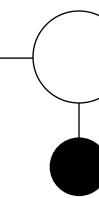

Upholstery Style

- U1 MONO-COLOR WATERLINE
- U2 DUAL-COLOR WATERLINE
- U3 SEAT & BACK, NO WATERLINE
- U4 SEAT & BACK, WITH WATERLINE
- U8 TRI-COLOR - SEAT, BACK & WATERLINE

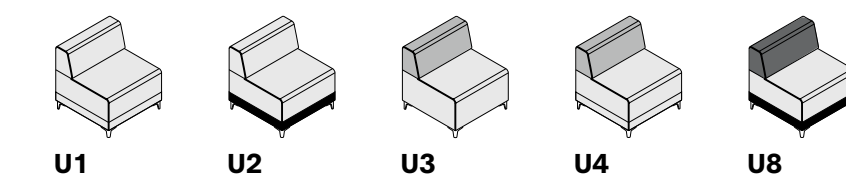

When pricing models with more than one fabric, the higher grade fabric will determine the overall grade of the specific product.

6. Upholstery

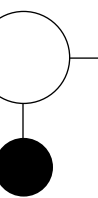

Upholstery

See [general information section](#) for details on textile program and COM/COL information.

Share will develop comfort wrinkles over time. The extent of these wrinkles is determined by the fabric specified.

Share

CHAIR: 90° OUTSIDE CURVED, TASK HEIGHT

Textile Upholstery Grades

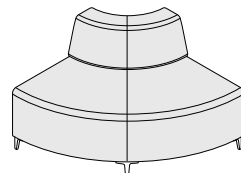
TITLE	SERIES	TYPE	SEAT	UPH	DIMENSIONS	YDG	COM	A	B	C	D	E	F	G	H	I	J	K	L	M
Chair, 90° Outside Curved, Task Height 	Standard Upholstery	SH	15	78	56.25W x 28D x 29H	4.5	3,086	3,446	3,642	3,833	4,029	4,224	4,438	4,653	4,907	5,234	5,624	6,015	6,402	6,794
	Mono-Color Waterline	SH	15	78	56.25W x 28D x 29H	4.5	3,339	3,699	3,896	4,085	4,282	4,477	4,690	4,907	5,158	5,486	5,877	6,269	6,654	7,047
	Dual-Color Waterline	SH	15	78	56.25W x 28D x 29H	3.7 above Waterline 1 below Waterline	3,339	3,715	3,920	4,118	4,321	4,526	4,750	4,975	5,240	5,581	5,989	6,399	6,802	7,209
	No Waterline Back & Seat	SH	15	78	56.25W x 28D x 29H	2.31 Back 3.3 Seat	3,086	3,446	3,642	3,833	4,029	4,224	4,438	4,653	4,907	5,234	5,624	6,015	6,402	6,794
	Waterline Back & Seat	SH	15	78	56.25W x 28D x 29H	2.1 Back 2.7 Seat/below Waterline	3,339	3,699	3,896	4,085	4,282	4,477	4,690	4,907	5,158	5,486	5,877	6,269	6,654	7,047
	Triple-Back & Seat & Waterline	SH	15	78	56.25W x 28D x 29H	0.9 below Waterline 2.1 Back 2.7 Seat/above Waterline	3,339	3,715	3,920	4,118	4,321	4,526	4,750	4,975	5,240	5,581	5,989	6,399	6,802	7,209

To Order Select Below

1. Series/Type/Seat

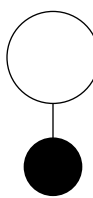

SH1578

Share
Chair, 90° Outside Curved,
Task Height

2. Leg

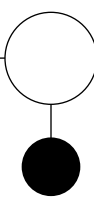

Leg

- L1 CORNER LEG, ADJ. PLASTIC GLIDES
- L2 ROUND LEG, ADJ. PLASTIC GLIDES
- L3 WOOD LEG

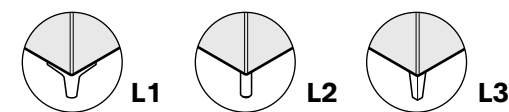

Mobility

The round leg glide has a larger diameter (1") than the corner leg for easier sliding on low pile carpet. Stylex is not responsible for damage to carpeting or floors.

3. Leg Finish

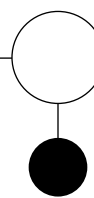

Standard Powder Coated Metal

- BL BLUE
- BM BLACK MATTE
- BR BRASS
- BT BLACK TWILIGHT
- CP CHAMPAGNE
- DB DARK BRONZE
- DG DARK GRAY
- DP DUSTY PINK
- FG FOREST GREEN
- LG LIGHT GRAY
- MG MEADOW GREEN
- MK MILK
- MS METALLIC SILVER

- NK NICKEL
- NV NAVY
- OR ORANGE
- PY PALE YELLOW
- RD RED
- RO RED ORANGE
- RR RUSTY RED
- SB SOFT BLUE
- SD SAND
- TC TERRACOTTA
- TP TAUPE
- TS TEXTURED SLATE
- YL YELLOW

4. Options

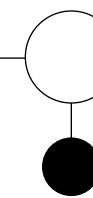

Ganging

- SG GANGING **+51**

Used to connect chairs to adjacent chairs or benches.

Power

- IN-SEAT POWER
C1X PORT W/10' CORD **+435**
- IN-SEAT POWER
C2X PORT W/20' CORD **+466**

See [page 7](#) for power port spec info.

Power Port Finish

Power ports can be finished in any standard powder coat available.

5. Upholstery Style

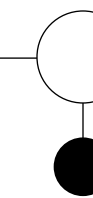

Upholstery Style

- U1 MONO-COLOR WATERLINE
- U2 DUAL-COLOR WATERLINE
- U3 SEAT & BACK, NO WATERLINE
- U4 SEAT & BACK, WITH WATERLINE
- U8 TRI-COLOR - SEAT, BACK & WATERLINE

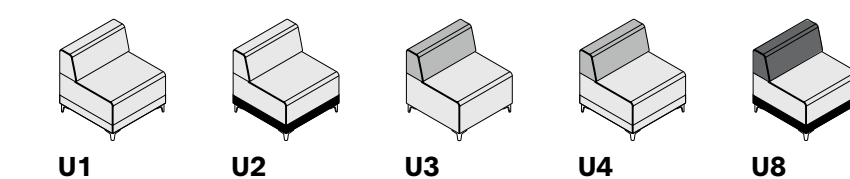

When pricing models with more than one fabric, the higher grade fabric will determine the overall grade of the specific product.

6. Upholstery

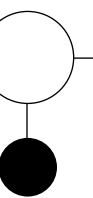

Upholstery

See [general information section](#) for details on textile program and COM/COL information.

Share will develop comfort wrinkles over time. The extent of these wrinkles is determined by the fabric specified.

Share

BENCH: SINGLE-SEATER

Textile Upholstery Grades

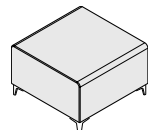
TITLE		SERIES	TYPE	SEAT	UPH	DIMENSIONS	YDG	COM	A	B	C	D	E	F	G	H	I	J	K	L	M
 Bench, Single-Seater, Lounge Height	Standard Upholstery	SH	01	16		28W x 28D x 16H	1.6	1,403	1,532	1,603	1,674	1,743	1,815	1,894	1,972	2,064	2,180	2,323	2,382	2,517	2,629
	Mono-Color Waterline	SH	01	16	U1	28W x 28D x 16H	1.7	1,513	1,642	1,714	1,783	1,855	1,927	2,004	2,082	2,174	2,293	2,433	2,554	2,697	2,816
	Dual-Color Waterline	SH	01	16	U2	28W x 28D x 16H	1.3 above Waterline 0.8 below Waterline	1,513	1,683	1,777	1,869	1,962	2,056	2,157	2,260	2,379	2,536	2,781	2,799	2,975	3,122
Bench, Single-Seater, Task Height	Standard Upholstery	SH	01	18		28W x 28D x 18H	1.6	1,403	1,541	1,616	1,689	1,766	1,841	1,926	2,008	2,103	2,229	2,379	2,382	2,517	2,629
	Mono-Color Waterline	SH	01	18	U1	28W x 28D x 18H	1.7	1,513	1,651	1,727	1,802	1,876	1,954	2,035	2,117	2,216	2,340	2,492	2,554	2,697	2,816
	Dual-Color Waterline	SH	01	18	U2	28W x 28D x 18H	1.4 above Waterline 0.8 below Waterline	1,513	1,689	1,789	1,885	1,981	2,080	2,187	2,295	2,422	2,584	2,835	2,860	3,045	3,199

To Order Select Below

1. Series/Type/Seat

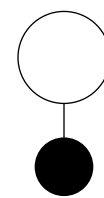

SH0116

Share Bench, Single-Seater, Lounge Height

SH0118

Share Bench, Single-Seater, Task Height

2. Leg

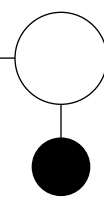

Leg

L1 CORNER LEG, ADJ. PLASTIC GLIDES

L2 ROUND LEG, ADJ. PLASTIC GLIDES

L3 WOOD LEG

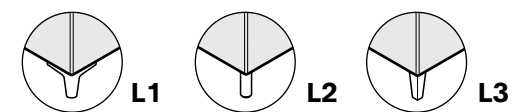

Mobility

The round leg glide has a larger diameter (1") than the corner leg for easier sliding on low pile carpet. Stylex is not responsible for damage to carpeting or floors.

3. Leg Finish

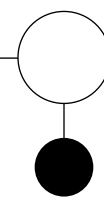

Standard Powder Coated Metal

BL BLUE

BM BLACK MATTE

BR BRASS

BT BLACK TWILIGHT

CP CHAMPAGNE

DB DARK BRONZE

DG DARK GRAY

DP DUSTY PINK

FG FOREST GREEN

LG LIGHT GRAY

MG MEADOW GREEN

MK MILK

MS METALLIC SILVER

NK NICKEL

NV NAVY

OR ORANGE

PY PALE YELLOW

RD RED

RO RED ORANGE

RR RUSTY RED

SB SOFT BLUE

SD SAND

TC TERRACOTTA

TP TAUPE

TS TEXTURED SLATE

YL YELLOW

4. Options

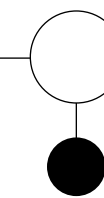

Ganging

SG GANGING **+51**

Used to connect chairs to adjacent chairs or benches.

Power

C1X IN-SEAT POWER PORT W/10' CORD **+435**

C2X IN-SEAT POWER PORT W/20' CORD **+466**

See [page 7](#) for power port spec info.

Power Port Finish

Power ports can be finished in any standard powder coat available.

5. Upholstery Style

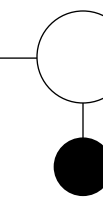

Upholstery Style

U1 MONO-COLOR WATERLINE

U2 DUAL-COLOR WATERLINE

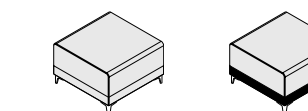

U1

U2

When pricing models with more than one fabric, the higher grade fabric will determine the overall grade of the specific product.

6. Upholstery

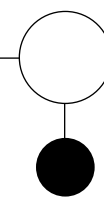

Upholstery

See general information section for details on textile program and COM/COL information.

Share will develop comfort wrinkles over time. The extent of these wrinkles is determined by the fabric specified.

Share

BENCH: TWO-SEATER

Textile Upholstery Grades

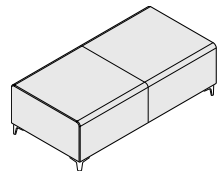
TITLE		SERIES	TYPE	SEAT	UPH	DIMENSIONS	YDG	COM	A	B	C	D	E	F	G	H	I	J	K	L	M
Bench, Two-Seater, Lounge Height 	Standard Upholstery	SH	01	26		56W x 28D x 16H	3.2	2,141	2,399	2,540	2,683	2,823	2,966	3,121	3,278	3,462	3,698	3,982	4,100	4,369	4,593
	Mono-Color Waterline	SH	01	26	U1	56W x 28D x 16H	3.2	2,398	2,657	2,800	2,942	3,082	3,226	3,380	3,535	3,719	3,955	4,239	4,357	4,626	4,850
	Dual-Color Waterline	SH	01	26	U2	56W x 28D x 16H	2.5 above Waterline 0.9 below Waterline	2,398	2,675	2,823	2,975	3,124	3,276	3,442	3,607	3,801	4,053	4,356	4,479	4,765	5,004
Bench, Two-Seater, Task Height	Standard Upholstery	SH	01	28		56W x 28D x 18H	3.4	2,141	2,415	2,566	2,718	2,865	3,018	3,185	3,348	3,545	3,796	4,096	4,222	4,508	4,747
	Mono-Color Waterline	SH	01	28	U1	56W x 28D x 18H	3.4	2,398	2,675	2,823	2,975	3,124	3,276	3,442	3,607	3,801	4,053	4,356	4,479	4,765	5,004
	Dual-Color Waterline	SH	01	28	U2	56W x 28D x 18H	2.7 above Waterline 0.9 below Waterline	2,398	2,691	2,850	3,009	3,167	3,327	3,503	3,680	3,884	4,152	4,469	4,602	4,904	5,157

To Order Select Below

1. Series/Type/Seat

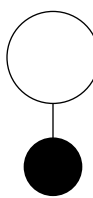

SH0126

**Share
Bench, Two-Seater,
Lounge Height**

SH0128

**Share
Bench, Two-Seater,
Task Height**

2. Leg

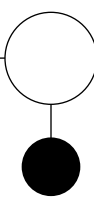

Leg

L1 CORNER LEG, ADJ. PLASTIC GLIDES

L2 ROUND LEG, ADJ. PLASTIC GLIDES

L3 WOOD LEG

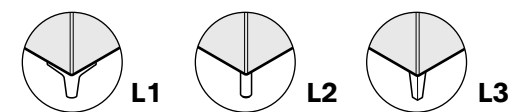

Mobility

The round leg glide has a larger diameter (1") than the corner leg for easier sliding on low pile carpet. Stylex is not responsible for damage to carpeting or floors.

3. Leg Finish

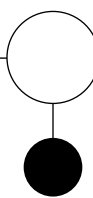

Standard Powder Coated Metal

BL BLUE

BM BLACK MATTE

BR BRASS

BT BLACK TWILIGHT

CP CHAMPAGNE

DB DARK BRONZE

DG DARK GRAY

DP DUSTY PINK

FG FOREST GREEN

LG LIGHT GRAY

MG MEADOW GREEN

MK MILK

MS METALLIC SILVER

NK NICKEL

NV NAVY

OR ORANGE

PY PALE YELLOW

RD RED

RO RED ORANGE

RR RUSTY RED

SB SOFT BLUE

SD SAND

TC TERRACOTTA

TP TAUPE

TS TEXTURED SLATE

YL YELLOW

4. Options

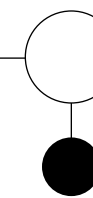

Ganging

SG GANGING **+51**

Used to connect chairs to adjacent chairs or benches.

Power

IN-SEAT POWER
C1X PORT W/10' CORD **+435**

IN-SEAT POWER
C2X PORT W/20' CORD **+466**

See [page 7](#) for power port spec info.

Power Port Finish

Power ports can be finished in any standard powder coat available.

5. Upholstery Style

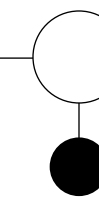

Upholstery Style

U1 MONO-COLOR WATERLINE

U2 DUAL-COLOR WATERLINE

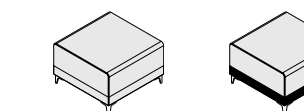

U1

U2

When pricing models with more than one fabric, the higher grade fabric will determine the overall grade of the specific product.

6. Upholstery

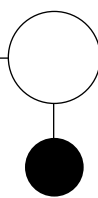

Upholstery

See general information section for details on textile program and COM/COL information.

Share will develop comfort wrinkles over time. The extent of these wrinkles is determined by the fabric specified.

Share

BENCH: THREE-SEATER

Textile Upholstery Grades

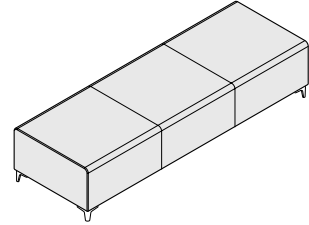
TITLE		SERIES	TYPE	SEAT	UPH	DIMENSIONS	YDG	COM	A	B	C	D	E	F	G	H	I	J	K	L	M
Bench, Three-Seater, Lounge Height 	Standard Upholstery	SH	01	36		84W x 28D x 16H	4.9	3,394	3,794	4,010	4,226	4,442	4,660	4,898	5,135	5,418	5,780	6,213	6,394	6,805	7,149
	Mono-Color Waterline	SH	01	36	U1	84W x 28D x 16H	4.9	3,765	4,162	4,377	4,594	4,811	5,028	5,267	5,506	5,788	6,149	6,584	6,765	7,176	7,520
	Dual-Color Waterline	SH	01	36	U2	84W x 28D x 16H	3.7 above Waterline 1.6 below Waterline	3,765	4,194	4,428	4,663	4,898	5,130	5,389	5,647	5,952	6,342	6,813	7,010	7,455	7,827
Bench, Three-Seater, Task Height	Standard Upholstery	SH	01	38		84W x 28D x 18H	5.2	3,394	3,817	4,045	4,276	4,507	4,736	4,990	5,243	5,543	5,925	6,387	6,577	7,014	7,379
	Mono-Color Waterline	SH	01	38	U1	84W x 28D x 18H	5.2	3,765	4,185	4,414	4,645	4,875	5,106	5,359	5,612	5,912	6,296	6,756	6,948	7,385	7,750
	Dual-Color Waterline	SH	01	38	U2	84W x 28D x 18H	4 above Waterline 1.6 below Waterline	3,765	4,219	4,466	4,715	4,961	5,208	5,481	5,755	6,078	6,490	6,986	7,193	7,664	8,057

To Order Select Below

1. Series/Type/Seat

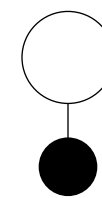

SH0136

**Share
Bench, Three-Seater,
Lounge Height**

SH0138

**Share
Bench, Three-Seater,
Task Height**

2. Leg

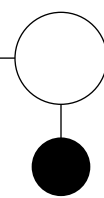

Leg

L1 CORNER LEG, ADJ. PLASTIC GLIDES

L2 ROUND LEG, ADJ. PLASTIC GLIDES

L3 WOOD LEG

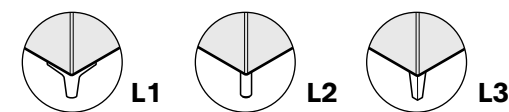

Mobility

The round leg glide has a larger diameter (1") than the corner leg for easier sliding on low pile carpet. Stylex is not responsible for damage to carpeting or floors.

3. Leg Finish

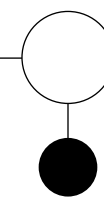

Standard Powder Coated Metal

BL BLUE

BM BLACK MATTE

BR BRASS

BT BLACK TWILIGHT

CP CHAMPAGNE

DB DARK BRONZE

DG DARK GRAY

DP DUSTY PINK

FG FOREST GREEN

LG LIGHT GRAY

MG MEADOW GREEN

MK MILK

MS METALLIC SILVER

NK NICKEL

NV NAVY

OR ORANGE

PY PALE YELLOW

RD RED

RO RED ORANGE

RR RUSTY RED

SB SOFT BLUE

SD SAND

TC TERRACOTTA

TP TAUPE

TS TEXTURED SLATE

YL YELLOW

4. Options

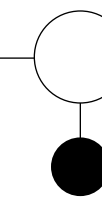

Ganging

SG GANGING **+51**

Used to connect chairs to adjacent chairs or benches.

Power

IN-SEAT POWER
C1X PORT W/10' CORD **+435**

IN-SEAT POWER
C2X PORT W/20' CORD **+466**

See [page 7](#) for power port spec info.

Power Port Finish

Power ports can be finished in any standard powder coat available.

5. Upholstery Style

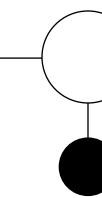

Upholstery Style

U1 MONO-COLOR WATERLINE

U2 DUAL-COLOR WATERLINE

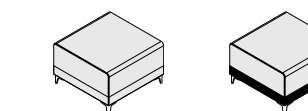

U1

U2

When pricing models with more than one fabric, the higher grade fabric will determine the overall grade of the specific product.

6. Upholstery

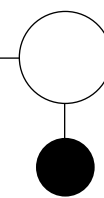

Upholstery

See general information section for details on textile program and COM/COL information.

Share will develop comfort wrinkles over time. The extent of these wrinkles is determined by the fabric specified.

Share

BENCH: 120° CORNER

Textile Upholstery Grades

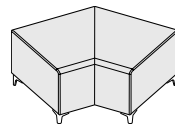
TITLE	SERIES	TYPE	SEAT	UPH	DIMENSIONS	YDG	COM	A	B	C	D	E	F	G	H	I	J	K	L	M
 Bench, 120° Corner, Lounge Height	Standard Upholstery	SH	02	46	42.5W x 28D x 16H	2.4	2,864	3,056	3,157	3,260	3,364	3,467	3,581	3,695	3,828	3,999	4,206	4,333	4,535	4,703
	Mono-Color Waterline	SH	02	46	42.5W x 28D x 16H	2.1	3,116	3,280	3,372	3,462	3,552	3,642	3,741	3,840	3,960	4,109	4,290	4,402	4,578	4,725
	Dual-Color Waterline	SH	02	46	42.5W x 28D x 16H	1.7 above Waterline 0.8 below Waterline	3,116	3,313	3,419	3,528	3,634	3,742	3,861	3,980	4,120	4,298	4,513	4,646	4,856	5,032
Bench, 120° Corner, Task Height	Standard Upholstery	SH	02	48	42.5W x 28D x 18H	2.5	2,864	3,062	3,170	3,277	3,384	3,491	3,611	3,730	3,868	4,046	4,262	4,394	4,604	4,780
	Mono-Color Waterline	SH	02	48	42.5W x 28D x 18H	2.2	3,116	3,289	3,383	3,478	3,573	3,668	3,772	3,875	3,998	4,157	4,344	4,463	4,648	4,802
	Dual-Color Waterline	SH	02	48	42.5W x 28D x 18H	1.9 above Waterline 0.8 below Waterline	3,116	3,327	3,445	3,562	3,675	3,794	3,921	4,048	4,198	4,392	4,624	4,769	4,996	5,185

To Order Select Below

1. Series/Type/Seat

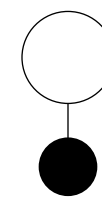

SH0246

Share
Bench, 120° Corner,
Lounge Height

SH0248

Share
Bench, 120° Corner,
Task Height

2. Leg

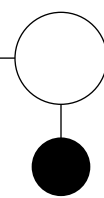

Leg

L1 CORNER LEG, ADJ. PLASTIC GLIDES

L2 ROUND LEG, ADJ. PLASTIC GLIDES

L3 WOOD LEG

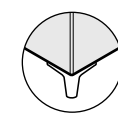

L1

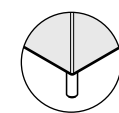

L2

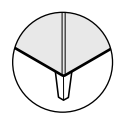

L3

Mobility

The round leg glide has a larger diameter (1") than the corner leg for easier sliding on low pile carpet. Stylex is not responsible for damage to carpeting or floors.

3. Leg Finish

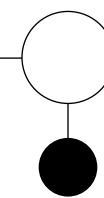

Standard Powder Coated Metal

BL BLUE

BM BLACK MATTE

BR BRASS

BT BLACK TWILIGHT

CP CHAMPAGNE

DB DARK BRONZE

DG DARK GRAY

DP DUSTY PINK

FG FOREST GREEN

LG LIGHT GRAY

MG MEADOW GREEN

MK MILK

MS METALLIC SILVER

NK NICKEL

NV NAVY

OR ORANGE

PY PALE YELLOW

RD RED

RO RED ORANGE

RR RUSTY RED

SB SOFT BLUE

SD SAND

TC TERRACOTTA

TP TAUPE

TS TEXTURED SLATE

YL YELLOW

4. Options

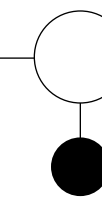

Ganging

SG GANGING **+51**

Used to connect chairs to adjacent chairs or benches.

Power

C1X IN-SEAT POWER PORT W/10' CORD **+435**

C2X IN-SEAT POWER PORT W/20' CORD **+466**

See [page 7](#) for power port spec info.

Power Port Finish

Power ports can be finished in any standard powder coat available.

5. Upholstery Style

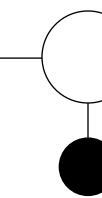

Upholstery Style

U1 MONO-COLOR WATERLINE

U2 DUAL-COLOR WATERLINE

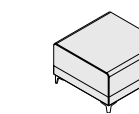

U1

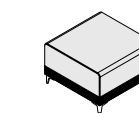

U2

When pricing models with more than one fabric, the higher grade fabric will determine the overall grade of the specific product.

6. Upholstery

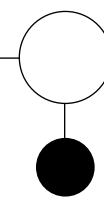

Upholstery

See general information section for details on textile program and COM/COL information.

Share will develop comfort wrinkles over time. The extent of these wrinkles is determined by the fabric specified.

Share

BENCH: 30° INSIDE CORNER

Textile Upholstery Grades

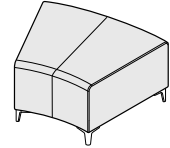
TITLE		SERIES	TYPE	SEAT	UPH	DIMENSIONS	YDG	COM	A	B	C	D	E	F	G	H	I	J	K	L	M
 Bench, 30° Inside Curved, Lounge Height	Standard Upholstery	SH	04	56		35W x 28D x 16H	2.4	2,367	2,371	2,481	2,590	2,701	2,813	2,933	3,056	3,198	3,384	3,607	3,683	3,893	4,108
	Mono-Color Waterline	SH	04	56	U1	35W x 28D x 16H	2.4	2,367	2,570	2,682	2,788	2,902	3,012	3,134	3,256	3,400	3,587	3,807	3,877	4,086	4,300
	Dual-Color Waterline	SH	04	56	U2	35W x 28D x 16H	1.9 above Waterline 0.8 below Waterline	2,367	2,597	2,724	2,842	2,966	3,093	3,231	3,368	3,527	3,738	3,986	4,075	4,312	4,552
Bench, 30° Inside Curved, Task Height	Standard Upholstery	SH	04	58		35W x 28D x 18H	2.4	2,367	2,371	2,481	2,590	2,701	2,813	2,933	3,056	3,198	3,384	3,607	3,683	3,893	4,108
	Mono-Color Waterline	SH	04	58	U1	35W x 28D x 18H	2.4	2,367	2,570	2,682	2,788	2,902	3,012	3,134	3,256	3,400	3,587	3,807	3,877	4,086	4,300
	Dual-Color Waterline	SH	04	58	U2	35W x 28D x 18H	1.6 above Waterline 0.8 below Waterline	2,367	2,570	2,682	2,788	2,902	3,012	3,134	3,256	3,400	3,587	3,807	3,877	4,086	4,300

To Order Select Below

1. Series/Type/Seat

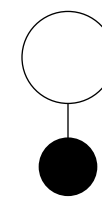

SH0456

Share
Bench, 30° Inside Curved, Lounge Height

SH0458

Share
Bench, 30° Inside Curved, Task Height

2. Leg

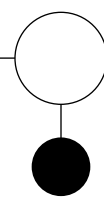

Leg

L1 CORNER LEG, ADJ. PLASTIC GLIDES

L2 ROUND LEG, ADJ. PLASTIC GLIDES

L3 WOOD LEG

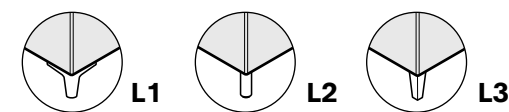

Mobility

The round leg glide has a larger diameter (1") than the corner leg for easier sliding on low pile carpet. Stylex is not responsible for damage to carpeting or floors.

3. Leg Finish

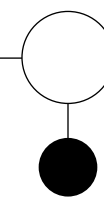

Standard Powder Coated Metal

BL BLUE

BM BLACK MATTE

BR BRASS

BT BLACK TWILIGHT

CP CHAMPAGNE

DB DARK BRONZE

DG DARK GRAY

DP DUSTY PINK

FG FOREST GREEN

LG LIGHT GRAY

MG MEADOW GREEN

MK MILK

MS METALLIC SILVER

NK NICKEL

NV NAVY

OR ORANGE

PY PALE YELLOW

RD RED

RO RED ORANGE

RR RUSTY RED

SB SOFT BLUE

SD SAND

TC TERRACOTTA

TP TAUPE

TS TEXTURED SLATE

YL YELLOW

4. Options

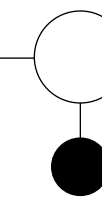

Ganging

SG GANGING **+51**

Used to connect chairs to adjacent chairs or benches.

Power

IN-SEAT POWER
C1X PORT W/10' CORD **+435**

IN-SEAT POWER
C2X PORT W/20' CORD **+466**

See [page 7](#) for power port spec info.

Power Port Finish

Power ports can be finished in any standard powder coat available.

5. Upholstery Style

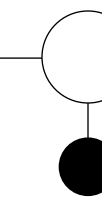

Upholstery Style

U1 MONO-COLOR WATERLINE

U2 DUAL-COLOR WATERLINE

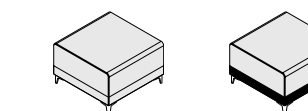

U1

U2

When pricing models with more than one fabric, the higher grade fabric will determine the overall grade of the specific product.

6. Upholstery

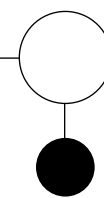

Upholstery

See general information section for details on textile program and COM/COL information.

Share will develop comfort wrinkles over time. The extent of these wrinkles is determined by the fabric specified.

Share

BENCH: 60° INSIDE CORNER

Textile Upholstery Grades

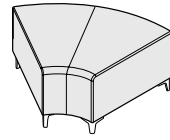
TITLE	SERIES	TYPE	SEAT	UPH	DIMENSIONS	YDG	COM	A	B	C	D	E	F	G	H	I	J	K	L	M	
 Bench, 60° Inside Curved, Lounge Height	Standard Upholstery	SH	04	66	39.75W x 28D x 16H	2.5	2,591	2,610	2,733	2,849	2,967	3,090	3,222	3,354	3,509	3,710	3,951	4,030	4,259	4,490	
	Mono-Color Waterline	SH	04	66	U1	39.75W x 28D x 16H	2.5	2,591	2,813	2,932	3,049	3,168	3,289	3,421	3,554	3,709	3,912	4,153	4,224	4,453	4,684
	Dual-Color Waterline	SH	04	66	U2	39.75W x 28D x 16H	2 above Waterline 0.8 below Waterline	2,591	2,831	2,958	3,084	3,213	3,344	3,486	3,628	3,796	4,012	4,274	4,358	4,603	4,852
Bench, 60° Inside Curved, Task Height	Standard Upholstery	SH	04	68	39.75W x 28D x 18H	2.6	2,591	2,680	2,795	2,906	3,022	3,137	3,266	3,392	3,543	3,735	3,968	4,038	4,257	4,479	
	Mono-Color Waterline	SH	04	68	U1	39.75W x 28D x 18H	2.6	2,591	2,878	2,994	3,106	3,224	3,338	3,464	3,592	3,740	3,935	4,165	4,229	4,450	4,673
	Dual-Color Waterline	SH	04	68	U2	39.75W x 28D x 18H	2.5 above Waterline 0.8 below Waterline	2,665	2,947	3,099	3,247	3,402	3,553	3,721	3,887	4,086	4,341	4,649	4,762	5,054	5,346

To Order Select Below

1. Series/Type/Seat

SH0466

Share
Bench, 60° Inside Curved, Lounge Height

SH0468

Share
Bench, 60° Inside Curved, Task Height

2. Leg

Leg

L1 CORNER LEG, ADJ. PLASTIC GLIDES
L2 ROUND LEG, ADJ. PLASTIC GLIDES
L3 WOOD LEG

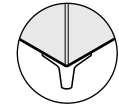
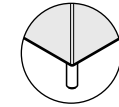
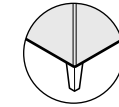
 L1  L2  L3

Mobility
The round leg glide has a larger diameter (1") than the corner leg for easier sliding on low pile carpet. Stylex is not responsible for damage to carpeting or floors.

3. Leg Finish

Standard Powder Coated Metal

BL BLUE
BM BLACK MATTE
BR BRASS
BT BLACK TWILIGHT
CP CHAMPAGNE
DB DARK BRONZE
DG DARK GRAY
DP DUSTY PINK
FG FOREST GREEN
LG LIGHT GRAY
MG MEADOW GREEN
MK MILK
MS METALLIC SILVER

NK NICKEL
NV NAVY
OR ORANGE
PY PALE YELLOW
RD RED
RO RED ORANGE
RR RUSTY RED
SB SOFT BLUE
SD SAND
TC TERRACOTTA
TP TAUPE
TS TEXTURED SLATE
YL YELLOW

4. Options

Polished Aluminum

AL POLISHED ALUMINUM

Wood Finish +309

81 WHITE OAK
83 NATURAL MAPLE
85 WALNUT

Custom Color Match

09 CUSTOM COLOR +0

Per order per color - 20 chair minimum.
Contact customer service for details.

Ganging

SG GANGING +51

Used to connect chairs to adjacent chairs or benches.

Power

C1X IN-SEAT POWER PORT W/10' CORD +435

C2X IN-SEAT POWER PORT W/20' CORD +466

See [page 7](#) for power port spec info.

Power Port Finish

Power ports can be finished in any standard powder coat available.

5. Upholstery Style

Upholstery Style

U1 MONO-COLOR WATERLINE
U2 DUAL-COLOR WATERLINE

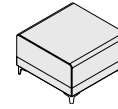
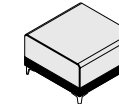
 U1  U2

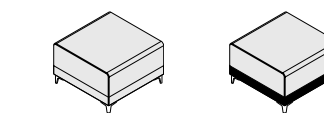

U1 U2

When pricing models with more than one fabric, the higher grade fabric will determine the overall grade of the specific product.

6. Upholstery

Upholstery

See general information section for details on textile program and COM/COL information.

Share will develop comfort wrinkles over time. The extent of these wrinkles is determined by the fabric specified.

Share

BENCH: 90° INSIDE CORNER

Textile Upholstery Grades

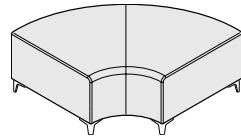
TITLE	SERIES	TYPE	SEAT	UPH	DIMENSIONS	YDG	COM	A	B	C	D	E	F	G	H	I	J	K	L	M
Bench, 90° Inside Curved, Lounge Height 	Standard Upholstery	SH	04	76	56.25W x 28D x 16H	3.5	3,257	3,287	3,448	3,605	3,768	3,929	4,107	4,284	4,493	4,767	5,090	5,206	5,514	5,825
	Mono-Color Waterline	SH	04	76	56.25W x 28D x 16H	3.5	3,257	3,556	3,716	3,876	4,037	4,199	4,375	4,553	4,762	5,036	5,359	5,464	5,773	6,084
	Dual-Color Waterline	SH	04	76	56.25W x 28D x 16H	3 above Waterline 0.8 below Waterline	3,257	3,583	3,756	3,925	4,101	4,278	4,472	4,664	4,892	5,188	5,540	5,664	5,998	6,338
Bench, 90° Inside Curved, Task Height	Standard Upholstery	SH	04	78	56.25W x 28D x 18H	3.5	3,257	3,363	3,523	3,680	3,843	4,005	4,182	4,361	4,569	4,841	5,164	5,278	5,585	5,897
	Mono-Color Waterline	SH	04	78	56.25W x 28D x 18H	3.5	3,257	3,631	3,792	3,949	4,112	4,274	4,451	4,628	4,837	5,109	5,435	5,536	5,843	6,155
	Dual-Color Waterline	SH	04	78	56.25W x 28D x 18H	2.7 above Waterline 0.8 below Waterline	3,333	3,631	3,792	3,949	4,112	4,274	4,451	4,628	4,837	5,109	5,435	5,536	5,843	6,155

To Order Select Below

1. Series/Type/Seat

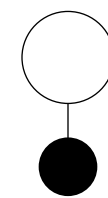

SH0476

Share
Bench, 90° Inside Curved, Lounge Height

SH0478

Share
Bench, 90° Inside Curved, Task Height

2. Leg

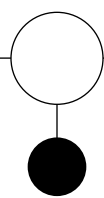

Leg

L1 CORNER LEG, ADJ. PLASTIC GLIDES

L2 ROUND LEG, ADJ. PLASTIC GLIDES

L3 WOOD LEG

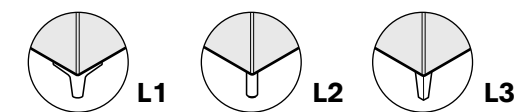

Mobility

The round leg glide has a larger diameter (1") than the corner leg for easier sliding on low pile carpet. Stylex is not responsible for damage to carpeting or floors.

3. Leg Finish

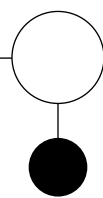

Standard Powder Coated Metal

BL BLUE

BM BLACK MATTE

BR BRASS

BT BLACK TWILIGHT

CP CHAMPAGNE

DB DARK BRONZE

DG DARK GRAY

DP DUSTY PINK

FG FOREST GREEN

LG LIGHT GRAY

MG MEADOW GREEN

MK MILK

MS METALLIC SILVER

NK NICKEL

NV NAVY

OR ORANGE

PY PALE YELLOW

RD RED

RO RED ORANGE

RR RUSTY RED

SB SOFT BLUE

SD SAND

TC TERRACOTTA

TP TAUPE

TS TEXTURED SLATE

YL YELLOW

4. Options

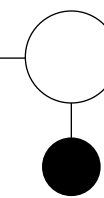

Ganging

SG GANGING **+51**

Used to connect chairs to adjacent chairs or benches.

Power

IN-SEAT POWER
C1X PORT W/10' CORD **+435**

IN-SEAT POWER
C2X PORT W/20' CORD **+466**

See [page 7](#) for power port spec info.

Power Port Finish

Power ports can be finished in any standard powder coat available.

5. Upholstery Style

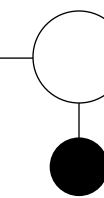

Upholstery Style

U1 MONO-COLOR WATERLINE

U2 DUAL-COLOR WATERLINE

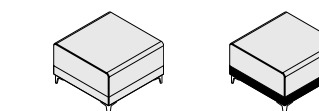

U1

U2

When pricing models with more than one fabric, the higher grade fabric will determine the overall grade of the specific product.

6. Upholstery

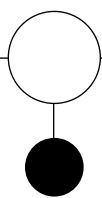

Upholstery

See general information section for details on textile program and COM/COL information.

Share will develop comfort wrinkles over time. The extent of these wrinkles is determined by the fabric specified.

Share

END CAP: SINGLE NARROW

Textile Upholstery Grades

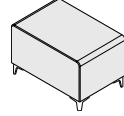
TITLE		SERIES	TYPE	SEAT	UPH	DIMENSIONS	YDG	COM	A	B	C	D	E	F	G	H	I	J	K	L	M
 End Cap, Single Narrow, Lounge Height	Standard Upholstery	SH	03	06		19W x 28D x 16H	1.6	1,256	1,384	1,456	1,527	1,597	1,670	1,744	1,824	1,915	2,033	2,175	2,235	2,370	2,482
	Mono-Color Waterline	SH	03	06	U1	19W x 28D x 16H	1.3	1,437	1,545	1,602	1,658	1,716	1,775	1,839	1,901	1,975	2,071	2,186	2,233	2,342	2,433
	Dual-Color Waterline	SH	03	06	U2	19W x 28D x 16H	1.3 above Waterline 0.4 below Waterline	1,437	1,577	1,651	1,728	1,802	1,877	1,960	2,042	2,142	2,266	2,416	2,478	2,621	2,740
End Cap, Single Narrow, Task Height	Standard Upholstery	SH	03	08		19W x 28D x 18H	1.7	1,256	1,392	1,468	1,544	1,617	1,693	1,777	1,857	1,958	2,082	2,231	2,297	2,440	2,559
	Mono-Color Waterline	SH	03	08	U1	19W x 28D x 18H	1.4	1,437	1,551	1,614	1,677	1,739	1,801	1,868	1,936	2,016	2,120	2,245	2,294	2,412	2,510
	Dual-Color Waterline	SH	03	08	U2	19W x 28D x 18H	1.4 above Waterline 0.4 below Waterline	1,437	1,586	1,664	1,743	1,824	1,903	1,991	2,078	2,183	2,315	2,475	2,539	2,690	2,816

To Order Select Below

1. Series/Type/Seat

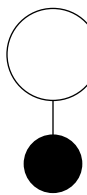

SH0306

Share
End Cap, Single Narrow,
Lounge Height

SH0308

Share
End Cap, Single Narrow,
Task Height

2. Leg



Leg

L1 CORNER LEG, ADJ. PLASTIC GLIDES

L2 ROUND LEG, ADJ. PLASTIC GLIDES

L3 WOOD LEG

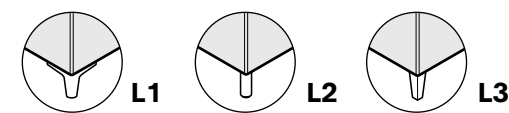

Mobility

The round leg glide has a larger diameter (1") than the corner leg for easier sliding on low pile carpet. Stylex is not responsible for damage to carpeting or floors.

3. Leg Finish



Standard Powder Coated Metal

BL BLUE

BM BLACK MATTE

BR BRASS

BT BLACK TWILIGHT

CP CHAMPAGNE

DB DARK BRONZE

DG DARK GRAY

DP DUSTY PINK

FG FOREST GREEN

LG LIGHT GRAY

MG MEADOW GREEN

MK MILK

MS METALLIC SILVER

NK NICKEL

NV NAVY

OR ORANGE

PY PALE YELLOW

RD RED

RO RED ORANGE

RR RUSTY RED

SB SOFT BLUE

SD SAND

TC TERRACOTTA

TP TAUPE

TS TEXTURED SLATE

YL YELLOW

4. Options

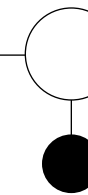

Ganging

SG GANGING **+51**

Used to connect chairs to adjacent chairs or benches.

Power

IN-SEAT POWER
C1X PORT W/10' CORD **+435**

IN-SEAT POWER
C2X PORT W/20' CORD **+466**

See [page 7](#) for power port spec info.

Power Port Finish

Power ports can be finished in any standard powder coat available.

5. Upholstery Style

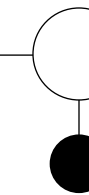

Upholstery Style

U1 MONO-COLOR WATERLINE

U2 DUAL-COLOR WATERLINE

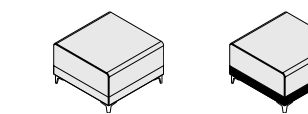

U1

U2

When pricing models with more than one fabric, the higher grade fabric will determine the overall grade of the specific product.

6. Upholstery

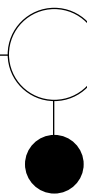

Upholstery

See general information section for details on textile program and COM/COL information.

Share will develop comfort wrinkles over time. The extent of these wrinkles is determined by the fabric specified.

Share

END CAP: DOUBLE NARROW

Textile Upholstery Grades

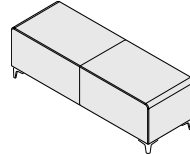
TITLE	SERIES	TYPE	SEAT	UPH	DIMENSIONS	YDG	COM	A	B	C	D	E	F	G	H	I	J	K	L	M	
 End Cap, Double Narrow, Lounge Height	Standard Upholstery	SH	03	16	19W x 56D x 16H	2	1,846	2,008	2,097	2,184	2,270	2,361	2,458	2,556	2,670	2,818	2,996	3,070	3,238	3,379	
	Mono-Color Waterline	SH	03	16	U1	19W x 56D x 16H	2	2,066	2,228	2,316	2,405	2,495	2,583	2,680	2,777	2,893	3,040	3,217	3,290	3,458	3,599
	Dual-Color Waterline	SH	03	16	U2	19W x 56D x 16H	1.8 above Waterline 0.8 below Waterline	2,066	2,277	2,393	2,507	2,621	2,736	2,863	2,989	3,142	3,333	3,562	3,658	3,876	4,059
End Cap, Double Narrow, Task Height	Standard Upholstery	SH	03	18	19W x 56D x 18H	2.1	1,846	2,014	2,108	2,200	2,294	2,388	2,486	2,591	2,712	2,865	3,052	3,132	3,308	3,455	
	Mono-Color Waterline	SH	03	18	U1	19W x 56D x 18H	2.2	2,066	2,245	2,342	2,439	2,537	2,636	2,742	2,849	2,975	3,138	3,333	3,413	3,598	3,752
	Dual-Color Waterline	SH	03	18	U2	19W x 56D x 18H	1.9 above Waterline 0.8 below Waterline	2,066	2,285	2,403	2,524	2,645	2,763	2,894	3,025	3,184	3,380	3,618	3,719	3,946	4,135

To Order Select Below

1. Series/Type/Seat

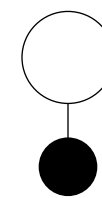

SH0316

Share
End Cap, Double Narrow, Lounge Height

SH0318

Share
End Cap, Double Narrow Task Height

2. Leg

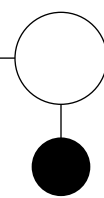

Leg

L1 CORNER LEG, ADJ. PLASTIC GLIDES

L2 ROUND LEG, ADJ. PLASTIC GLIDES

L3 WOOD LEG

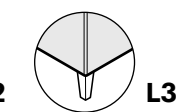
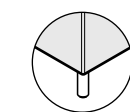
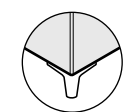

Mobility

The round leg glide has a larger diameter (1") than the corner leg for easier sliding on low pile carpet. Stylex is not responsible for damage to carpeting or floors.

3. Leg Finish

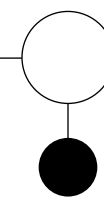

Standard Powder Coated Metal

BL BLUE

BM BLACK MATTE

BR BRASS

BT BLACK TWILIGHT

CP CHAMPAGNE

DB DARK BRONZE

DG DARK GRAY

DP DUSTY PINK

FG FOREST GREEN

LG LIGHT GRAY

MG MEADOW GREEN

MK MILK

MS METALLIC SILVER

NK NICKEL

NV NAVY

OR ORANGE

PY PALE YELLOW

RD RED

RO RED ORANGE

RR RUSTY RED

SB SOFT BLUE

SD SAND

TC TERRACOTTA

TP TAUPE

TS TEXTURED SLATE

YL YELLOW

4. Options

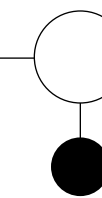

Ganging

SG GANGING **+51**

Used to connect chairs to adjacent chairs or benches.

Power

IN-SEAT POWER
C1X PORT W/10' CORD **+435**

IN-SEAT POWER
C2X PORT W/20' CORD **+466**

See [page 7](#) for power port spec info.

Power Port Finish

Power ports can be finished in any standard powder coat available.

5. Upholstery Style

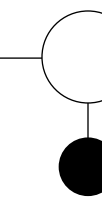

Upholstery Style

U1 MONO-COLOR WATERLINE

U2 DUAL-COLOR WATERLINE

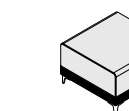
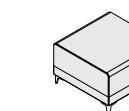

U1

U2

When pricing models with more than one fabric, the higher grade fabric will determine the overall grade of the specific product.

6. Upholstery

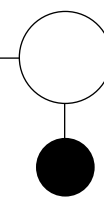

Upholstery

See general information section for details on textile program and COM/COL information.

Share will develop comfort wrinkles over time. The extent of these wrinkles is determined by the fabric specified.

Share

END CAP: DOUBLE NARROW +

Textile Upholstery Grades

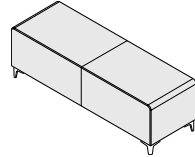
TITLE		SERIES	TYPE	SEAT	UPH	DIMENSIONS	YDG	COM	A	B	C	D	E	F	G	H	I	J	K	L	M
 End Cap, Double Narrow +, Lounge Height	Standard Upholstery	SH	03	26		19W x 57D x 16H	2.1	1,919	2,088	2,183	2,276	2,368	2,462	2,563	2,664	2,787	2,942	3,127	3,205	3,381	3,528
	Mono-Color Waterline	SH	03	26	U1	19W x 57D x 16H	2.1	2,141	2,309	2,401	2,496	2,589	2,682	2,784	2,889	3,007	3,161	3,348	3,427	3,603	3,750
	Dual-Color Waterline	SH	03	26	U2	19W x 57D x 16H	1.9 above Waterline 0.8 below Waterline	2,141	2,358	2,479	2,598	2,720	2,835	2,970	3,103	3,255	3,453	3,694	3,794	4,021	4,210
End Cap, Double Narrow +, Task Height	Standard Upholstery	SH	03	28		19W x 57D x 18H	2.1	1,919	2,088	2,183	2,276	2,368	2,462	2,563	2,664	2,787	2,942	3,127	3,205	3,381	3,528
	Mono-Color Waterline	SH	03	28	U1	19W x 57D x 18H	2.2	2,141	2,318	2,415	2,513	2,611	2,708	2,816	2,923	3,049	3,212	3,405	3,488	3,673	3,827
	Dual-Color Waterline	SH	03	28	U2	19W x 57D x 18H	1.9 above Waterline 0.8 below Waterline	2,141	2,358	2,479	2,598	2,720	2,835	2,970	3,103	3,255	3,453	3,694	3,794	4,021	4,210

To Order Select Below

1. Series/Type/Seat

SH0326
Share
End Cap, Double
Narrow +, Lounge Height

SH0328
Share
End Cap, Double
Narrow +, Task Height

2. Leg

Leg

L1 CORNER LEG, ADJ. PLASTIC GLIDES
 L2 ROUND LEG, ADJ. PLASTIC GLIDES
 L3 WOOD LEG

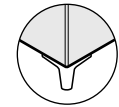
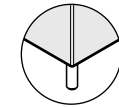
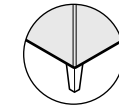
 **L1**  **L2**  **L3**

Mobility
 The round leg glide has a larger diameter (1") than the corner leg for easier sliding on low pile carpet. Stylex is not responsible for damage to carpeting or floors.

3. Leg Finish

Standard Powder Coated Metal

BL BLUE
 BM BLACK MATTE
 BR BRASS
 BT BLACK TWILIGHT
 CP CHAMPAGNE
 DB DARK BRONZE
 DG DARK GRAY
 DP DUSTY PINK
 FG FOREST GREEN
 LG LIGHT GRAY
 MG MEADOW GREEN
 MK MILK
 MS METALLIC SILVER

NK NICKEL
 NV NAVY
 OR ORANGE
 PY PALE YELLOW
 RD RED
 RO RED ORANGE
 RR RUSTY RED
 SB SOFT BLUE
 SD SAND
 TC TERRACOTTA
 TP TAUPE
 TS TEXTURED SLATE
 YL YELLOW

4. Options

Polished Aluminum

AL POLISHED ALUMINUM

Wood Finish +215

81 WHITE OAK
 83 NATURAL MAPLE
 85 WALNUT

Custom Color Match

09 CUSTOM COLOR

Per order per color - 20 chair minimum.
 Contact customer service for details.

Ganging

SG GANGING **+51**

Used to connect chairs to adjacent chairs or benches.

Power

IN-SEAT POWER
 C1X PORT W/10' CORD **+435**

IN-SEAT POWER
 C2X PORT W/20' CORD **+466**

See [page 7](#) for power port spec info.

Power Port Finish
 Power ports can be finished in any standard powder coat available.

5. Upholstery Style

Upholstery Style

U1 MONO-COLOR WATERLINE
 U2 DUAL-COLOR WATERLINE

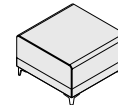
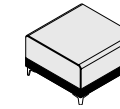
 **U1**  **U2**

When pricing models with more than one fabric, the higher grade fabric will determine the overall grade of the specific product.

6. Upholstery

Upholstery

See general information section for details on textile program and COM/COL information.

Share will develop comfort wrinkles over time. The extent of these wrinkles is determined by the fabric specified.

Share

END CAP: DOUBLE WIDE

Textile Upholstery Grades

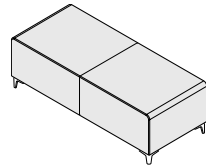
TITLE		SERIES	TYPE	SEAT	UPH	DIMENSIONS	YDG	COM	A	B	C	D	E	F	G	H	I	J	K	L	M
 End Cap, Double Wide, Lounge Height	Standard Upholstery	SH	03	46		19W x 56D x 16H	2.8	2,141	2,367	2,492	2,615	2,737	2,862	2,999	3,137	3,297	3,503	3,751	3,855	4,090	4,287
	Mono-Color Waterline	SH	03	46	U1	19W x 56D x 16H	2.4	2,398	2,592	2,697	2,806	2,911	3,018	3,136	3,251	3,389	3,569	3,780	3,867	4,069	4,237
	Dual-Color Waterline	SH	03	46	U2	19W x 56D x 16H	2 above Waterline 0.8 below Waterline	2,398	2,623	2,750	2,873	2,997	3,120	3,257	3,394	3,554	3,761	4,010	4,112	4,347	4,544
End Cap, Double Wide, Task Height	Standard Upholstery	SH	03	48		19W x 56D x 18H	2.9	2,141	2,373	2,504	2,632	2,760	2,890	3,030	3,171	3,337	3,550	3,808	3,916	4,160	4,363
	Mono-Color Waterline	SH	03	48	U1	19W x 56D x 18H	2.6	2,398	2,609	2,724	2,840	2,953	3,068	3,195	3,322	3,473	3,662	3,894	3,990	4,208	4,391
	Dual-Color Waterline	SH	03	48	U2	19W x 56D x 18H	2.2 above Waterline 0.8 below Waterline	2,398	2,643	2,774	2,907	3,040	3,173	3,318	3,464	3,639	3,859	4,124	4,235	4,487	4,697

To Order Select Below

1. Series/Type/Seat

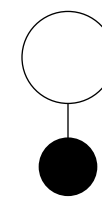

SH0346

Share
End Cap, Double Wide,
Lounge Height

SH0348

Share
End Cap, Double Wide,
Task Height

2. Leg

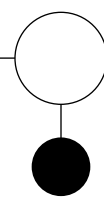

Leg

L1 CORNER LEG, ADJ. PLASTIC GLIDES

L2 ROUND LEG, ADJ. PLASTIC GLIDES

L3 WOOD LEG

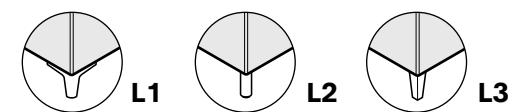

Mobility

The round leg glide has a larger diameter (1") than the corner leg for easier sliding on low pile carpet. Stylex is not responsible for damage to carpeting or floors.

3. Leg Finish

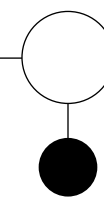

Standard Powder Coated Metal

BL BLUE

BM BLACK MATTE

BR BRASS

BT BLACK TWILIGHT

CP CHAMPAGNE

DB DARK BRONZE

DG DARK GRAY

DP DUSTY PINK

FG FOREST GREEN

LG LIGHT GRAY

MG MEADOW GREEN

MK MILK

MS METALLIC SILVER

NK NICKEL

NV NAVY

OR ORANGE

PY PALE YELLOW

RD RED

RO RED ORANGE

RR RUSTY RED

SB SOFT BLUE

SD SAND

TC TERRACOTTA

TP TAUPE

TS TEXTURED SLATE

YL YELLOW

4. Options

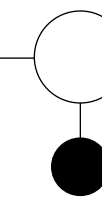

Ganging

SG GANGING **+51**

Used to connect chairs to adjacent chairs or benches.

Power

IN-SEAT POWER
C1X PORT W/10' CORD **+435**

IN-SEAT POWER
C2X PORT W/20' CORD **+466**

See [page 7](#) for power port spec info.

Power Port Finish

Power ports can be finished in any standard powder coat available.

5. Upholstery Style

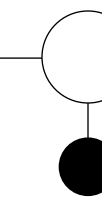

Upholstery Style

U1 MONO-COLOR WATERLINE

U2 DUAL-COLOR WATERLINE

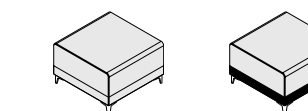

U1

U2

When pricing models with more than one fabric, the higher grade fabric will determine the overall grade of the specific product.

6. Upholstery

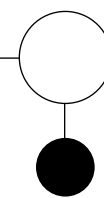

Upholstery

See general information section for details on textile program and COM/COL information.

Share will develop comfort wrinkles over time. The extent of these wrinkles is determined by the fabric specified.

Share

END CAP: DOUBLE WIDE +

Textile Upholstery Grades

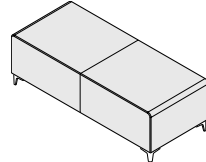
TITLE		SERIES	TYPE	SEAT	UPH	DIMENSIONS	YDG	COM	A	B	C	D	E	F	G	H	I	J	K	L	M
 End Cap, Double Wide +, Lounge Height	Standard Upholstery	SH	03	56		19W x 57D x 16H	2.9	2,213	2,449	2,578	2,707	2,833	2,963	3,105	3,246	3,411	3,627	3,882	3,988	4,232	4,435
	Mono-Color Waterline	SH	03	56	U1	19W x 57D x 16H	2.5	2,471	2,676	2,785	2,895	3,007	3,117	3,240	3,361	3,504	3,689	3,910	4,001	4,211	4,387
	Dual-Color Waterline	SH	03	56	U2	19W x 57D x 16H	2.1 above Waterline 0.9 below Waterline	2,471	2,716	2,849	2,981	3,113	3,247	3,393	3,539	3,711	3,934	4,197	4,308	4,560	4,770
End Cap, Double Wide +, Task Height	Standard Upholstery	SH	03	58		19W x 57D x 18H	3	2,213	2,456	2,590	2,723	2,857	2,987	3,136	3,280	3,450	3,674	3,940	4,050	4,302	4,512
	Mono-Color Waterline	SH	03	58	U1	19W x 57D x 18H	2.6	2,471	2,683	2,798	2,912	3,029	3,144	3,271	3,398	3,546	3,738	3,968	4,063	4,281	4,464
	Dual-Color Waterline	SH	03	58	U2	19W x 57D x 18H	2.2 above Waterline 0.9 below Waterline	2,471	2,724	2,861	2,997	3,136	3,273	3,422	3,575	3,752	3,982	4,257	4,369	4,629	4,847

To Order Select Below

1. Series/Type/Seat

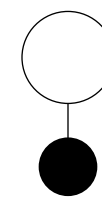

SH0356

Share
End Cap, Double Wide +, Lounge Height

SH0358

Share
End Cap, Double Wide +, Task Height

2. Leg

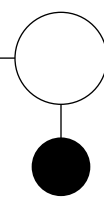

Leg

L1 CORNER LEG, ADJ. PLASTIC GLIDES

L2 ROUND LEG, ADJ. PLASTIC GLIDES

L3 WOOD LEG

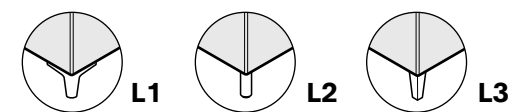

Mobility

The round leg glide has a larger diameter (1") than the corner leg for easier sliding on low pile carpet. Stylex is not responsible for damage to carpeting or floors.

3. Leg Finish

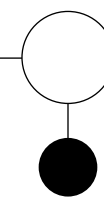

Standard Powder Coated Metal

BL BLUE

BM BLACK MATTE

BR BRASS

BT BLACK TWILIGHT

CP CHAMPAGNE

DB DARK BRONZE

DG DARK GRAY

DP DUSTY PINK

FG FOREST GREEN

LG LIGHT GRAY

MG MEADOW GREEN

MK MILK

MS METALLIC SILVER

NK NICKEL

NV NAVY

OR ORANGE

PY PALE YELLOW

RD RED

RO RED ORANGE

RR RUSTY RED

SB SOFT BLUE

SD SAND

TC TERRACOTTA

TP TAUPE

TS TEXTURED SLATE

YL YELLOW

4. Options

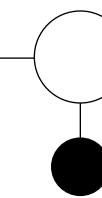

Ganging

SG GANGING **+51**

Used to connect chairs to adjacent chairs or benches.

Power

IN-SEAT POWER
C1X PORT W/10' CORD **+435**

IN-SEAT POWER
C2X PORT W/20' CORD **+466**

See [page 7](#) for power port spec info.

Power Port Finish

Power ports can be finished in any standard powder coat available.

5. Upholstery Style

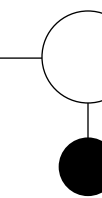

Upholstery Style

U1 MONO-COLOR WATERLINE

U2 DUAL-COLOR WATERLINE

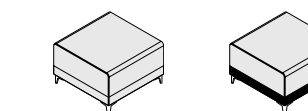

U1

U2

When pricing models with more than one fabric, the higher grade fabric will determine the overall grade of the specific product.

6. Upholstery

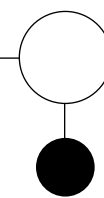

Upholstery

See general information section for details on textile program and COM/COL information.

Share will develop comfort wrinkles over time. The extent of these wrinkles is determined by the fabric specified.

Share

KNEE WALL: 24H

Textile Upholstery Grades

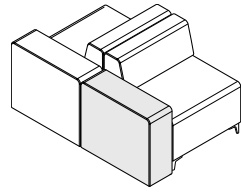
TITLE		SERIES	TYPE	SEAT	UPH	DIMENSIONS	YDG	COM	A	B	C	D	E	F	G	H	I	J	K	L	M
 Knee Wall, 24 Low	Standard Upholstery	SH	24	1		9W x 28D x 24H	1.6	1,035	1,162	1,234	1,304	1,376	1,444	1,525	1,603	1,693	1,812	1,956	2,014	2,149	2,261
	Mono-Color Waterline	SH	24	1	U1	9W x 28D x 24H	1.5	1,218	1,341	1,406	1,472	1,540	1,605	1,678	1,752	1,838	1,947	2,080	2,136	2,262	2,368
	Dual-Color Waterline	SH	24	1	U2	9W x 28D x 24H	0.9 above Waterline 0.6 below Waterline	1,218	1,341	1,406	1,472	1,540	1,605	1,678	1,752	1,838	1,947	2,080	2,136	2,262	2,368
Knee Wall, 24 Low +	Standard Upholstery	SH	24	2		9W x 28.5D x 24H	1.6	1,035	1,162	1,234	1,304	1,376	1,444	1,525	1,603	1,693	1,812	1,956	2,014	2,149	2,261
	Mono-Color Waterline	SH	24	2	U1	9W x 28.5D x 24H	1.5	1,218	1,341	1,406	1,472	1,540	1,605	1,678	1,752	1,838	1,947	2,080	2,136	2,262	2,368
	Dual-Color Waterline	SH	24	2	U2	9W x 28.5D x 24H	0.9 above Waterline 0.6 below Waterline	1,218	1,341	1,406	1,472	1,540	1,605	1,678	1,752	1,838	1,947	2,080	2,136	2,262	2,368

To Order Select Below

1. Series/Type/Seat

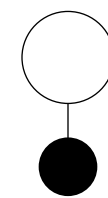

SH241

Share
Knee Wall, 24H Low

SH242

Share
Knee Wall, 24H Low +

2. Location

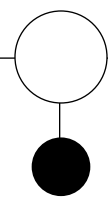

Location

L LEFT HAND

R RIGHT HAND

M MIDDLE

Knee walls include required ganging.
They must be specified left, right or middle.

Location is from the seated perspective.

3. Power Port

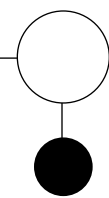

Power Port

P10 9' POWER CORD **+481**

P20 19' POWER CORD **+558**

Knee Wall Flip Out Power
Soft Touch Anodized Cover
1 Grounded 3-Prong
Electrical Outlet
1 USB 2.1A Port

4. Upholstery Style

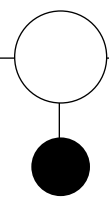

Upholstery Style

U1 MONO-COLOR WATERLINE

U2 DUAL-COLOR WATERLINE

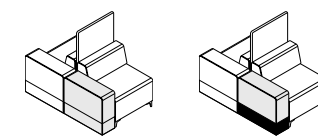

U1

U2

When pricing models with more than one fabric, the higher grade fabric will determine the overall grade of the specific product.

5. Upholstery

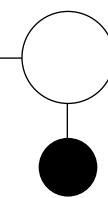

Upholstery

See general information section for details on textile program and COM/COL information.

Share will develop comfort wrinkles over time. The extent of these wrinkles is determined by the fabric specified.

Share

KNEE WALL: 29H

Textile Upholstery Grades

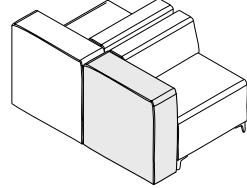
TITLE		SERIES	TYPE	SEAT	UPH	DIMENSIONS	YDG	COM	A	B	C	D	E	F	G	H	I	J	K	L	M
 Knee Wall, 29 High	Standard Upholstery	SH	29	1		9W x 28D x 29H	1.7	1,107	1,245	1,320	1,395	1,471	1,546	1,629	1,713	1,810	1,933	2,085	2,148	2,291	2,410
	Mono-Color Waterline	SH	29	1	U1	9W x 28D x 29H	2	1,290	1,455	1,542	1,632	1,718	1,808	1,904	2,003	2,117	2,265	2,442	2,514	2,682	2,823
	Dual-Color Waterline	SH	29	1	U2	9W x 28D x 29H	1.4 above Waterline 0.6 below Waterline	1,290	1,455	1,542	1,632	1,718	1,808	1,904	2,003	2,117	2,265	2,442	2,514	2,682	2,823
Knee Wall, 29 High +	Standard Upholstery	SH	29	2		9W x 28.5D x 29H	1.7	1,107	1,245	1,320	1,395	1,471	1,546	1,629	1,713	1,810	1,933	2,085	2,148	2,291	2,410
	Mono-Color Waterline	SH	29	2	U1	9W x 28.5D x 29H	2	1,290	1,455	1,542	1,632	1,718	1,808	1,904	2,003	2,117	2,265	2,442	2,514	2,682	2,823
	Dual-Color Waterline	SH	29	2	U2	9W x 28.5D x 29H	1.4 above Waterline 0.6 below Waterline	1,290	1,455	1,542	1,632	1,718	1,808	1,904	2,003	2,117	2,265	2,442	2,514	2,682	2,823

To Order Select Below

1. Series/Type/Seat

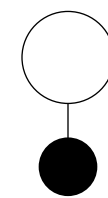

SH291

Share
Knee Wall, 29 High

SH292

Share
Knee Wall, 29 High +

2. Location

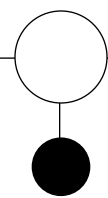

Location

L LEFT HAND
R RIGHT HAND
M MIDDLE

Knee walls include required ganging.
They must be specified left, right or middle.

Location is from the seated perspective.

3. Power Port

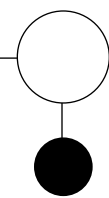

Power Port

P10 9' POWER CORD **+481**
P20 19' POWER CORD **+558**

Knee Wall Flip Out Power
Soft Touch Anodized Cover
1 Grounded 3-Prong
Electrical Outlet
1 USB 2.1A Port

4. Upholstery Style

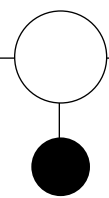

Upholstery Style

U1 MONO-COLOR WATERLINE
U2 DUAL-COLOR WATERLINE

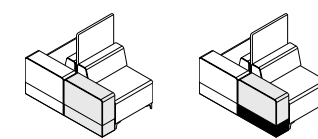

U1

U2

When pricing models with more than one fabric, the higher grade fabric will determine the overall grade of the specific product.

5. Upholstery

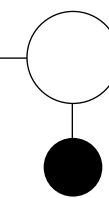

Upholstery

See general information section for details on textile program and COM/COL information.

Share will develop comfort wrinkles over time. The extent of these wrinkles is determined by the fabric specified.

Share

ARM

Textile Upholstery Grades

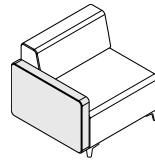
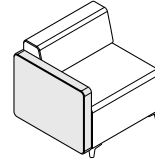
TITLE	SERIES	TYPE	SEAT	UPH	DIMENSIONS	YDG	COM	A	B	C	D	E	F	G	H	I	J	K	L	M	
	Standard Upholstery	SH	54	6	4W x 28D x 20H	2.1	429	601	694	785	879	970	1,074	1,177	1,298	1,454	1,640	1,756	1,932	2,063	
	Mono-Color Waterline	SH	54	6	U1	4W x 28D x 20H	1.8	601	750	828	907	986	1,067	1,152	1,242	1,345	1,478	1,638	1,728	1,882	1,991
	Dual-Color Waterline	SH	54	6	U2	4W x 28D x 20H	1.8 above Waterline 0.9 below Waterline	601	823	942	1,057	1,178	1,299	1,430	1,561	1,716	1,917	2,157	2,225	2,462	2,636
	Standard Upholstery	SH	56	8	4W x 28D x 22H	2.2	429	601	694	785	879	970	1,074	1,177	1,298	1,454	1,640	1,756	1,932	2,063	
	Mono-Color Waterline	SH	56	8	U1	4W x 28D x 22H	1.9	601	750	828	907	986	1,067	1,152	1,242	1,345	1,478	1,638	1,728	1,882	1,991
	Dual-Color Waterline	SH	56	8	U2	4W x 28D x 22H	1.9 above Waterline 0.9 below Waterline	601	823	942	1,057	1,178	1,299	1,430	1,561	1,716	1,917	2,157	2,225	2,462	2,636

To Order Select Below

1. Series/Type/Seat

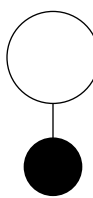

SH546

**Share
Arm, 24H**

SH568

**Share
Arm, 26H**

24H Arms are for Lounge Height Seats.
26H Arms are for Task Height Seats.

The 24H arm and 26H arm are primarily intended to be used to create club chairs, loveseats, and sofas based on the modular one, two, and three seat units.

2. Arm Location

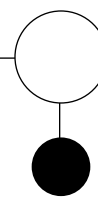

Arm Location

L LEFT HAND

R RIGHT HAND

M MID

Location is from the seated perspective.

3. Upholstery Style

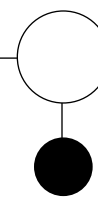

Upholstery Style

U1 MONO-COLOR WATERLINE

U2 DUAL-COLOR WATERLINE

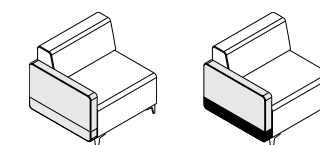

U1

U2

When pricing models with more than one fabric, the higher grade fabric will determine the overall grade of the specific product.

4. Upholstery

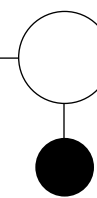

Upholstery

See general information section for details on textile program and COM/COL information.

Share will develop comfort wrinkles over time. The extent of these wrinkles is determined by the fabric specified.

Share

ROUND OTTOMAN

Textile Upholstery Grades

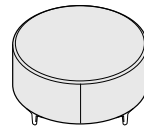
TITLE		SERIES	TYPE	SEAT	UPH	DIMENSIONS	YDG	COM	A	B	C	D	E	F	G	H	I	J	K	L	M
 Round Ottoman, Lounge Height	Standard Upholstery	SH	04	86		36D x 16H	3.4	2,809	2,831	2,986	3,138	3,296	3,455	3,628	3,799	4,004	4,268	4,581	4,709	5,005	5,310
	Mono-Color Waterline	SH	04	86	U1	36D x 16H	3.4	2,809	3,099	3,256	3,408	3,566	3,725	3,896	4,067	4,271	4,536	4,850	4,968	5,264	5,568
	Dual-Color Waterline	SH	04	86	U2	36D x 16H	2.6 above Waterline 1 below Waterline	2,809	3,115	3,282	3,444	3,610	3,776	3,960	4,143	4,359	4,638	4,970	5,101	5,417	5,737
Round Ottoman, Task Height	Standard Upholstery	SH	04	88		36D x 18H	3.6	2,809	2,921	3,088	3,249	3,416	3,584	3,765	3,949	4,162	4,444	4,776	4,913	5,230	5,550
	Mono-Color Waterline	SH	04	88	U1	36D x 18H	3.6	2,809	3,190	3,357	3,519	3,684	3,850	4,032	4,217	4,433	4,711	5,046	5,171	5,487	5,808
	Dual-Color Waterline	SH	04	88	U2	36D x 18H	2.8 above Waterline 1 below Waterline	3,556	3,880	4,055	4,225	4,402	4,577	4,771	4,964	5,190	5,486	5,837	5,951	6,285	6,624

To Order Select Below

1. Series/Type/Seat

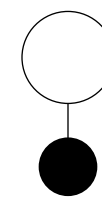

SH0486

Share Round Ottoman, Lounge Height

SH0488

Share Round Ottoman, Task Height

2. Leg

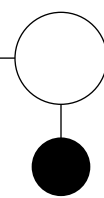

Leg

L1 CORNER LEG, ADJ. PLASTIC GLIDES

L2 ROUND LEG, ADJ. PLASTIC GLIDES

L3 WOOD LEG

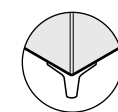

L1

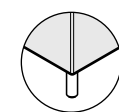

L2

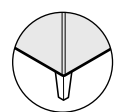

L3

Mobility

The round leg glide has a larger diameter (1") than the corner leg for easier sliding on low pile carpet. Stylex is not responsible for damage to carpeting or floors.

3. Leg Finish

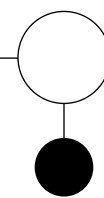

Standard Powder Coated Metal

BL BLUE

BM BLACK MATTE

BR BRASS

BT BLACK TWILIGHT

CP CHAMPAGNE

DB DARK BRONZE

DG DARK GRAY

DP DUSTY PINK

FG FOREST GREEN

LG LIGHT GRAY

MG MEADOW GREEN

MK MILK

MS METALLIC SILVER

NK NICKEL

NV NAVY

OR ORANGE

PY PALE YELLOW

RD RED

RO RED ORANGE

RR RUSTY RED

SB SOFT BLUE

SD SAND

TC TERRACOTTA

TP TAUPE

TS TEXTURED SLATE

YL YELLOW

4. Upholstery Style

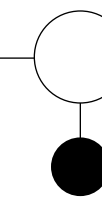

Upholstery Style

U1 MONO-COLOR WATERLINE

U2 DUAL-COLOR WATERLINE

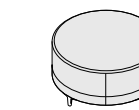

U1

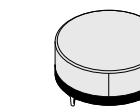

U2

When pricing models with more than one fabric, the higher grade fabric will determine the overall grade of the specific product.

5. Upholstery

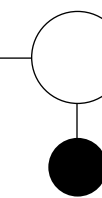

Upholstery

See general information section for details on textile program and COM/COL information.

Share will develop comfort wrinkles over time. The extent of these wrinkles is determined by the fabric specified.

Share

ACCESSORIES: CUBE SEAT

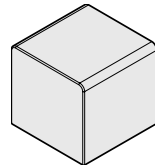
								Textile Upholstery Grades													
TITLE		SERIES	TYPE	SEAT	UPH	DIMENSIONS	YDG	COM	A	B	C	D	E	F	G	H	I	J	K	L	M
 Accessories, Cube Seat, Lounge Height	Standard Upholstery	SH	41	06		19W x 19D x 16H	1.4	885	998	1,062	1,122	1,184	1,246	1,316	1,384	1,465	1,568	1,689	1,742	1,860	1,958
	Mono-Color Waterline	SH	41	06	U1	19W x 19D x 16H	1	1,071	1,150	1,193	1,239	1,285	1,328	1,377	1,426	1,483	1,557	1,644	1,683	1,767	1,837
	Dual-Color Waterline	SH	41	06	U2	19W x 19D x 16H	1 above Waterline 0.4 below Waterline	1,071	1,182	1,245	1,309	1,371	1,432	1,500	1,568	1,649	1,752	1,874	1,928	2,046	2,144
Accessories, Cube Seat, Task Height	Standard Upholstery	SH	41	08		19W x 19D x 18H	1.5	885	1,008	1,074	1,139	1,208	1,273	1,346	1,420	1,506	1,616	1,749	1,803	1,929	2,035
	Mono-Color Waterline	SH	41	08	U1	19W x 19D x 18H	1.1	1,071	1,159	1,209	1,257	1,304	1,352	1,406	1,463	1,525	1,605	1,704	1,744	1,837	1,914
	Dual-Color Waterline	SH	41	08	U2	19W x 19D x 18H	1 above Waterline 0.4 below Waterline	1,071	1,191	1,258	1,322	1,391	1,457	1,531	1,603	1,687	1,801	1,932	1,928	2,046	2,144

To Order Select Below

1. Series/Type/Seat

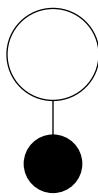

SH4106

**Share
Accessories, Cube Seat,
Lounge Height**

SH4108

**Share
Accessories, Cube Seat,
Task Height**

The light weight cube seat can be stowed along side other share pieces and easily moved as required.

2. Upholstery Style

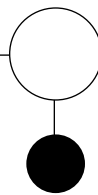

Upholstery Style

U1 MONO-COLOR WATERLINE

U2 DUAL-COLOR WATERLINE

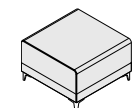

U1

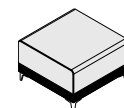

U2

When pricing models with more than one fabric, the higher grade fabric will determine the overall grade of the specific product.

3. Upholstery

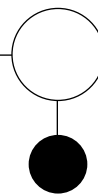

Upholstery

See general information section for details on textile program and COM/COL information.

Share will develop comfort wrinkles over time. The extent of these wrinkles is determined by the fabric specified.

Share

ACCESSORIES: PRIVACY SCREEN

Textile Upholstery Grades

TITLE	SERIES	TYPE	SEAT	UPH	DIMENSIONS	YDG	COM	A	B	C	D	E	F	G	H	I	J	K	L	M
Accessories, Privacy Screen	Standard Upholstery	SH	31	00	27W x 1.25D x 43H	1.6	739	868	938	1,010	1,080	1,150	1,229	1,309	1,399	1,516	1,658	1,718	1,853	1,965
					Overall Height: 47 Height Above Back: 18 Height Above Back on Banquette Chairs: 11															

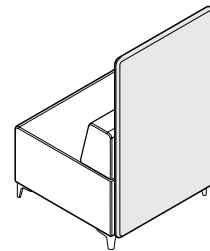

To Order Select Below

1. Series/Type/Seat/Height

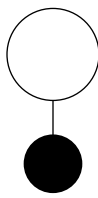

SH31006

**Share
Accessories, Privacy Screen,
Lounge Height**

SH31008

**Share
Accessories, Privacy Screen,
Task Height**

Important Information

Share privacy screens are field installed on chairs. Each seat takes one screen. Screens can be removed without damage to chair upholstery. To simplify screen installation brackets are pre-installed at the factory based on floor plans submitted with an order.

Note: Privacy screens are unavailable on curved units.

2. Upholstery Style

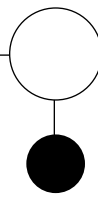

Upholstery Style

U1 MONO-COLOR WATERLINE

U2 DUAL-COLOR WATERLINE

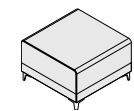

U1

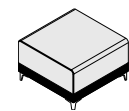

U2

When pricing models with more than one fabric, the higher grade fabric will determine the overall grade of the specific product.

3. Upholstery

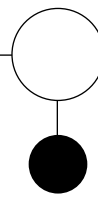

Upholstery

See general information section for details on textile program and COM/COL information.

Share will develop comfort wrinkles over time. The extent of these wrinkles is determined by the fabric specified.

stylex

Underline

PRICE LIST

Effective November 01, 2023

General Information

GENERAL INFORMATION

Terms

Net 30 days from date of invoice.
FOB Delanco, NJ

Damaged Shipments

All Stylex products are carefully inspected before they are packed in sturdy cartons designed to satisfy shipping requirements. Stylex is not responsible for damage in shipment. The transportation company assumes responsibility for delivering products to you in good condition when the bill of lading is signed. You protect yourself by refusing shipments showing damage or shortage until transportation company has noted on the delivery sheet the extent of damage or shortage. Concealed damage should be reported to the carrier as soon as discovered, but not later than 15 days after receiving shipment.

Return/Restocking Policy

Return shipments will not be accepted unless specifically authorized by Stylex in writing. The Return Authorization number should be clearly marked on the carton. The customer returning Stylex products is responsible for return shipping costs. Merchandise must be returned unused. Returned merchandise is subject to a 35% restocking fee.

Specials/Customs

Modifications to standard products will be considered for large runs. Contact Stylex for more information.

Design Changes

In keeping with modern manufacturing advances, Stylex reserves the right to incorporate minor modifications and design changes in products without notice.

Cancellation Policy

No charge prior to production except for inventory specifically requisitioned to fulfill the particular order. After production has begun, only actual costs incurred, including labor and material, will be billed to the customer.

WARRANTY

Except as provided below, Stylex warrants exclusively to the original Purchaser of our product that all parts, under normal use and service, will be free from defects in workmanship and material for a period of ten (10) years from the date of purchase. "Normal use and service" means that the product will be used in a typical office environment for 40-45 hours per week.

This warranty is subject to the following limitations, exclusions and provisions:

Wood components of plywood stacking chairs
(such as Brooks and Welcome)
5 years

Upholstery
(including mesh used for Click, F4, Insight, and Zephyr Mesh)
3 years

SAVA Mesh
10 years

COM Upholstery
No warranty
Stylex makes every effort to ensure that the COM Upholstery it approves is suitable for the intended use. Nevertheless, we will not warrant, and assume no responsibility for, the durability or tailoring quality of any COM or COL. If you have any concerns about the ultimate appearance of any covering, please order an upholstered sample.

Painted Stack Chair Frames
No Warranty
We will not warrant the finish of painted stack chair frames against damage from stacking. We recommend ordering chrome frames for chairs that will be stacked.

Felt Glides
No warranty
Due to the different surfaces on which felt glides may be used, we cannot warrant their durability over time.

If this product fails during normal use and service within the applicable warranty period (other than through normal wear and tear), please send a description of the relevant part and the nature of the defect, together with proof of purchase of the product, to Stylex at: Customer Service. c/o Stylex, P.O. Box 5038, Delanco, NJ 08075. PLEASE DO NOT RETURN PARTS OR THE PRODUCT TO STYLEX UNLESS INSTRUCTED TO DO SO BY STYLEX. Stylex will, at its option, either repair or replace the product or the part found defective by Stylex completely without charge for materials or labor. Purchaser may be required (at the option of Stylex) to return to Stylex at Purchaser's expense any defective part with all freight or shipping charges prepaid. The foregoing warranty shall be void if the product has been altered or repaired (other than by Stylex). The warranty does not cover damage to the product caused by accident, neglect, misuse, abuse, modification to the product by anyone other than Stylex or damage caused by use of the product for a purpose other than that for which it was designed. This warranty extends only to the original Purchaser of the product.

No Other Warranties

This warranty is in lieu of all other warranties, expressed or implied, including, but not limited to, implied warranties of merchantability and fitness for a particular purpose. The rights and remedies provided herein are the exclusive rights and remedies of the original purchaser of the product.

No Liability For Damages

In no event shall Stylex or its suppliers be responsible or liable for any special, indirect, consequential, or incidental damages. In no event shall the liability of Stylex exceed the actual purchase price paid to Stylex for the product.

Out of Warranty Products

For all products no longer covered by our warranty, please refer to our Design for Durability and Upgradability Policy. Contact Customer Service if you would like to purchase any replaceable components to further extend the life of any Stylex seating product. This warranty applies to all Stylex products purchased on April 13, 2018, and thereafter.

PRODUCT TAKE BACK PROGRAM

At Stylex, responsible stewardship of our products extends beyond their initial use. Our Product Take Back Program provides a practical solution for the end of our products' intended life cycle.

Through our partnership with ANEW, a 501(c)(3) nonprofit organization, we offer clients a comprehensive take-back solution for surplus office furniture and materials, regardless of their condition. ANEW's mission aligns with ours—to connect surplus resources with non-profits, public agencies, and underserved communities, minimizing landfill impact and maximizing corporate social responsibility.

By repurposing surplus items, we strengthen community networks and reduce environmental impact. Stylex proudly supports ANEW, integrating this partnership into our strategic sales strategy since 2014. Learn more at www.anewfound.org.

Initiate a Product Take Back through ANEW by emailing Stylex at info@stylexdesign.com. For additional end-of-life recovery options, refer to our Product Disassembly Instructions and End of Life Recovery Options documents, available in the Resources section of each product on our website. Together, let's build a sustainable future.

FREIGHT PROGRAM

Stylex offers a Guaranteed Freight Program, which provides the purchaser the ability to determine shipping and handling charges at the time of order. Freight charges will be calculated as a percentage of the net product price and added to the invoice at the time of shipment. The continental United States has been divided into three zones. Please use the map below to determine the freight charges for the product's destination. There is a minimum freight charge of \$150.

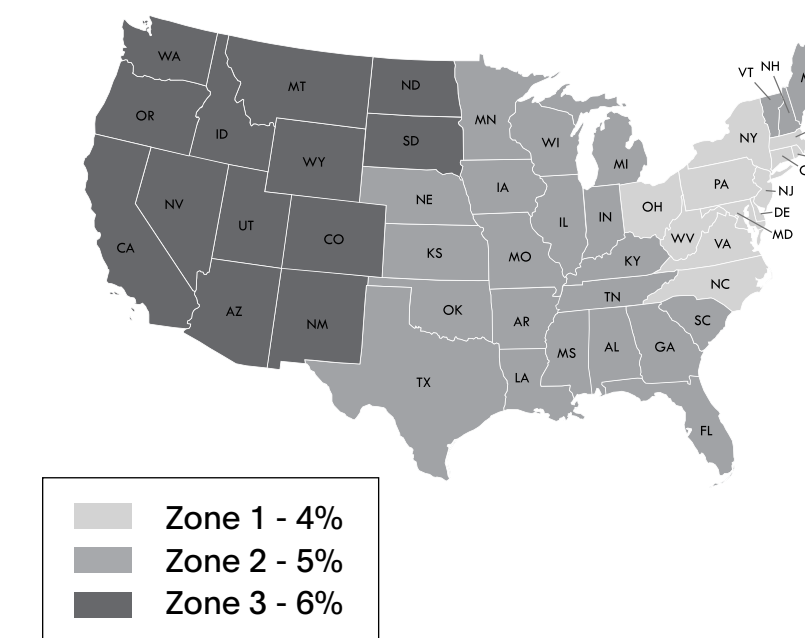

ZONE 1 - 4%

Connecticut
Delaware
New York
New Jersey
Maryland
Massachusetts
North Carolina
Ohio
Pennsylvania
Rhode Island
Virginia
Washington D.C.
West Virginia

ZONE 2 - 5%

Alabama
Arkansas
Canada, Ontario
Canada, Quebec
Florida
Georgia
Iowa
Illinois
Indiana
Kansas
Kentucky
Louisiana
Nebraska
New Hampshire
Oklahoma
Maine
Michigan
Minnesota
Mississippi
South Carolina
Tennessee
Texas
Vermont
Wisconsin

ZONE 3 - 6%

Arizona
California
Colorado
Idaho
Montana
Nevada
New Mexico
North Dakota
Oregon
South Dakota
Utah
Washington
Wyoming

Quote Per Project

Alaska
Hawaii
Canada
(outside Ontario & Quebec)
Mexico

General Information

TEXTILE PARTNERS & APPROVALS

Textile Partners

To customize your furniture performance needs and design vision, Stylex offers a wide selection of in-graded leathers and textiles from Grades A through Y. We've partnered with leading manufacturers on the options, focusing on color, price, durability, and construction. To view our partners and explore our digital carded program with broadly approved textiles, visit [this page](#). We stand by these textiles: They're tried and tested, and will effortlessly fit into any design aesthetic.

Textile Approvals

To view Stylex Approved Textile documents to determine specific product approval status, refer to our Product Tested Textiles documents, available in the Resources section of each product on our website.

CAL 117 AND 133 COMPLIANCE

CAL 117-2013

All Stylex seating satisfies the requirements of CAL 117-2013 so long as one of our standard or in-graded textiles is applied. COM textiles cannot be so guaranteed. Please contact the supplier of COM's directly to determine the fire retardancy of any COM supplied to us.

CAL 133

Most Stylex seating can be ordered to meet the requirements of CAL 133. When ordering, simply specify "CAL 133 compliance required". The upcharge for this option is \$54 list per yard. Please refer to the COM yardage of each model to determine the number of yards required. We do frequently require full-scale burn tests in order to certify CAL 133 before an order will be accepted. Such burn tests may increase normal lead times and do carry additional charges. Please contact customer service for details.

CUSTOMER'S OWN MATERIAL/LEATHER

Customer's own material (COM) and customer's own leather (COL) will generally be upholstered at the price designated in each product's price list. Please be advised, however, that we specifically reserve the right to charge a higher price when we determine that special circumstances, such as unusual repeats or challenging materials, present themselves. All orders for custom coverings must be approved by Stylex before they will be accepted for production. To submit proposed textile for approval, please use the COM form [here](#).

Special Note:

We assume no responsibility for the durability or tailoring quality of any COM or COL. Directional covers in particular may not meet your satisfaction due to the design of certain products. Please be advised that COM and COL orders are not subject to return. If you have doubts about the ultimate appearance of certain coverings, please order a sample done with that specific COM or COL. In addition, while we inspect textiles for mill imperfections, some are difficult to recognize. We cannot be responsible for defects, color inaccuracies, dye lot variations, or other flaws.

Under no circumstances will we be responsible for COM shortages, flaws, or other such problems. Finally, it is not our responsibility to police the receipt of COM's in order to meet delivery deadlines, and we assume our customers are aware of any undue delay in the shipment of their COM textiles.

COM textile and COL leather should be sent prepaid to: Stylex

**Attn: COM/COL - [Your PO #]
740 Coopertown Road
Delanco, NJ 08075**

Clearly mark textile or leather with the dealer's name, purchase order number, and furniture model number of the item to be covered. Actual furniture orders should include the same information, as well as a description of the textile or leather, including pattern and color number, in order to provide a cross reference.

Yardage requirements shown in the price list are based on non-directional goods of 54" width. Textiles less than 54" wide or those requiring matching (stripes, prints, or large patterned designs) call for additional yardage. We will be happy to supply yardage requirements for large quantities where economies may be realized.

Add the following yardage for stripes, plaids, or patterns with repeats:

Textile Width	Plain Textile	2-14" Repeat	15-24" Repeat	25-27" Repeat	28-36" Repeat
54"	0%	10%	15%	20%	25%
50"	10%	20%	25%	30%	35%
48"	15%	25%	30%	35%	40%
45"	40%	50%	55%	60%	65%
36"	50%	60%	65%	70%	75%

COM/COL FORM

To avoid delay in processing COM orders we request that you submit a sample of your COM textile stapled to this form which can be downloaded [here](#). If a textile has a stripe or design, the size of the repeat should be indicated. Please indicate the textile supplier's name, textile number, and color. Also indicate the Stylex product on which the textile will be used.

The textile supplier must indicate on his shipping labels the dealer name and purchase order number as well as the Stylex model number.

Please Note:

No order may be entered into production or have a shipping date assigned until all related COM is received at the factory.



CENTER OF STRIPE OR DESIGN

TOP	TOP
-----	-----

1. Size of Repeat

2. Textile Supplier

3. Textile Number

4. Color

5. Stylex Product

Underline

Contents

<hr/>		<hr/>	
COLORS, MATERIALS, AND FINISHES	5	CHAIR: ARMLESS	9
<hr/>		<hr/>	
STATEMENT OF LINE	6	CHAIR: ARM	10
<hr/>		<hr/>	
DIMENSIONS	7	STOOL: COUNTER	11
<hr/>		<hr/>	
HOW TO ORDER	8	STOOL: BAR	12
<hr/>		<hr/>	

CLICK THE TITLES ABOVE TO NAVIGATE THROUGH THE DOCUMENT
PRODUCT HEADERS ON SUBSEQUENT PAGES LINK BACK TO THIS PAGE

Underline

COLORS, MATERIALS, AND FINISHES

POWDER COATED PAINTED METAL

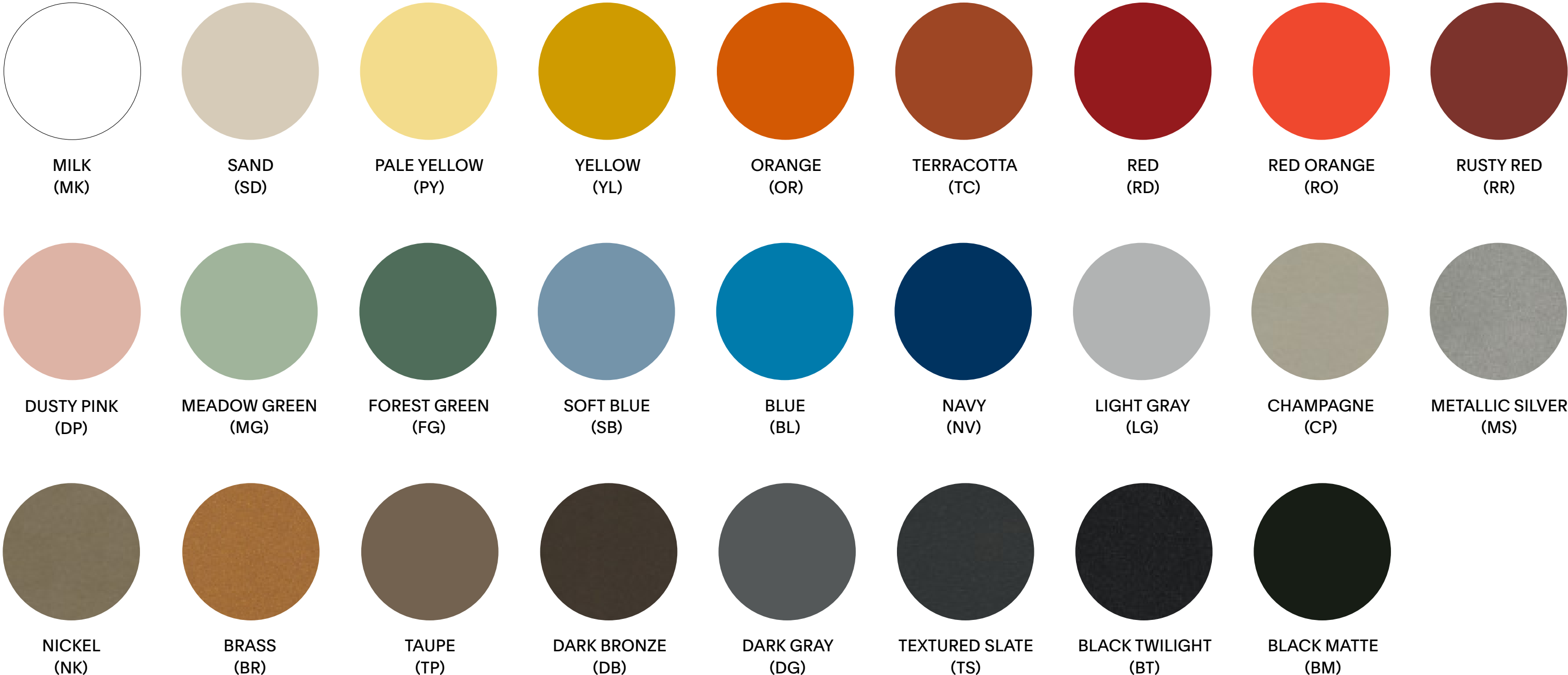

POLISHED METAL



WOOD FINISH



Underline

SPECIFICATION GUIDE: STATEMENT OF LINE

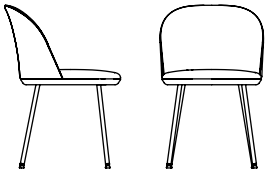
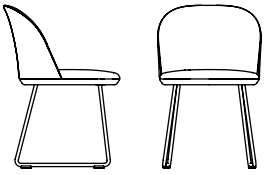
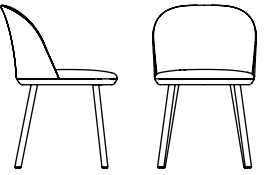
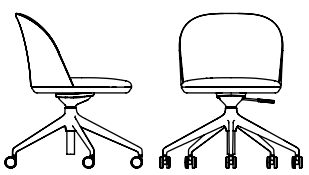
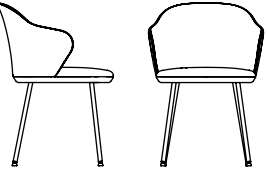
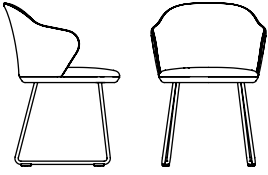
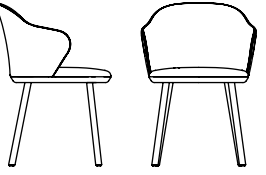
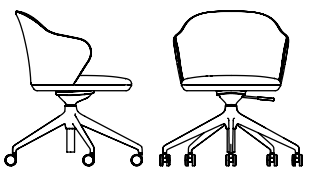
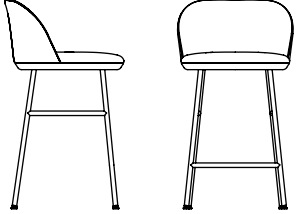
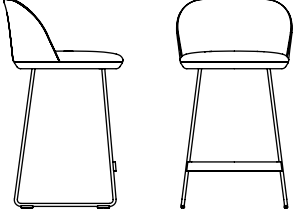
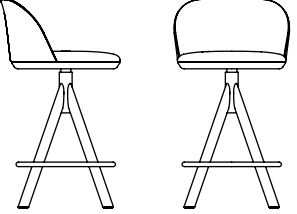
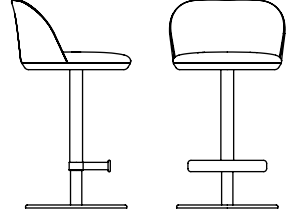
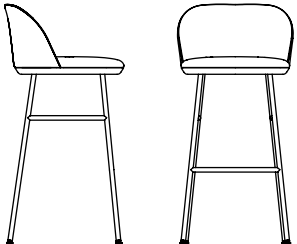
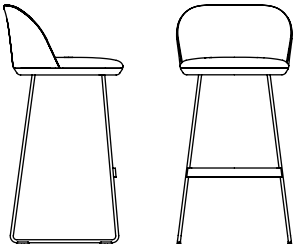
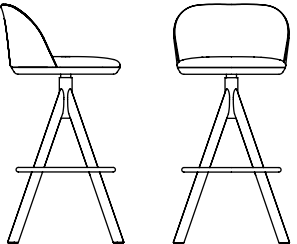
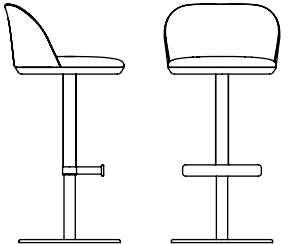
OVERVIEW	FOUR LEG METAL	SLED METAL	WOOD	SWIVEL METAL
Chair, Armless			Four Leg Wood 	5-Blade 
Chair, Arms			Four Leg Wood 	5-Blade 
Counter Stool			Swivel Wood 	Swivel Pedestal 
Bar Stool			Swivel Wood 	Swivel Pedestal 

OPTIONS

Contrasting Thread

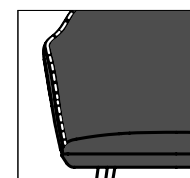

Dual Upholstered
Seat and Back

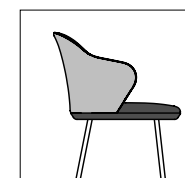

PRODUCT INFORMATION

Design
LucidiPevere

Construction
Upholstered elements are constructed with plastic and molded polyurethane foam for comfort. Internal back structures are molded with 100% recycled material.

Carriages and other aluminum components are made from recyclable aluminum. Sled and Four Leg metal bases are made from steel tubing. Chair Wood Four Leg bases are attached to the carriage using steel brackets. Stool Wood Swivel bases are attached to an aluminum, return-to-center swivel hub. A steel ring is used as a footrest.

Finishes
All metal components are available in all Stylex powder coat colors. In addition, Aluminum components are offered with a polished finish; Steel components are chromed to match. Aluminum carriages and frames will be produced with matching finishes.

Casters
Casters are available in black, gray, and white. For Five-Blade chairs, cylinders and lever handles are color matched to the caster color selected. When Polished Aluminum is the frame choice, the chair is shipped with a chrome cylinder regardless of caster color chosen.

Glides
Glides are available in black or gray, and are either plastic or plastic with felt pads.

Ganging
Not Available

Use
Designed for indoor use only.

Performance Standards
Manufactured to comply with:
ANSI/BIFMA X5.1 General-Purpose Office Chairs - Tests

Environment
Greenguard Gold
LEVEL® 1

Underline

SPECIFICATION GUIDE: DIMENSIONS

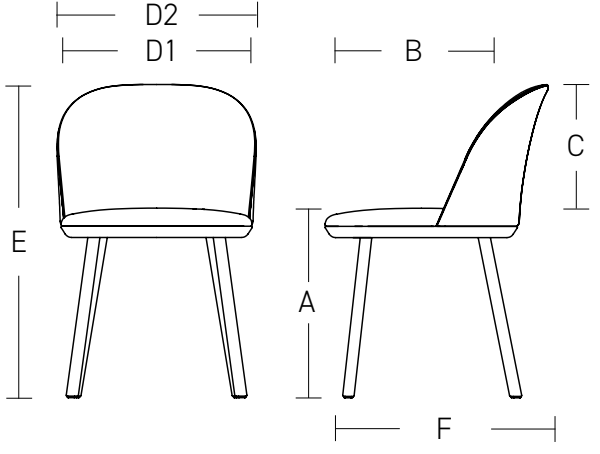
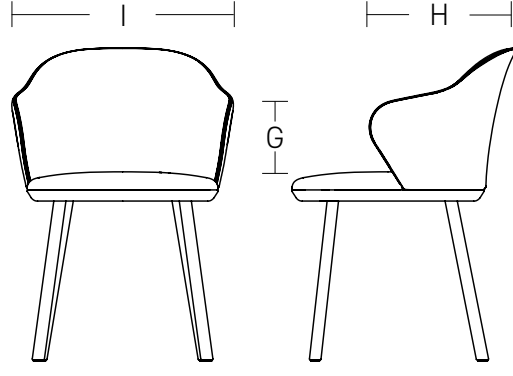
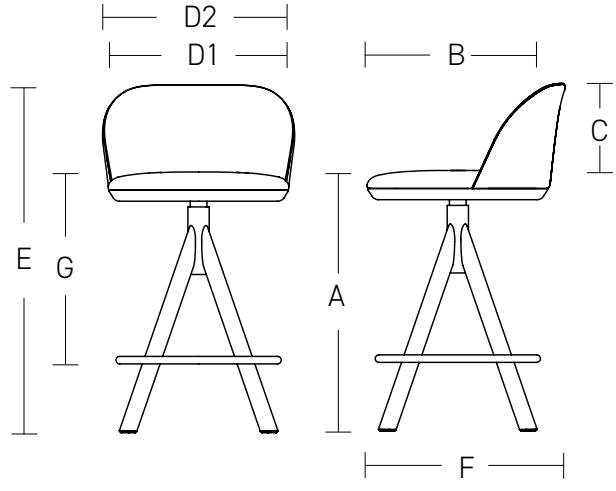
OVERVIEW	FOUR LEG METAL	SLED METAL	WOOD	SWIVEL METAL
<p>Dimensions</p> <ul style="list-style-type: none"> A. Sit Height B. Seat Depth C. Back Height D1. Seat Width D2. Overall Width E. Overall Height F. Overall Depth G. Arm Height (Chair) Footrail from Seat Height (Stool) H. Arm Depth I. Distance Between Arms <p>All measurements provided are taken using a BIFMA ISO Chair Measuring Device.</p>   	<p>Armless Chair</p> <ul style="list-style-type: none"> A. 18 B. 18 C. 13.25 D1. 19 D2. 19.9 E. 31.25 F. 22.25 	<p>Armless Chair</p> <ul style="list-style-type: none"> A. 18 B. 18 C. 13.25 D1. 19 D2. 19.9 E. 31.25 F. 22.25 	<p>Armless Chair, Four Leg Wood</p> <ul style="list-style-type: none"> A. 18 B. 18 C. 13.25 D1. 19 D2. 19.9 E. 31.25 F. 22.25 	<p>Armless Chair, 5-Blade</p> <ul style="list-style-type: none"> A. 16.9 - 21.9 B. 18 C. 13.25 D1. 19 D2. 29 E. 29.5 - 34.5 F. 29
	<p>Arm Chair</p> <ul style="list-style-type: none"> A. 18 B. 18 C. 13.25 D1. 19 D2. 19.9 E. 31.25 F. 22.25 G. 8 H. 10.2 I. 17.5 	<p>Arm Chair</p> <ul style="list-style-type: none"> A. 18 B. 18 C. 13.25 D1. 19 D2. 19.9 E. 31.25 F. 22.25 G. 8 H. 10.2 I. 17.5 	<p>Arm Chair, Four Leg Wood</p> <ul style="list-style-type: none"> A. 18 B. 18 C. 13.25 D1. 19 D2. 19.9 E. 31.25 F. 22.25 G. 8 H. 10.2 I. 17.5 	<p>Arm Chair, 5-Blade</p> <ul style="list-style-type: none"> A. 18 - 23.5 B. 18 C. 13.25 D1. 19 D2. 29 E. 30 - 35 F. 29 G. 8 H. 10.2 I. 17.5
	<p>Counter Stool</p> <ul style="list-style-type: none"> A. 25.5 B. 16.6 C. 9 D1. 18 D2. 19.2 E. 34.5 F. 19.6 G. 17.9 	<p>Counter Stool</p> <ul style="list-style-type: none"> A. 25.5 B. 16.6 C. 9 D1. 18 D2. 19.2 E. 34.5 F. 19.6 G. 17.9 	<p>Counter Stool, Swivel Wood</p> <ul style="list-style-type: none"> A. 25.5 B. 16.6 C. 9 D1. 18 D2. 19.2 E. 34.5 F. 19.6 G. 17.9 	<p>Counter Stool, Swivel Pedestal</p> <ul style="list-style-type: none"> A. 25.5 B. 16.6 C. 9 D1. 18 D2. 19.2 E. 34.5 F. 19.6 G. 17.9
	<p>Bar Stool</p> <ul style="list-style-type: none"> A. 30.5 B. 16.6 C. 9 D1. 18 D2. 19.2 E. 39.5 F. 19.6 G. 17.9 	<p>Bar Stool</p> <ul style="list-style-type: none"> A. 30.5 B. 16.6 C. 9 D1. 18 D2. 19.2 E. 39.5 F. 19.6 G. 17.9 	<p>Bar Stool, Swivel Wood</p> <ul style="list-style-type: none"> A. 30.5 B. 16.6 C. 9 D1. 18 D2. 19.2 E. 39.5 F. 19.6 G. 17.9 	<p>Bar Stool, Swivel Pedestal</p> <ul style="list-style-type: none"> A. 30.5 B. 16.6 C. 9 D1. 18 D2. 19.2 E. 39.5 F. 19.6 G. 17.9

Underline

SPECIFICATION GUIDE: HOW TO ORDER

MODEL CODE BREAKDOWN

Sample Model Code: **UL1210DFPG1BMCOM**

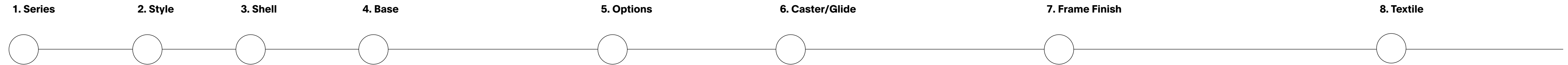



UL **1** **2** **10** **DF** **PG1** **BM** **COM**

1. Series	2. Style	3. Shell	4. Base	5. Options	6. Caster/Glide	7. Frame Finish	8. Textile	
Series UL UNDERLINE	Style 1 CHAIR 2 STOOL	Shell 1 ARMLESS 2 ARM 5 LOW BACK	Base 10 CHAIR, FOUR LEG METAL 11 CHAIR, SLED METAL 12 CHAIR, FOUR LEG WOOD 50 CHAIR, 5-BLADE 20 COUNTER STOOL, FOUR LEG METAL 21 COUNTER STOOL, SLED 22 COUNTER STOOL, SWIVEL WOOD 23 COUNTER STOOL, SWIVEL PEDESTAL 30 BAR STOOL, FOUR LEG METAL 31 BAR STOOL, SLED 32 BAR STOOL, SWIVEL WOOD 33 BAR STOOL, SWIVEL PEDESTAL	Options DF DUAL UPHOLSTERY CT CONTRASTING THREAD	Casters with Hard Wheels C1 HARD, BLACK C2 HARD, MILK WITH LIGHT GRAY TIRE C3 HARD, LIGHT GRAY Casters with Soft Wheels CS1 SOFT, BLACK CS2 SOFT, MILK WITH LIGHT GRAY TIRE CS3 SOFT, LIGHT GRAY Glides PG1 PLASTIC GLIDE LIGHT GRAY PG2 PLASTIC GLIDE BLACK FG1 PLASTIC GLIDE LIGHT GRAY WITH FELT PAD FG2 PLASTIC GLIDE BLACK WITH FELT PAD PG PLASTIC NAIL GLIDE FG FELT NAIL GLIDE	Standard Powder Coated Metal BL BLUE BM BLACK MATTE BR BRASS BT BLACK TWILIGHT CP CHAMPAGNE DB DARK BRONZE DG DARK GRAY DP DUSTY PINK FG FOREST GREEN LG LIGHT GRAY MG MEADOW GREEN MK MILK MS METALLIC SILVER NK NICKEL NV NAVY OR ORANGE PY PALE YELLOW RD RED RO RED ORANGE RR RUSTY RED SB SOFT BLUE SD SAND TC TERRACOTTA TP TAUPE TS TEXTURED SLATE YL YELLOW Polished Metal AL POLISHED ALUMINUM	Wood Finish 81 WHITE OAK 83 MAPLE 85 WALNUT 87 OPAQUE BLACK	Textile Grades COM CUSTOMER'S OWN MATERIAL A GRADE A B GRADE B C GRADE C D GRADE D E GRADE E F GRADE F G GRADE G H GRADE H I GRADE I J GRADE J K GRADE K L GRADE L M GRADE M Leather Grades COL CUSTOMER'S OWN LEATHER W GRADE W X GRADE X Y GRADE Y E1 GRADE E1 E2 GRADE E2 Note: Select highest grade in the case of dual upholstery

Underline

CHAIR: ARMLESS

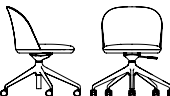
TITLE	SERIES	STYLE	SHELL	BASE	DIMENSIONS	YDG	COL	Textile Upholstery Grades													Leather Upholstery Grades					
								COM	COL	COM	A	B	C	D	E	F	G	H	I	J	K	L	M	W	X	Y
Chair, Armless, Four Leg Metal Base 	UL	1	1	10	20W x 22.25D x 31.25H	1.4	16	846	987	1,064	1,139	1,216	1,294	1,377	1,461	1,560	1,687	1,842	1,994	2,148	2,301	1,159	1,268	1,617	1,839	2,059
Chair, Armless, Sled Metal Frame 	UL	1	1	11	20W x 22.25D x 31.25H	1.4	16	896	1,036	1,113	1,189	1,265	1,343	1,426	1,510	1,610	1,737	1,891	2,043	2,198	2,350	1,209	1,318	1,666	1,888	2,108
Chair, Armless, Four Leg Wood Base 	UL	1	1	12	20W x 22.25D x 31.25H	1.4	16	1,019	1,159	1,236	1,311	1,388	1,466	1,549	1,633	1,733	1,860	2,014	2,166	2,321	2,473	1,331	1,441	1,789	2,011	2,231
Chair, Armless, 5 Blade Base 	UL	1	1	50	29W x 29D x 29.5 - 34.5H	1.4	16	970	1,111	1,188	1,263	1,340	1,418	1,500	1,584	1,684	1,811	1,966	2,118	2,272	2,424	1,283	1,392	1,741	1,962	2,183

To Order Select Below

1. Series/Style/Shell

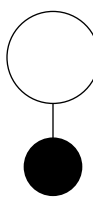

UL11

Underline Chair, Armless

2. Base

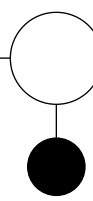

Base

10 CHAIR, FOUR LEG METAL

11 CHAIR, SLED METAL

12 CHAIR, FOUR LEG WOOD

50 CHAIR, 5-BLADE

3. Options

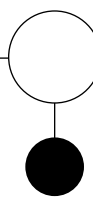

Options

DF DUAL UPHOLSTERY

CT CONTRASTING THREAD

4. Caster/Glide

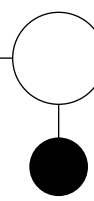

Casters with Hard Wheels

C1 HARD, BLACK

C2 HARD, MILK W/ LIGHT GRAY TIRE **+4**

C3 HARD, LIGHT GRAY **+3**

Casters with Soft Wheels

CS1 SOFT, BLACK **+9**

CS2 SOFT, MILK W/ LIGHT GRAY TIRE **+16**

CS3 SOFT, LIGHT GRAY **+15**

Glides

PG1 PLASTIC GLIDE LIGHT GRAY

PG2 PLASTIC GLIDE BLACK

FG1 PLASTIC GLIDE LIGHT GRAY WITH FELT PAD

FG2 PLASTIC GLIDE BLACK WITH FELT PAD

PG PLASTIC NAIL GLIDE

FG FELT NAIL GLIDE

5. Frame Finish

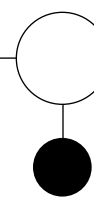

Standard Powder Coated Metal

BL BLUE

BM BLACK MATTE

BR BRASS

BT BLACK TWILIGHT

CP CHAMPAGNE

DB DARK BRONZE

DG DARK GRAY

DP DUSTY PINK

FG FOREST GREEN

LG LIGHT GRAY

MG MEADOW GREEN

MK MILK

MS METALLIC SILVER

Polished Metal

AL POLISHED ALUMINUM

NK NICKEL

NV NAVY

OR ORANGE

PY PALE YELLOW

RD RED

RO RED ORANGE

RR RUSTY RED

SB SOFT BLUE

SD SAND

TC TERRACOTTA

TP TAUPE

TS TEXTURED SLATE

YL YELLOW

Wood Finish

81 WHITE OAK **+29**

83 MAPLE

85 WALNUT **+63**

87 OPAQUE BLACK **+59**

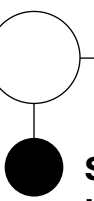

6. Upholstery



See general information section for details on textile program and COM/COL information.

Underline

CHAIR: ARM

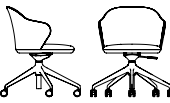
TITLE	SERIES	STYLE	SHELL	BASE	DIMENSIONS	COM	COL	Textile Upholstery Grades												Leather Upholstery Grades						
								YDG	SQFT	COM	A	B	C	D	E	F	G	H	I	J	K	L	M	W	X	Y
Chair, Arm, Four Leg Metal Base 	UL	1	2	10	20W x 22.25D x 31.25H	1.4	18	953	1,112	1,198	1,282	1,369	1,456	1,551	1,645	1,757	1,901	2,074	2,245	2,418	2,589	1,310	1,436	1,833	2,087	2,339
Chair, Arm, Sled Metal Frame 	UL	1	2	11	20W x 22.25D x 31.25H	1.4	18	1,004	1,162	1,248	1,332	1,420	1,507	1,601	1,696	1,807	1,951	2,124	2,295	2,469	2,640	1,361	1,487	1,884	2,138	2,390
Chair, Arm, Four Leg Wood Base 	UL	1	2	12	20W x 22.25D x 31.25H	1.4	18	1,126	1,284	1,370	1,454	1,541	1,629	1,723	1,818	1,929	2,073	2,246	2,417	2,590	2,762	1,483	1,609	2,006	2,260	2,512
Chair, Arm, 5 Blade Base 	UL	1	2	50	29W x 29D x 30 - 35H	1.4	18	1,077	1,236	1,322	1,406	1,493	1,580	1,675	1,769	1,881	2,024	2,198	2,369	2,542	2,713	1,434	1,560	1,957	2,211	2,463

To Order Select Below

1. Series/Style/Shell

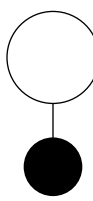

UL12

Underline Chair, Arm

2. Base

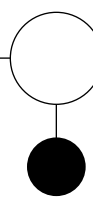

Base

10 CHAIR, FOUR LEG METAL

11 CHAIR, SLED METAL

12 CHAIR, FOUR LEG WOOD

50 CHAIR, 5-BLADE

3. Options

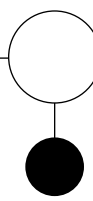

Options

DF DUAL UPHOLSTERY

CT CONTRASTING THREAD

4. Caster/Glide

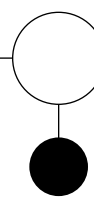

Casters with Hard Wheels

C1 HARD, BLACK

C2 HARD, MILK W/ LIGHT GRAY TIRE **+4**

C3 HARD, LIGHT GRAY **+3**

Casters with Soft Wheels

CS1 SOFT, BLACK **+9**

CS2 SOFT, MILK W/ LIGHT GRAY TIRE **+16**

CS3 SOFT, LIGHT GRAY **+15**

Glides

PG1 PLASTIC GLIDE LIGHT GRAY

PG2 PLASTIC GLIDE BLACK

FG1 PLASTIC GLIDE LIGHT GRAY WITH FELT PAD

FG2 PLASTIC GLIDE BLACK WITH FELT PAD

PG PLASTIC NAIL GLIDE

FG FELT NAIL GLIDE

5. Frame Finish

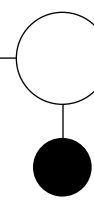

Standard Powder Coated Metal

BL BLUE

BM BLACK MATTE

BR BRASS

BT BLACK TWILIGHT

CP CHAMPAGNE

DB DARK BRONZE

DG DARK GRAY

DP DUSTY PINK

FG FOREST GREEN

LG LIGHT GRAY

MG MEADOW GREEN

MK MILK

MS METALLIC SILVER

NK NICKEL

NV NAVY

OR ORANGE

PY PALE YELLOW

RD RED

RO RED ORANGE

RR RUSTY RED

SB SOFT BLUE

SD SAND

TC TERRACOTTA

TP TAUPE

TS TEXTURED SLATE

YL YELLOW

Polished Metal

AL POLISHED ALUMINUM

6. Upholstery

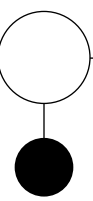

See general information section for details on textile program and COM/COL information.

Wood Finish

81 WHITE OAK **+29**

83 MAPLE

85 WALNUT **+63**

87 OPAQUE BLACK **+59**

Underline

STOOL: COUNTER

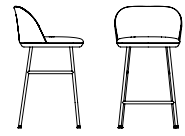
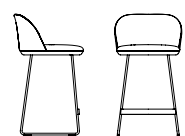
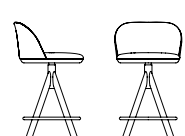
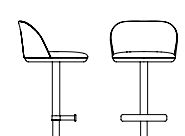
TITLE	SERIES	STYLE	SHELL	BASE	DIMENSIONS	YDG	SQFT	Textile Upholstery Grades													Leather Upholstery Grades					
								COM	COL	COM	A	B	C	D	E	F	G	H	I	J	K	L	M	W	X	Y
Stool, Low Back, Counter Four Leg Metal Base 	UL	2	5	20	19.2W x 19.6D x 34.5H	1.1	14	899	1,022	1,089	1,155	1,222	1,289	1,363	1,436	1,524	1,635	1,770	1,903	2,038	2,170	1,167	1,261	1,559	1,749	1,938
Stool, Low Back, Counter Sled Frame 	UL	2	5	21	19.2W x 19.6D x 34.5H	1.1	14	864	987	1,054	1,120	1,188	1,255	1,328	1,402	1,489	1,600	1,736	1,868	2,003	2,136	1,132	1,226	1,525	1,715	1,904
Stool, Low Back, Counter Swivel Wood Base 	UL	2	5	22	19.2W x 19.6D x 34.5H	1.1	14	1,280	1,403	1,470	1,536	1,603	1,671	1,744	1,818	1,905	2,016	2,151	2,284	2,419	2,552	1,548	1,642	1,940	2,130	2,319
Stool, Low Back, Counter Swivel Pedestal Base 	UL	2	5	23	19.2W x 19.6D x 34.5H	1.1	14	1,717	1,840	1,907	1,973	2,040	2,107	2,181	2,254	2,342	2,453	2,588	2,721	2,856	2,988	1,985	2,079	2,377	2,567	2,756

To Order Select Below

1. Series/Style/Shell

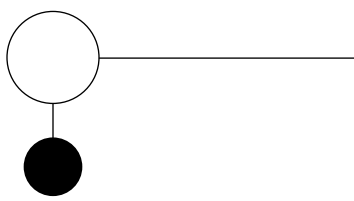

UL25
Underline Stool, Low Back

2. Base

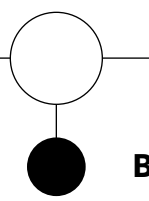

Base

20 COUNTER STOOL, FOUR LEG METAL

21 COUNTER STOOL, SLED

22 COUNTER STOOL, SWIVEL WOOD BASE

23 COUNTER STOOL, SWIVEL PEDESTAL

3. Options

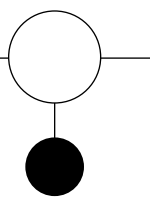

Options

DF DUAL UPHOLSTERY

CT CONTRASTING THREAD

4. Caster/Glide

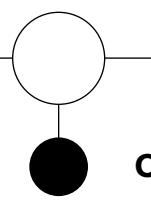

Casters with Hard Wheels

C1 HARD, BLACK

C2 HARD, MILK W/ LIGHT GRAY TIRE **+4**

C3 HARD, LIGHT GRAY **+3**

Casters with Soft Wheels

CS1 SOFT, BLACK **+9**

CS2 SOFT, MILK W/ LIGHT GRAY TIRE **+16**

CS3 SOFT, LIGHT GRAY **+15**

Glides

PG1 PLASTIC GLIDE LIGHT GRAY

PG2 PLASTIC GLIDE BLACK

FG1 PLASTIC GLIDE LIGHT GRAY WITH FELT PAD

FG2 PLASTIC GLIDE BLACK WITH FELT PAD

PG PLASTIC NAIL GLIDE

FG FELT NAIL GLIDE

5. Frame Finish

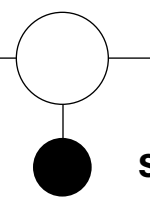

Standard Powder Coated Metal

BL BLUE

BM BLACK MATTE

BR BRASS

BT BLACK TWILIGHT

CP CHAMPAGNE

DB DARK BRONZE

DG DARK GRAY

DP DUSTY PINK

FG FOREST GREEN

LG LIGHT GRAY

MG MEADOW GREEN

MK MILK

MS METALLIC SILVER

NK NICKEL

NV NAVY

OR ORANGE

PY PALE YELLOW

RD RED

RO RED ORANGE

RR RUSTY RED

SB SOFT BLUE

SD SAND

TC TERRACOTTA

TP TAUPE

TS TEXTURED SLATE

YL YELLOW

Polished Metal

AL POLISHED ALUMINUM

6. Upholstery

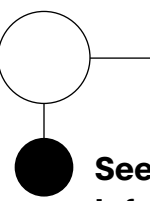

See general information section for details on textile program and COM/COL information.

Wood Finish

83 MAPLE

81 WHITE OAK **+59**

87 OPAQUE BLACK **+59**

Walnut is not available on stools.

AL is unavailable for the Stool Swivel Wood and Swivel Pedestal models.

Underline

STOOL: BAR

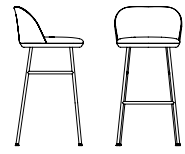
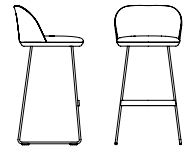
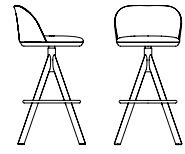
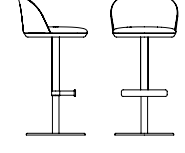
TITLE	SERIES	STYLE	SHELL	BASE	DIMENSIONS	COM	COL	Textile Upholstery Grades													Leather Upholstery Grades					
								YDG	SQFT	COM	A	B	C	D	E	F	G	H	I	J	K	L	M	W	X	Y
Stool, Low Back, Bar Four Leg Metal Base 	UL	2	5	30	19.2W x 19.6D x 39.5H	1.1	14	903	1,026	1,093	1,159	1,226	1,294	1,367	1,441	1,528	1,639	1,775	1,907	2,042	2,175	1,171	1,265	1,563	1,754	1,943
Stool, Low Back, Bar Sled Frame 	UL	2	5	31	19.2W x 19.6D x 39.5H	1.1	14	880	1,003	1,070	1,136	1,203	1,271	1,344	1,418	1,505	1,616	1,751	1,884	2,019	2,151	1,148	1,242	1,540	1,730	1,919
Stool, Low Back, Bar Swivel Wood Base 	UL	2	5	32	19.2W x 19.6D x 39.5H	1.1	14	1,303	1,426	1,493	1,559	1,626	1,694	1,767	1,841	1,928	2,039	2,175	2,307	2,442	2,575	1,571	1,665	1,964	2,154	2,343
Stool, Low Back, Bar Swivel Pedestal Base 	UL	2	5	33	19.2W x 19.6D x 39.5H	1.1	14	1,733	1,855	1,923	1,989	2,056	2,123	2,197	2,270	2,357	2,469	2,604	2,736	2,872	3,004	2,000	2,095	2,393	2,583	2,772

To Order Select Below

1. Series/Style/Shell

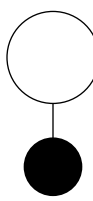

UL25

Underline Stool, Low Back

2. Base

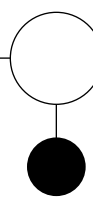

Base

30 BAR STOOL, FOUR LEG METAL

31 BAR STOOL, SLED

32 BAR STOOL, SWIVEL WOOD BASE

33 BAR STOOL, SWIVEL PEDESTAL

3. Options

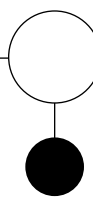

Options

DF DUAL UPHOLSTERY

CT CONTRASTING THREAD

4. Caster/Glide

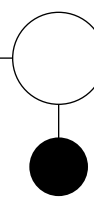

Casters with Hard Wheels

C1 HARD, BLACK

C2 HARD, MILK W/ LIGHT GRAY TIRE **+4**

C3 HARD, LIGHT GRAY **+3**

Casters with Soft Wheels

CS1 SOFT, BLACK **+9**

CS2 SOFT, MILK W/ LIGHT GRAY TIRE **+16**

CS3 SOFT, LIGHT GRAY **+15**



Glides

PG1 PLASTIC GLIDE LIGHT GRAY

PG2 PLASTIC GLIDE BLACK

FG1 PLASTIC GLIDE LIGHT GRAY WITH FELT PAD

FG2 PLASTIC GLIDE BLACK WITH FELT PAD

PG PLASTIC NAIL GLIDE

FG FELT NAIL GLIDE

5. Frame Finish

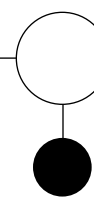

Standard Powder Coated Metal

BL BLUE

BM BLACK MATTE

BR BRASS

BT BLACK TWILIGHT

CP CHAMPAGNE

DB DARK BRONZE

DG DARK GRAY

DP DUSTY PINK

FG FOREST GREEN

LG LIGHT GRAY

MG MEADOW GREEN

MK MILK

MS METALLIC SILVER



Polished Metal

AL POLISHED ALUMINUM

NK NICKEL

NV NAVY

OR ORANGE

PY PALE YELLOW

RD RED

RO RED ORANGE

RR RUSTY RED

SB SOFT BLUE

SD SAND

TC TERRACOTTA

TP TAUPE

TS TEXTURED SLATE

YL YELLOW

6. Upholstery

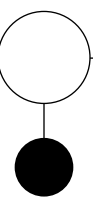

See general information section for details on textile program and COM/COL information.



Wood Finish

83 MAPLE

81 WHITE OAK **+48**

87 OPAQUE BLACK **+59**

Walnut is not available on stools.

AL is unavailable for the Stool Swivel Wood and Swivel Pedestal models.

stylex

Verve

PRICE LIST

Effective November 01, 2023

General Information

GENERAL INFORMATION

Terms

Net 30 days from date of invoice,
F. O. B . Delanco, New Jersey.

Damaged Shipments

All Stylex products are carefully inspected before they are packed in sturdy cartons designed to satisfy shipping requirements. Stylex is not responsible for damage in shipment. The transportation company assumes responsibility for delivering products to you in good condition when the bill of lading is signed. You protect yourself by refusing shipments showing damage or shortage until transportation company has noted on the delivery sheet the extent of damage or shortage. Concealed damage should be reported to the carrier as soon as discovered, but not later than 15 days after receiving shipment.

Return/Restocking Policy

Return shipments will not be accepted unless specifically authorized by Stylex in writing. The Return Authorization number should be clearly marked on the carton. The customer returning Stylex products is responsible for return shipping costs. Merchandise must be returned unused. Returned merchandise is subject to a 35% restocking fee.

Custom Products

Modifications to standard products will be considered for large runs. Contact factory for price quotations.

Design Changes

In keeping with modern manufacturing advances, Stylex reserves the right to incorporate minor modifications and design changes in products without notice.

Cancellation Policy

No charge prior to production except for inventory specifically requisitioned to fulfill the particular order. After production has begun, only actual costs incurred, including labor and material, will be billed to the customer.

WARRANTY

Except as provided below, Stylex warrants exclusively to the original Purchaser of our product that all parts, under normal use and service, will be free from defects in workmanship and material for a period of ten (10) years from the date of purchase. "Normal use and service" means that the product will be used in a typical office environment for 40-45 hours per week.

This warranty is subject to the following limitations, exclusions and provisions:

Limitations involving materials and components:

Wood components of plywood stacking chairs
(such as Brooks and Welcome)
5 years

Upholstery

(including mesh used for Click, F4, Insight, and Zephyr Mesh)
3 years

SAVA Mesh

10 years

COM Upholstery

No warranty
Stylex makes every effort to ensure that the COM Upholstery it approves is suitable for the intended use. Nevertheless, we will not warrant, and assume no responsibility for, the durability or tailoring quality of any COM or COL . If you have any concerns about the ultimate appearance of any covering, please order an upholstered sample.

Painted Stack Chair Frames

No Warranty

We will not warrant the finish of painted stack chair frames against damage from stacking. Please order chrome frames for chairs that will be stacked.

Felt Glides

No warranty

Due to the different surfaces on which felt glides may be used, we cannot warrant their durability over time.

If this product fails during normal use and service within the applicable warranty period (other than through normal wear and tear), please send a description of the relevant part and the nature of the defect, together with proof of purchase of the product, to Stylex at: Customer Service. c/o Stylex, P.O. Box 5038, Delanco, NJ 08075. PLEASE DO NOT RETURN PARTS OR THE PRODUCT TO STYLEX UNLESS INSTRUCTED TO DO SO BY STYLEX. Stylex will, at its option, either repair or replace the product or the part found defective by Stylex completely without charge for materials or labor. Purchaser may be required (at the option of Stylex) to return to Stylex at Purchaser's expense any defective part with all freight or shipping charges prepaid. The foregoing warranty shall be void if the product has been altered or repaired (other than by Stylex). The warranty does not cover damage to the product caused by accident, neglect, misuse, abuse, modification to the product by anyone other than Stylex or damage caused by use of the product for a purpose other than that for which it was designed. This warranty extends only to the original Purchaser of the product.

No Other Warranties

This warranty is in lieu of all other warranties, expressed or implied, including, but not limited to, implied warranties of merchantability and fitness for a particular purpose. The rights and remedies provided herein are the exclusive rights and remedies of the original purchaser of the product.

No Liability For Damages

In no event shall Stylex or its suppliers be responsible or liable for any special, indirect, consequential, or incidental damages. In no event shall the liability of Stylex exceed the actual purchase price paid to Stylex for the product.

Out of Warranty Products

For all products no longer covered by our warranty, please refer to our Design for Durability and Upgradability Policy. Contact Customer Service if you would like to purchase any replaceable components to further extend the life of any Stylex seating product. This warranty applies to all Stylex products purchased on April 13, 2018, and thereafter.

PRODUCT TAKE BACK PROGRAM

In order to be good stewards of our products, Stylex offers a pathway towards a Product Take Back Program as a more viable solution to the end of our products' originally intended life.

Stylex supports the sustainable programs of ANEW and offers their added value to our clients through a comprehensive take-back solution for surplus office furniture and materials of any kind, in any condition. ANEW is a 501(c)(3) non-profit organization that exists to provide companies with smart, cost effective alternatives for their surplus furniture and other items with the priority of matching it to non- profits, public agencies and the underserved, within the local community of the project site. Corporate Social Responsibility is raised while the impact on the environment is lowered by diverting products and materials otherwise destined for landfill.

Stylex is proud to offer ANEW to customers dedicated to strengthening their community network by repurposing their furniture, fixtures and architectural materials to those in need. In 2014, Stylex committed to making this relationship a part of our strategic sales strategy. Visit www.anewfound.org to find out more.

To initiate a Product Take Back strategy through ANEW, contact Stylex Customer Service at 800-257-5742.

For other end of life recovery options, please see our Product Disassembly Instructions and End of Life Recovery Options documents available on our website in the resources section of each product in our line.

FREIGHT PROGRAM

Stylex offers a Guaranteed Freight Program, which provides the purchaser the ability to determine shipping and handling charges at the time of order. Freight charges will be calculated as a percentage of the net product price and added to the invoice at the time of shipment. The continental United States has been divided into three zones. Please use the map below to determine the freight charges for the product's destination. There is a minimum freight charge of \$150.

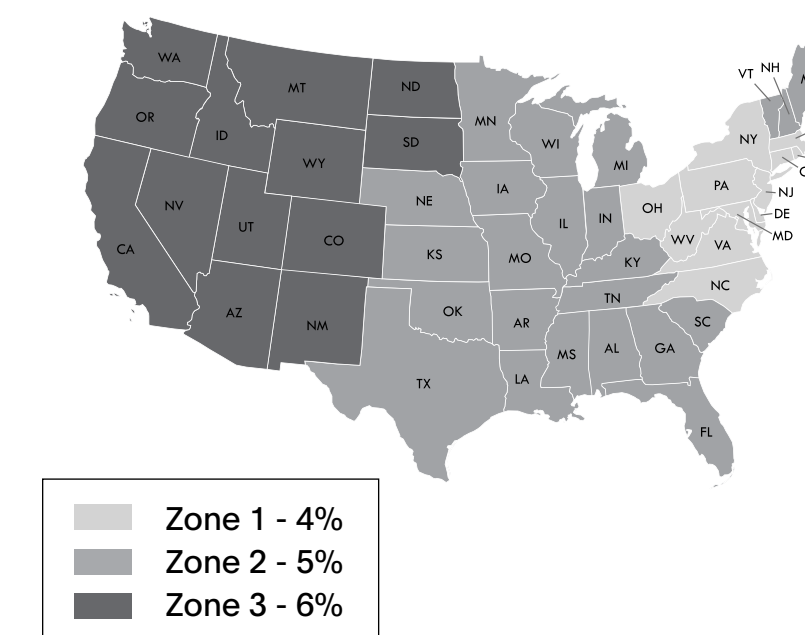

ZONE 1 - 4%

Connecticut
Delaware
New York
New Jersey
Maryland
Massachusetts
North Carolina
Ohio
Pennsylvania
Rhode Island
Virginia
Washington D.C.
West Virginia

ZONE 2 - 5%

Alabama
Arkansas
Canada, Ontario
Canada, Quebec
Florida
Georgia
Iowa
Illinois
Indiana
Kansas
Kentucky
Louisiana
Nebraska
New Hampshire
Oklahoma
Maine
Michigan
Minnesota
Missouri
Mississippi
South Carolina
Tennessee
Texas
Vermont
Wisconsin

ZONE 3 - 6%

Arizona
California
Colorado
Idaho
Montana
Nevada
New Mexico
North Dakota
Oregon
South Dakota
Utah
Washington
Wyoming

Quote Per Project
Alaska
Hawaii
Canada
(outside Ontario & Quebec)
Mexico

General Information

TEXTILE PARTNERS & APPROVALS

Textile Partners

To customize your furniture performance needs and design vision, Stylex offers a wide selection of in-graded leathers and textiles from Grades A through Y. We've partnered with leading manufacturers on the options, focusing on color, price, durability, and construction. To view our partners and explore our digital carded program with broadly approved textiles, visit [this page](#). We stand by these textiles: They're tried and tested, and will effortlessly fit into any design aesthetic.

Textile Approvals

To view Stylex Approved Textile documents to determine specific product approval status, visit [this page](#).

CAL 117 AND 133 COMPLIANCE

CAL 117-2013

All Stylex seating satisfies the requirements of CAL 117-2013 so long as one of our standard or in-graded fabrics is applied. COM textiles cannot be so guaranteed. Please contact the supplier of COM's directly to determine the fire retardancy of any COM supplied to us.

CAL 133

Most Stylex seating can be ordered to meet the requirements of CAL 133. When ordering, simply specify "CAL 133 compliance required". The upcharge for this option is \$54 list per yard. Please refer to the COM yardage of each model to determine the number of yards required. We do frequently require full-scale burn tests in order to certify CAL 133 before an order will be accepted. Such burn tests may increase normal lead times and do carry additional charges. Please contact customer service for details.

CUSTOMER'S OWN MATERIAL/LEATHER

Customer's own material (COM) and customer's own leather (COL) will generally be upholstered at the price designated in each product's price list. Please be advised, however, that we specifically reserve the right to charge a higher price when we determine that special circumstances, such as unusual repeats or challenging materials, present themselves. All orders for custom coverings must be approved by Stylex before they will be accepted for production. To submit proposed textile for approval, please use the COM form [here](#).

Special Note:

We assume no responsibility for the durability or tailoring quality of any COM or COL. Directional covers in particular may not meet your satisfaction due to the design of certain products. Please be advised that COM and COL orders are not subject to return. If you have doubts about the ultimate appearance of certain coverings, please order a sample done with that specific COM or COL. In addition, while we inspect fabrics for mill imperfections, some are difficult to recognize. We cannot be responsible for defects, color inaccuracies, dye lot variations, or other flaws.

Under no circumstances will we be responsible for COM shortages, flaws, or other such problems. Finally, it is not our responsibility to police the receipt of COM's in order to meet delivery deadlines, and we assume our customers are aware of any undue delay in the shipment of their COM fabrics.

COM fabric and COL leather should be sent prepaid to: Stylex

**Attn: COM/COL - [Your PO #]
740 Coopertown Road
Delanco, NJ 08075**

Clearly mark fabric or leather with the dealers name, purchase order number, and furniture model number of the item to be covered. Actual furniture orders should include the same information, as well as a description of the fabric or leather, including pattern and color number, in order to provide a cross reference.

Yardage requirements shown in the price list are based on non-directional goods of 54" width. Fabrics less than 54" wide or those requiring matching (stripes, prints, or large patterned designs) call for additional yardage. We will be happy to supply yardage requirements for large quantities where economies may be realized.

Add the following yardage for stripes, plaids, or patterns with repeats:

Fabric Width	Plain Fabric	2-14" Repeat	15-24" Repeat	25-27" Repeat	28-36" Repeat
54"	0%	10%	15%	20%	25%
50"	10%	20%	25%	30%	35%
48"	15%	25%	30%	35%	40%
45"	40%	50%	55%	60%	65%
36"	50%	60%	65%	70%	75%

COM/COL FORM

To avoid delay in processing COM orders we request that you submit a sample of your COM fabric stapled to this form which can be downloaded [here](#). If a fabric has a stripe or design, the size of the repeat should be indicated. Please indicate the fabric supplier's name, fabric number, and color. Also indicate the Stylex product on which the fabric will be used.

The fabric supplier must indicate on his shipping labels the dealer name and purchase order number as well as the Stylex model number.

Please Note:

No order may be entered into production or have a shipping date assigned until all related COM is received at the factory.



CENTER OF STRIPE OR DESIGN

TOP OF CHAIR	TOP OF CHAIR
--------------	--------------

1. Size of Repeat

2. Fabric Supplier

3. Fabric Number

4. Color

5. Stylex Product

Contents

<hr/>		<hr/>	
COLORS, MATERIALS, AND FINISHES	5	NON-STACKING CHAIR	12
<hr/>		<hr/>	
STATEMENT OF LINE	6	STACKING CHAIR	22
<hr/>		<hr/>	
DIMENSIONS	8	STOOL	25
<hr/>		<hr/>	
HOW TO ORDER	11		
<hr/>			

CLICK THE TITLES ABOVE TO NAVIGATE THROUGH THE DOCUMENT
PRODUCT HEADERS ON SUBSEQUENT PAGES LINK BACK TO THIS PAGE

Verve

COLORS, MATERIALS, AND FINISHES

POWDER COAT & METAL FINISH

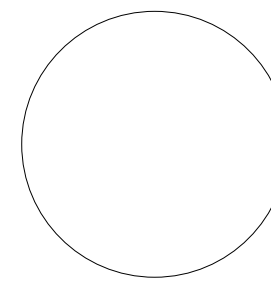

MILK
(MK)

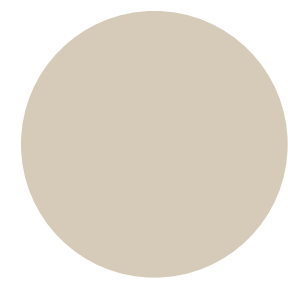

SAND
(SD)

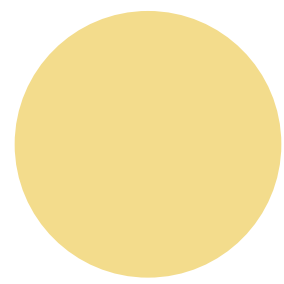

PALE YELLOW
(PY)

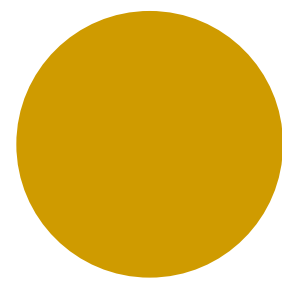

YELLOW
(YL)

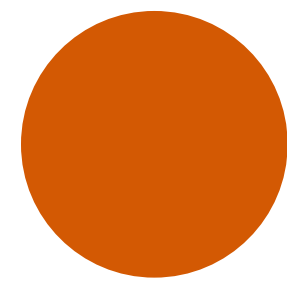

ORANGE
(OR)

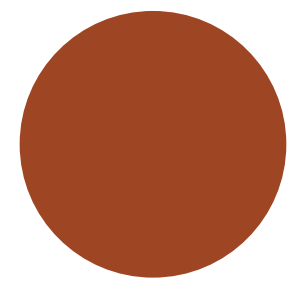

TERRACOTTA
(TC)

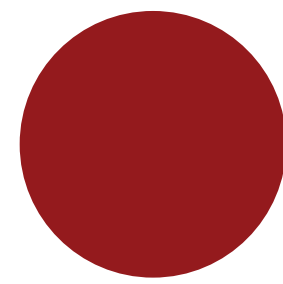

RED
(RD)

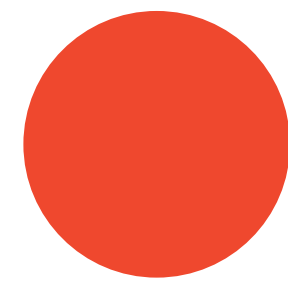

RED ORANGE
(RO)

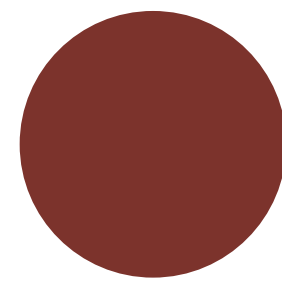

RUSTY RED
(RR)

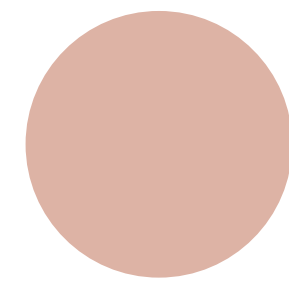

DUSTY PINK
(DP)

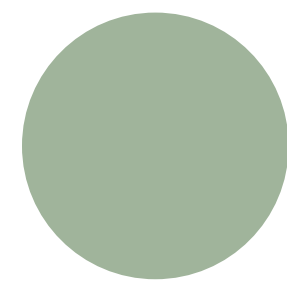

MEADOW GREEN
(MG)

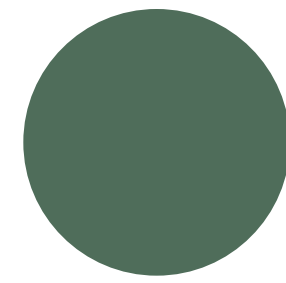

FOREST GREEN
(FG)

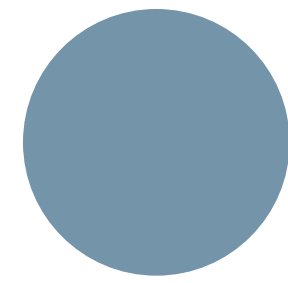

SOFT BLUE
(SB)

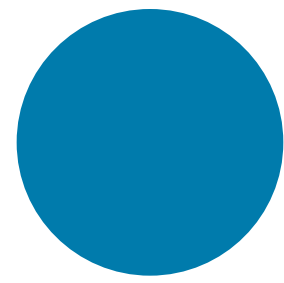

BLUE
(BL)

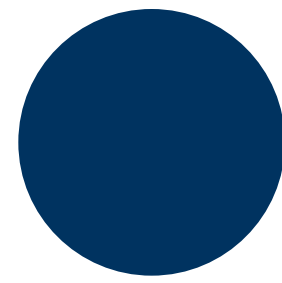

NAVY
(NV)

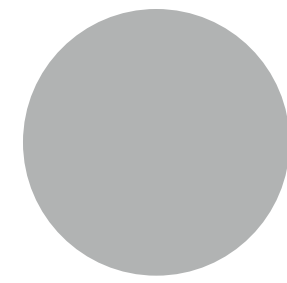

LIGHT GRAY
(LG)



CHAMPAGNE
(CP)

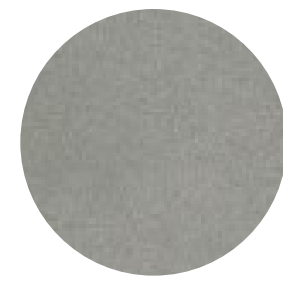

METALLIC SILVER
(MS)

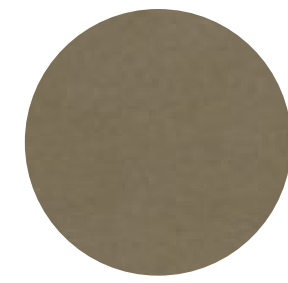

NICKEL
(NK)

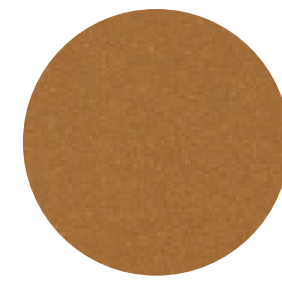

BRASS
(BR)

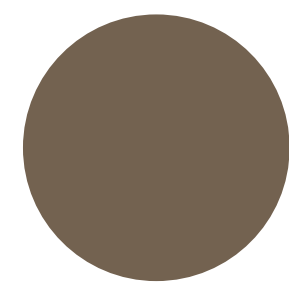

TAUPE
(TP)

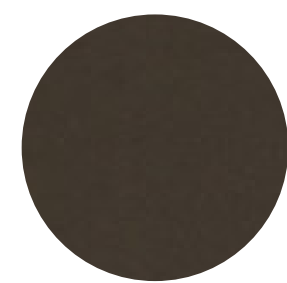

DARK BRONZE
(DB)

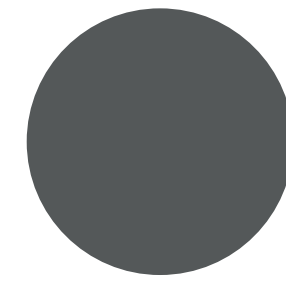

DARK GRAY
(DG)

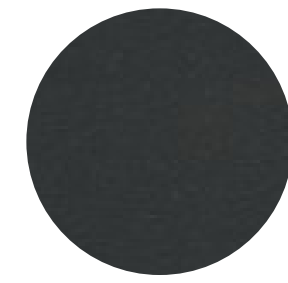

TEXTURED SLATE
(TS)

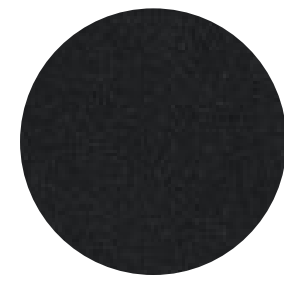

BLACK TWILIGHT
(BT)

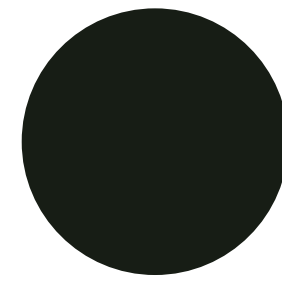

BLACK MATTE
(BM)

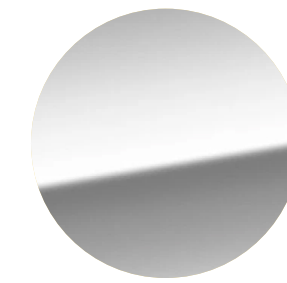

POLISHED ALUMINUM
(AL)

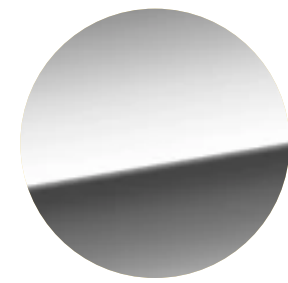

CHROME
(CH)

WOOD LEG



NATURAL MAPLE
(83)



WHITE OAK
(81)



WALNUT
(85)

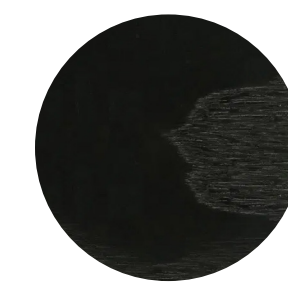

OPAQUE BLACK
(87)

PLASTIC SHELL

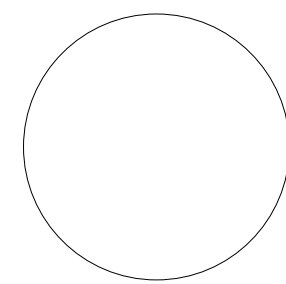

MILK
(02)

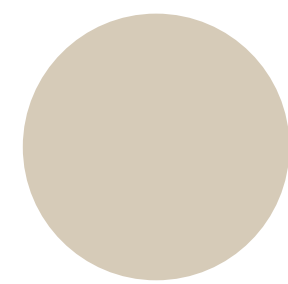

SAND
(19)

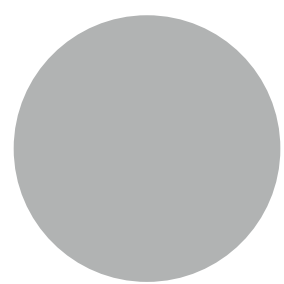

LIGHT GRAY
(03)

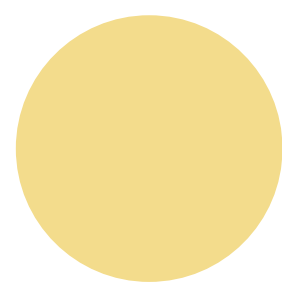

PALE YELLOW
(15)

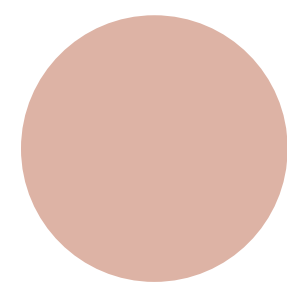

DUSTY PINK
(16)

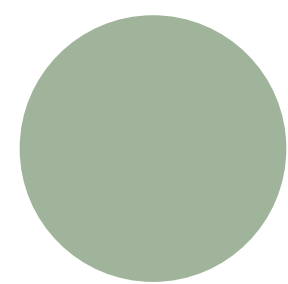

MEADOW GREEN
(17)

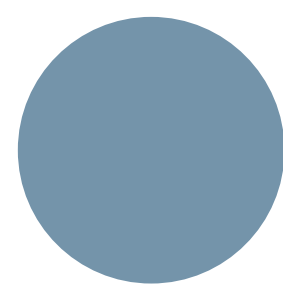

SOFT BLUE
(18)

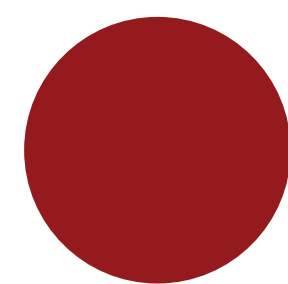

RED
(06)

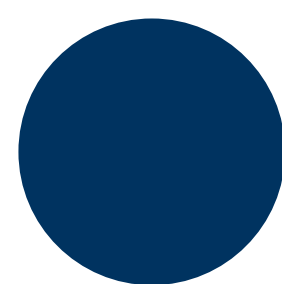

NAVY
(10)

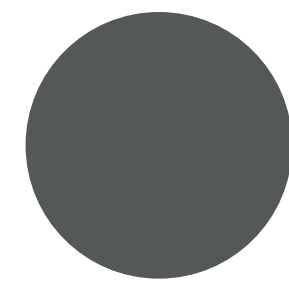

DARK GRAY
(12)

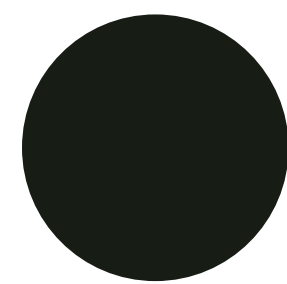

BLACK MATTE
(BM)

WOOD SHELL













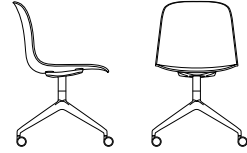

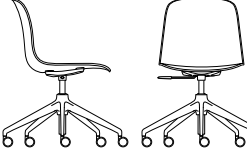







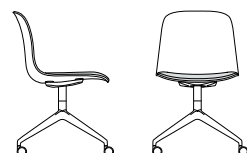

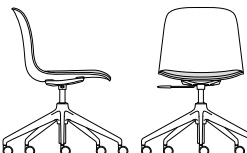









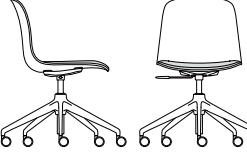







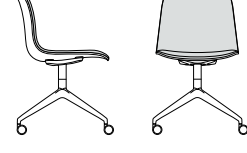

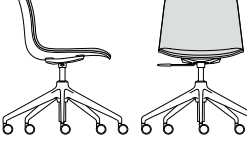



RIFT CUT OAK
(DZ02)

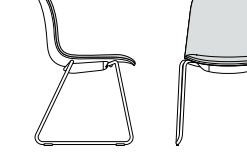

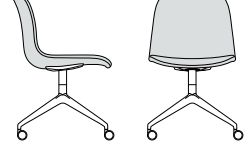
FLAT CUT WALNUT
(DZ01)

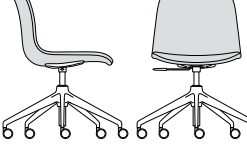
Verve

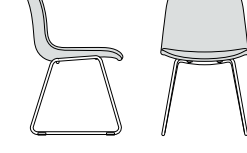
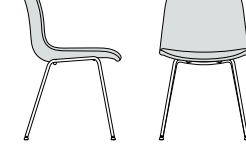
SPECIFICATION GUIDE: STATEMENT OF LINE, CHAIRS

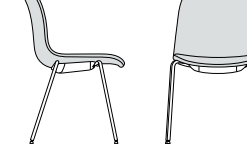
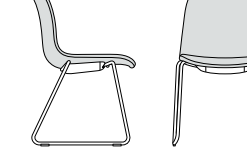
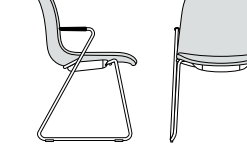
OVERVIEW	NON-STACKING								STACKING			
	FOUR BLADE	FOUR BLADE, ARM	FIVE BLADE	FIVE BLADE, ARM	SLED	FOUR LEG STEEL	FOUR LEG ALUMINUM	FOUR LEG WOOD	FOUR LEG STEEL	SLED	SLED, ARM	
Plastic/Wood Shell												
Plastic/Wood Shell Seat Pad												
Plastic/Wood Shell Loose Seat Pad												
Plastic Shell Upholstered Liner												
Fully Upholstered												

PRODUCT INFORMATION

Design

Mark Alan Kapka

Finishes

Plywood is a robust material which will continue to function for the life of the product despite scratches, dings, dents, etc. Stylex has made an effort to ensure a durable surface finish but does not warrant damage due to rough handling.

Most metal components are available in either powder coat or chrome. Tubular frames are powder coat or chrome. Wood legs are available in white oak, natural maple, walnut, or opaque black.

Casters

Casters are available in black, gray, and white. For 5-blade chairs, cylinders and lever handles are color matched to the caster color selected. When Polished Aluminum is the frame choice, the chair is shipped with a chrome cylinder regardless of caster color chosen.

Glides

Glides are either plastic or plastic with felt pads. Please note that felt pad glides are not available on models with aluminum legs.

Ganging

Available on armless, sled base stacking models.

Use

Designed for indoor use only.

Performance Standards

























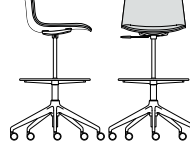
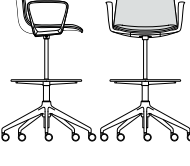
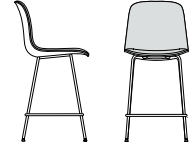

Manufactured to comply with:
ANSI/BIFMA X5.1 General-Purpose Office Chairs - Tests

Certifications

Greenguard Gold (does not apply to Verve Wood)
LEVEL® 1

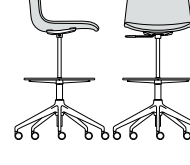
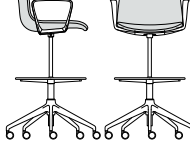
Verve

SPECIFICATION GUIDE: STATEMENT OF LINE, STOOLS, OPTIONS, ACCESSORIES

OVERVIEW	BAR			COUNTER		
	FOUR LEG STEEL	FIVE BLADE	FIVE BLADE, ARM	FOUR LEG STEEL	FIVE BLADE	FIVE BLADE, ARM
Plastic/Wood Shell						
Plastic/Wood Shell Seat Pad						
Plastic/Wood Shell Loose Seat Pad						
Plastic Shell Upholstered Liner						
Fully Upholstered						

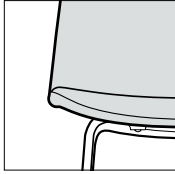
OPTIONS	STACKING ON FLOOR	STACKING ON DOLLY
Accessories Stacking Chair Transport Dolly 	Verve Wood w/ Uph: 5 high Verve Wood: 5 high Verve Plastic: 8 high	Verve Wood w/ Uph: 10 high Verve Wood: 14 high Verve Plastic: 14 high
Upholstery Contrasting Thread 		

PRODUCT INFORMATION

Design

Mark Alan Kapka

Finishes

Plywood is a robust material which will continue to function for the life of the product despite scratches, dings, dents, etc. Stylex has made an effort to ensure a durable surface finish but does not warrant damage due to rough handling.

Most metal components are available in either powder coat or chrome. Tubular frames are powder coat or chrome. Wood legs are available in white oak, natural maple, walnut, or opaque black.

Casters

Casters are available in black, gray, and white. For 5-blade chairs, cylinders and lever handles are color matched to the caster color selected. When Polished Aluminum is the frame choice, the chair is shipped with a chrome cylinder regardless of caster color chosen.

Glides

Glides are either plastic or plastic with felt pads. Please note that felt pad glides are not available on models with aluminum legs.

Ganging

Available on armless, sled base stacking models.

Use

Designed for indoor use only.

Performance Standards

Manufactured to comply with:
ANSI/BIFMA X5.1 General-Purpose Office Chairs - Tests

Certifications

Greenguard Gold (does not apply to Verve Wood)
LEVEL® 1

Verve

SPECIFICATION GUIDE: DIMENSIONS, NON-STACKING CHAIRS

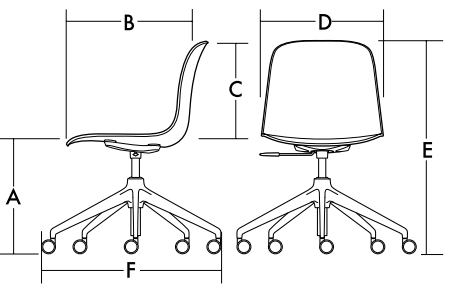
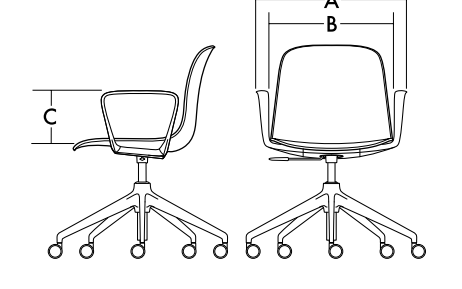
OVERVIEW	PLASTIC/WOOD SHELL						UPHOLSTERED					
<p>Dimensions</p> <p>A. Seat Height B. Seat Depth C. Back Height D. Seat Width & Overall Width E. Maximum Overall Height F. Maximum Overall Depth</p> 	<p>Four Blade</p> <p>A. 18 B. 18.7 C. 15 D. 18.7 E. 33 F. 29</p>	<p>Five Blade</p> <p>A. 15.6 - 20.9 B. 18.7 C. 15 D. 29 E. 30.6 - 35.9 F. 29</p>	<p>Sled</p> <p>A. 18.1 B. 18.7 C. 15 D. 18.7 E. 33.1 F. 21.8</p>	<p>Four Leg Steel</p> <p>A. 18.1 B. 18.7 C. 15 D. 18.7 E. 33.3 F. 21.8</p>	<p>Four Leg Alum.</p> <p>A. 18.1 B. 18.7 C. 15 D. 18.7 E. 33.1 F. 21.8</p>	<p>Four Leg Wood</p> <p>A. 17.8 B. 18.7 C. 15 D. 18.7 E. 32.8 F. 21.8</p>	<p>Four Blade</p> <p>A. 18.7 B. 19.2 C. 15 D. 19.6 E. 31.1 - 36.4 F. 29</p>	<p>Five Blade</p> <p>A. 16.3 - 21.5 B. 19.2 C. 15 D. 29 E. 31.1 - 36.4 F. 29</p>	<p>Sled</p> <p>A. 18.9 B. 19.2 C. 15 D. 19.6 E. 33.8 F. 22.7</p>	<p>Four Leg Steel</p> <p>A. 18.8 B. 19.2 C. 15 D. 19.6 E. 33.6 F. 22.7</p>	<p>Four Leg Alum.</p> <p>A. 18.8 B. 19.2 C. 15 D. 19.6 E. 33.6 F. 22.7</p>	<p>Four Leg Wood</p> <p>A. 18.5 B. 19.2 C. 15 D. 19.6 E. 33.3 F. 22.7</p>
<p>Arm Choice</p> <p>A. Max Width B. Arm Distance C. Arm Height</p> 	<p>Four Blade, Arm</p> <p>A. 23.2 B. 19 C. 7.3</p>	<p>Five Blade, Arm</p> <p>A. 23.2 B. 19 C. 7.3</p>					<p>Four Blade, Arm</p> <p>A. 23.2 B. 19 C. 7.3</p>	<p>Five Blade, Arm</p> <p>A. 23.2 B. 19 C. 7.3</p>				

Verve

SPECIFICATION GUIDE: DIMENSIONS, STACKING CHAIRS

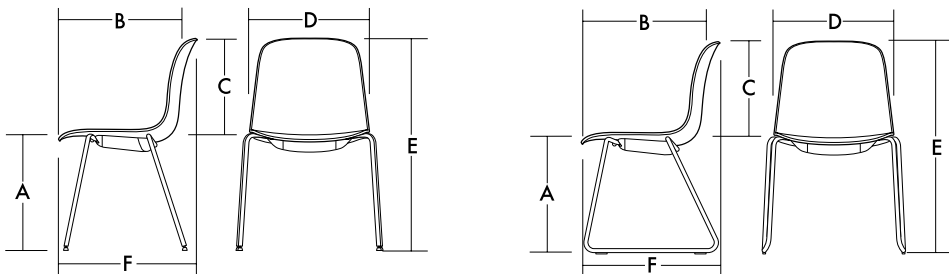
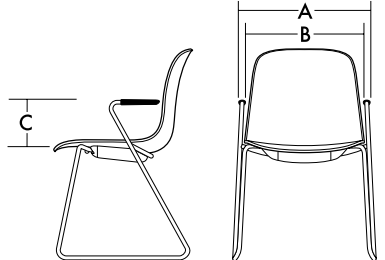
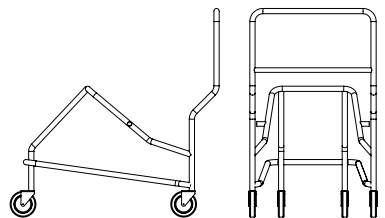
OVERVIEW	PLASTIC/WOOD SHELL	UPHOLSTERED
<p>Dimensions</p> <ul style="list-style-type: none"> A. Seat Height B. Seat Depth C. Back Height D. Seat Width & Overall Width E. Maximum Overall Height F. Maximum Overall Depth 	<p>Four Leg Steel</p> <ul style="list-style-type: none"> A. 18 B. 18.7 C. 15 D. 18.7 E. 33.1 F. 21.8 	<p>Sled</p> <ul style="list-style-type: none"> A. 18 B. 18.7 C. 15 D. 18.7 E. 31.1 F. 21.8 <p>Four Leg Steel</p> <ul style="list-style-type: none"> A. 18.7 B. 19.2 C. 15 D. 19.6 E. 33.6 F. 22.7 <p>Sled</p> <ul style="list-style-type: none"> A. 18.7 B. 19.2 C. 15 D. 19.6 E. 33.6 F. 22.7
<p>Arm Choice</p> <ul style="list-style-type: none"> A. Max Width B. Arm Distance C. Arm Height 		<p>Sled</p> <ul style="list-style-type: none"> A. 20.2 B. 18.2 C. 7.2 <p>Sled</p> <ul style="list-style-type: none"> A. 20.2 B. 18.2 C. 7.2
OVERVIEW	PLASTIC / UPHOLSTERED SHELL	WOOD SHELL
<p>Fully Stacked Dolly</p> <ul style="list-style-type: none"> A. Width B. Depth C. Height 	<p>14 Chair Maximum</p> <ul style="list-style-type: none"> A. 24.5 B. 44 C. 63 	<p>10 Chair Maximum</p> <ul style="list-style-type: none"> A. 24.5 B. 44 C. 51
<p>Stacked on Floor</p> <ul style="list-style-type: none"> A. Width B. Depth C. Height 	<p>8 Chair Maximum</p> <ul style="list-style-type: none"> A. 23.5 B. 33 C. 42 	<p>5 Chair Maximum</p> <ul style="list-style-type: none"> A. 23.5 B. 33 C. 39

Verve

SPECIFICATION GUIDE: DIMENSIONS, STOOLS

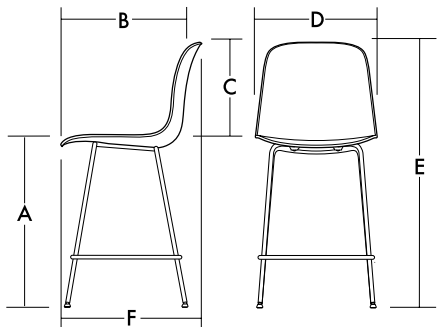
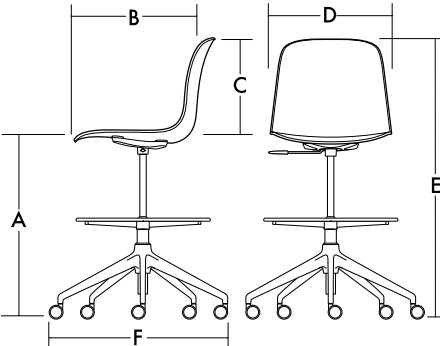
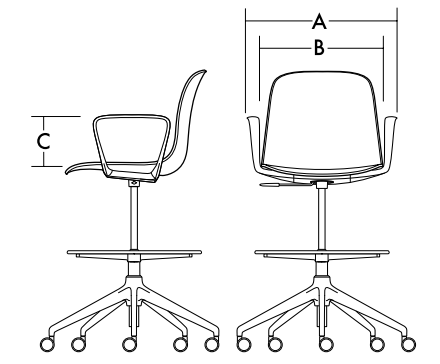
OVERVIEW	PLASTIC/WOOD SHELL		UPHOLSTERED	
<p>Dimensions</p> <ul style="list-style-type: none"> A. Seat Height B. Seat Depth C. Back Height D. Seat Width & Overall Width E. Maximum Overall Height F. Maximum Overall Depth 	<p>Four Leg Counter</p> <ul style="list-style-type: none"> A. 25.7 B. 18.7 C. 15 D. 18.7 E. 40.8 F. 21.8 	<p>Four Leg Bar</p> <ul style="list-style-type: none"> A. 30.6 B. 18.7 C. 15 D. 18.7 E. 45.7 F. 21.9 	<p>Four Leg Counter</p> <ul style="list-style-type: none"> A. 26.4 B. 19.2 C. 15 D. 19.6 E. 41.3 F. 22.7 	<p>Four Leg Bar</p> <ul style="list-style-type: none"> A. 31.3 B. 19.2 C. 15 D. 19.6 E. 46.2 F. 22.8
<p>Dimensions</p> <ul style="list-style-type: none"> A. Seat Height B. Seat Depth C. Back Height D. Seat Width & Overall Width E. Maximum Overall Height F. Maximum Overall Depth 	<p>Five Blade Counter</p> <ul style="list-style-type: none"> A. 21 - 28.7 B. 18.7 C. 15 D. 18.7 E. 36 - 43.7 F. 29 	<p>Five Blade Bar</p> <ul style="list-style-type: none"> A. 23.5 - 33.5 B. 18.7 C. 15 D. 29 E. 38.5 - 48.5 F. 21.8 	<p>Five Blade Counter</p> <ul style="list-style-type: none"> A. 21.7 - 29.4 B. 19.2 C. 15 D. 29 E. 36.5 - 44.2 F. 29 	<p>Five Blade Bar</p> <ul style="list-style-type: none"> A. 22.8 - 32.8 B. 19.2 C. 15 D. 29 E. 39.5 - 49 F. 29
<p>Arm Choice</p> <ul style="list-style-type: none"> A. Max Width B. Arm Distance C. Arm Height 	<p>Five Blade Counter</p> <ul style="list-style-type: none"> A. 23.2 B. 19 C. 7.3 	<p>Five Blade Bar</p> <ul style="list-style-type: none"> A. 23.2 B. 19 C. 7.3 	<p>Five Blade Counter</p> <ul style="list-style-type: none"> A. 23.2 B. 19 C. 7.3 	<p>Five Blade Bar</p> <ul style="list-style-type: none"> A. 23.2 B. 19 C. 7.3

Verve

SPECIFICATION GUIDE: HOW TO ORDER





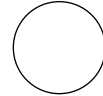
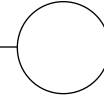
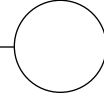
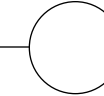
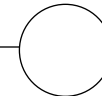
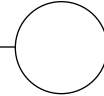
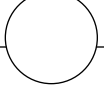
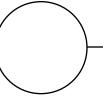

MODEL CODE BREAKDOWN

Sample Model Code: VR13120PG01BM81COM

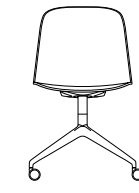
1. Series	2. Style	3. Arm Option	4. Upholstery Style	5. Casters/Glides	6. Shell Finish	7. Frame Finish	8. Textile
 <u>VR</u>	 <u>13</u>	 <u>1</u>	 <u>20</u>	 <u>PG</u>	 <u>01</u>	 <u>BM81</u>	 <u>COM</u>
Series VR - VERVE	Style 10 - STACKING CHAIR, FOUR LEG STEEL 11 - NON-STACKING CHAIR, FOUR LEG STEEL 12 - NON-STACKING CHAIR, 4 LEG ALUMINUM 13 - NON-STACKING CHAIR, FOUR LEG WOOD 30 - NON-STACKING CHAIR, FOUR BLADE SWIVEL 31 - NON-STACKING CHAIR, FOUR BLADE FIXED 35 - NON-STACKING CHAIR, FIVE BLADE 50 - STACKING CHAIR, SLED 51 - NON-STACKING CHAIR, SLED 70 - STOOL, FOUR LEG COUNTER 90 - STOOL, FOUR LEG COUNTER	Arm Option 1 - ARMLESS 2 - ARMS	Upholstery Style 10 - PLASTIC SHELL 20 - PLASTIC SHELL, SEAT PAD 25 - PLASTIC SHELL, LOOSE SEAT PAD 30 - PLASTIC SHELL, UPHOLSTERED LINER 40 - FULLY UPHOLSTERED 50 - WOOD SHELL 60 - WOOD SHELL, SEAT PAD 65 - WOOD SHELL, LOOSE SEAT PAD	Casters with Hard Wheels C1 - HARD, BLACK C2 - HARD, MILK WITH LIGHT GRAY TIRE C3 - HARD, LIGHT GRAY Casters with Soft Wheels CS1 - SOFT, BLACK CS2 - SOFT, MILK WITH LIGHT GRAY TIRE CS3 - SOFT, LIGHT GRAY Glides PG - PLASTIC GLIDES FG - PLASTIC GLIDES WITH FELT PADS	Plastic Finish 01 - BLACK MATTE 02 - MILK 03 - LIGHT GRAY 06 - RED 10 - NAVY 12 - DARK GRAY 15 - PALE YELLOW 16 - DUSTY PINK 17 - MEADOW GREEN 18 - SOFT BLUE 19 - SAND Wood Finish DZ01 - FLAT CUT WALNUT DZ02 - RIFT CUT OAK	Frame Color Standard Powder Coat BL - BLUE BM - BLACK MATTE BR - BRASS BT - BLACK TWILIGHT CP - CHAMPAGNE DB - DARK BRONZE DG - DARK GRAY DP - DUSTY PINK FG - FOREST GREEN LG - LIGHT GRAY MG - MEADOW GREEN MK - MILK MS - METALLIC SILVER NK - NICKEL NV - NAVY OR - ORANGE PY - PALE YELLOW RD - RED RO - RED ORANGE RR - RUSTY RED SB - SOFT BLUE SD - SAND TC - TERRACOTTA TP - TAUPE TS - TEXTURED SLATE YL - YELLOW Other AL - POLISHED ALUMINUM CH - CHROME Wood Leg Finish 81 - WHITE OAK 83 - NATURAL MAPLE 85 - WALNUT 87 - OPAQUE BLACK	Textile Textile Grades COM - CUSTOMER'S OWN MATERIAL A - GRADE A B - GRADE B C - GRADE C D - GRADE D E - GRADE E F - GRADE F G - GRADE G H - GRADE H I - GRADE I J - GRADE J K - GRADE K L - GRADE L M - GRADE M Leather Grades COL - CUSTOMER'S OWN LEATHER W - GRADE W X - GRADE X Y - GRADE Y E1 - GRADE E1 E2 - GRADE E2

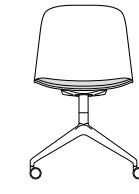
Verve

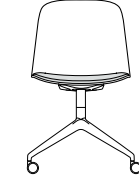
NON-STACKING CHAIR: FOUR BLADE SWIVEL

TITLE	SHELL/UPHOLSTERY	SERIES	FRAME	ARM	UPH	DIMENSIONS	COM	COL	Textile Upholstery Grades														Leather Upholstery Grades				
									YDG	SQFT	COM	A	B	C	D	E	F	G	H	I	J	K	L	M	W	X	Y
Non-Stacking Chair, Four Blade Swivel	 Plastic Shell	VR	30	1	10	18.7W x 29D x 33H	-	-	629	-	-	-	-	-	-	-	-	-	-	-	-	-	-	-	-	-	-
	 Wood Shell	VR	30	1	50	18.7W x 29D x 33H	-	-	1,394	-	-	-	-	-	-	-	-	-	-	-	-	-	-	-	-	-	
Non-Stacking Chair, Four Blade Swivel	 Plastic Shell, Seat Pad	VR	30	1	20	18.7W x 29D x 33H	0.4	7	802	832	848	865	881	898	918	933	955	983	1,016	1,050	1,082	1,114	969	999	1,157	1,192	1,322
	 Wood Shell, Seat Pad	VR	30	1	60	18.7W x 29D x 33H	0.4	7	1,568	1,598	1,614	1,631	1,647	1,664	1,684	1,699	1,721	1,749	1,782	1,816	1,848	1,880	1,735	1,765	1,923	1,958	2,088
Non-Stacking Chair, Four Blade Swivel	 Plastic Shell, Loose Seat Pad	VR	30	1	25	18.7W x 29D x 33H	0.4	7	842	872	889	904	922	937	956	973	995	1,023	1,056	1,089	1,121	1,154	1,008	1,038	1,196	1,231	1,362
	 Wood Shell, Loose Seat Pad	VR	30	1	65	18.7W x 29D x 33H	0.4	7	1,608	1,638	1,655	1,670	1,688	1,703	1,722	1,739	1,761	1,789	1,822	1,855	1,887	1,920	1,774	1,804	1,962	1,997	2,128
Non-Stacking Chair, Four Blade Swivel	 Plastic Shell, Upholstered Liner	VR	30	1	30	19.6W x 29D x 33.5H	0.8	11	936	997	1,028	1,060	1,095	1,127	1,162	1,199	1,241	1,296	1,362	1,427	1,493	1,559	1,209	1,264	1,523	1,581	1,796
Non-Stacking Chair, Four Blade Swivel	 Fully Upholstered	VR	30	1	40	19.6W x 29D x 33.5H	1.4	16	1,028	1,134	1,191	1,247	1,306	1,362	1,427	1,489	1,562	1,659	1,775	1,890	2,003	2,118	-	-	-	-	-

To Order Select Below

1. Series/Style/Arm

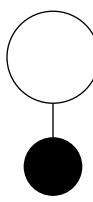

VR301

Verve Non-Stacking Chair, Four Blade Swivel

2. Upholstery

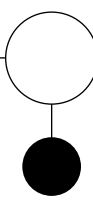

- 10 PLASTIC SHELL
- 20 PLASTIC SHELL, SEAT PAD
- 25 PLASTIC SHELL, LOOSE SEAT PAD
- 30 PLASTIC SHELL, UPHOLSTERED LINER
- 40 FULLY UPHOLSTERED
- 50 WOOD SHELL
- 60 WOOD SHELL, SEAT PAD
- 65 WOOD SHELL, LOOSE SEAT PAD

3. Caster or Glide

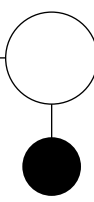

Caster

- C1 HARD, BLACK
- C2 HARD, MILK WITH LIGHT GRAY TIRE
- C3 HARD, LIGHT GRAY
- CS1 SOFT, BLACK **+42**
- CS2 SOFT, MILK WITH LIGHT GRAY TIRE **+42**
- CS3 SOFT, LIGHT GRAY **+42**

Glide

- PG PLASTIC GLIDES
- FG PLASTIC GLIDES WITH FELT PADS

4. Shell Finish

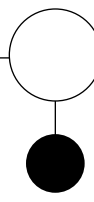

Plastic

- 01 BLACK MATTE
- 02 MILK
- 03 LIGHT GRAY
- 06 RED
- 10 NAVY
- 12 DARK GRAY
- 15 PALE YELLOW
- 16 DUSTY PINK
- 17 MEADOW GREEN
- 18 SOFT BLUE
- 19 SAND

Wood

- DZ01 FLAT CUT WALNUT
- DZ02 RIFT CUT OAK

5. Frame Finish

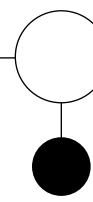

Powder Coat +53

- BL BLUE
- BM BLACK MATTE
- BR BRASS
- BT BLACK TWILIGHT
- CP CHAMPAGNE
- DB DARK BRONZE
- DG DARK GRAY
- DP DUSTY PINK
- FG FOREST GREEN
- LG LIGHT GRAY
- MG MEADOW GREEN
- MK MILK
- MS METALLIC SILVER
- NK NICKEL
- NV NAVY
- OR ORANGE
- PY PALE YELLOW
- RD RED
- RO RED ORANGE
- RR RUSTY RED
- SB SOFT BLUE
- SD SAND
- TC TERRACOTTA
- TP TAUPE
- TS TEXTURED SLATE
- YL YELLOW

Other

- AL POLISHED ALUMINUM

6. Options

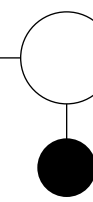

- CT CONTRASTING THREAD

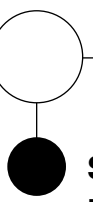

7. Upholstery



See general information section for details on textile program and COM/COL information.

Verve

NON-STACKING CHAIR: FOUR BLADE SWIVEL, ARM

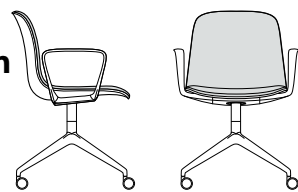
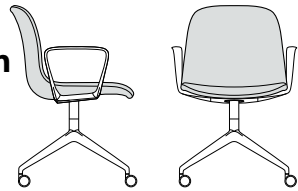
TITLE	SHELL/UPHOLSTERY	SERIES	FRAME	ARM	UPH	DIMENSIONS	COM	COL	Textile Upholstery Grades														Leather Upholstery Grades					
									YDG	SQFT	COM	A	B	C	D	E	F	G	H	I	J	K	L	M	W	X	Y	E1
Non-Stacking Chair, Four Blade Swivel, Arm 	Plastic Shell	VR	30	2	10	23.2W x 29D x 33H	-	-	795	-	-	-	-	-	-	-	-	-	-	-	-	-	-	-	-	-	-	-
	Wood Shell	VR	30	2	50	23.2W x 29D x 33H	-	-	1,560	-	-	-	-	-	-	-	-	-	-	-	-	-	-	-	-	-	-	
Non-Stacking Chair, Four Blade Swivel, Arm 	Plastic Shell, Seat Pad	VR	30	2	20	23.2W x 29D x 33H	0.4	7	968	998	1,014	1,031	1,047	1,064	1,084	1,099	1,121	1,149	1,182	1,216	1,248	1,280	1,135	1,165	1,323	1,358	1,488	
	Wood Shell, Seat Pad	VR	30	2	60	23.2W x 29D x 33H	0.4	7	1,734	1,764	1,780	1,797	1,813	1,830	1,850	1,865	1,887	1,915	1,948	1,982	2,014	2,046	1,901	1,931	2,089	2,124	2,254	
Non-Stacking Chair, Four Blade Swivel, Arm 	Plastic Shell, Loose Seat Pad	VR	30	2	25	23.2W x 29D x 33H	0.4	7	1,008	1,038	1,055	1,070	1,088	1,103	1,122	1,139	1,161	1,189	1,222	1,255	1,287	1,320	1,174	1,204	1,362	1,397	1,528	
	Wood Shell, Loose Seat Pad	VR	30	2	65	23.2W x 29D x 33H	0.4	7	1,774	1,804	1,821	1,836	1,854	1,869	1,888	1,905	1,927	1,955	1,988	2,021	2,053	2,086	1,940	1,970	2,128	2,163	2,294	
Non-Stacking Chair, Four Blade Swivel, Arm 	Plastic Shell, Upholstered Liner	VR	30	2	30	23.2W x 29D x 33.5H	0.8	11	1,102	1,163	1,194	1,226	1,261	1,293	1,328	1,365	1,407	1,462	1,528	1,593	1,659	1,725	1,375	1,430	1,689	1,747	1,962	
Non-Stacking Chair, Four Blade Swivel, Arm 	Fully Upholstered	VR	30	2	40	23.2W x 29D x 33.5H	1.4	16	1,194	1,300	1,357	1,413	1,472	1,528	1,593	1,655	1,728	1,825	1,941	2,056	2,169	2,284	-	-	-	-	-	

To Order Select Below

1. Series/Style/Arm

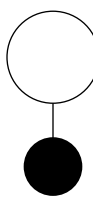

VR302

Verve Non-Stacking Chair, Four Blade Swivel, Arm

2. Upholstery

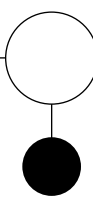

- 10 PLASTIC SHELL
- 20 PLASTIC SHELL, SEAT PAD
- 25 PLASTIC SHELL, LOOSE SEAT PAD
- 30 PLASTIC SHELL, UPHOLSTERED LINER
- 40 FULLY UPHOLSTERED
- 50 WOOD SHELL
- 60 WOOD SHELL, SEAT PAD
- 65 WOOD SHELL, LOOSE SEAT PAD

3. Caster or Glide

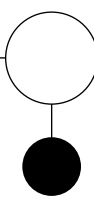

Caster

- C1 HARD, BLACK
- C2 HARD, MILK WITH LIGHT GRAY TIRE
- C3 HARD, LIGHT GRAY
- CS1 SOFT, BLACK **+42**
- CS2 SOFT, MILK WITH LIGHT GRAY TIRE **+42**
- CS3 SOFT, LIGHT GRAY **+42**

Glide

- PG PLASTIC GLIDES
- FG PLASTIC GLIDES WITH FELT PADS

4. Shell Finish

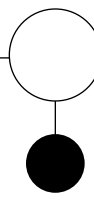

Plastic

- 01 BLACK MATTE
- 02 MILK
- 03 LIGHT GRAY
- 06 RED
- 10 NAVY
- 12 DARK GRAY
- 15 PALE YELLOW
- 16 DUSTY PINK
- 17 MEADOW GREEN
- 18 SOFT BLUE
- 19 SAND

Wood

- DZ01 FLAT CUT WALNUT
- DZ02 RIFT CUT OAK

5. Frame Finish

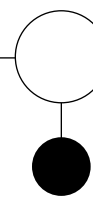

Powder Coat +65

- | | | |
|-------------------|--------------------|-------------------|
| BL BLUE | LG LIGHT GRAY | RO RED ORANGE |
| BM BLACK MATTE | MG MEADOW GREEN | RR RUSTY RED |
| BR BRASS | MK MILK | SB SOFT BLUE |
| BT BLACK TWILIGHT | MS METALLIC SILVER | SD SAND |
| CP CHAMPAGNE | NK NICKEL | TC TERRACOTTA |
| DB DARK BRONZE | NV NAVY | TP TAUPE |
| DG DARK GRAY | OR ORANGE | TS TEXTURED SLATE |
| DP DUSTY PINK | PY PALE YELLOW | YL YELLOW |
| FG FOREST GREEN | RD RED | |

Other

- AL POLISHED ALUMINUM

6. Options



- CT CONTRASTING THREAD



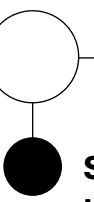



7. Upholstery

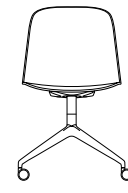

See general information section for details on textile program and COM/COL information.

Verve

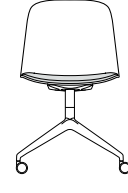
NON-STACKING CHAIR: FOUR BLADE FIXED

TITLE	SHELL/UPHOLSTERY	SERIES	FRAME	ARM	UPH	DIMENSIONS	YDG	SQFT	Textile Upholstery Grades													Leather Upholstery Grades						
									COM	COL	COM	A	B	C	D	E	F	G	H	I	J	K	L	M	W	X	Y	E1
Non-Stacking Chair, Four Blade Fixed	 Plastic Shell	VR	31	1	10	18.7W x 29D x 33H	-	-	564	-	-	-	-	-	-	-	-	-	-	-	-	-	-	-	-	-	-	-
	 Wood Shell	VR	31	1	50	18.7W x 29D x 33H	-	-	1,329	-	-	-	-	-	-	-	-	-	-	-	-	-	-	-	-	-	-	-
Non-Stacking Chair, Four Blade Fixed	 Plastic Shell, Seat Pad	VR	31	1	20	18.7W x 29D x 33H	0.4	7	737	767	783	800	816	833	853	868	890	918	951	985	1,017	1,049	904	934	1,092	1,127	1,257	
	 Wood Shell, Seat Pad	VR	31	1	60	18.7W x 29D x 33H	0.4	7	1,503	1,533	1,549	1,566	1,582	1,599	1,619	1,634	1,656	1,684	1,717	1,751	1,783	1,815	1,670	1,700	1,858	1,893	2,023	
Non-Stacking Chair, Four Blade Fixed	 Plastic Shell, Loose Seat Pad	VR	31	1	25	18.7W x 29D x 33H	0.4	7	777	807	824	839	857	872	891	908	930	958	991	1,024	1,056	1,089	943	973	1,131	1,166	1,297	
	 Wood Shell, Loose Seat Pad	VR	31	1	65	18.7W x 29D x 33H	0.4	7	1,543	1,573	1,590	1,605	1,623	1,638	1,657	1,674	1,696	1,724	1,757	1,790	1,822	1,855	1,709	1,739	1,897	1,932	2,063	
Non-Stacking Chair, Four Blade Fixed	 Plastic Shell, Upholstered Liner	VR	31	1	30	19.6W x 29D x 33.5H	0.8	11	871	932	963	995	1,030	1,062	1,097	1,134	1,176	1,231	1,297	1,362	1,428	1,494	1,144	1,199	1,458	1,516	1,731	
Non-Stacking Chair, Four Blade Fixed	 Fully Upholstered	VR	31	1	40	19.6W x 29D x 33.5H	1.4	16	963	1,069	1,126	1,182	1,241	1,297	1,362	1,424	1,497	1,594	1,710	1,825	1,938	2,053	-	-	-	-	-	

To Order Select Below

1. Series/Style/Arm

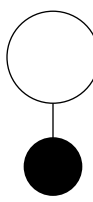

VR311

Verve Non-Stacking Chair, Four Blade Fixed

2. Upholstery

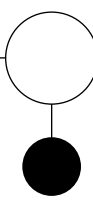

- 10 PLASTIC SHELL
- 20 PLASTIC SHELL, SEAT PAD
- 25 PLASTIC SHELL, LOOSE SEAT PAD
- 30 PLASTIC SHELL, UPHOLSTERED LINER
- 40 FULLY UPHOLSTERED
- 50 WOOD SHELL
- 60 WOOD SHELL, SEAT PAD
- 65 WOOD SHELL, LOOSE SEAT PAD

3. Caster or Glide

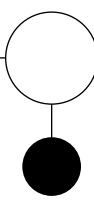

Caster

- C1 HARD, BLACK
- C2 HARD, MILK WITH LIGHT GRAY TIRE
- C3 HARD, LIGHT GRAY
- CS1 SOFT, BLACK **+42**
- CS2 SOFT, MILK WITH LIGHT GRAY TIRE **+42**
- CS3 SOFT, LIGHT GRAY **+42**

Glide

- PG PLASTIC GLIDES
- FG PLASTIC GLIDES WITH FELT PADS

4. Shell Finish

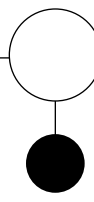

Plastic

- 01 BLACK MATTE
- 02 MILK
- 03 LIGHT GRAY
- 06 RED
- 10 NAVY
- 12 DARK GRAY
- 15 PALE YELLOW
- 16 DUSTY PINK
- 17 MEADOW GREEN
- 18 SOFT BLUE
- 19 SAND

Wood

- DZ01 FLAT CUT WALNUT
- DZ02 RIFT CUT OAK

5. Frame Finish

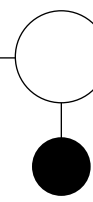

Powder Coat +53

- BL BLUE
- BM BLACK MATTE
- BR BRASS
- BT BLACK TWILIGHT
- CP CHAMPAGNE
- DB DARK BRONZE
- DG DARK GRAY
- DP DUSTY PINK
- FG FOREST GREEN
- LG LIGHT GRAY
- MG MEADOW GREEN
- MK MILK
- MS METALLIC SILVER
- NK NICKEL
- NV NAVY
- OR ORANGE
- PY PALE YELLOW
- RD RED
- RO RED ORANGE
- RR RUSTY RED
- SB SOFT BLUE
- SD SAND
- TC TERRACOTTA
- TP TAUPE
- TS TEXTURED SLATE
- YL YELLOW

Other

- AL POLISHED ALUMINUM

6. Options

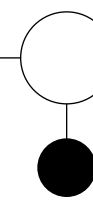

- CT CONTRASTING THREAD

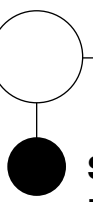

7. Upholstery



See general information section for details on textile program and COM/COL information.

Verve

NON-STACKING CHAIR: FOUR BLADE FIXED, ARM

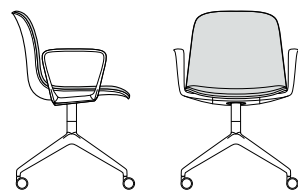
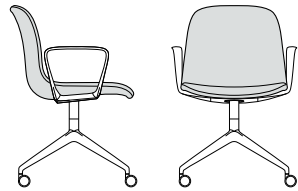
TITLE	SHELL/UPHOLSTERY	SERIES	FRAME	ARM	UPH	DIMENSIONS	COM	COL	Textile Upholstery Grades														Leather Upholstery Grades				
									YDG	SQFT	COM	A	B	C	D	E	F	G	H	I	J	K	L	M	W	X	Y
Non-Stacking Chair, Four Blade Fixed, Arm 	Plastic Shell	VR	31	2	10	23.2W x 29D x 33H	-	-	730	-	-	-	-	-	-	-	-	-	-	-	-	-	-	-	-	-	-
	Wood Shell	VR	31	2	50	23.2W x 29D x 33H	-	-	1,495	-	-	-	-	-	-	-	-	-	-	-	-	-	-	-	-	-	
Non-Stacking Chair, Four Blade Fixed, Arm 	Plastic Shell, Seat Pad	VR	31	2	20	23.2W x 29D x 33H	0.4	7	903	933	949	966	982	999	1,019	1,034	1,056	1,084	1,117	1,151	1,183	1,215	1,070	1,100	1,258	1,293	1,423
	Wood Shell, Seat Pad	VR	31	2	60	23.2W x 29D x 33H	0.4	7	1,669	1,699	1,715	1,732	1,748	1,765	1,785	1,800	1,822	1,850	1,883	1,917	1,949	1,981	1,836	1,866	2,024	2,059	2,189
Non-Stacking Chair, Four Blade Fixed, Arm 	Plastic Shell, Loose Seat Pad	VR	31	2	25	23.2W x 29D x 33H	0.4	7	943	973	990	1,005	1,023	1,038	1,057	1,074	1,096	1,124	1,157	1,190	1,222	1,255	1,109	1,139	1,297	1,332	1,463
	Wood Shell, Loose Seat Pad	VR	31	2	65	23.2W x 29D x 33H	0.4	7	1,709	1,739	1,756	1,771	1,789	1,804	1,823	1,840	1,862	1,890	1,923	1,956	1,988	2,021	1,875	1,905	2,063	2,098	2,229
Non-Stacking Chair, Four Blade Fixed, Arm 	Plastic Shell, Upholstered Liner	VR	31	2	30	23.2W x 29D x 33.5H	0.8	11	1,037	1,098	1,129	1,161	1,196	1,228	1,263	1,300	1,342	1,397	1,463	1,528	1,594	1,660	1,310	1,365	1,624	1,682	1,897
Non-Stacking Chair, Four Blade Fixed, Arm 	Fully Upholstered	VR	31	2	40	23.2W x 29D x 33.5H	1.4	16	1,129	1,235	1,292	1,348	1,407	1,463	1,528	1,590	1,663	1,760	1,876	1,991	2,104	2,219	-	-	-	-	-

To Order Select Below

1. Series/Style/Arm

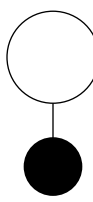

VR302

Verve Non-Stacking Chair, Four Blade Swivel, Arm

2. Upholstery

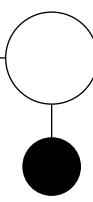

- 10 PLASTIC SHELL
- 20 PLASTIC SHELL, SEAT PAD
- 25 PLASTIC SHELL, LOOSE SEAT PAD
- 30 PLASTIC SHELL, UPHOLSTERED LINER
- 40 FULLY UPHOLSTERED
- 50 WOOD SHELL
- 60 WOOD SHELL, SEAT PAD
- 65 WOOD SHELL, LOOSE SEAT PAD

3. Caster or Glide

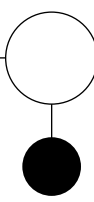

Caster

- C1 HARD, BLACK
- C2 HARD, MILK WITH LIGHT GRAY TIRE
- C3 HARD, LIGHT GRAY
- CS1 SOFT, BLACK **+42**
- CS2 SOFT, MILK WITH LIGHT GRAY TIRE **+42**
- CS3 SOFT, LIGHT GRAY **+42**

Glide

- PG PLASTIC GLIDES
- FG PLASTIC GLIDES WITH FELT PADS

4. Shell Finish

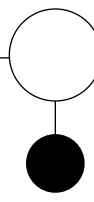

Plastic

- 01 BLACK MATTE
- 02 MILK
- 03 LIGHT GRAY
- 06 RED
- 10 NAVY
- 12 DARK GRAY
- 15 PALE YELLOW
- 16 DUSTY PINK
- 17 MEADOW GREEN
- 18 SOFT BLUE
- 19 SAND

Wood

- DZ01 FLAT CUT WALNUT
- DZ02 RIFT CUT OAK

5. Frame Finish

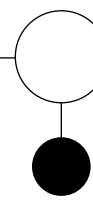

Powder Coat +65

- | | | |
|-------------------|--------------------|-------------------|
| BL BLUE | LG LIGHT GRAY | RO RED ORANGE |
| BM BLACK MATTE | MG MEADOW GREEN | RR RUSTY RED |
| BR BRASS | MK MILK | SB SOFT BLUE |
| BT BLACK TWILIGHT | MS METALLIC SILVER | SD SAND |
| CP CHAMPAGNE | NK NICKEL | TC TERRACOTTA |
| DB DARK BRONZE | NV NAVY | TP TAUPE |
| DG DARK GRAY | OR ORANGE | TS TEXTURED SLATE |
| DP DUSTY PINK | PY PALE YELLOW | YL YELLOW |
| FG FOREST GREEN | RD RED | |

Other

- AL POLISHED ALUMINUM

6. Options

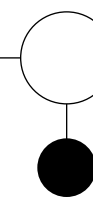

- CT CONTRASTING THREAD

7. Upholstery

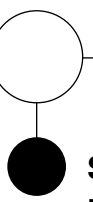

See general information section for details on textile program and COM/COL information.

Verve

NON-STACKING CHAIR: FIVE BLADE

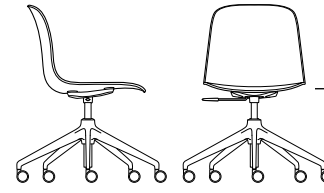
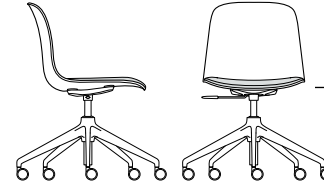
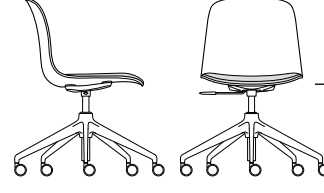
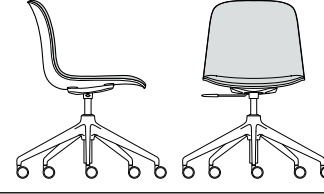
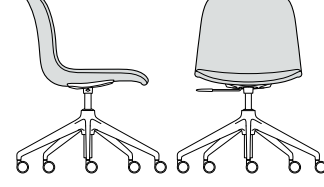
TITLE	SHELL/UPHOLSTERY	SERIES	FRAME	ARM	UPH	DIMENSIONS	YDG	SQFT	Textile Upholstery Grades													Leather Upholstery Grades					
									COM	COL	COM	A	B	C	D	E	F	G	H	I	J	K	L	M	W	X	Y
Non-Stacking Chair, Five Blade 	Plastic Shell	VR	35	1	10	29W x 29D x 30.6 - 35.9H	-	-	630	-	-	-	-	-	-	-	-	-	-	-	-	-	-	-	-	-	-
	Wood Shell	VR	35	1	50	29W x 29D x 30.6 - 35.9H	-	-	1,395	-	-	-	-	-	-	-	-	-	-	-	-	-	-	-	-	-	
Non-Stacking Chair, Five Blade 	Plastic Shell, Seat Pad	VR	35	1	20	29W x 29D x 30.6 - 35.9H	0.4	7	803	833	849	866	882	899	919	934	956	984	1,017	1,051	1,083	1,115	970	1,000	1,158	1,193	1,323
	Wood Shell, Seat Pad	VR	35	1	60	29W x 29D x 30.6 - 35.9H	0.4	7	1,569	1,599	1,615	1,632	1,648	1,665	1,685	1,700	1,722	1,750	1,783	1,817	1,849	1,881	1,736	1,766	1,924	1,959	2,089
Non-Stacking Chair, Five Blade 	Plastic Shell, Loose Seat Pad	VR	35	1	25	29W x 29D x 30.6 - 35.9H	0.4	7	843	873	890	905	923	938	957	974	996	1,024	1,057	1,090	1,122	1,155	1,009	1,039	1,197	1,232	1,363
	Wood Shell, Loose Seat Pad	VR	35	1	65	29W x 29D x 30.6 - 35.9H	0.4	7	1,609	1,639	1,656	1,671	1,689	1,704	1,723	1,740	1,762	1,790	1,823	1,856	1,888	1,921	1,775	1,805	1,963	1,998	2,129
Non-Stacking Chair, Five Blade 	Plastic Shell, Upholstered Liner	VR	35	1	30	29W x 29D x 31.1 - 36.4H	0.8	11	937	998	1,029	1,061	1,096	1,128	1,163	1,200	1,242	1,297	1,363	1,428	1,494	1,560	1,210	1,265	1,524	1,582	1,797
Non-Stacking Chair, Five Blade 	Fully Upholstered	VR	35	1	40	29W x 29D x 31.1 - 36.4H	1.4	16	1,029	1,135	1,192	1,248	1,307	1,363	1,428	1,490	1,563	1,660	1,776	1,891	2,004	2,119	-	-	-	-	-

To Order Select Below

1. Series/Style/Arm

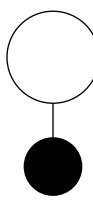

VR351

Verve Non-Stacking Chair, Five Blade

2. Upholstery

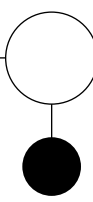

- 10 PLASTIC SHELL
- 20 PLASTIC SHELL, SEAT PAD
- 25 PLASTIC SHELL, LOOSE SEAT PAD
- 30 PLASTIC SHELL, UPHOLSTERED LINER
- 40 FULLY UPHOLSTERED
- 50 WOOD SHELL
- 60 WOOD SHELL, SEAT PAD
- 65 WOOD SHELL, LOOSE SEAT PAD

3. Caster or Glide

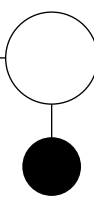

Caster

- C1 HARD, BLACK
- C2 HARD, MILK WITH LIGHT GRAY TIRE
- C3 HARD, LIGHT GRAY
- CS1 SOFT, BLACK **+42**
- CS2 SOFT, MILK WITH LIGHT GRAY TIRE **+42**
- CS3 SOFT, LIGHT GRAY **+42**

Glide

- PG PLASTIC GLIDES
- FG PLASTIC GLIDES WITH FELT PADS

4. Shell Finish

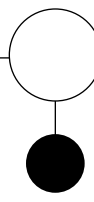

Plastic

- 01 BLACK MATTE
- 02 MILK
- 03 LIGHT GRAY
- 06 RED
- 10 NAVY
- 12 DARK GRAY
- 15 PALE YELLOW
- 16 DUSTY PINK
- 17 MEADOW GREEN
- 18 SOFT BLUE
- 19 SAND

Wood

- DZ01 FLAT CUT WALNUT
- DZ02 RIFT CUT OAK

5. Frame Finish

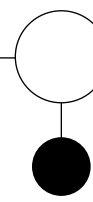

Powder Coat +53

- | | | |
|-------------------|--------------------|-------------------|
| BL BLUE | LG LIGHT GRAY | RO RED ORANGE |
| BM BLACK MATTE | MG MEADOW GREEN | RR RUSTY RED |
| BR BRASS | MK MILK | SB SOFT BLUE |
| BT BLACK TWILIGHT | MS METALLIC SILVER | SD SAND |
| CP CHAMPAGNE | NK NICKEL | TC TERRACOTTA |
| DB DARK BRONZE | NV NAVY | TP TAUPE |
| DG DARK GRAY | OR ORANGE | TS TEXTURED SLATE |
| DP DUSTY PINK | PY PALE YELLOW | YL YELLOW |
| FG FOREST GREEN | RD RED | |

Other

- AL POLISHED ALUMINUM

6. Options

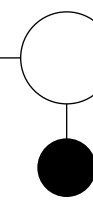

- CT CONTRASTING THREAD

7. Upholstery

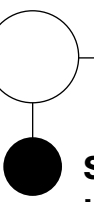





See general information section for details on textile program and COM/COL information.

Cylinder and lever handles match caster color selected. On chairs with glides, cylinders and lever handles are black, unless Milk or Light Gray is the selected frame color. Exception: Polished Aluminum frames will ship with chrome cylinders.

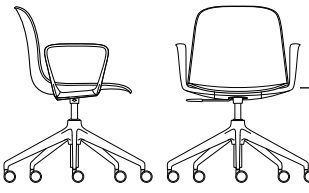
Verve

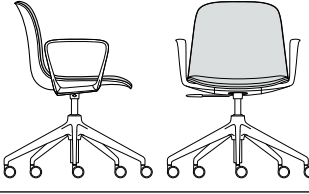
NON-STACKING CHAIR: FIVE BLADE, ARM

TITLE	SHELL/UPHOLSTERY	SERIES	FRAME	ARM	UPH	DIMENSIONS	YDG	SQFT	Textile Upholstery Grades														Leather Upholstery Grades				
									COM	COL	COM	A	B	C	D	E	F	G	H	I	J	K	L	M	W	X	Y
Non-Stacking Chair, Five Blade, Arm 	Plastic Shell	VR	35	2	10	29W x 29D x 30.6 - 35.9H	-	-	796	-	-	-	-	-	-	-	-	-	-	-	-	-	-	-	-	-	-
	Wood Shell	VR	35	2	50	29W x 29D x 30.6 - 35.9H	-	-	1,561	-	-	-	-	-	-	-	-	-	-	-	-	-	-	-	-	-	
Non-Stacking Chair, Five Blade, Arm 	Plastic Shell, Seat Pad	VR	35	2	20	29W x 29D x 30.6 - 35.9H	0.4	7	969	999	1,015	1,032	1,048	1,065	1,085	1,100	1,122	1,150	1,183	1,217	1,249	1,281	1,136	1,166	1,324	1,359	1,489
	Wood Shell, Seat Pad	VR	35	2	60	29W x 29D x 30.6 - 35.9H	0.4	7	1,735	1,765	1,781	1,798	1,814	1,831	1,851	1,866	1,888	1,916	1,949	1,983	2,015	2,047	1,902	1,932	2,090	2,125	2,255
Non-Stacking Chair, Five Blade, Arm 	Plastic Shell, Loose Seat Pad	VR	35	2	25	29W x 29D x 30.6 - 35.9H	0.4	7	1,009	1,039	1,056	1,071	1,089	1,104	1,123	1,140	1,162	1,190	1,223	1,256	1,288	1,321	1,175	1,205	1,363	1,398	1,529
	Wood Shell, Loose Seat Pad	VR	35	2	65	29W x 29D x 30.6 - 35.9H	0.4	7	1,775	1,805	1,822	1,837	1,855	1,870	1,889	1,906	1,928	1,956	1,989	2,022	2,054	2,087	1,941	1,971	2,129	2,164	2,295
Non-Stacking Chair, Five Blade, Arm 	Plastic Shell, Upholstered Liner	VR	35	2	30	29W x 29D x 31.1 - 36.4H	0.8	11	1,103	1,164	1,195	1,227	1,262	1,294	1,329	1,366	1,408	1,463	1,529	1,594	1,660	1,726	1,376	1,431	1,690	1,748	1,963
Non-Stacking Chair, Five Blade, Arm 	Fully Upholstered	VR	35	2	40	29W x 29D x 31.1 - 36.4H	1.4	16	1,195	1,301	1,358	1,414	1,473	1,529	1,594	1,656	1,729	1,826	1,942	2,057	2,170	2,285	-	-	-	-	-

To Order Select Below

1. Series/Style/Arm

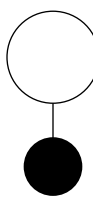

VR352

Verve Non-Stacking Chair, Five Blade, Arm

2. Upholstery

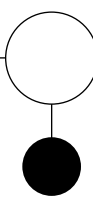

- 10 PLASTIC SHELL
- 20 PLASTIC SHELL, SEAT PAD
- 25 PLASTIC SHELL, LOOSE SEAT PAD
- 30 PLASTIC SHELL, UPHOLSTERED LINER
- 40 FULLY UPHOLSTERED
- 50 WOOD SHELL
- 60 WOOD SHELL, SEAT PAD
- 65 WOOD SHELL, LOOSE SEAT PAD

3. Caster or Glide

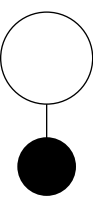

- Caster**
- C1 HARD, BLACK
- C2 HARD, MILK WITH LIGHT GRAY TIRE
- C3 HARD, LIGHT GRAY
- CS1 SOFT, BLACK **+42**
- CS2 SOFT, MILK WITH LIGHT GRAY TIRE **+42**
- CS3 SOFT, LIGHT GRAY **+42**
- Glide**
- PG PLASTIC GLIDES
- FG PLASTIC GLIDES WITH FELT PADS

4. Shell Finish

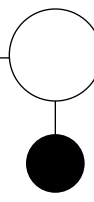

- Plastic**
- 01 BLACK MATTE
- 02 MILK
- 03 LIGHT GRAY
- 06 RED
- 10 NAVY
- 12 DARK GRAY
- 15 PALE YELLOW
- 16 DUSTY PINK
- 17 MEADOW GREEN
- 18 SOFT BLUE
- 19 SAND
- Wood**
- DZ01 FLAT CUT WALNUT
- DZ02 RIFT CUT OAK

5. Frame Finish

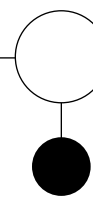

- Powder Coat +65**
- BL BLUE
- BM BLACK MATTE
- BR BRASS
- BT BLACK TWILIGHT
- CP CHAMPAGNE
- DB DARK BRONZE
- DG DARK GRAY
- DP DUSTY PINK
- FG FOREST GREEN
- LG LIGHT GRAY
- MG MEADOW GREEN
- MK MILK
- MS METALLIC SILVER
- NK NICKEL
- NV NAVY
- OR ORANGE
- PY PALE YELLOW
- RD RED
- RO RED ORANGE
- RR RUSTY RED
- SB SOFT BLUE
- SD SAND
- TC TERRACOTTA
- TP TAUPE
- TS TEXTURED SLATE
- YL YELLOW
- Other**
- AL POLISHED ALUMINUM

6. Options

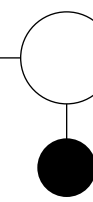

- CT CONTRASTING THREAD

7. Upholstery

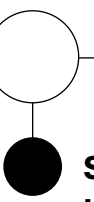









See general information section for details on textile program and COM/COL information.

Cylinder and lever handles match caster color selected. On chairs with glides, cylinders and lever handles are black, unless Milk or Light Gray is the selected frame color. Exception: Polished Aluminum frames will ship with chrome cylinders.

Verve

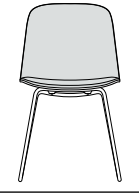
NON-STACKING CHAIR: SLED

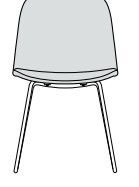
TITLE	SHELL/UPHOLSTERY	SERIES	FRAME	ARM	UPH	DIMENSIONS	YDG	SQFT	Textile Upholstery Grades													Leather Upholstery Grades					
									COM	COL	COM	A	B	C	D	E	F	G	H	I	J	K	L	M	W	X	Y
Non-Stacking Chair, Sled  	Plastic Shell	VR	51	1	10	18.7W x 21.8D x 33.3H	-	-	504	-	-	-	-	-	-	-	-	-	-	-	-	-	-	-	-	-	-
	Wood Shell	VR	51	1	50	18.7W x 21.8D x 33.3H	-	-	1,269	-	-	-	-	-	-	-	-	-	-	-	-	-	-	-	-	-	
Non-Stacking Chair, Sled  	Plastic Shell, Seat Pad	VR	51	1	20	18.7W x 21.8D x 33.3H	0.4	7	677	707	723	740	756	773	793	808	830	858	891	925	957	989	844	874	1,032	1,067	1,197
	Wood Shell, Seat Pad	VR	51	1	60	18.7W x 21.8D x 33.3H	0.4	7	1,443	1,473	1,489	1,506	1,522	1,539	1,559	1,574	1,596	1,624	1,657	1,691	1,723	1,755	1,610	1,640	1,798	1,833	1,963
Non-Stacking Chair, Sled  	Plastic Shell, Loose Seat Pad	VR	51	1	25	18.7W x 21.8D x 33.3H	0.4	7	717	747	764	779	797	812	831	848	870	898	931	964	996	1,029	883	913	1,071	1,106	1,237
	Wood Shell, Loose Seat Pad	VR	51	1	65	18.7W x 21.8D x 33.3H	0.4	7	1,483	1,513	1,530	1,545	1,563	1,578	1,597	1,614	1,636	1,664	1,697	1,730	1,762	1,795	1,649	1,679	1,837	1,872	2,003
Non-Stacking Chair, Sled  	Plastic Shell, Upholstered Liner	VR	51	1	30	19.6W x 22.7D x 33.8H	0.8	11	811	872	903	935	970	1,002	1,037	1,074	1,116	1,171	1,237	1,302	1,368	1,434	1,084	1,139	1,398	1,456	1,671
Non-Stacking Chair, Sled  	Fully Upholstered	VR	51	1	40	19.6W x 22.7D x 33.8H	1.4	16	903	1,009	1,066	1,122	1,181	1,237	1,302	1,364	1,437	1,534	1,650	1,765	1,878	1,993	-	-	-	-	-

To Order Select Below

1. Series/Style/Arm

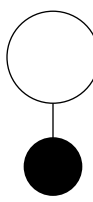

VR511

Verve Non-Stacking Chair, Sled

2. Upholstery

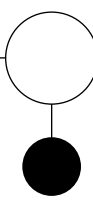

- 10 PLASTIC SHELL
- 20 PLASTIC SHELL, SEAT PAD
- 25 PLASTIC SHELL, LOOSE SEAT PAD
- 30 PLASTIC SHELL, UPHOLSTERED LINER
- 40 FULLY UPHOLSTERED
- 50 WOOD SHELL
- 60 WOOD SHELL, SEAT PAD
- 65 WOOD SHELL, LOOSE SEAT PAD

3. Glide

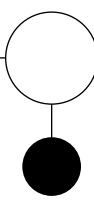

- PG PLASTIC GLIDES
- FG PLASTIC GLIDES WITH FELT PADS

4. Shell Finish

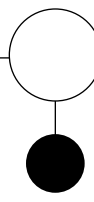

- Plastic**
- 01 BLACK MATTE
- 02 MILK
- 03 LIGHT GRAY
- 06 RED
- 10 NAVY
- 12 DARK GRAY
- 15 PALE YELLOW
- 16 DUSTY PINK
- 17 MEADOW GREEN
- 18 SOFT BLUE
- 19 SAND
- Wood**
- DZ01 FLAT CUT WALNUT
- DZ02 RIFT CUT OAK

5. Frame Finish

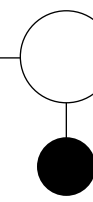

- Powder Coat**
- BL BLUE
- BM BLACK MATTE
- BR BRASS
- BT BLACK TWILIGHT
- CP CHAMPAGNE
- DB DARK BRONZE
- DG DARK GRAY
- DP DUSTY PINK
- FG FOREST GREEN
- LG LIGHT GRAY
- MG MEADOW GREEN
- MK MILK
- MS METALLIC SILVER
- NK NICKEL
- NV NAVY
- OR ORANGE
- PY PALE YELLOW
- RD RED
- RO RED ORANGE
- RR RUSTY RED
- SB SOFT BLUE
- SD SAND
- TC TERRACOTTA
- TP TAUPE
- TS TEXTURED SLATE
- YL YELLOW
- Other**
- CH CHROME

6. Options

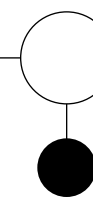

- CT CONTRASTING THREAD



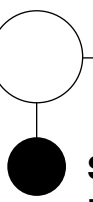





7. Upholstery



See general information section for details on textile program and COM/COL information.

Verve

NON-STACKING CHAIR: FOUR LEG STEEL

TITLE	SHELL/UPHOLSTERY	SERIES	FRAME	ARM	UPH	DIMENSIONS	YDG	SQFT	Textile Upholstery Grades														Leather Upholstery Grades				
									COM	COL	COM	A	B	C	D	E	F	G	H	I	J	K	L	M	W	X	Y
Non-Stacking Chair, Four Leg Steel	 Plastic Shell	VR	11	1	10	18.7W x 21.8D x 33.1H	-	-	504	-	-	-	-	-	-	-	-	-	-	-	-	-	-	-	-	-	-
	 Wood Shell	VR	11	1	50	18.7W x 21.8D x 33.1H	-	-	1,269	-	-	-	-	-	-	-	-	-	-	-	-	-	-	-	-	-	-
Non-Stacking Chair, Four Leg Steel	 Plastic Shell, Seat Pad	VR	11	1	20	18.7W x 21.8D x 33.1H	0.4	7	677	707	723	740	756	773	793	808	830	858	891	925	957	989	844	874	1,032	1,067	1,197
	 Wood Shell, Seat Pad	VR	11	1	60	18.7W x 21.8D x 33.1H	0.4	7	1,443	1,473	1,489	1,506	1,522	1,539	1,559	1,574	1,596	1,624	1,657	1,691	1,723	1,755	1,610	1,640	1,798	1,833	1,963
Non-Stacking Chair, Four Leg Steel	 Plastic Shell, Loose Seat Pad	VR	11	1	25	18.7W x 21.8D x 33.1H	0.4	7	717	747	764	779	797	812	831	848	870	898	931	964	996	1,029	883	913	1,071	1,106	1,237
	 Wood Shell, Loose Seat Pad	VR	11	1	65	18.7W x 21.8D x 33.1H	0.4	7	1,483	1,513	1,530	1,545	1,563	1,578	1,597	1,614	1,636	1,664	1,697	1,730	1,762	1,795	1,649	1,679	1,837	1,872	2,003
Non-Stacking Chair, Four Leg Steel	 Plastic Shell, Upholstered Liner	VR	11	1	30	19.6W x 22.7D x 33.6H	0.8	11	811	872	903	935	970	1,002	1,037	1,074	1,116	1,171	1,237	1,302	1,368	1,434	1,084	1,139	1,398	1,456	1,671
Non-Stacking Chair, Four Leg Steel	 Fully Upholstered	VR	11	1	40	19.6W x 22.7D x 33.6H	1.4	16	903	1,009	1,066	1,122	1,181	1,237	1,302	1,364	1,437	1,534	1,650	1,765	1,878	1,993	-	-	-	-	-

To Order Select Below

1. Series/Style/Arm

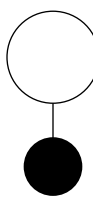

VR111

Verve Non-Stacking Chair, Four Leg Steel

2. Upholstery

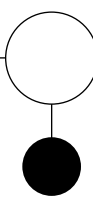

- 10 PLASTIC SHELL
- 20 PLASTIC SHELL, SEAT PAD
- 25 PLASTIC SHELL, LOOSE SEAT PAD
- 30 PLASTIC SHELL, UPHOLSTERED LINER
- 40 FULLY UPHOLSTERED
- 50 WOOD SHELL
- 60 WOOD SHELL, SEAT PAD
- 65 WOOD SHELL, LOOSE SEAT PAD

3. Glide

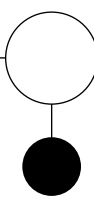

- Glide**
- PG PLASTIC GLIDES
- FG PLASTIC GLIDES WITH FELT PADS

4. Shell Finish

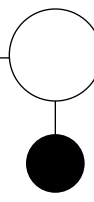

- Plastic**
 - 01 BLACK MATTE
 - 02 MILK
 - 03 LIGHT GRAY
 - 06 RED
 - 10 NAVY
 - 12 DARK GRAY
 - 15 PALE YELLOW
 - 16 DUSTY PINK
 - 17 MEADOW GREEN
 - 18 SOFT BLUE
 - 19 SAND
- Wood**
 - DZ01 FLAT CUT WALNUT
 - DZ02 RIFT CUT OAK

5. Frame Finish

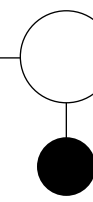

- Powder Coat**
 - BL BLUE
 - BM BLACK MATTE
 - BR BRASS
 - BT BLACK TWILIGHT
 - CP CHAMPAGNE
 - DB DARK BRONZE
 - DG DARK GRAY
 - DP DUSTY PINK
 - FG FOREST GREEN
 - LG LIGHT GRAY
 - MG MEADOW GREEN
 - MK MILK
 - MS METALLIC SILVER
 - NK NICKEL
 - NV NAVY
 - OR ORANGE
 - PY PALE YELLOW
 - RD RED
 - RO RED ORANGE
 - RR RUSTY RED
 - SB SOFT BLUE
 - SD SAND
 - TC TERRACOTTA
 - TP TAUPE
 - TS TEXTURED SLATE
 - YL YELLOW
- Other**
 - CH CHROME

6. Options

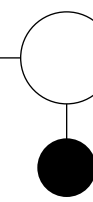

- CT CONTRASTING THREAD



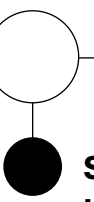





7. Upholstery



See general information section for details on textile program and COM/COL information.

Verve

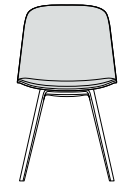
NON-STACKING CHAIR: FOUR LEG ALUMINUM

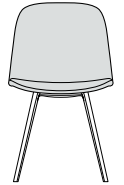
TITLE	SHELL/UPHOLSTERY	SERIES	FRAME	ARM	UPH	DIMENSIONS	YDG	SQFT	Textile Upholstery Grades													Leather Upholstery Grades						
									COM	COL	COM	A	B	C	D	E	F	G	H	I	J	K	L	M	W	X	Y	E1
Non-Stacking Chair, Four Leg Aluminum  	Plastic Shell	VR	12	1	10	18.7W x 21.8D x 33.1H	-	-	624	-	-	-	-	-	-	-	-	-	-	-	-	-	-	-	-	-	-	-
	Wood Shell	VR	12	1	50	18.7W x 21.8D x 33.1H	-	-	1,389	-	-	-	-	-	-	-	-	-	-	-	-	-	-	-	-	-	-	-
Non-Stacking Chair, Four Leg Aluminum  	Plastic Shell, Seat Pad	VR	12	1	20	18.7W x 21.8D x 33.1H	0.4	7	797	827	843	860	876	893	913	928	950	978	1,011	1,045	1,077	1,109	964	994	1,152	1,187	1,317	
	Wood Shell, Seat Pad	VR	12	1	60	18.7W x 21.8D x 33.1H	0.4	7	1,563	1,593	1,609	1,626	1,642	1,659	1,679	1,694	1,716	1,744	1,777	1,811	1,843	1,875	1,730	1,760	1,918	1,953	2,083	
Non-Stacking Chair, Four Leg Aluminum  	Plastic Shell, Loose Seat Pad	VR	12	1	25	18.7W x 21.8D x 33.1H	0.4	7	837	867	884	899	917	932	951	968	990	1,018	1,051	1,084	1,116	1,149	1,003	1,033	1,191	1,226	1,357	
	Wood Shell, Loose Seat Pad	VR	12	1	65	18.7W x 21.8D x 33.1H	0.4	7	1,603	1,633	1,650	1,665	1,683	1,698	1,717	1,734	1,756	1,784	1,817	1,850	1,882	1,915	1,769	1,799	1,957	1,992	2,123	
Non-Stacking Chair, Four Leg Aluminum  	Plastic Shell, Upholstered Liner	VR	12	1	30	19.6W x 22.7D x 33.6H	0.8	11	931	992	1,023	1,055	1,090	1,122	1,157	1,194	1,236	1,291	1,357	1,422	1,488	1,554	1,204	1,259	1,518	1,576	1,791	
Non-Stacking Chair, Four Leg Aluminum  	Fully Upholstered	VR	12	1	40	19.6W x 22.7D x 33.6H	1.4	16	1,023	1,129	1,186	1,242	1,301	1,357	1,422	1,484	1,557	1,654	1,770	1,885	1,998	2,113	-	-	-	-	-	

To Order Select Below

1. Series/Style/Arm

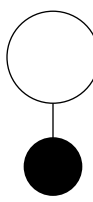

VR121

Verve Non-Stacking Chair, Four Leg Aluminum

2. Upholstery

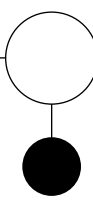

- 10 PLASTIC SHELL
- 20 PLASTIC SHELL, SEAT PAD
- 25 PLASTIC SHELL, LOOSE SEAT PAD
- 30 PLASTIC SHELL, UPHOLSTERED LINER
- 40 FULLY UPHOLSTERED
- 50 WOOD SHELL
- 60 WOOD SHELL, SEAT PAD
- 65 WOOD SHELL, LOOSE SEAT PAD

3. Glide

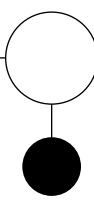

- PG GLIDE
- PG PLASTIC GLIDES

4. Shell Finish

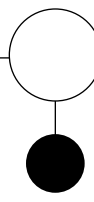

- 01 BLACK MATTE
- 02 MILK
- 03 LIGHT GRAY
- 06 RED
- 10 NAVY
- 12 DARK GRAY
- 15 PALE YELLOW
- 16 DUSTY PINK
- 17 MEADOW GREEN
- 18 SOFT BLUE
- 19 SAND

- DZ01 FLAT CUT WALNUT
- DZ02 RIFT CUT OAK

5. Frame Finish

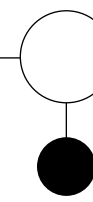

- BL BLUE
- BM BLACK MATTE
- BR BRASS
- BT BLACK TWILIGHT
- CP CHAMPAGNE
- DB DARK BRONZE
- DG DARK GRAY
- DP DUSTY PINK
- FG FOREST GREEN
- LG LIGHT GRAY
- MG MEADOW GREEN
- MK MILK
- MS METALLIC SILVER
- NK NICKEL
- NV NAVY
- OR ORANGE
- PY PALE YELLOW
- RD RED
- RO RED ORANGE
- RR RUSTY RED
- SB SOFT BLUE
- SD SAND
- TC TERRACOTTA
- TP TAUPE
- TS TEXTURED SLATE
- YL YELLOW

Other

- AL POLISHED ALUMINUM

6. Options

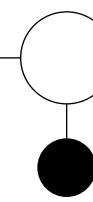

- CT CONTRASTING THREAD

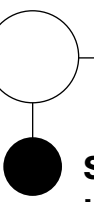

7. Upholstery



See general information section for details on textile program and COM/COL information.

Verve

NON-STACKING CHAIR: FOUR LEG WOOD

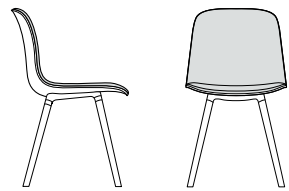
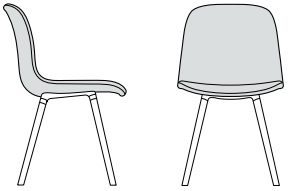





TITLE	SHELL/UPHOLSTERY	SERIES	FRAME	ARM	UPH	DIMENSIONS	YDG	SQFT	Textile Upholstery Grades														Leather Upholstery Grades					
									COM	COL	COM	A	B	C	D	E	F	G	H	I	J	K	L	M	W	X	Y	E1
Non-Stacking Chair, Four Leg Wood 	Plastic Shell	VR	13	1	10	18.7W x 21.8D x 32.8H	-	-	821	-	-	-	-	-	-	-	-	-	-	-	-	-	-	-	-	-	-	-
	Wood Shell	VR	13	1	50	18.7W x 21.8D x 32.8H	-	-	1,586	-	-	-	-	-	-	-	-	-	-	-	-	-	-	-	-	-	-	
Non-Stacking Chair, Four Leg Wood 	Plastic Shell, Seat Pad	VR	13	1	20	18.7W x 21.8D x 32.8H	0.4	7	994	1,024	1,040	1,057	1,073	1,090	1,110	1,125	1,147	1,175	1,208	1,242	1,274	1,306	1,161	1,191	1,349	1,384	1,514	
	Wood Shell, Seat Pad	VR	13	1	60	18.7W x 21.8D x 32.8H	0.4	7	1,760	1,790	1,806	1,823	1,839	1,856	1,876	1,891	1,913	1,941	1,974	2,008	2,040	2,072	1,927	1,957	2,115	2,150	2,280	
Non-Stacking Chair, Four Leg Wood 	Plastic Shell, Loose Seat Pad	VR	13	1	25	18.7W x 21.8D x 32.8H	0.4	7	1,034	1,064	1,081	1,096	1,114	1,129	1,148	1,165	1,187	1,215	1,248	1,281	1,313	1,346	1,200	1,230	1,388	1,423	1,554	
	Wood Shell, Loose Seat Pad	VR	13	1	65	18.7W x 21.8D x 32.8H	0.4	7	1,800	1,830	1,847	1,862	1,880	1,895	1,914	1,931	1,953	1,981	2,014	2,047	2,079	2,112	1,966	1,996	2,154	2,189	2,320	
Non-Stacking Chair, Four Leg Wood 	Plastic Shell, Upholstered Liner	VR	13	1	30	19.6W x 22.7D x 33.3H	0.8	11	1,128	1,189	1,220	1,252	1,287	1,319	1,354	1,391	1,433	1,488	1,554	1,619	1,685	1,751	1,401	1,456	1,715	1,773	1,988	
Non-Stacking Chair, Four Leg Wood 	Fully Upholstered	VR	13	1	40	19.6W x 22.7D x 33.3H	1.4	16	1,220	1,326	1,383	1,439	1,498	1,554	1,619	1,681	1,754	1,851	1,967	2,082	2,195	2,310	-	-	-	-	-	

To Order Select Below

<p>1. Series/Style/Arm</p> <p>VR131</p> <p>Verve Non-Stacking Chair, Four Leg Wood</p>	<p>2. Upholstery</p> <p>10 PLASTIC SHELL</p> <p>20 PLASTIC SHELL, SEAT PAD</p> <p>25 PLASTIC SHELL, LOOSE SEAT PAD</p> <p>30 PLASTIC SHELL, UPHOLSTERED LINER</p> <p>40 FULLY UPHOLSTERED</p> <p>50 WOOD SHELL</p> <p>60 WOOD SHELL, SEAT PAD</p> <p>65 WOOD SHELL, LOOSE SEAT PAD</p>	<p>3. Glide</p> <p>PG PLASTIC GLIDES</p> <p>FG PLASTIC GLIDES WITH FELT PADS</p>	<p>4. Shell Finish</p> <p>01 BLACK MATTE</p> <p>02 MILK</p> <p>03 LIGHT GRAY</p> <p>06 RED</p> <p>10 NAVY</p> <p>12 DARK GRAY</p> <p>15 PALE YELLOW</p> <p>16 DUSTY PINK</p> <p>17 MEADOW GREEN</p> <p>18 SOFT BLUE</p> <p>19 SAND</p>	<p>5. Frame Finish</p> <p>DZ01 FLAT CUT WALNUT</p> <p>DZ02 RIFT CUT OAK</p> <p>BL BLUE</p> <p>BM BLACK MATTE</p> <p>BR BRASS</p> <p>BT BLACK TWILIGHT</p> <p>CP CHAMPAGNE</p> <p>DB DARK BRONZE</p> <p>DG DARK GRAY</p> <p>DP DUSTY PINK</p> <p>FG FOREST GREEN</p> <p>AL POLISHED ALUMINUM</p> <p>LG LIGHT GRAY</p> <p>MG MEADOW GREEN</p> <p>MK MILK</p> <p>MS METALLIC SILVER</p> <p>NK NICKEL</p> <p>NV NAVY</p> <p>OR ORANGE</p> <p>PY PALE YELLOW</p> <p>RD RED</p>	<p>6. Wood Finishes</p> <p>81 WHITE OAK</p> <p>83 NATURAL MAPLE</p> <p>85 WALNUT +68</p> <p>87 OPAQUE BLACK +68</p>	<p>7 & 8. Options & Upholstery</p> <p>CT CONTRASTING THREAD</p> <p>general information section or details on textile program and COM/COL information.</p>
--	---	---	---	--	--	---

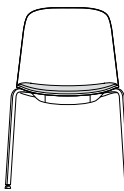
Verve

STACKING CHAIR: FOUR LEG STEEL

TITLE	SHELL/UPHOLSTERY	SERIES	FRAME	ARM	UPH	DIMENSIONS	YDG	SQFT	Textile Upholstery Grades													Leather Upholstery Grades					
									COM	COL	COM	A	B	C	D	E	F	G	H	I	J	K	L	M	W	X	Y
Stacking Chair, Four Leg Steel	 Plastic Shell	VR	10	1	10	18.7W x 21.8D x 33.1H	-	-	462	-	-	-	-	-	-	-	-	-	-	-	-	-	-	-	-	-	-
	 Wood Shell	VR	10	1	50	18.7W x 21.8D x 33.1H	-	-	1,227	-	-	-	-	-	-	-	-	-	-	-	-	-	-	-	-	-	
Stacking Chair, Four Leg Steel	 Plastic Shell, Seat Pad	VR	10	1	20	18.7W x 21.8D x 33.1H	0.4	7	635	665	681	698	714	731	751	766	788	816	849	883	915	947	802	832	990	1,025	1,155
	 Wood Shell, Seat Pad	VR	10	1	60	18.7W x 21.8D x 33.1H	0.4	7	1,401	1,431	1,447	1,464	1,480	1,497	1,517	1,532	1,554	1,582	1,615	1,649	1,681	1,713	1,568	1,598	1,756	1,791	1,921
Stacking Chair, Four Leg Steel	 Plastic Shell, Loose Seat Pad	VR	10	1	25	18.7W x 21.8D x 33.1H	0.4	7	675	705	722	737	755	770	789	806	828	856	889	922	954	987	841	871	1,029	1,064	1,195
	 Wood Shell, Loose Seat Pad	VR	10	1	65	18.7W x 21.8D x 33.1H	0.4	7	1,441	1,471	1,488	1,503	1,521	1,536	1,555	1,572	1,594	1,622	1,655	1,688	1,720	1,753	1,607	1,637	1,795	1,830	1,961
Stacking Chair, Four Leg Steel	 Plastic Shell, Upholstered Liner	VR	10	1	30	19.6W x 22.7D x 33.6H	0.8	11	769	830	861	893	928	960	995	1,032	1,074	1,129	1,195	1,260	1,326	1,392	1,042	1,097	1,356	1,414	1,629
Stacking Chair, Four Leg Steel	 Fully Upholstered	VR	10	1	40	19.6W x 22.7D x 33.6H	1.4	16	861	967	1,024	1,080	1,139	1,195	1,260	1,322	1,395	1,492	1,608	1,723	1,836	1,951	-	-	-	-	-

To Order Select Below

1. Series/Style/Arm

VR101

Verve Stacking Chair, Four Leg Steel

Stacking on Floor:
8 high - Verve Plastic
5 high - Verve Wood
5 high - Verve Wood w/ Uph.

Stacking on Dolly:
14 high - Verve Plastic
14 high - Verve Wood
10 high - Verve Wood w/ Uph.

2. Upholstery

10	PLASTIC SHELL
20	PLASTIC SHELL, SEAT PAD
25	PLASTIC SHELL, LOOSE SEAT PAD
30	PLASTIC SHELL, UPHOLSTERED LINER
40	FULLY UPHOLSTERED
50	WOOD SHELL
60	WOOD SHELL, SEAT PAD
65	WOOD SHELL, LOOSE SEAT PAD

3. Glide

PG	PLASTIC GLIDES
FG	PLASTIC GLIDES WITH FELT PADS

4. Shell Finish

01	BLACK MATTE
02	MILK
03	LIGHT GRAY
06	RED
10	NAVY
12	DARK GRAY
15	PALE YELLOW
16	DUSTY PINK
17	MEADOW GREEN
18	SOFT BLUE
19	SAND

5. Frame Finish

BL	BLUE	LG	LIGHT GRAY	RO	RED ORANGE
BM	BLACK MATTE	MG	MEADOW GREEN	RR	RUSTY RED
BR	BRASS	MK	MILK	SB	SOFT BLUE
BT	BLACK TWILIGHT	MS	METALLIC SILVER	SD	SAND
CP	CHAMPAGNE	NK	NICKEL	TC	TERRACOTTA
DB	DARK BRONZE	NV	NAVY	TP	TAUPE
DG	DARK GRAY	OR	ORANGE	TS	TEXTURED SLATE
DP	DUSTY PINK	PY	PALE YELLOW	YL	YELLOW
FG	FOREST GREEN	RD	RED		
CH	CHROME				

Other

Stylex will not warrant painted frames against damage caused by stacking. Only use dollies with chrome frames. We will not warrant powder coated Verve frames used on dollies against damage to the finish.

6. Options

CT	CONTRASTING THREAD
VRTD2	VERVE TRANSPORT DOLLY FOR FOUR LEG FRAME PLASTIC OR WOOD SHELL +1,208
VRTD4	VERVE TRANSPORT DOLLY FOR FOUR LEG FRAME PLASTIC OR WOOD SHELL WITH UPHOLSTERY +1,208







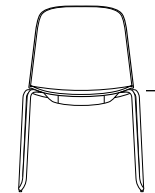

Accessories

7. Upholstery

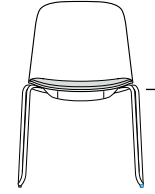
See general information section for details on textile program and COM/COL information.

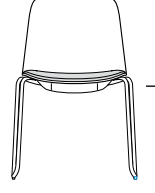
Verve

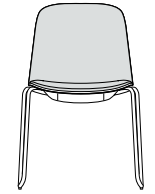
STACKING CHAIR: SLED

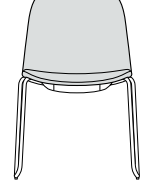
TITLE	SHELL/UPHOLSTERY	SERIES	FRAME	ARM	UPH	DIMENSIONS	YDG	COL	Textile Upholstery Grades													Leather Upholstery Grades						
									COM	COL	COM	A	B	C	D	E	F	G	H	I	J	K	L	M	W	X	Y	E1
Stacking Chair, Sled  	Plastic Shell	VR	50	1	10	18.7W x 21.8D x 33.1H	-	-	449	-	-	-	-	-	-	-	-	-	-	-	-	-	-	-	-	-	-	-
	Wood Shell	VR	50	1	50	18.7W x 21.8D x 33.1H	-	-	1,214	-	-	-	-	-	-	-	-	-	-	-	-	-	-	-	-	-	-	
Stacking Chair, Sled  	Plastic Shell, Seat Pad	VR	50	1	20	18.7W x 21.8D x 33.1H	0.4	7	622	652	668	685	701	718	738	753	775	803	836	870	902	934	789	819	977	1,012	1,142	
	Wood Shell, Seat Pad	VR	50	1	60	18.7W x 21.8D x 33.1H	0.4	7	1,388	1,418	1,434	1,451	1,467	1,484	1,504	1,519	1,541	1,569	1,602	1,636	1,668	1,700	1,555	1,585	1,743	1,778	1,908	
Stacking Chair, Sled  	Plastic Shell, Loose Seat Pad	VR	50	1	25	18.7W x 21.8D x 33.1H	0.4	7	662	692	709	724	742	757	776	793	815	843	876	909	941	974	828	858	1,016	1,051	1,182	
	Wood Shell, Loose Seat Pad	VR	50	1	65	18.7W x 21.8D x 33.1H	0.4	7	1,428	1,458	1,475	1,490	1,508	1,523	1,542	1,559	1,581	1,609	1,642	1,675	1,707	1,740	1,594	1,624	1,782	1,817	1,948	
Stacking Chair, Sled  	Plastic Shell, Upholstered Liner	VR	50	1	30	19.6W x 22.7D x 33.6H	0.8	11	756	817	848	880	915	947	982	1,019	1,061	1,116	1,182	1,247	1,313	1,379	1,029	1,084	1,343	1,401	1,616	
Stacking Chair, Sled  	Fully Upholstered	VR	50	1	40	19.6W x 22.7D x 33.6H	1.4	16	848	954	1,011	1,067	1,126	1,182	1,247	1,309	1,382	1,479	1,595	1,710	1,823	1,938	-	-	-	-	-	

To Order Select Below

1. Series/Style/Arm

<input type="radio"/>	VR501
-----------------------	-------

Verve Stacking Chair, Sled

Stacking on Floor:
8 high - Verve Plastic
5 high - Verve Wood
5 high - Verve Wood w/ Uph.

Stacking on Dolly:
14 high - Verve Plastic
14 high - Verve Wood
10 high - Verve Wood w/ Uph.

2. Upholstery

<input type="radio"/>	10	PLASTIC SHELL
<input type="radio"/>	20	PLASTIC SHELL, SEAT PAD
<input type="radio"/>	25	PLASTIC SHELL, LOOSE SEAT PAD
<input type="radio"/>	30	PLASTIC SHELL, UPHOLSTERED LINER
<input type="radio"/>	40	FULLY UPHOLSTERED
<input type="radio"/>	50	WOOD SHELL
<input type="radio"/>	60	WOOD SHELL, SEAT PAD
<input type="radio"/>	65	WOOD SHELL, LOOSE SEAT PAD

3. Glide

<input type="radio"/>	Glide
<input type="radio"/>	PG PLASTIC GLIDES
<input type="radio"/>	FG PLASTIC GLIDES WITH FELT PADS

4. Shell Finish

<input type="radio"/>	Plastic
<input type="radio"/>	01 BLACK MATTE
<input type="radio"/>	02 MILK
<input type="radio"/>	03 LIGHT GRAY
<input type="radio"/>	06 RED
<input type="radio"/>	10 NAVY
<input type="radio"/>	12 DARK GRAY
<input type="radio"/>	15 PALE YELLOW
<input type="radio"/>	16 DUSTY PINK
<input type="radio"/>	17 MEADOW GREEN
<input type="radio"/>	18 SOFT BLUE
<input type="radio"/>	19 SAND
<input type="radio"/>	Wood
<input type="radio"/>	DZ01 FLAT CUT WALNUT
<input type="radio"/>	DZ02 RIFT CUT OAK

5. Frame Finish

<input type="radio"/>	Powder Coat
<input type="radio"/>	BL BLUE
<input type="radio"/>	BM BLACK MATTE
<input type="radio"/>	BR BRASS
<input type="radio"/>	BT BLACK TWILIGHT
<input type="radio"/>	CP CHAMPAGNE
<input type="radio"/>	DB DARK BRONZE
<input type="radio"/>	DG DARK GRAY
<input type="radio"/>	DP DUSTY PINK
<input type="radio"/>	FG FOREST GREEN
<input type="radio"/>	Other
<input type="radio"/>	CH CHROME
<input type="radio"/>	LG LIGHT GRAY
<input type="radio"/>	MG MEADOW GREEN
<input type="radio"/>	MK MILK
<input type="radio"/>	MS METALLIC SILVER
<input type="radio"/>	NK NICKEL
<input type="radio"/>	NV NAVY
<input type="radio"/>	OR ORANGE
<input type="radio"/>	PY PALE YELLOW
<input type="radio"/>	RD RED
<input type="radio"/>	RO RED ORANGE
<input type="radio"/>	RR RUSTY RED
<input type="radio"/>	SB SOFT BLUE
<input type="radio"/>	SD SAND
<input type="radio"/>	TC TERRACOTTA
<input type="radio"/>	TP TAUPE
<input type="radio"/>	TS TEXTURED SLATE
<input type="radio"/>	YL YELLOW

Stylex will not warrant painted frames against damage caused by stacking. Only use dollies with chrome frames. We will not warrant powder coated Verve frames used on dollies against damage to the finish.

6. Options







<input type="radio"/>	CT	CONTRASTING THREAD
<input type="radio"/>	G	ARMLESS GANGING BRACKET +24
<input type="radio"/>	Accessories	
<input type="radio"/>	VRTD2	VERVE TRANSPORT DOLLY FOR SLED ARMLESS PLASTIC OR WOOD SHELL WITH UPHOLSTERY +1,208
<input type="radio"/>	VRTD3	VERVE TRANSPORT DOLLY FOR SLED ARMLESS PLASTIC OR WOOD SHELL +1,208

7. Upholstery

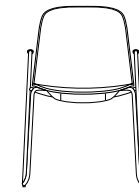
See general information section for details on textile program and COM/COL information.

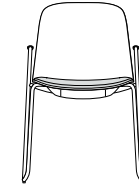
Verve

STACKING CHAIR: SLED, ARM

TITLE	SHELL/UPHOLSTERY	SERIES	FRAME	ARM	UPH	DIMENSIONS	COM	COL	Textile Upholstery Grades														Leather Upholstery Grades				
									YDG	SQFT	COM	A	B	C	D	E	F	G	H	I	J	K	L	M	W	X	Y
Stacking Chair, Sled, Arm	 Plastic Shell	VR	50	2	10	20.2W x 21.8D x 33.1H	-	-	474	-	-	-	-	-	-	-	-	-	-	-	-	-	-	-	-	-	-
	 Wood Shell	VR	50	2	50	20.2W x 21.8D x 33.1H	-	-	1,239	-	-	-	-	-	-	-	-	-	-	-	-	-	-	-	-	-	
Stacking Chair, Sled, Arm	 Plastic Shell, Seat Pad	VR	50	2	20	20.2W x 21.8D x 33.1H	0.4	7	647	677	693	710	726	743	763	778	800	828	861	895	927	959	814	844	1,002	1,037	1,167
	 Wood Shell, Seat Pad	VR	50	2	60	20.2W x 21.8D x 33.1H	0.4	7	1,413	1,443	1,459	1,476	1,492	1,509	1,529	1,544	1,566	1,594	1,627	1,661	1,693	1,725	1,580	1,610	1,768	1,803	1,933
Stacking Chair, Sled, Arm	 Plastic Shell, Loose Seat Pad	VR	50	2	25	20.2W x 21.8D x 33.1H	0.4	7	687	717	734	749	767	782	801	818	840	868	901	934	966	999	853	883	1,041	1,076	1,207
	 Wood Shell, Loose Seat Pad	VR	50	2	65	20.2W x 21.8D x 33.1H	0.4	7	1,453	1,483	1,500	1,515	1,533	1,548	1,567	1,584	1,606	1,634	1,667	1,700	1,732	1,765	1,619	1,649	1,807	1,842	1,973
Stacking Chair, Sled, Arm	 Plastic Shell, Upholstered Liner	VR	50	2	30	20.2W x 22.7D x 33.6H	0.8	11	781	842	873	905	940	972	1,007	1,044	1,086	1,141	1,207	1,272	1,338	1,404	1,054	1,109	1,368	1,426	1,641
Stacking Chair, Sled, Arm	 Fully Upholstered	VR	50	2	40	20.2W x 22.7D x 33.6H	1.4	16	873	979	1,036	1,092	1,151	1,207	1,272	1,334	1,407	1,504	1,620	1,735	1,848	1,963	-	-	-	-	-

To Order Select Below

1. Series/Style/Arm

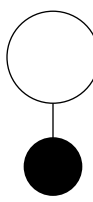

VR502

Verve Stacking Chair, Sled, Arm

Stacking on Floor:
8 high - Verve Plastic
5 high - Verve Wood
5 high - Verve Wood w/ Uph.

Stacking on Dolly:
14 high - Verve Plastic
14 high - Verve Wood
10 high - Verve Wood w/ Uph.

2. Upholstery

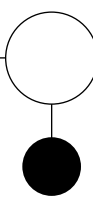

10	PLASTIC SHELL
20	PLASTIC SHELL, SEAT PAD
25	PLASTIC SHELL, LOOSE SEAT PAD
30	PLASTIC SHELL, UPHOLSTERED LINER
40	FULLY UPHOLSTERED
50	WOOD SHELL
60	WOOD SHELL, SEAT PAD
65	WOOD SHELL, LOOSE SEAT PAD

3. Glide

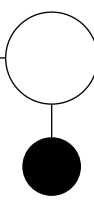

PG	PLASTIC GLIDES
	PLASTIC GLIDES WITH FELT PADS
FG	

4. Shell Finish

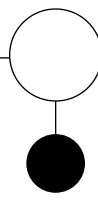

01	BLACK MATTE
02	MILK
03	LIGHT GRAY
06	RED
10	NAVY
12	DARK GRAY
15	PALE YELLOW
16	DUSTY PINK
17	MEADOW GREEN
18	SOFT BLUE
19	SAND

DZ01	FLAT CUT WALNUT
DZ02	RIFT CUT OAK

5. Frame Finish

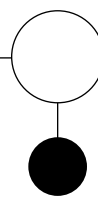

BL	BLUE
BM	BLACK MATTE
BR	BRASS
BT	BLACK TWILIGHT
CP	CHAMPAGNE
DB	DARK BRONZE
DG	DARK GRAY
DP	DUSTY PINK
FG	FOREST GREEN
LG	LIGHT GRAY
MG	MEADOW GREEN
MK	MILK
MS	METALLIC SILVER
NK	NICKEL
NV	NAVY
OR	ORANGE
PY	PALE YELLOW
RD	RED
RO	RED ORANGE
RR	RUSTY RED
SB	SOFT BLUE
SD	SAND
TC	TERRACOTTA
TP	TAUPE
TS	TEXTURED SLATE
YL	YELLOW

CH	CHROME
----	--------

Stylex will not warrant painted frames against damage caused by stacking. Only use dollies with chrome frames. We will not warrant powder coated Verve frames used on dollies against damage to the finish.

6. Options

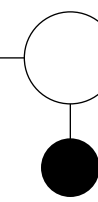

CT CONTRASTING THREAD

Accessories

VERVE TRANSPORT DOLLY FOR SLED WITH ARM +1,208

7. Upholstery

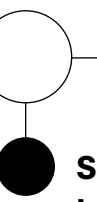

See general information section for details on textile program and COM/COL information.

Verve

STOOL: BAR FOUR LEG

TITLE	SHELL/UPHOLSTERY	SERIES	FRAME	ARM	UPH	DIMENSIONS	COM	COL	Textile Upholstery Grades														Leather Upholstery Grades					
									YDG	SQFT	COM	A	B	C	D	E	F	G	H	I	J	K	L	M	W	X	Y	E1
Stool, Four Leg Bar	Plastic Shell	VR	70	1	10	18.7W x 21.9D x 45.7H	-	-	710	-	-	-	-	-	-	-	-	-	-	-	-	-	-	-	-	-	-	-
	Wood Shell	VR	70	1	50	18.7W x 21.9D x 45.7H	-	-	1,475	-	-	-	-	-	-	-	-	-	-	-	-	-	-	-	-	-	-	-
Stool, Four Leg Bar	Plastic Shell, Seat Pad	VR	70	1	20	18.7W x 21.9D x 45.7H	0.4	7	883	913	929	946	962	979	999	1,014	1,036	1,064	1,097	1,131	1,163	1,195	1,050	1,080	1,238	1,273	1,403	
	Wood Shell, Seat Pad	VR	70	1	60	18.7W x 21.9D x 45.7H	0.4	7	1,649	1,679	1,695	1,712	1,728	1,745	1,765	1,780	1,802	1,830	1,863	1,897	1,929	1,961	1,816	1,846	2,004	2,039	2,169	
Stool, Four Leg Bar	Plastic Shell, Loose Seat Pad	VR	70	1	25	18.7W x 21.9D x 45.7H	0.4	7	923	953	970	985	1,003	1,018	1,037	1,054	1,076	1,104	1,137	1,170	1,202	1,235	1,089	1,119	1,277	1,312	1,443	
	Wood Shell, Loose Seat Pad	VR	70	1	65	18.7W x 21.9D x 45.7H	0.4	7	1,689	1,719	1,736	1,751	1,769	1,784	1,803	1,820	1,842	1,870	1,903	1,936	1,968	2,001	1,855	1,885	2,043	2,078	2,209	
Stool, Four Leg Bar	Plastic Shell, Upholstered Liner	VR	70	1	30	19.6W x 22.8D x 46.2H	0.8	11	1,017	1,078	1,109	1,141	1,176	1,208	1,243	1,280	1,322	1,377	1,443	1,508	1,574	1,640	1,290	1,345	1,604	1,662	1,877	
Stool, Four Leg Bar	Fully Upholstered	VR	70	1	40	19.6W x 22.8D x 46.2H	1.4	16	1,109	1,215	1,272	1,328	1,387	1,443	1,508	1,570	1,643	1,740	1,856	1,971	2,084	2,199	-	-	-	-	-	

To Order Select Below

1. Series/Style/Arm

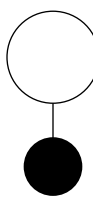

VR701

Verve Stool Four Leg Bar

2. Upholstery

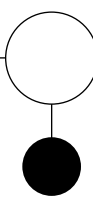

- 10 PLASTIC SHELL
- 20 PLASTIC SHELL, SEAT PAD
- 25 PLASTIC SHELL, LOOSE SEAT PAD
- 30 PLASTIC SHELL, UPHOLSTERED LINER
- 40 FULLY UPHOLSTERED
- 50 WOOD SHELL
- 60 WOOD SHELL, SEAT PAD
- 65 WOOD SHELL, LOOSE SEAT PAD

3. Glide

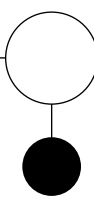

- PG PLASTIC GLIDES
- FG PLASTIC GLIDES WITH FELT PADS

4. Shell Finish

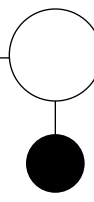

- Plastic**
 - 01 BLACK MATTE
 - 02 MILK
 - 03 LIGHT GRAY
 - 06 RED
 - 10 NAVY
 - 12 DARK GRAY
 - 15 PALE YELLOW
 - 16 DUSTY PINK
 - 17 MEADOW GREEN
 - 18 SOFT BLUE
 - 19 SAND
- Wood**
 - DZ01 FLAT CUT WALNUT
 - DZ02 RIFT CUT OAK

5. Frame Finish

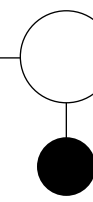

- Powder Coat**
 - BL BLUE
 - BM BLACK MATTE
 - BR BRASS
 - BT BLACK TWILIGHT
 - CP CHAMPAGNE
 - DB DARK BRONZE
 - DG DARK GRAY
 - DP DUSTY PINK
 - FG FOREST GREEN
 - LG LIGHT GRAY
 - MG MEADOW GREEN
 - MK MILK
 - MS METALLIC SILVER
 - NK NICKEL
 - NV NAVY
 - OR ORANGE
 - PY PALE YELLOW
 - RD RED
 - RO RED ORANGE
 - RR RUSTY RED
 - SB SOFT BLUE
 - SD SAND
 - TC TERRACOTTA
 - TP TAUPE
 - TS TEXTURED SLATE
 - YL YELLOW
- Other**
 - CH CHROME **+79**

6. Options

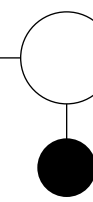

- CT CONTRASTING THREAD

7. Upholstery

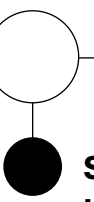

See general information section for details on textile program and COM/COL information.

Verve

STOOL: COUNTER FOUR LEG

TITLE	SHELL/UPHOLSTERY	SERIES	FRAME	ARM	UPH	DIMENSIONS	COM	COL	Textile Upholstery Grades														Leather Upholstery Grades				
									YDG	SQFT	COM	A	B	C	D	E	F	G	H	I	J	K	L	M	W	X	Y
Stool, Four Leg Counter	Plastic Shell	VR	90	1	10	18.7W x 21.8D x 40.8H	-	-	710	-	-	-	-	-	-	-	-	-	-	-	-	-	-	-	-	-	-
	Wood Shell	VR	90	1	50	18.7W x 21.8D x 40.8H	-	-	1,475	-	-	-	-	-	-	-	-	-	-	-	-	-	-	-	-	-	
Stool, Four Leg Counter	Plastic Shell, Seat Pad	VR	90	1	20	18.7W x 21.8D x 40.8H	0.4	7	883	913	929	946	962	979	999	1,014	1,036	1,064	1,097	1,131	1,163	1,195	1,050	1,080	1,238	1,273	1,403
	Wood Shell, Seat Pad	VR	90	1	60	18.7W x 21.8D x 40.8H	0.4	7	1,649	1,679	1,695	1,712	1,728	1,745	1,765	1,780	1,802	1,830	1,863	1,897	1,929	1,961	1,816	1,846	2,004	2,039	2,169
Stool, Four Leg Counter	Plastic Shell, Loose Seat Pad	VR	90	1	25	18.7W x 21.8D x 40.8H	0.4	7	923	953	970	985	1,003	1,018	1,037	1,054	1,076	1,104	1,137	1,170	1,202	1,235	1,089	1,119	1,277	1,312	1,443
	Wood Shell, Loose Seat Pad	VR	90	1	65	18.7W x 21.8D x 40.8H	0.4	7	1,689	1,719	1,736	1,751	1,769	1,784	1,803	1,820	1,842	1,870	1,903	1,936	1,968	2,001	1,855	1,885	2,043	2,078	2,209
Stool, Four Leg Counter	Plastic Shell, Upholstered Liner	VR	90	1	30	19.6W x 22.7D x 41.3H	0.8	11	1,017	1,078	1,109	1,141	1,176	1,208	1,243	1,280	1,322	1,377	1,443	1,508	1,574	1,640	1,290	1,345	1,604	1,662	1,877
Stool, Four Leg Counter	Fully Upholstered	VR	90	1	40	19.6W x 22.7D x 41.3H	1.4	16	1,109	1,215	1,272	1,328	1,387	1,443	1,508	1,570	1,643	1,740	1,856	1,971	2,084	2,199	-	-	-	-	-

To Order Select Below

1. Series/Style/Arm

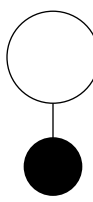

VR901

Verve Stool Four Leg Counter

2. Upholstery

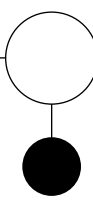

- 10 PLASTIC SHELL
- 20 PLASTIC SHELL, SEAT PAD
- 25 PLASTIC SHELL, LOOSE SEAT PAD
- 30 PLASTIC SHELL, UPHOLSTERED LINER
- 40 FULLY UPHOLSTERED
- 50 WOOD SHELL
- 60 WOOD SHELL, SEAT PAD
- 65 WOOD SHELL, LOOSE SEAT PAD

3. Glide

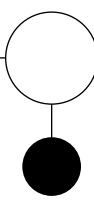

- Glide**
- PG PLASTIC GLIDES
- FG PLASTIC GLIDES WITH FELT PADS

4. Shell Finish

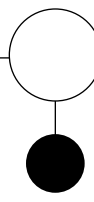

- Plastic**
 - 01 BLACK MATTE
 - 02 MILK
 - 03 LIGHT GRAY
 - 06 RED
 - 10 NAVY
 - 12 DARK GRAY
 - 15 PALE YELLOW
 - 16 DUSTY PINK
 - 17 MEADOW GREEN
 - 18 SOFT BLUE
 - 19 SAND
- Wood**
 - DZ01 FLAT CUT WALNUT
 - DZ02 RIFT CUT OAK

5. Frame Finish

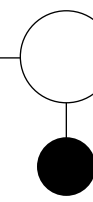

- Powder Coat**
 - BL BLUE
 - BM BLACK MATTE
 - BR BRASS
 - BT BLACK TWILIGHT
 - CP CHAMPAGNE
 - DB DARK BRONZE
 - DG DARK GRAY
 - DP DUSTY PINK
 - FG FOREST GREEN
 - LG LIGHT GRAY
 - MG MEADOW GREEN
 - MK MILK
 - MS METALLIC SILVER
 - NK NICKEL
 - NV NAVY
 - OR ORANGE
 - PY PALE YELLOW
 - RD RED
 - RO RED ORANGE
 - RR RUSTY RED
 - SB SOFT BLUE
 - SD SAND
 - TC TERRACOTTA
 - TP TAUPE
 - TS TEXTURED SLATE
 - YL YELLOW
- Other**
 - CH CHROME **+79**

6. Options

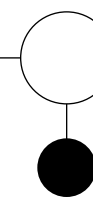

- CT CONTRASTING THREAD



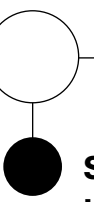

7. Upholstery

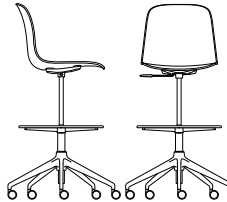
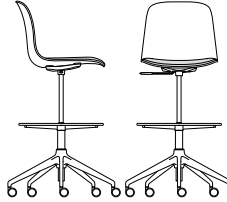

See general information section for details on textile program and COM/COL information.

Verve

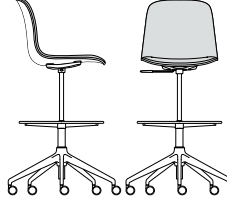
STOOL: BAR FIVE BLADE

TITLE	SHELL/UPHOLSTERY	SERIES	FRAME	ARM	UPH	DIMENSIONS	COM		Textile Upholstery Grades														Leather Upholstery Grades				
							YDG	SQFT	COM	A	B	C	D	E	F	G	H	I	J	K	L	M	W	X	Y	E1	E2
Stool, Five Blade Bar 	Plastic Shell	VR	35	1	10	29W x 29D x 38.5 -48.5H	-	-	782	-	-	-	-	-	-	-	-	-	-	-	-	-	-	-	-	-	-
	Wood Shell	VR	35	1	50	29W x 29D x 38.5 -48.5H	-	-	1,547	-	-	-	-	-	-	-	-	-	-	-	-	-	-	-	-	-	
Stool, Five Blade Bar 	Plastic Shell, Seat Pad	VR	35	1	20	29W x 29D x 38.5 -48.5H	0.4	7	955	985	1,001	1,018	1,034	1,051	1,071	1,086	1,108	1,136	1,169	1,203	1,235	1,267	1,122	1,152	1,310	1,345	1,475
	Wood Shell, Seat Pad	VR	35	1	60	29W x 29D x 38.5 -48.5H	0.4	7	1,721	1,751	1,767	1,784	1,800	1,817	1,837	1,852	1,874	1,902	1,935	1,969	2,001	2,033	1,888	1,918	2,076	2,111	2,241
Stool, Five Blade Bar 	Plastic Shell, Loose Seat Pad	VR	35	1	25	29W x 29D x 38.5 -48.5H	0.4	7	995	1,025	1,042	1,057	1,075	1,090	1,109	1,126	1,148	1,176	1,209	1,242	1,274	1,307	1,161	1,191	1,349	1,384	1,515
	Wood Shell, Loose Seat Pad	VR	35	1	65	29W x 29D x 38.5 -48.5H	0.4	7	1,761	1,791	1,808	1,823	1,841	1,856	1,875	1,892	1,914	1,942	1,975	2,008	2,040	2,073	1,927	1,957	2,115	2,150	2,281
Stool, Five Blade Bar 	Plastic Shell, Upholstered Liner	VR	35	1	30	29W x 29D x 39.5 -49.0H	0.8	11	1,089	1,150	1,181	1,213	1,248	1,280	1,315	1,352	1,394	1,449	1,515	1,580	1,646	1,712	1,362	1,417	1,676	1,734	1,949
Stool, Five Blade Bar 	Fully Upholstered	VR	35	1	40	29W x 29D x 39.5 -49.0H	1.4	16	1,181	1,287	1,344	1,400	1,459	1,515	1,580	1,642	1,715	1,812	1,928	2,043	2,156	2,271	-	-	-	-	-



To Order Select Below

<p>1. Series/Style/Arm</p> <p>VR351</p> <p>Verve Stool Five Blade Bar</p>	<p>2. Upholstery</p> <p>10 PLASTIC SHELL</p> <p>20 PLASTIC SHELL, SEAT PAD</p> <p>25 PLASTIC SHELL, LOOSE SEAT PAD</p> <p>30 PLASTIC SHELL, UPHOLSTERED LINER</p> <p>40 FULLY UPHOLSTERED</p> <p>50 WOOD SHELL</p> <p>60 WOOD SHELL, SEAT PAD</p> <p>65 WOOD SHELL, LOOSE SEAT PAD</p>	<p>3. Height</p> <p>BAR HEIGHT</p> <p>H HEIGHT</p>	<p>4. Caster or Glide</p> <p>Caster</p> <p>C1 HARD, BLACK</p> <p>C2 HARD, MILK WITH LIGHT GRAY TIRE</p> <p>C3 HARD, LIGHT GRAY</p> <p>CS1 SOFT, BLACK +42</p> <p>CS2 SOFT, MILK WITH LIGHT GRAY TIRE +42</p> <p>CS3 SOFT, LIGHT GRAY +42</p> <p>Glide</p> <p>PG PLASTIC GLIDES</p> <p>FG PLASTIC GLIDES WITH FELT PADS</p>	<p>5. Shell Finish</p> <p>Plastic</p> <p>01 BLACK MATTE</p> <p>02 MILK</p> <p>03 LIGHT GRAY</p> <p>06 RED</p> <p>10 NAVY</p> <p>12 DARK GRAY</p> <p>15 PALE YELLOW</p> <p>16 DUSTY PINK</p> <p>17 MEADOW GREEN</p> <p>18 SOFT BLUE</p> <p>19 SAND</p> <p>Wood</p> <p>DZ01 FLAT CUT WALNUT</p> <p>DZ02 RIFT CUT OAK</p>	<p>6. Frame Finish</p> <p>Powder Coat +53</p> <p>BL BLUE</p> <p>BM BLACK MATTE</p> <p>BR BRASS</p> <p>BT BLACK TWILIGHT</p> <p>CP CHAMPAGNE</p> <p>DB DARK BRONZE</p> <p>DG DARK GRAY</p> <p>DP DUSTY PINK</p> <p>FG FOREST GREEN</p> <p>LG LIGHT GRAY</p> <p>MG MEADOW GREEN</p> <p>MK MILK</p> <p>MS METALLIC SILVER</p> <p>NK NICKEL</p> <p>NV NAVY</p> <p>OR ORANGE</p> <p>PY PALE YELLOW</p> <p>RD RED</p> <p>Other</p> <p>AL POLISHED ALUMINUM</p>	<p>7. Options</p> <p>RO RED ORANGE</p> <p>RR RUSTY RED</p> <p>SB SOFT BLUE</p> <p>SD SAND</p> <p>TC TERRACOTTA</p> <p>TP TAUPE</p> <p>TS TEXTURED SLATE</p> <p>YL YELLOW</p> <p>CT CONTRASTING THREAD</p>	<p>8. Upholstery</p> <p>See general information section or details on textile program and COM/COL information.</p>
---	---	---	--	---	---	--	---

Cylinder and lever handles match caster color selected. On chairs with glides, cylinders and lever handles are black, unless Milk or Light Gray is the selected frame color. Exception: Polished Aluminum frames will ship with chrome cylinders.

Verve

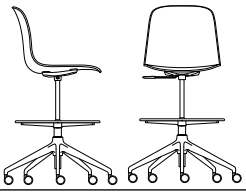
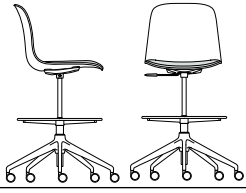
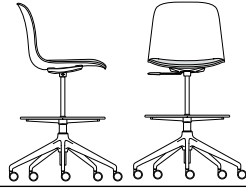
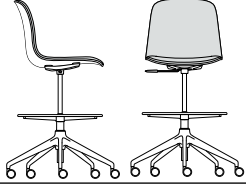
STOOL: COUNTER FIVE BLADE

TITLE	SHELL/UPHOLSTERY	SERIES	FRAME	ARM	UPH	DIMENSIONS	COM		Textile Upholstery Grades														Leather Upholstery Grades				
							YDG	SQFT	COM	A	B	C	D	E	F	G	H	I	J	K	L	M	W	X	Y	E1	E2
Stool, Five Blade Counter 	Plastic Shell	VR	35	1	10	29W x 29D x 36.0 -43.7H	-	-	782	-	-	-	-	-	-	-	-	-	-	-	-	-	-	-	-	-	-
	Wood Shell	VR	35	1	50	29W x 29D x 36.0 -43.7H	-	-	1,547	-	-	-	-	-	-	-	-	-	-	-	-	-	-	-	-	-	
Stool, Five Blade Counter 	Plastic Shell, Seat Pad	VR	35	1	20	29W x 29D x 36.0 -43.7H	0.4	7	955	985	1,001	1,018	1,034	1,051	1,071	1,086	1,108	1,136	1,169	1,203	1,235	1,267	1,122	1,152	1,310	1,345	1,475
	Wood Shell, Seat Pad	VR	35	1	60	29W x 29D x 36.0 -43.7H	0.4	7	1,721	1,751	1,767	1,784	1,800	1,817	1,837	1,852	1,874	1,902	1,935	1,969	2,001	2,033	1,888	1,918	2,076	2,111	2,241
Stool, Five Blade Counter 	Plastic Shell, Loose Seat Pad	VR	35	1	25	29W x 29D x 36.0 -43.7H	0.4	7	995	1,025	1,042	1,057	1,075	1,090	1,109	1,126	1,148	1,176	1,209	1,242	1,274	1,307	1,161	1,191	1,349	1,384	1,515
	Wood Shell, Loose Seat Pad	VR	35	1	65	29W x 29D x 36.0 -43.7H	0.4	7	1,761	1,791	1,808	1,823	1,841	1,856	1,875	1,892	1,914	1,942	1,975	2,008	2,040	2,073	1,927	1,957	2,115	2,150	2,281
Stool, Five Blade Counter 	Plastic Shell, Upholstered Liner	VR	35	1	30	29W x 29D x 36.5 -44.2H	0.8	11	1,089	1,150	1,181	1,213	1,248	1,280	1,315	1,352	1,394	1,449	1,515	1,580	1,646	1,712	1,362	1,417	1,676	1,734	1,949
Stool, Five Blade Counter 	Fully Upholstered	VR	35	1	40	29W x 29D x 36.5 -44.2H	1.4	16	1,181	1,287	1,344	1,400	1,459	1,515	1,580	1,642	1,715	1,812	1,928	2,043	2,156	2,271	-	-	-	-	-





To Order Select Below

<p>1. Series/Style/Arm</p> <p>VR351</p> <p>Verve Stool Five Blade Counter</p>	<p>2. Upholstery</p> <p>10 PLASTIC SHELL</p> <p>20 PLASTIC SHELL, SEAT PAD</p> <p>25 PLASTIC SHELL, LOOSE SEAT PAD</p> <p>30 PLASTIC SHELL, UPHOLSTERED LINER</p> <p>40 FULLY UPHOLSTERED</p> <p>50 WOOD SHELL</p> <p>60 WOOD SHELL, SEAT PAD</p> <p>65 WOOD SHELL, LOOSE SEAT PAD</p>	<p>3. Height</p> <p>M COUNTER HEIGHT</p>	<p>4. Caster or Glide</p> <p>Caster</p> <p>C1 HARD, BLACK</p> <p>C2 HARD, MILK WITH LIGHT GRAY TIRE</p> <p>C3 HARD, LIGHT GRAY</p> <p>CS1 SOFT, BLACK +42</p> <p>CS2 SOFT, MILK WITH LIGHT GRAY TIRE +42</p> <p>CS3 SOFT, LIGHT GRAY +42</p> <p>Glide</p> <p>PG PLASTIC GLIDES</p> <p>FG PLASTIC GLIDES WITH FELT PADS</p>	<p>5. Shell Finish</p> <p>Plastic</p> <p>01 BLACK MATTE</p> <p>02 MILK</p> <p>03 LIGHT GRAY</p> <p>06 RED</p> <p>10 NAVY</p> <p>12 DARK GRAY</p> <p>15 PALE YELLOW</p> <p>16 DUSTY PINK</p> <p>17 MEADOW GREEN</p> <p>18 SOFT BLUE</p> <p>19 SAND</p> <p>Wood</p> <p>DZ01 FLAT CUT WALNUT</p> <p>DZ02 RIFT CUT OAK</p>	<p>6. Frame Finish</p> <p>Powder Coat +53</p> <p>BL BLUE</p> <p>BM BLACK MATTE</p> <p>BR BRASS</p> <p>BT BLACK TWILIGHT</p> <p>CP CHAMPAGNE</p> <p>DB DARK BRONZE</p> <p>DG DARK GRAY</p> <p>DP DUSTY PINK</p> <p>FG FOREST GREEN</p> <p>LG LIGHT GRAY</p> <p>MG MEADOW GREEN</p> <p>MK MILK</p> <p>MS METALLIC SILVER</p> <p>NK NICKEL</p> <p>NV NAVY</p> <p>OR ORANGE</p> <p>PY PALE YELLOW</p> <p>RD RED</p> <p>Other</p> <p>AL POLISHED ALUMINUM</p>	<p>7. Options</p> <p>CT CONTRASTING THREAD</p>	<p>8. Upholstery</p> <p>See general information section or details on textile program and COM/COL information.</p>
---	---	---	--	---	---	---	---

Cylinder and lever handles match caster color selected. On chairs with glides, cylinders and lever handles are black, unless Milk or Light Gray is the selected frame color. Exception: Polished Aluminum frames will ship with chrome cylinders.

Verve

STOOL: BAR FIVE BLADE, ARM

TITLE	SHELL/UPHOLSTERY	SERIES	FRAME	ARM	UPH	DIMENSIONS	COM		Textile Upholstery Grades														Leather Upholstery Grades				
							YDG	SQFT	COM	A	B	C	D	E	F	G	H	I	J	K	L	M	W	X	Y	E1	E2
Stool, Five Blade Bar, Arm 	Plastic Shell	VR	35	2	10	29W x 29D x 38.5 -48.5H	-	-	948	-	-	-	-	-	-	-	-	-	-	-	-	-	-	-	-	-	-
	Wood Shell	VR	35	2	50	29W x 29D x 38.5 -48.5H	-	-	1,713	-	-	-	-	-	-	-	-	-	-	-	-	-	-	-	-	-	
Stool, Five Blade Bar, Arm 	Plastic Shell, Seat Pad	VR	35	2	20	29W x 29D x 38.5 -48.5H	0.4	7	1,121	1,151	1,167	1,184	1,200	1,217	1,237	1,252	1,274	1,302	1,335	1,369	1,401	1,433	1,288	1,318	1,476	1,511	1,641
	Wood Shell, Seat Pad	VR	35	2	60	29W x 29D x 38.5 -48.5H	0.4	7	1,887	1,917	1,933	1,950	1,966	1,983	2,003	2,018	2,040	2,068	2,101	2,135	2,167	2,199	2,054	2,084	2,242	2,277	2,407
Stool, Five Blade Bar, Arm 	Plastic Shell, Loose Seat Pad	VR	35	2	25	29W x 29D x 38.5 -48.5H	0.4	7	1,161	1,191	1,208	1,223	1,241	1,256	1,275	1,292	1,314	1,342	1,375	1,408	1,440	1,473	1,327	1,357	1,515	1,550	1,681
	Wood Shell, Loose Seat Pad	VR	35	2	65	29W x 29D x 38.5 -48.5H	0.4	7	1,927	1,957	1,974	1,989	2,007	2,022	2,041	2,058	2,080	2,108	2,141	2,174	2,206	2,239	2,093	2,123	2,281	2,316	2,447
Stool, Five Blade Bar, Arm 	Plastic Shell, Upholstered Liner	VR	35	2	30	29W x 29D x 39.5 -49.0H	0.8	11	1,255	1,316	1,347	1,379	1,414	1,446	1,481	1,518	1,560	1,615	1,681	1,746	1,812	1,878	1,528	1,583	1,842	1,900	2,115
Stool, Five Blade Bar, Arm 	Fully Upholstered	VR	35	2	40	29W x 29D x 39.5 -49.0H	1.4	16	1,347	1,453	1,510	1,566	1,625	1,681	1,746	1,808	1,881	1,978	2,094	2,209	2,322	2,437	-	-	-	-	-





To Order Select Below

<p>1. Series/Style/Arm</p> <p>VR352</p> <p>Verve Stool Five Blade Bar, Arm</p>	<p>2. Upholstery</p> <p>10 PLASTIC SHELL</p> <p>20 PLASTIC SHELL, SEAT PAD</p> <p>25 PLASTIC SHELL, LOOSE SEAT PAD</p> <p>30 PLASTIC SHELL, UPHOLSTERED LINER</p> <p>40 FULLY UPHOLSTERED</p> <p>50 WOOD SHELL</p> <p>60 WOOD SHELL, SEAT PAD</p> <p>65 WOOD SHELL, LOOSE SEAT PAD</p>	<p>3. Height</p> <p>BAR HEIGHT</p> <p>H HEIGHT</p>	<p>4. Caster or Glide</p> <p>Caster</p> <p>C1 HARD, BLACK</p> <p>C2 HARD, MILK WITH LIGHT GRAY TIRE</p> <p>C3 HARD, LIGHT GRAY</p> <p>CS1 SOFT, BLACK +42</p> <p>CS2 SOFT, MILK WITH LIGHT GRAY TIRE +42</p> <p>CS3 SOFT, LIGHT GRAY +42</p> <p>Glide</p> <p>PG PLASTIC GLIDES</p> <p>FG PLASTIC GLIDES WITH FELT PADS</p>	<p>5. Shell Finish</p> <p>Plastic</p> <p>01 BLACK MATTE</p> <p>02 MILK</p> <p>03 LIGHT GRAY</p> <p>06 RED</p> <p>10 NAVY</p> <p>12 DARK GRAY</p> <p>15 PALE YELLOW</p> <p>16 DUSTY PINK</p> <p>17 MEADOW GREEN</p> <p>18 SOFT BLUE</p> <p>19 SAND</p> <p>Wood</p> <p>DZ01 FLAT CUT WALNUT</p> <p>DZ02 RIFT CUT OAK</p>	<p>6. Frame Finish</p> <p>Powder Coat +65</p> <p>BL BLUE</p> <p>BM BLACK MATTE</p> <p>BR BRASS</p> <p>BT BLACK TWILIGHT</p> <p>CP CHAMPAGNE</p> <p>DB DARK BRONZE</p> <p>DG DARK GRAY</p> <p>DP DUSTY PINK</p> <p>FG FOREST GREEN</p> <p>LG LIGHT GRAY</p> <p>MG MEADOW GREEN</p> <p>MK MILK</p> <p>MS METALLIC SILVER</p> <p>NK NICKEL</p> <p>NV NAVY</p> <p>OR ORANGE</p> <p>PY PALE YELLOW</p> <p>RD RED</p> <p>Other</p> <p>AL POLISHED ALUMINUM</p>	<p>7. Options</p> <p>CONTRASTING THREAD</p> <p>CT THREAD</p>	<p>8. Upholstery</p> <p>See general information section or details on textile program and COM/COL information.</p>
--	---	---	--	---	---	---	---

Cylinder and lever handles match caster color selected. On chairs with glides, cylinders and lever handles are black, unless Milk or Light Gray is the selected frame color. Exception: Polished Aluminum frames will ship with chrome cylinders.

Verve

STOOL: COUNTER FIVE BLADE, ARM

TITLE	SHELL/UPHOLSTERY	SERIES	FRAME	ARM	UPH	DIMENSIONS	COM	COL	Textile Upholstery Grades														Leather Upholstery Grades				
									YDG	SQFT	COM	A	B	C	D	E	F	G	H	I	J	K	L	M	W	X	Y
Stool, Five Blade Counter, Arm 	Plastic Shell	VR	35	2	10	29W x 29D x 36.0 -43.7H	-	-	948	-	-	-	-	-	-	-	-	-	-	-	-	-	-	-	-	-	-
	Wood Shell	VR	35	2	50	29W x 29D x 36.0 -43.7H	-	-	1,713	-	-	-	-	-	-	-	-	-	-	-	-	-	-	-	-	-	
Stool, Five Blade Counter, Arm 	Plastic Shell, Seat Pad	VR	35	2	20	29W x 29D x 36.0 -43.7H	0.4	7	1,121	1,151	1,167	1,184	1,200	1,217	1,237	1,252	1,274	1,302	1,335	1,369	1,401	1,433	1,288	1,318	1,476	1,511	1,641
	Wood Shell, Seat Pad	VR	35	2	60	29W x 29D x 36.0 -43.7H	0.4	7	1,887	1,917	1,933	1,950	1,966	1,983	2,003	2,018	2,040	2,068	2,101	2,135	2,167	2,199	2,054	2,084	2,242	2,277	2,407
Stool, Five Blade Counter, Arm 	Plastic Shell, Loose Seat Pad	VR	35	2	25	29W x 29D x 36.0 -43.7H	0.4	7	1,161	1,191	1,208	1,223	1,241	1,256	1,275	1,292	1,314	1,342	1,375	1,408	1,440	1,473	1,327	1,357	1,515	1,550	1,681
	Wood Shell, Loose Seat Pad	VR	35	2	65	29W x 29D x 36.0 -43.7H	0.4	7	1,927	1,957	1,974	1,989	2,007	2,022	2,041	2,058	2,080	2,108	2,141	2,174	2,206	2,239	2,093	2,123	2,281	2,316	2,447
Stool, Five Blade Counter, Arm 	Plastic Shell, Upholstered Liner	VR	35	2	30	29W x 29D x 36.5 -44.2H	0.8	11	1,255	1,316	1,347	1,379	1,414	1,446	1,481	1,518	1,560	1,615	1,681	1,746	1,812	1,878	1,528	1,583	1,842	1,900	2,115
Stool, Five Blade Counter, Arm 	Fully Upholstered	VR	35	2	40	29W x 29D x 36.5 -44.2H	1.4	16	1,347	1,453	1,510	1,566	1,625	1,681	1,746	1,808	1,881	1,978	2,094	2,209	2,322	2,437	-	-	-	-	-

To Order Select Below

<p>1. Series/Style/Arm</p> <p>VR352</p> <p>Verve Stool Five Blade Counter, Arm</p>	<p>2. Upholstery</p> <p>10 PLASTIC SHELL</p> <p>20 PLASTIC SHELL, SEAT PAD</p> <p>25 PLASTIC SHELL, LOOSE SEAT PAD</p> <p>30 PLASTIC SHELL, UPHOLSTERED LINER</p> <p>40 FULLY UPHOLSTERED</p> <p>50 WOOD SHELL</p> <p>60 WOOD SHELL, SEAT PAD</p> <p>65 WOOD SHELL, LOOSE SEAT PAD</p>	<p>3. Height</p> <p>M COUNTER HEIGHT</p>	<p>4. Caster or Glide</p> <p>Caster</p> <p>C1 HARD, BLACK</p> <p>C2 HARD, MILK WITH LIGHT GRAY TIRE</p> <p>C3 HARD, LIGHT GRAY</p> <p>CS1 SOFT, BLACK +42</p> <p>CS2 SOFT, MILK WITH LIGHT GRAY TIRE +42</p> <p>CS3 SOFT, LIGHT GRAY +42</p> <p>Glide</p> <p>PG PLASTIC GLIDES</p> <p>FG PLASTIC GLIDES WITH FELT PADS</p>	<p>5. Shell Finish</p> <p>Plastic</p> <p>01 BLACK MATTE</p> <p>02 MILK</p> <p>03 LIGHT GRAY</p> <p>06 RED</p> <p>10 NAVY</p> <p>12 DARK GRAY</p> <p>15 PALE YELLOW</p> <p>16 DUSTY PINK</p> <p>17 MEADOW GREEN</p> <p>18 SOFT BLUE</p> <p>19 SAND</p> <p>Wood</p> <p>DZ01 FLAT CUT WALNUT</p> <p>DZ02 RIFT CUT OAK</p>	<p>6. Frame Finish</p> <p>Powder Coat +65</p> <p>BL BLUE</p> <p>BM BLACK MATTE</p> <p>BR BRASS</p> <p>BT BLACK TWILIGHT</p> <p>CP CHAMPAGNE</p> <p>DB DARK BRONZE</p> <p>DG DARK GRAY</p> <p>DP DUSTY PINK</p> <p>FG FOREST GREEN</p> <p>LG LIGHT GRAY</p> <p>MG MEADOW GREEN</p> <p>MK MILK</p> <p>MS METALLIC SILVER</p> <p>NK NICKEL</p> <p>NV NAVY</p> <p>OR ORANGE</p> <p>PY PALE YELLOW</p> <p>RD RED</p> <p>Other</p> <p>AL POLISHED ALUMINUM</p>	<p>7. Options</p> <p>CT CONTRASTING THREAD</p>	<p>8. Upholstery</p> <p>See general information section or details on textile program and COM/COL information.</p>
--	---	---	--	---	---	---	---

Cylinder and lever handles match caster color selected. On chairs with glides, cylinders and lever handles are black, unless Milk or Light Gray is the selected frame color. Exception: Polished Aluminum frames will ship with chrome cylinders.

stylex

Welcome

PRICE LIST

Effective November 01, 2023

General Information

GENERAL INFORMATION

Terms

Net 30 days from date of invoice.
FOB Delanco, NJ

Damaged Shipments

All Stylex products are carefully inspected before they are packed in sturdy cartons designed to satisfy shipping requirements. Stylex is not responsible for damage in shipment. The transportation company assumes responsibility for delivering products to you in good condition when the bill of lading is signed. You protect yourself by refusing shipments showing damage or shortage until transportation company has noted on the delivery sheet the extent of damage or shortage. Concealed damage should be reported to the carrier as soon as discovered, but not later than 15 days after receiving shipment.

Return/Restocking Policy

Return shipments will not be accepted unless specifically authorized by Stylex in writing. The Return Authorization number should be clearly marked on the carton. The customer returning Stylex products is responsible for return shipping costs. Merchandise must be returned unused. Returned merchandise is subject to a 35% restocking fee.

Specials/Customs

Modifications to standard products will be considered for large runs. Contact Stylex for more information.

Design Changes

In keeping with modern manufacturing advances, Stylex reserves the right to incorporate minor modifications and design changes in products without notice.

Cancellation Policy

No charge prior to production except for inventory specifically requisitioned to fulfill the particular order. After production has begun, only actual costs incurred, including labor and material, will be billed to the customer.

WARRANTY

Except as provided below, Stylex warrants exclusively to the original Purchaser of our product that all parts, under normal use and service, will be free from defects in workmanship and material for a period of ten (10) years from the date of purchase. "Normal use and service" means that the product will be used in a typical office environment for 40-45 hours per week.

This warranty is subject to the following limitations, exclusions and provisions:

Wood components of plywood stacking chairs
(such as Brooks and Welcome)
5 years

Upholstery
(including mesh used for Click, F4, Insight, and Zephyr Mesh)
3 years

SAVA Mesh
10 years

COM Upholstery
No warranty
Stylex makes every effort to ensure that the COM Upholstery it approves is suitable for the intended use. Nevertheless, we will not warrant, and assume no responsibility for, the durability or tailoring quality of any COM or COL. If you have any concerns about the ultimate appearance of any covering, please order an upholstered sample.

Painted Stack Chair Frames
No Warranty
We will not warrant the finish of painted stack chair frames against damage from stacking. We recommend ordering chrome frames for chairs that will be stacked.

Felt Glides
No warranty
Due to the different surfaces on which felt glides may be used, we cannot warrant their durability over time.

If this product fails during normal use and service within the applicable warranty period (other than through normal wear and tear), please send a description of the relevant part and the nature of the defect, together with proof of purchase of the product, to Stylex at: Customer Service. c/o Stylex, P.O. Box 5038, Delanco, NJ 08075. PLEASE DO NOT RETURN PARTS OR THE PRODUCT TO STYLEX UNLESS INSTRUCTED TO DO SO BY STYLEX. Stylex will, at its option, either repair or replace the product or the part found defective by Stylex completely without charge for materials or labor. Purchaser may be required (at the option of Stylex) to return to Stylex at Purchaser's expense any defective part with all freight or shipping charges prepaid. The foregoing warranty shall be void if the product has been altered or repaired (other than by Stylex). The warranty does not cover damage to the product caused by accident, neglect, misuse, abuse, modification to the product by anyone other than Stylex or damage caused by use of the product for a purpose other than that for which it was designed. This warranty extends only to the original Purchaser of the product.

No Other Warranties

This warranty is in lieu of all other warranties, expressed or implied, including, but not limited to, implied warranties of merchantability and fitness for a particular purpose. The rights and remedies provided herein are the exclusive rights and remedies of the original purchaser of the product.

No Liability For Damages

In no event shall Stylex or its suppliers be responsible or liable for any special, indirect, consequential, or incidental damages. In no event shall the liability of Stylex exceed the actual purchase price paid to Stylex for the product.

Out of Warranty Products

For all products no longer covered by our warranty, please refer to our Design for Durability and Upgradability Policy. Contact Customer Service if you would like to purchase any replaceable components to further extend the life of any Stylex seating product. This warranty applies to all Stylex products purchased on April 13, 2018, and thereafter.

PRODUCT TAKE BACK PROGRAM

At Stylex, responsible stewardship of our products extends beyond their initial use. Our Product Take Back Program provides a practical solution for the end of our products' intended life cycle.

Through our partnership with ANEW, a 501(c)(3) nonprofit organization, we offer clients a comprehensive take-back solution for surplus office furniture and materials, regardless of their condition. ANEW's mission aligns with ours—to connect surplus resources with non-profits, public agencies, and underserved communities, minimizing landfill impact and maximizing corporate social responsibility.

By repurposing surplus items, we strengthen community networks and reduce environmental impact. Stylex proudly supports ANEW, integrating this partnership into our strategic sales strategy since 2014. Learn more at www.anewfound.org.

Initiate a Product Take Back through ANEW by emailing Stylex at info@stylexdesign.com. For additional end-of-life recovery options, refer to our Product Disassembly Instructions and End of Life Recovery Options documents, available in the Resources section of each product on our website. Together, let's build a sustainable future.

FREIGHT PROGRAM

Stylex offers a Guaranteed Freight Program, which provides the purchaser the ability to determine shipping and handling charges at the time of order. Freight charges will be calculated as a percentage of the net product price and added to the invoice at the time of shipment. The continental United States has been divided into three zones. Please use the map below to determine the freight charges for the product's destination. There is a minimum freight charge of \$150.

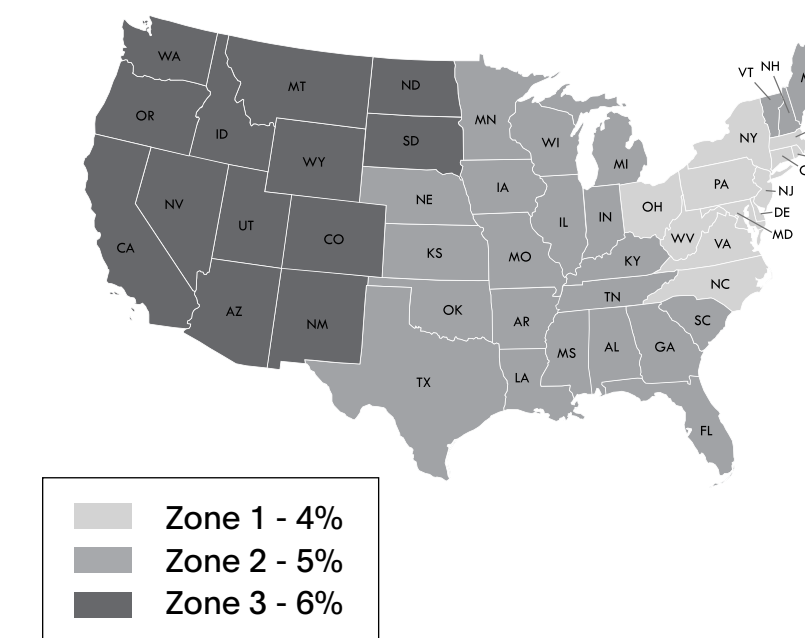

ZONE 1 - 4%

Connecticut
Delaware
New York
New Jersey
Maryland
Massachusetts
North Carolina
Ohio
Pennsylvania
Rhode Island
Virginia
Washington D.C.
West Virginia

ZONE 2 - 5%

Alabama
Arkansas
Canada, Ontario
Canada, Quebec
Florida
Georgia
Iowa
Illinois
Indiana
Kansas
Kentucky
Louisiana
Nebraska
New Hampshire
Oklahoma
Maine
Michigan
Minnesota
Mississippi
South Carolina
Tennessee
Texas
Vermont
Wisconsin

ZONE 3 - 6%

Arizona
California
Colorado
Idaho
Montana
Nevada
New Mexico
North Dakota
Oregon
South Dakota
Utah
Washington
Wyoming

Quote Per Project

Alaska
Hawaii
Canada
(outside Ontario & Quebec)
Mexico

General Information

TEXTILE PARTNERS & APPROVALS

Textile Partners

To customize your furniture performance needs and design vision, Stylex offers a wide selection of in-graded leathers and textiles from Grades A through Y. We've partnered with leading manufacturers on the options, focusing on color, price, durability, and construction. To view our partners and explore our digital carded program with broadly approved textiles, visit [this page](#). We stand by these textiles: They're tried and tested, and will effortlessly fit into any design aesthetic.

Textile Approvals

To view Stylex Approved Textile documents to determine specific product approval status, refer to our Product Tested Textiles documents, available in the Resources section of each product on our website.

CAL 117 AND 133 COMPLIANCE

CAL 117-2013

All Stylex seating satisfies the requirements of CAL 117-2013 so long as one of our standard or in-graded textiles is applied. COM textiles cannot be so guaranteed. Please contact the supplier of COM's directly to determine the fire retardancy of any COM supplied to us.

CAL 133

Most Stylex seating can be ordered to meet the requirements of CAL 133. When ordering, simply specify "CAL 133 compliance required". The upcharge for this option is \$54 list per yard. Please refer to the COM yardage of each model to determine the number of yards required. We do frequently require full-scale burn tests in order to certify CAL 133 before an order will be accepted. Such burn tests may increase normal lead times and do carry additional charges. Please contact customer service for details.

CUSTOMER'S OWN MATERIAL/LEATHER

Customer's own material (COM) and customer's own leather (COL) will generally be upholstered at the price designated in each product's price list. Please be advised, however, that we specifically reserve the right to charge a higher price when we determine that special circumstances, such as unusual repeats or challenging materials, present themselves. All orders for custom coverings must be approved by Stylex before they will be accepted for production. To submit proposed textile for approval, please use the COM form [here](#).

Special Note:

We assume no responsibility for the durability or tailoring quality of any COM or COL. Directional covers in particular may not meet your satisfaction due to the design of certain products. Please be advised that COM and COL orders are not subject to return. If you have doubts about the ultimate appearance of certain coverings, please order a sample done with that specific COM or COL. In addition, while we inspect textiles for mill imperfections, some are difficult to recognize. We cannot be responsible for defects, color inaccuracies, dye lot variations, or other flaws.

Under no circumstances will we be responsible for COM shortages, flaws, or other such problems. Finally, it is not our responsibility to police the receipt of COM's in order to meet delivery deadlines, and we assume our customers are aware of any undue delay in the shipment of their COM textiles.

COM textile and COL leather should be sent prepaid to: Stylex

**Attn: COM/COL - [Your PO #]
740 Coopertown Road
Delanco, NJ 08075**

Clearly mark textile or leather with the dealer's name, purchase order number, and furniture model number of the item to be covered. Actual furniture orders should include the same information, as well as a description of the textile or leather, including pattern and color number, in order to provide a cross reference.

Yardage requirements shown in the price list are based on non-directional goods of 54" width. Textiles less than 54" wide or those requiring matching (stripes, prints, or large patterned designs) call for additional yardage. We will be happy to supply yardage requirements for large quantities where economies may be realized.

Add the following yardage for stripes, plaids, or patterns with repeats:

Textile Width	Plain Textile	2-14" Repeat	15-24" Repeat	25-27" Repeat	28-36" Repeat
54"	0%	10%	15%	20%	25%
50"	10%	20%	25%	30%	35%
48"	15%	25%	30%	35%	40%
45"	40%	50%	55%	60%	65%
36"	50%	60%	65%	70%	75%

COM/COL FORM

To avoid delay in processing COM orders we request that you submit a sample of your COM textile stapled to this form which can be downloaded [here](#). If a textile has a stripe or design, the size of the repeat should be indicated. Please indicate the textile supplier's name, textile number, and color. Also indicate the Stylex product on which the textile will be used.

The textile supplier must indicate on his shipping labels the dealer name and purchase order number as well as the Stylex model number.

Please Note:

No order may be entered into production or have a shipping date assigned until all related COM is received at the factory.



CENTER OF STRIPE OR DESIGN

TOP	TOP
-----	-----

1. Size of Repeat

2. Textile Supplier

3. Textile Number

4. Color

5. Stylex Product

Welcome

Contents

<hr/>		<hr/>	
COLORS, MATERIALS, AND FINISHES	5	CHAIR: ARMLESS	9
<hr/>		<hr/>	
STATEMENT OF LINE	6	CHAIR: ARMS	10
<hr/>		<hr/>	
DIMENSIONS	7	STOOL: ARMLESS	11
<hr/>		<hr/>	
HOW TO ORDER	8	STOOL: ARMS	12
<hr/>		<hr/>	

CLICK THE TITLES ABOVE TO NAVIGATE THROUGH THE DOCUMENT
PRODUCT HEADERS ON SUBSEQUENT PAGES LINK BACK TO THIS PAGE

Welcome

COLORS, MATERIALS, AND FINISHES

POWDER PAINT LEG FINISHES

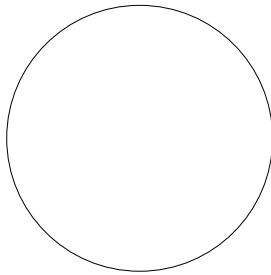

MILK
(MK)

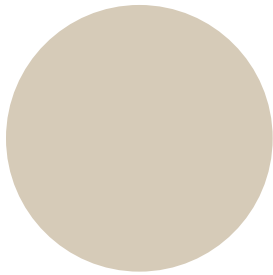

SAND
(SD)

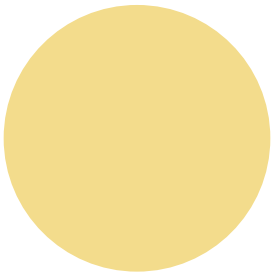

PALE YELLOW
(PY)

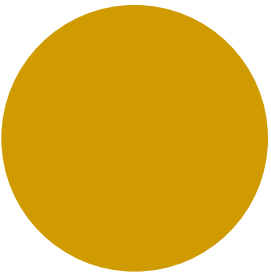

YELLOW
(YL)

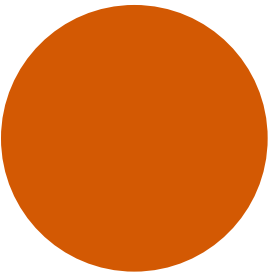

ORANGE
(OR)

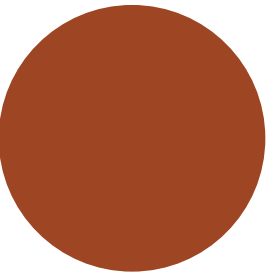

TERRACOTTA
(TC)

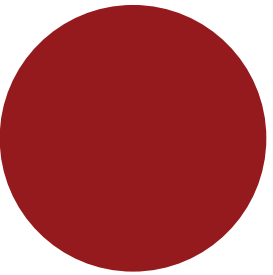

RED
(RD)

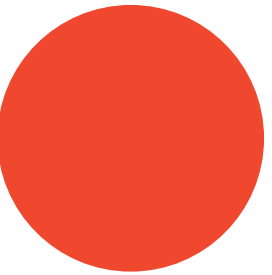

RED ORANGE
(RO)

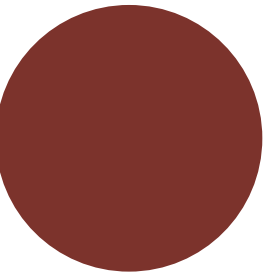

RUSTY RED
(RR)

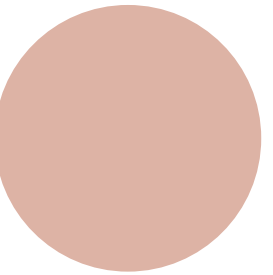

DUSTY PINK
(DP)

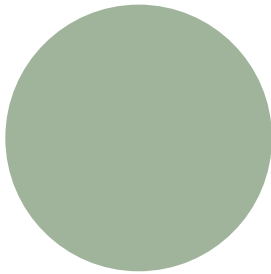

MEADOW GREEN
(MG)

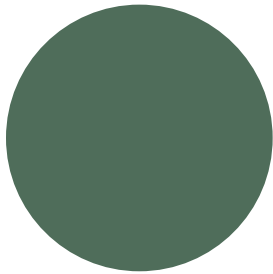

FOREST GREEN
(FG)

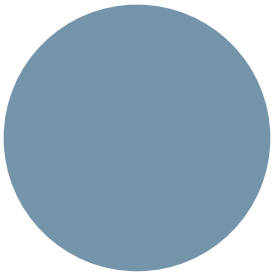

SOFT BLUE
(SB)

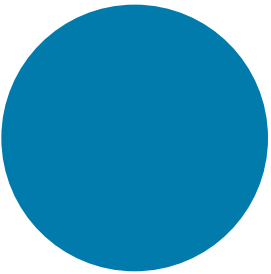

BLUE
(BL)

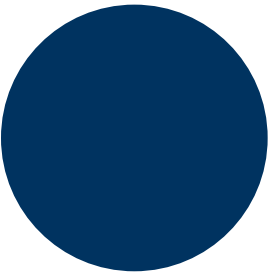

NAVY
(NV)

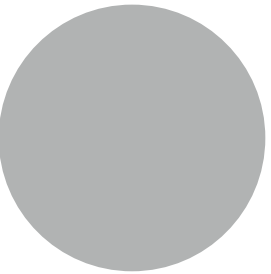

LIGHT GRAY
(LG)

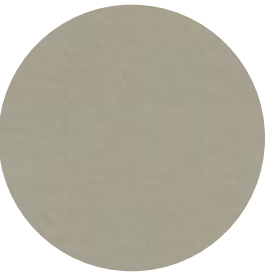

CHAMPAGNE
(CP)

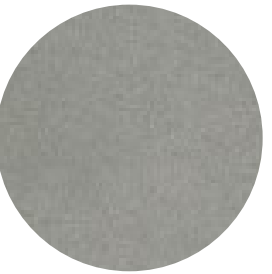

METALLIC SILVER
(MS)



NICKEL
(NK)

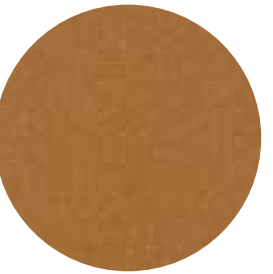

BRASS
(BR)

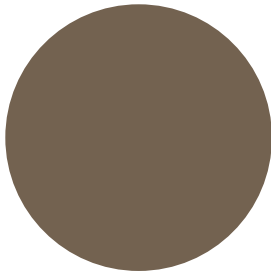

TAUPE
(TP)



DARK BRONZE
(DB)

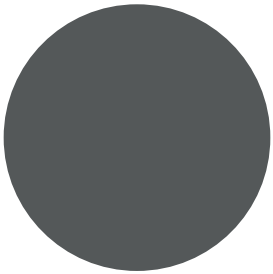

DARK GRAY
(DG)



TEXTURED SLATE
(TS)

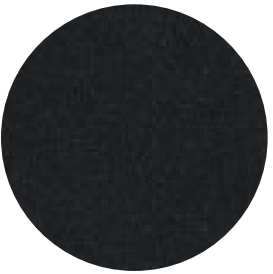

BLACK TWILIGHT
(BT)

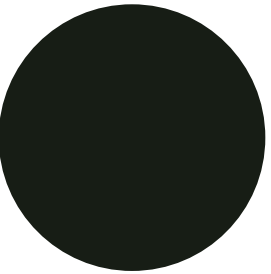

BLACK MATTE
(BM)



BRIGHT CHROME
(CH)

WOOD SEAT AND BACK FINISH



CLEAR MAPLE
(WL01)

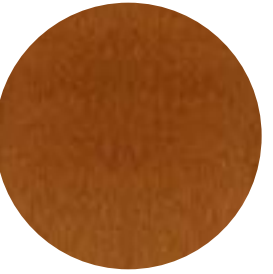

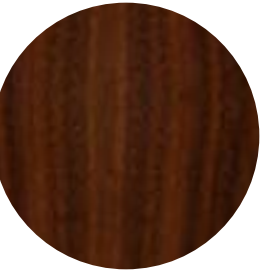

MEDIUM CHERRY
ON MAPLE
(WL03)



TONED WALNUT
(PZ20)

Welcome

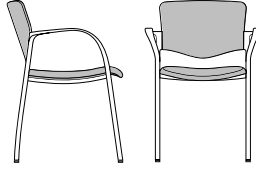
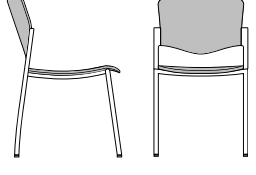
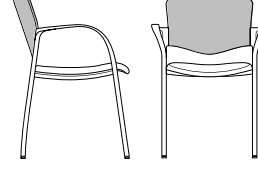
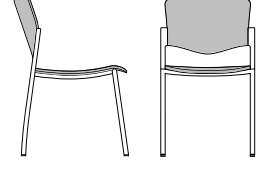
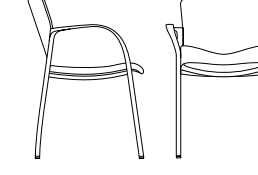
SPECIFICATION GUIDE: STATEMENT OF LINE

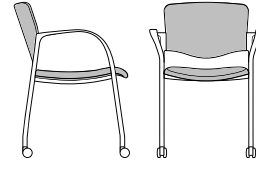
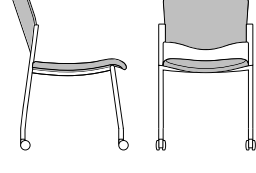
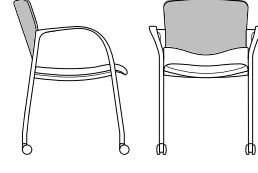
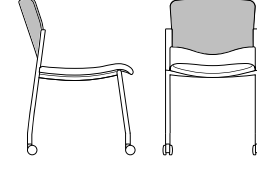
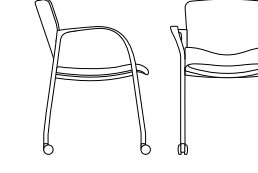
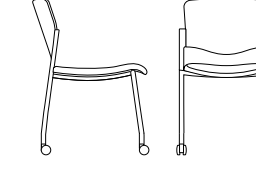
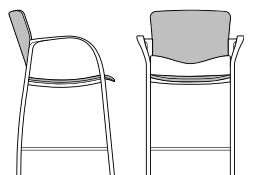
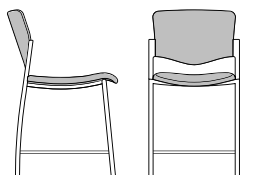
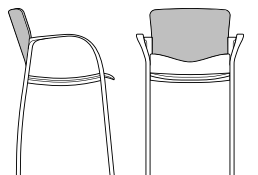
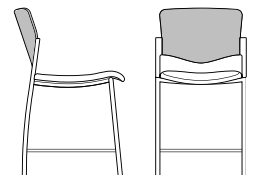
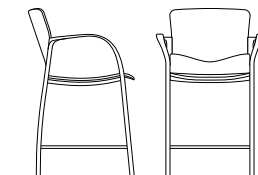
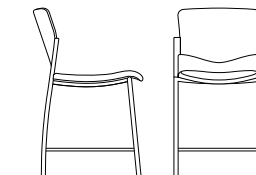
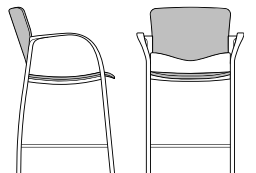
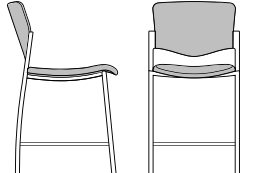
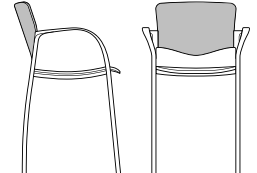
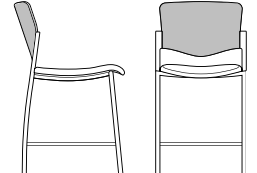
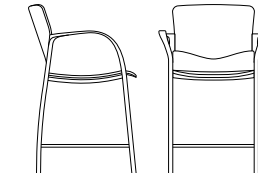
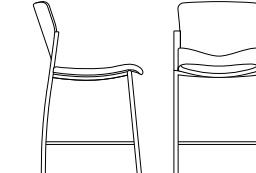
OVERVIEW	WOOD SEAT, WOOD BACK		UPHOLSTERED SEAT, WOOD BACK		UPHOLSTERED SEAT, UPHOLSTERED BACK	
Chair Four Leg Stacking	Arms 	Armless 	Arms 	Armless 	Arms 	Armless 
Chair With Casters	Arms 	Armless 	Arms 	Armless 	Arms 	Armless 
Counter Stool	Arms 	Armless 	Arms 	Armless 	Arms 	Armless 
Bar Stool	Arms 	Armless 	Arms 	Armless 	Arms 	Armless 

OPTIONS

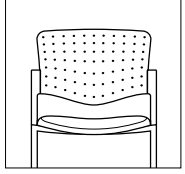
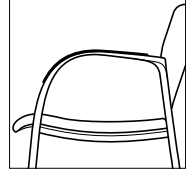
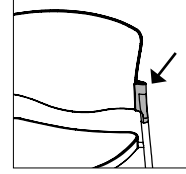
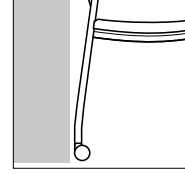
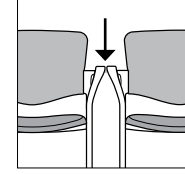
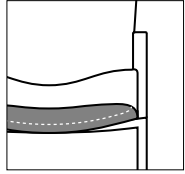
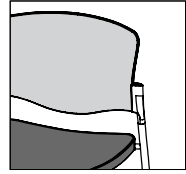
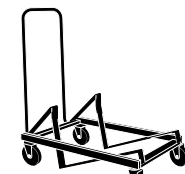
	Wood Back with 77 Holes 	Arm Caps 	Chrome Back Bracket 	Wallsaver Legs 	Ganging Bracket 
Upholstery and Accessories	Contrasting Thread 	Dual Upholstered Seat and Back 	Stacking Chair Transport Dolly 		

PRODUCT INFORMATION

Design

Sava Cvek

Construction

Seats and backs incorporate compound curve plywood. Upholstered models use polyurethane foam. Frames are steel tubing with cast aluminum arms and back brackets.

Stacking

Four leg stacking models stack six high on the floor and nine high on the Welcome transport dolly. Transport Dolly not available for caster chairs. Finish Advisory for Stacking Stylex recommends chrome frames for any stacking application requiring dollies. We will not warrant powder coated frames that have damage to the finish caused by stacking or use on the Transport Dolly. In addition, appropriate care must be exercised when stacking powder coated chairs on the floor.

Glides

Black plastic glides are standard.

Ganging Bracket Option

Arm models feature optional plated wire-formed brackets that are stackable.

Wood Finishes

The beauty of wood lies in its natural grain patterns, which are unique to each piece of wood. As such, exposed wood surfaces will not offer the same consistency as man-made materials. Some variation in color, grain, and texture are to be expected, even within the same order. Another consideration is that wood components will tend to darken over time, exaggerating slightly naturally occurring differences. Chairs ordered at different times are likely to be less similar than those ordered together. Therefore, Stylex will not guarantee a precise match of color, grain, or texture of its wood components.

Use

Designed for indoor use only.

Performance Standards

Manufactured to comply with:
ANSI/BIFMA X5.1 General-Purpose Office Chairs - Tests

Certifications

Greenguard Gold
LEVEL® 1

Welcome

SPECIFICATION GUIDE: DIMENSIONS

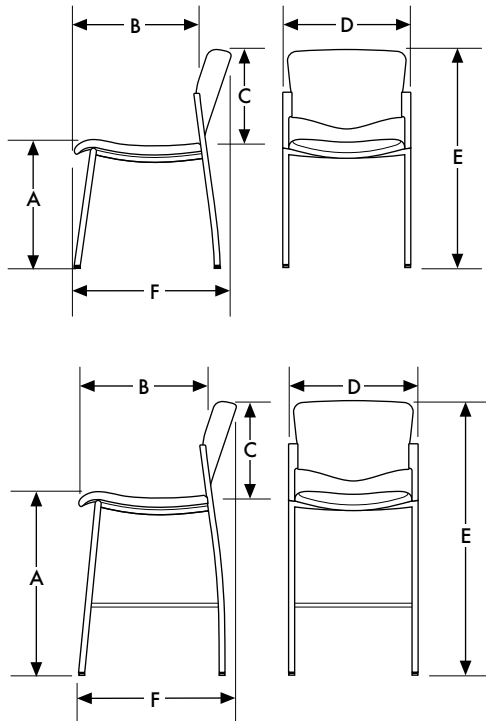
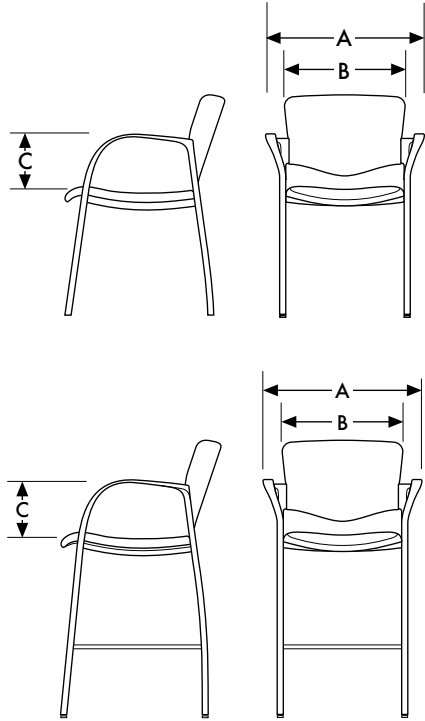
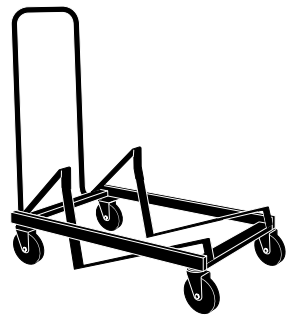
OVERVIEW	WOOD SEAT, WOOD BACK			UPHOLSTERED SEAT, WOOD BACK			UPHOLSTERED SEAT, UPHOLSTERED BACK		
<p>Dimensions</p> <ul style="list-style-type: none"> A. Seat Height B. Seat Depth C. Back Height D. Max Width E. Seat Width F. Max Height G. Max Depth 	<p>Chair</p> <ul style="list-style-type: none"> A. 17.5 B. 19 C. 15 D. 20.5 E. 17.7 F. 32 G. 22.5 	<p>Counter Stool</p> <ul style="list-style-type: none"> A. 25 B. 17.5 C. 15 D. 20 E. 17.7 F. 39 G. 23 	<p>Bar Stool</p> <ul style="list-style-type: none"> A. 29 B. 17.5 C. 15 D. 20 E. 17.7 F. 43.5 G. 23 	<p>Chair</p> <ul style="list-style-type: none"> A. 18 B. 19 C. 15 D. 20.5 E. 18 F. 32 G. 23 	<p>Counter Stool</p> <ul style="list-style-type: none"> A. 25 B. 18 C. 15 D. 20 E. 18 F. 39 G. 23 	<p>Bar Stool</p> <ul style="list-style-type: none"> A. 29.5 B. 18 C. 15 D. 24 E. 18 F. 43.5 G. 23 	<p>Chair</p> <ul style="list-style-type: none"> A. 18 B. 19 C. 15 D. 20.5 E. 18 F. 32 G. 23 	<p>Counter Stool</p> <ul style="list-style-type: none"> A. 25 B. 18 C. 15 D. 20 E. 18 F. 39 G. 23 	<p>Bar Stool</p> <ul style="list-style-type: none"> A. 29.5 B. 18 C. 15 D. 20 E. 18 F. 43.5 G. 23
<p>Arm Choice</p> <ul style="list-style-type: none"> A. Max Width B. Arm Distance C. Arm Height 	<p>Chair</p> <ul style="list-style-type: none"> A. 24 B. 21 C. 9 	<p>Counter Stool</p> <ul style="list-style-type: none"> A. 24 B. 21 C. 9 	<p>Bar Stool</p> <ul style="list-style-type: none"> A. 24 B. 21 C. 9 	<p>Chair</p> <ul style="list-style-type: none"> A. 24 B. 21 C. 8.5 	<p>Counter Stool</p> <ul style="list-style-type: none"> A. 24 B. 21 C. 8.5 	<p>Bar Stool</p> <ul style="list-style-type: none"> A. 24 B. 21 C. 8.5 	<p>Chair</p> <ul style="list-style-type: none"> A. 24 B. 21 C. 8.5 	<p>Counter Stool</p> <ul style="list-style-type: none"> A. 24 B. 21 C. 8.5 	<p>Bar Stool</p> <ul style="list-style-type: none"> A. 24 B. 21 C. 8.5
<p>Stacking</p> <ul style="list-style-type: none"> A. Width B. Depth C. Height 	<p>On Floor (6 High)</p> <ul style="list-style-type: none"> A. 20.5 B. 31 C. 46 	<p>On Dolly</p> <ul style="list-style-type: none"> A. 23.5 B. 38 C. 56 							

Welcome

SPECIFICATION GUIDE: HOW TO ORDER

MODEL CODE BREAKDOWN

Sample Model Code: **WL1317WL01BCTWSBLCOM**



WL **1** **3** **17** **WL01** **B** **CTWS** **BL** **COM**

1. Series	2. Frame	3. Seat/Back Style	4. Back Type	5. Wood Finish	6. Casters	7. Options	8. Leg Finish	9. Upholstery
<p>Series</p> <p>WL WELCOME</p>	<p>Frame</p> <p>1 CHAIR, FOUR LEG STACKING, ARMLESS</p> <p>3 CHAIR, CASTERS, ARMLESS</p> <p>2 CHAIR, FOUR LEG STACKING, ARMS</p> <p>4 CHAIR, CASTERS, ARMS</p> <p>7 STOOL, BAR HEIGHT, ARMLESS</p> <p>8 STOOL, BAR HEIGHT, ARMS</p> <p>9 STOOL, COUNTER HEIGHT, ARMLESS</p> <p>0 STOOL, COUNTER HEIGHT, ARMS</p>	<p>Seat/Back Style</p> <p>1 WOOD SEAT, WOOD BACK</p> <p>3 UPHOLSTERED SEAT, WOOD BACK</p> <p>4 UPHOLSTERED SEAT, UPHOLSTERED BACK</p>	<p>Upholstered Back Type</p> <p>10 STANDARD UPHOLSTERED BACK</p> <p>10DF DUAL UPHOLSTERED BACK</p> <p>Wood Back Type</p> <p>11 STANDARD WOOD BACK</p> <p>17 WOOD BACK WITH 77 HOLES</p>	<p>Wood Finish</p> <p>WL01 CLEAR MAPLE</p> <p>WL03 MEDIUM CHERRY ON MAPLE</p> <p>PZ20 TONED WALNUT</p>	<p>Casters</p> <p>B BLACK</p> <p>BR BLACK RUBBER TIERED CASTERS</p>	<p>Options</p> <p>CT CONTRASTING THREAD</p> <p>WS WALLSAVER LEGS</p> <p>PB CHROME BACK BRACKET</p> <p>Arm Caps</p> <p>AC10 BLACK MAGIC</p> <p>AC21 SILVERADO</p> <p>AC29 MOCHA</p> <p>AC06 WHITE</p> <p>Note: In the example above, 2 options are listed (CT and WS)</p>	<p>Standard Powder Coated Metal</p> <p>BL BLUE</p> <p>BM BLACK MATTE</p> <p>BR BRASS</p> <p>BT BLACK TWILIGHT</p> <p>CP CHAMPAGNE</p> <p>DB DARK BRONZE</p> <p>DG DARK GRAY</p> <p>DP DUSTY PINK</p> <p>FG FOREST GREEN</p> <p>LG LIGHT GRAY</p> <p>MG MEADOW GREEN</p> <p>MK MILK</p> <p>MS METALLIC SILVER</p> <p>NK NICKEL</p> <p>NV NAVY</p> <p>OR ORANGE</p> <p>PY PALE YELLOW</p> <p>RD RED</p> <p>RO RED ORANGE</p> <p>RR RUSTY RED</p> <p>SB SOFT BLUE</p> <p>SD SAND</p> <p>TC TERRACOTTA</p> <p>TP TAUPE</p> <p>TS TEXTURED SLATE</p> <p>YL YELLOW</p> <p>Chrome</p> <p>CH BRIGHT CHROME</p>	<p>Textile Grades</p> <p>COM CUSTOMER'S OWN MATERIAL</p> <p>A GRADE A</p> <p>B GRADE B</p> <p>C GRADE C</p> <p>D GRADE D</p> <p>E GRADE E</p> <p>F GRADE F</p> <p>G GRADE G</p> <p>H GRADE H</p> <p>I GRADE I</p> <p>J GRADE J</p> <p>Leather Grades</p> <p>COL CUSTOMER'S OWN LEATHER</p> <p>W GRADE W</p> <p>X GRADE X</p> <p>Y GRADE Y</p> <p>Note: Select highest grade in the case of dual upholstery</p>

Welcome

CHAIR: ARMLESS

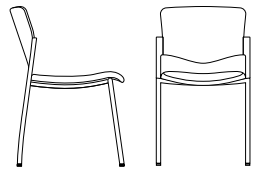
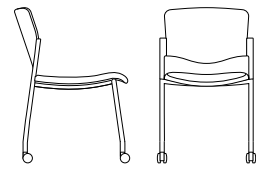
TITLE	SEAT/BACK STYLE	SERIES	FRAME	STYLE	DIMENSIONS	YDG	SQFT	WOOD	Textile Upholstery Grades								Leather Upholstery Grades				
									COM	COL	COM	COL	A	B	C	D	E	F	G	H	I
Chair, Four Leg Stacking, Armless 	Wood Seat, Wood Back	WL	1	1	20.5W x 22.5D x 32H	-	-	844	-	-	-	-	-	-	-	-	-	-	-	-	-
	Upholstered Seat, Wood Back	WL	1	3	20.5W x 23D x 32H	0.5 Seat	9 Seat	-	789	817	845	873	906	939	965	1,002	1,042	1,083	1,166	1,211	1,430
	Upholstered Seat, Upholstered Back	WL	1	4	20.5W x 23D x 32H	0.5 Seat 0.5 Back	9 Seat 9 Back	-	734	793	852	908	966	1,031	1,089	1,167	1,239	1,320	1,300	1,369	1,698
Chair, Casters, Armless 	Wood Seat, Wood Back	WL	3	1	20.5W x 22.5D x 32H	-	-	936	-	-	-	-	-	-	-	-	-	-	-	-	-
	Upholstered Seat, Wood Back	WL	3	3	20.5W x 23D x 32H	0.5 Seat	9 Seat	-	880	908	937	964	998	1,030	1,056	1,093	1,133	1,174	1,257	1,302	1,521
	Upholstered Seat, Upholstered Back	WL	3	4	20.5W x 23D x 32H	0.5 Seat 0.5 Back	9 Seat 9 Back	-	825	884	943	1,000	1,057	1,122	1,180	1,258	1,330	1,411	1,391	1,461	1,789

To Order Select Below

1. Series/Frame

WL1
Chair Four Leg Stacking Armless

WL3
Chair Casters Armless

2. Style

1 WOOD SEAT WOOD BACK

3 UPHOLSTERED SEAT WOOD BACK

4 UPHOLSTERED SEAT UPHOLSTERED BACK

3. Back Type

10 STANDARD UPHOLSTERED BACK

10DF DUAL UPHOLSTERED BACK

Wood Back Type

11 STANDARD WOOD BACK

17 WOOD BACK WITH 77 HOLES **+90**

4. Wood Finish

WL01 CLEAR MAPLE

MEDIUM CHERRY ON
WL03 MAPLE

PZ20 TONED WALNUT **+79**

Custom Color Match

09 CUSTOM COLOR **+423**

5. Casters

B BLACK

BLACK RUBBER TIED
BR CASTERS **+19**

Caster option required for Caster Frame Selection

6. Options

CT CONTRASTING THREAD

WS WALLSAVER LEGS **+18**

PB CHROME BACK BRACKET **+45**

Accessories

WLTD TRANSPORT DOLLY **+1,260**

Wallsaver legs not available on caster frames. Chrome brackets, standard on chrome frames, highlight the aluminum casting.

7. Frame Finish

Standard Powder Coated Metal

BL BLUE

BM BLACK MATTE

BR BRASS

BT BLACK TWILIGHT

CP CHAMPAGNE

DB DARK BRONZE

DG DARK GRAY

DP DUSTY PINK

FG FOREST GREEN

LG LIGHT GRAY

MG MEADOW GREEN

MK MILK

MS METALLIC SILVER

Chrome

CH BRIGHT CHROME **+106**

NK NICKEL

NV NAVY

OR ORANGE

PY PALE YELLOW

RD RED

RO RED ORANGE

RR RUSTY RED

SB SOFT BLUE

SD SAND

TC TERRACOTTA

TP TAUPE

TS TEXTURED SLATE

YL YELLOW

8. Upholstery

See general information section for details on textile program and COM/COL information.

Welcome

CHAIR: ARMS

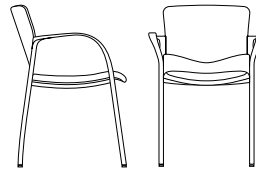
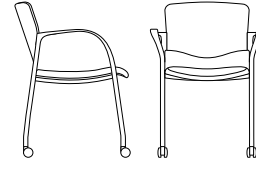
TITLE	SEAT/BACK STYLE	SERIES	FRAME	STYLE	DIMENSIONS	COM YDG	COL SQFT	WOOD	Textile Upholstery Grades										Leather Upholstery Grades		
									A	B	C	D	E	F	G	H	I	J	W	X	Y
Chair, Four Leg Stacking, Arms 	Wood Seat, Wood Back	WL	2	1	24W x 22.5D x 32H	-	-	961	-	-	-	-	-	-	-	-	-	-	-	-	-
	Upholstered Seat, Wood Back	WL	2	3	24W x 23D x 32H	0.5 Seat	9 Seat	-	902	930	961	990	1,019	1,050	1,080	1,119	1,155	1,196	1,277	1,323	1,544
	Upholstered Seat, Upholstered Back	WL	2	4	24W x 23D x 32H	0.5 Seat 0.5 Back	9 Seat 9 Back	-	851	908	965	1,027	1,084	1,143	1,209	1,280	1,351	1,436	1,416	1,483	1,810
Chair, Casters, Arms 	Wood Seat, Wood Back	WL	4	1	24W x 22.5D x 32H	-	-	1,052	-	-	-	-	-	-	-	-	-	-	-	-	-
	Upholstered Seat, Wood Back	WL	4	3	24W x 23D x 32H	0.5 Seat	9 Seat	-	993	1,022	1,052	1,082	1,110	1,141	1,172	1,211	1,246	1,287	1,368	1,414	1,635
	Upholstered Seat, Upholstered Back	WL	4	4	24W x 23D x 32H	0.5 Seat 0.5 Back	9 Seat 9 Back	-	942	1,000	1,056	1,118	1,175	1,235	1,300	1,371	1,443	1,528	1,508	1,574	1,902

To Order Select Below

<p>1. Series/Frame</p> <p>WL2 Chair Four Leg Stacking Arms</p> <p>WL4 Chair Casters Arms</p>	<p>2. Style</p> <p>1 WOOD SEAT WOOD BACK</p> <p>3 UPHOLSTERED SEAT WOOD BACK</p> <p>4 UPHOLSTERED SEAT UPHOLSTERED BACK</p>	<p>3. Back Type</p> <p>10 STANDARD UPHOLSTERED BACK</p> <p>10DF DUAL UPHOLSTERED BACK</p> <p>Wood Back Type</p> <p>11 STANDARD WOOD BACK</p> <p>17 WOOD BACK WITH 77 HOLES +90</p>	<p>4. Wood Finish</p> <p>WL01 CLEAR MAPLE</p> <p>MEDIUM CHERRY ON</p> <p>WL03 MAPLE</p> <p>PZ20 TONED WALNUT +79</p> <p>Custom Color Match</p> <p>09 CUSTOM COLOR +423</p>	<p>5. Casters</p> <p>B BLACK</p> <p>BLACK RUBBER TIED</p> <p>BR CASTERS +19</p> <p>Caster option required for Caster Frame Selection</p>	<p>6. Options</p> <p>CT CONTRASTING THREAD</p> <p>WS WALLSAVER LEGS +18</p> <p>GA GANGING BRACKET +45</p> <p>Wallsaver legs not available on caster frames.</p> <p>Arm Caps +54</p> <p>AC10 BLACK MAGIC</p> <p>AC21 SILVERADO</p> <p>AC29 MOCHA</p> <p>AC06 WHITE</p> <p>Accessories</p> <p>WLTD TRANSPORT DOLLY +1,260</p>	<p>7. Frame Finish</p> <p>Standard Powder Coated Metal</p> <p>BL BLUE</p> <p>BM BLACK MATTE</p> <p>BR BRASS</p> <p>BT BLACK TWILIGHT</p> <p>CP CHAMPAGNE</p> <p>DB DARK BRONZE</p> <p>DG DARK GRAY</p> <p>DP DUSTY PINK</p> <p>FG FOREST GREEN</p> <p>LG LIGHT GRAY</p> <p>MG MEADOW GREEN</p> <p>MK MILK</p> <p>MS METALLIC SILVER</p> <p>Chrome</p> <p>CH BRIGHT CHROME +207</p> <p>NK NICKEL</p> <p>NV NAVY</p> <p>OR ORANGE</p> <p>PY PALE YELLOW</p> <p>RD RED</p> <p>RO RED ORANGE</p> <p>RR RUSTY RED</p> <p>SB SOFT BLUE</p> <p>SD SAND</p> <p>TC TERRACOTTA</p> <p>TP TAUPE</p> <p>TS TEXTURED SLATE</p> <p>YL YELLOW</p>	<p>8. Upholstery</p> <p>See general information section for details on textile program and COM/COL information.</p>
---	--	---	--	--	---	--	--

Welcome

STOOL: ARMLESS

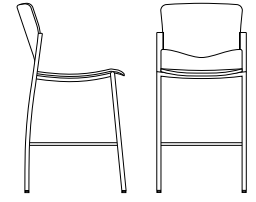
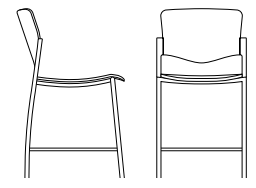
TITLE	SEAT/BACK STYLE	SERIES	FRAME	STYLE	DIMENSIONS	COM	COL	WOOD	Textile Upholstery Grades										Leather Upholstery Grades		
									A	B	C	D	E	F	G	H	I	J	W	X	Y
Stool, Bar Height, Armless 	Wood Seat, Wood Back	WL	7	1	20W x 23D x 43.5H	-	-	1,214	-	-	-	-	-	-	-	-	-	-	-	-	-
	Upholstered Seat, Wood Back	WL	7	3	20W x 23D x 43.5H	0.5 Seat	9 Seat	-	1,155	1,183	1,216	1,244	1,274	1,303	1,337	1,371	1,408	1,449	1,533	1,577	1,798
	Upholstered Seat, Upholstered Back	WL	7	4	20W x 23D x 43.5H	0.5 Seat 0.5 Back	9 Seat 9 Back	-	1,110	1,167	1,222	1,280	1,342	1,402	1,464	1,540	1,612	1,697	1,674	1,741	2,070
Stool, Counter Height, Armless 	Wood Seat, Wood Back	WL	9	1	20W x 23D x 39H	-	-	1,214	-	-	-	-	-	-	-	-	-	-	-	-	-
	Upholstered Seat, Wood Back	WL	9	3	20W x 23D x 39H	0.5 Seat	9 Seat	-	1,155	1,183	1,216	1,244	1,274	1,303	1,337	1,371	1,408	1,449	1,533	1,577	1,798
	Upholstered Seat, Upholstered Back	WL	9	4	20W x 23D x 39H	0.5 Seat 0.5 Back	9 Seat 9 Back	-	1,110	1,167	1,222	1,280	1,342	1,402	1,464	1,540	1,612	1,697	1,674	1,741	2,070

To Order Select Below

<p>1. Series/Frame</p> <p>●</p> <p>WL7</p> <p>Stool Bar Height Armless</p> <p>WL9</p> <p>Stool Counter Height Armless</p>	<p>2. Style</p> <p>● Style</p> <p>1 WOOD SEAT WOOD BACK</p> <p>3 UPHOLSTERED SEAT WOOD BACK</p> <p>4 UPHOLSTERED SEAT UPHOLSTERED BACK</p>	<p>3. Back Type</p> <p>● Upholstered Back Type</p> <p>10 STANDARD UPHOLSTERED BACK</p> <p>10DF DUAL UPHOLSTERED BACK</p> <p>● Wood Back Type</p> <p>11 STANDARD WOOD BACK</p> <p>17 WOOD BACK WITH 77 HOLES +90</p>	<p>4. Wood Finish</p> <p>● Wood Finish</p> <p>WL01 CLEAR MAPLE</p> <p>WL03 MEDIUM CHERRY ON MAPLE +79</p> <p>PZ20 TONED WALNUT</p> <p>● Custom Color Match</p> <p>09 CUSTOM COLOR +423</p>	<p>5. Options</p> <p>● Options</p> <p>CT CONTRASTING THREAD</p> <p>PB CHROME BACK BRACKET +45</p> <p>Chrome brackets, standard on chrome frames, highlight the aluminum casting.</p>	<p>6. Frame Finish</p> <p>● Standard Powder Coated Metal</p> <p>BL BLUE</p> <p>BM BLACK MATTE</p> <p>BR BRASS</p> <p>BT BLACK TWILIGHT</p> <p>CP CHAMPAGNE</p> <p>DB DARK BRONZE</p> <p>DG DARK GRAY</p> <p>DP DUSTY PINK</p> <p>FG FOREST GREEN</p> <p>LG LIGHT GRAY</p> <p>MG MEADOW GREEN</p> <p>MK MILK</p> <p>MS METALLIC SILVER</p> <p>● Chrome</p> <p>CH BRIGHT CHROME +195</p> <p>NK NICKEL</p> <p>NV NAVY</p> <p>OR ORANGE</p> <p>PY PALE YELLOW</p> <p>RD RED</p> <p>RO RED ORANGE</p> <p>RR RUSTY RED</p> <p>SB SOFT BLUE</p> <p>SD SAND</p> <p>TC TERRACOTTA</p> <p>TP TAUPE</p> <p>TS TEXTURED SLATE</p> <p>YL YELLOW</p>	<p>8. Upholstery</p> <p>● See general information section for details on textile program and COM/COL information.</p>
--	--	---	---	---	--	---

Welcome

STOOL: ARMS

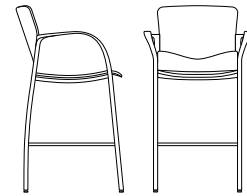
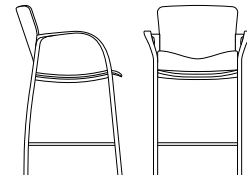
TITLE	SEAT/BACK STYLE	SERIES	FRAME	STYLE	DIMENSIONS	COM	COL	WOOD	Textile Upholstery Grades										Leather Upholstery Grades		
									A	B	C	D	E	F	G	H	I	J	W	X	Y
Stool, Bar Height, Arms 	Wood Seat, Wood Back	WL	8	1	24W x 23D x 43.5H	-	-	1,327	-	-	-	-	-	-	-	-	-	-	-	-	-
	Upholstered Seat, Wood Back	WL	8	3	24W x 23D x 43.5H	0.5 Seat	9 Seat	-	1,274	1,301	1,335	1,360	1,389	1,423	1,450	1,490	1,529	1,567	1,653	1,697	1,914
	Upholstered Seat, Upholstered Back	WL	8	4	24W x 23D x 43.5H	0.5 Seat 0.5 Back	9 Seat 9 Back	-	1,218	1,277	1,339	1,392	1,453	1,515	1,577	1,654	1,724	1,805	1,784	1,852	2,181
Stool, Counter Height, Arms 	Wood Seat, Wood Back	WL	0	1	24W x 23D x 39H	-	-	1,327	-	-	-	-	-	-	-	-	-	-	-	-	-
	Upholstered Seat, Wood Back	WL	0	3	24W x 23D x 39H	0.5 Seat	9 Seat	-	1,274	1,301	1,335	1,360	1,389	1,423	1,450	1,490	1,529	1,567	1,653	1,697	1,914
	Upholstered Seat, Upholstered Back	WL	0	4	24W x 23D x 39H	0.5 Seat 0.5 Back	9 Seat 9 Back	-	1,218	1,277	1,339	1,392	1,453	1,515	1,577	1,654	1,724	1,805	1,784	1,852	2,181

To Order Select Below

<p>1. Series/Frame</p> <p>●</p> <p>WL8</p> <hr/> <p>Stool Bar Height Arms</p> <hr/> <p>WL0</p> <hr/> <p>Stool Counter Height Arms</p>	<p>2. Style</p> <p>● Style</p> <p>1 WOOD SEAT WOOD BACK</p> <hr/> <p>3 UPHOLSTERED SEAT WOOD BACK</p> <hr/> <p>4 UPHOLSTERED SEAT UPHOLSTERED BACK</p>	<p>3. Back Type</p> <p>● Upholstered Back Type</p> <p>10 STANDARD UPHOLSTERED BACK</p> <hr/> <p>10DF DUAL UPHOLSTERED BACK</p> <hr/> <p>● Wood Back Type</p> <p>11 STANDARD WOOD BACK</p> <hr/> <p>17 WOOD BACK WITH 77 HOLES +90</p>	<p>4. Wood Finish</p> <p>● Wood Finish</p> <p>WL01 CLEAR MAPLE</p> <hr/> <p>WL03 MEDIUM CHERRY ON MAPLE +79</p> <hr/> <p>PZ20 TONED WALNUT</p> <hr/> <p>● Custom Color Match</p> <p>09 CUSTOM COLOR +423</p>	<p>5. Options</p> <p>● Options</p> <p>CT CONTRASTING THREAD</p> <hr/> <p>● Arm Caps +54</p> <p>AC10 BLACK MAGIC</p> <hr/> <p>AC21 SILVERADO</p> <hr/> <p>AC29 MOCHA</p> <hr/> <p>AC06 WHITE</p>	<p>6. Frame Finish</p> <p>● Standard Powder Coated Metal</p> <p>BL BLUE</p> <hr/> <p>BM BLACK MATTE</p> <hr/> <p>BR BRASS</p> <hr/> <p>BT BLACK TWILIGHT</p> <hr/> <p>CP CHAMPAGNE</p> <hr/> <p>DB DARK BRONZE</p> <hr/> <p>DG DARK GRAY</p> <hr/> <p>DP DUSTY PINK</p> <hr/> <p>FG FOREST GREEN</p> <hr/> <p>LG LIGHT GRAY</p> <hr/> <p>MG MEADOW GREEN</p> <hr/> <p>MK MILK</p> <hr/> <p>MS METALLIC SILVER</p> <hr/> <p>● Chrome</p> <p>CH BRIGHT CHROME +299</p>	<p>8. Upholstery</p> <p>● See general information section for details on textile program and COM/COL information.</p> <p>NK NICKEL</p> <hr/> <p>NV NAVY</p> <hr/> <p>OR ORANGE</p> <hr/> <p>PY PALE YELLOW</p> <hr/> <p>RD RED</p> <hr/> <p>RO RED ORANGE</p> <hr/> <p>RR RUSTY RED</p> <hr/> <p>SB SOFT BLUE</p> <hr/> <p>SD SAND</p> <hr/> <p>TC TERRACOTTA</p> <hr/> <p>TP TAUPE</p> <hr/> <p>TS TEXTURED SLATE</p> <hr/> <p>YL YELLOW</p>
--	--	---	---	---	--	---

stylex

Zephyr

PRICE LIST

Effective November 01, 2023

General Information

GENERAL INFORMATION

Terms

Net 30 days from date of invoice.
FOB Delanco, NJ

Damaged Shipments

All Stylex products are carefully inspected before they are packed in sturdy cartons designed to satisfy shipping requirements. Stylex is not responsible for damage in shipment. The transportation company assumes responsibility for delivering products to you in good condition when the bill of lading is signed. You protect yourself by refusing shipments showing damage or shortage until transportation company has noted on the delivery sheet the extent of damage or shortage. Concealed damage should be reported to the carrier as soon as discovered, but not later than 15 days after receiving shipment.

Return/Restocking Policy

Return shipments will not be accepted unless specifically authorized by Stylex in writing. The Return Authorization number should be clearly marked on the carton. The customer returning Stylex products is responsible for return shipping costs. Merchandise must be returned unused. Returned merchandise is subject to a 35% restocking fee.

Specials/Customs

Modifications to standard products will be considered for large runs. Contact Stylex for more information.

Design Changes

In keeping with modern manufacturing advances, Stylex reserves the right to incorporate minor modifications and design changes in products without notice.

Cancellation Policy

No charge prior to production except for inventory specifically requisitioned to fulfill the particular order. After production has begun, only actual costs incurred, including labor and material, will be billed to the customer.

WARRANTY

Except as provided below, Stylex warrants exclusively to the original Purchaser of our product that all parts, under normal use and service, will be free from defects in workmanship and material for a period of ten (10) years from the date of purchase. "Normal use and service" means that the product will be used in a typical office environment for 40-45 hours per week.

This warranty is subject to the following limitations, exclusions and provisions:

Wood components of plywood stacking chairs
(such as Brooks and Welcome)
5 years

Upholstery
(including mesh used for Click, F4, Insight, and Zephyr Mesh)
3 years

SAVA Mesh
10 years

COM Upholstery
No warranty
Stylex makes every effort to ensure that the COM Upholstery it approves is suitable for the intended use. Nevertheless, we will not warrant, and assume no responsibility for, the durability or tailoring quality of any COM or COL. If you have any concerns about the ultimate appearance of any covering, please order an upholstered sample.

Painted Stack Chair Frames
No Warranty
We will not warrant the finish of painted stack chair frames against damage from stacking. We recommend ordering chrome frames for chairs that will be stacked.

Felt Glides
No warranty
Due to the different surfaces on which felt glides may be used, we cannot warrant their durability over time.

If this product fails during normal use and service within the applicable warranty period (other than through normal wear and tear), please send a description of the relevant part and the nature of the defect, together with proof of purchase of the product, to Stylex at: Customer Service. c/o Stylex, P.O. Box 5038, Delanco, NJ 08075. PLEASE DO NOT RETURN PARTS OR THE PRODUCT TO STYLEX UNLESS INSTRUCTED TO DO SO BY STYLEX. Stylex will, at its option, either repair or replace the product or the part found defective by Stylex completely without charge for materials or labor. Purchaser may be required (at the option of Stylex) to return to Stylex at Purchaser's expense any defective part with all freight or shipping charges prepaid. The foregoing warranty shall be void if the product has been altered or repaired (other than by Stylex). The warranty does not cover damage to the product caused by accident, neglect, misuse, abuse, modification to the product by anyone other than Stylex or damage caused by use of the product for a purpose other than that for which it was designed. This warranty extends only to the original Purchaser of the product.

No Other Warranties

This warranty is in lieu of all other warranties, expressed or implied, including, but not limited to, implied warranties of merchantability and fitness for a particular purpose. The rights and remedies provided herein are the exclusive rights and remedies of the original purchaser of the product.

No Liability For Damages

In no event shall Stylex or its suppliers be responsible or liable for any special, indirect, consequential, or incidental damages. In no event shall the liability of Stylex exceed the actual purchase price paid to Stylex for the product.

Out of Warranty Products

For all products no longer covered by our warranty, please refer to our Design for Durability and Upgradability Policy. Contact Customer Service if you would like to purchase any replaceable components to further extend the life of any Stylex seating product. This warranty applies to all Stylex products purchased on April 13, 2018, and thereafter.

PRODUCT TAKE BACK PROGRAM

At Stylex, responsible stewardship of our products extends beyond their initial use. Our Product Take Back Program provides a practical solution for the end of our products' intended life cycle.

Through our partnership with ANEW, a 501(c)(3) nonprofit organization, we offer clients a comprehensive take-back solution for surplus office furniture and materials, regardless of their condition. ANEW's mission aligns with ours—to connect surplus resources with non-profits, public agencies, and underserved communities, minimizing landfill impact and maximizing corporate social responsibility.

By repurposing surplus items, we strengthen community networks and reduce environmental impact. Stylex proudly supports ANEW, integrating this partnership into our strategic sales strategy since 2014. Learn more at www.anewfound.org.

Initiate a Product Take Back through ANEW by emailing Stylex at info@stylexdesign.com. For additional end-of-life recovery options, refer to our Product Disassembly Instructions and End of Life Recovery Options documents, available in the Resources section of each product on our website. Together, let's build a sustainable future.

FREIGHT PROGRAM

Stylex offers a Guaranteed Freight Program, which provides the purchaser the ability to determine shipping and handling charges at the time of order. Freight charges will be calculated as a percentage of the net product price and added to the invoice at the time of shipment. The continental United States has been divided into three zones. Please use the map below to determine the freight charges for the product's destination. There is a minimum freight charge of \$150.

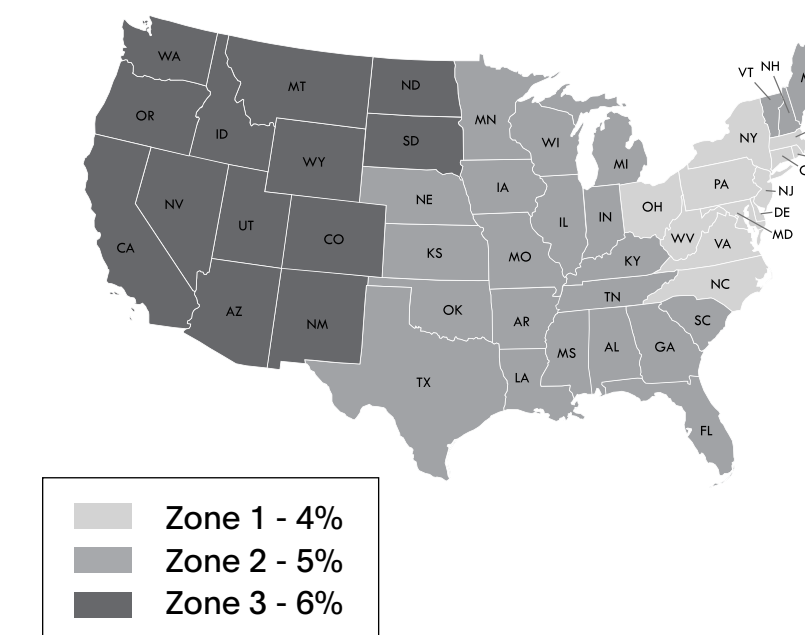

ZONE 1 - 4%

Connecticut
Delaware
New York
New Jersey
Maryland
Massachusetts
North Carolina
Ohio
Pennsylvania
Rhode Island
Virginia
Washington D.C.
West Virginia

ZONE 2 - 5%

Alabama
Arkansas
Canada, Ontario
Canada, Quebec
Florida
Georgia
Iowa
Illinois
Indiana
Kansas
Kentucky
Louisiana
Nebraska
New Hampshire
Oklahoma
Maine
Michigan
Minnesota
Missouri
Mississippi
South Carolina
Tennessee
Texas
Vermont
Wisconsin

ZONE 3 - 6%

Arizona
California
Colorado
Idaho
Montana
Nevada
New Mexico
North Dakota
Oregon
South Dakota
Utah
Washington
Wyoming

Quote Per Project

Alaska
Hawaii
Canada
(outside Ontario & Quebec)
Mexico

General Information

TEXTILE PARTNERS & APPROVALS

Textile Partners

To customize your furniture performance needs and design vision, Stylex offers a wide selection of in-graded leathers and textiles from Grades A through Y. We've partnered with leading manufacturers on the options, focusing on color, price, durability, and construction. To view our partners and explore our digital carded program with broadly approved textiles, visit [this page](#). We stand by these textiles: They're tried and tested, and will effortlessly fit into any design aesthetic.

Textile Approvals

To view Stylex Approved Textile documents to determine specific product approval status, refer to our Product Tested Textiles documents, available in the Resources section of each product on our website.

CAL 117 AND 133 COMPLIANCE

CAL 117-2013

All Stylex seating satisfies the requirements of CAL 117-2013 so long as one of our standard or in-graded textiles is applied. COM textiles cannot be so guaranteed. Please contact the supplier of COM's directly to determine the fire retardancy of any COM supplied to us.

CAL 133

Most Stylex seating can be ordered to meet the requirements of CAL 133. When ordering, simply specify "CAL 133 compliance required". The upcharge for this option is \$54 list per yard. Please refer to the COM yardage of each model to determine the number of yards required. We do frequently require full-scale burn tests in order to certify CAL 133 before an order will be accepted. Such burn tests may increase normal lead times and do carry additional charges. Please contact customer service for details.

CUSTOMER'S OWN MATERIAL/LEATHER

Customer's own material (COM) and customer's own leather (COL) will generally be upholstered at the price designated in each product's price list. Please be advised, however, that we specifically reserve the right to charge a higher price when we determine that special circumstances, such as unusual repeats or challenging materials, present themselves. All orders for custom coverings must be approved by Stylex before they will be accepted for production. To submit proposed textile for approval, please use the COM form [here](#).

Special Note:

We assume no responsibility for the durability or tailoring quality of any COM or COL. Directional covers in particular may not meet your satisfaction due to the design of certain products. Please be advised that COM and COL orders are not subject to return. If you have doubts about the ultimate appearance of certain coverings, please order a sample done with that specific COM or COL. In addition, while we inspect textiles for mill imperfections, some are difficult to recognize. We cannot be responsible for defects, color inaccuracies, dye lot variations, or other flaws.

Under no circumstances will we be responsible for COM shortages, flaws, or other such problems. Finally, it is not our responsibility to police the receipt of COM's in order to meet delivery deadlines, and we assume our customers are aware of any undue delay in the shipment of their COM textiles.

COM textile and COL leather should be sent prepaid to: Stylex

**Attn: COM/COL - [Your PO #]
740 Coopertown Road
Delanco, NJ 08075**

Clearly mark textile or leather with the dealer's name, purchase order number, and furniture model number of the item to be covered. Actual furniture orders should include the same information, as well as a description of the textile or leather, including pattern and color number, in order to provide a cross reference.

Yardage requirements shown in the price list are based on non-directional goods of 54" width. Textiles less than 54" wide or those requiring matching (stripes, prints, or large patterned designs) call for additional yardage. We will be happy to supply yardage requirements for large quantities where economies may be realized.

Add the following yardage for stripes, plaids, or patterns with repeats:

Textile Width	Plain Textile	2-14" Repeat	15-24" Repeat	25-27" Repeat	28-36" Repeat
54"	0%	10%	15%	20%	25%
50"	10%	20%	25%	30%	35%
48"	15%	25%	30%	35%	40%
45"	40%	50%	55%	60%	65%
36"	50%	60%	65%	70%	75%

COM/COL FORM

To avoid delay in processing COM orders we request that you submit a sample of your COM textile stapled to this form which can be downloaded [here](#). If a textile has a stripe or design, the size of the repeat should be indicated. Please indicate the textile supplier's name, textile number, and color. Also indicate the Stylex product on which the textile will be used.

The textile supplier must indicate on his shipping labels the dealer name and purchase order number as well as the Stylex model number.

Please Note:

No order may be entered into production or have a shipping date assigned until all related COM is received at the factory.



CENTER OF STRIPE OR DESIGN

TOP	TOP
-----	-----

1. Size of Repeat

2. Textile Supplier

3. Textile Number

4. Color

5. Stylex Product

Contents

<hr/>		<hr/>	
COLORS, MATERIALS, AND FINISHES	5	STACKING CHAIR: ARM & ARMLESS	9
STATEMENT OF LINE	6	STOOL: COUNTER	10
DIMENSIONS	7	STOOL: BAR	11
HOW TO ORDER	8		
<hr/>		<hr/>	

CLICK THE TITLES ABOVE TO NAVIGATE THROUGH THE DOCUMENT
PRODUCT HEADERS ON SUBSEQUENT PAGES LINK BACK TO THIS PAGE

Zephyr

COLORS, MATERIALS, AND FINISHES

POWDER COAT FINISH

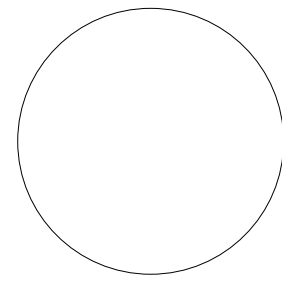

MILK
(MK)

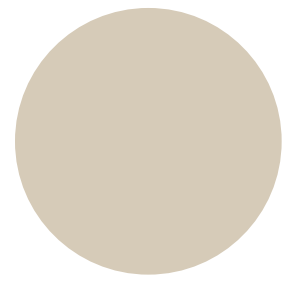

SAND
(SD)

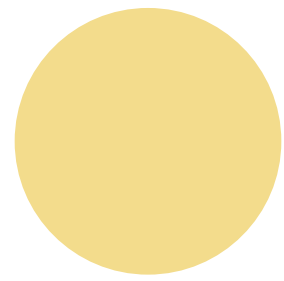

PALE YELLOW
(PY)

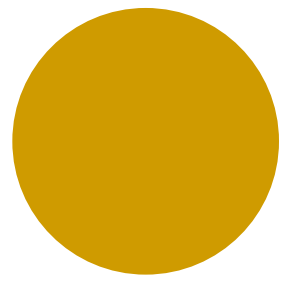

YELLOW
(YL)

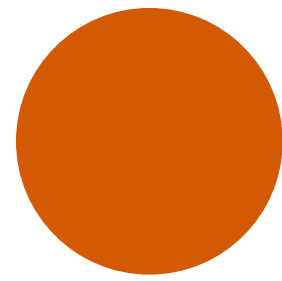

ORANGE
(OR)

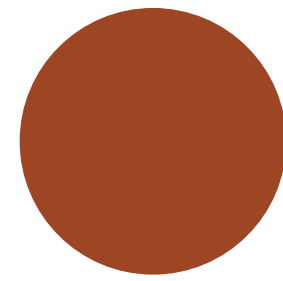

TERRACOTTA
(TC)

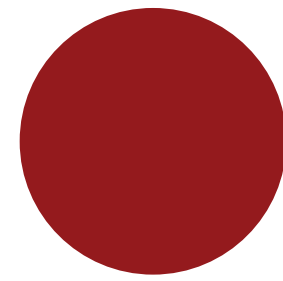

RED
(RD)

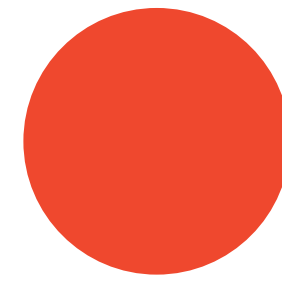

RED ORANGE
(RO)

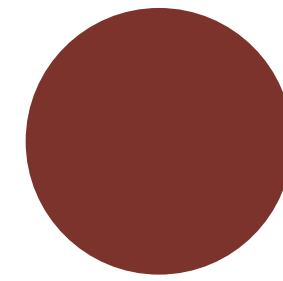

RUSTY RED
(RR)

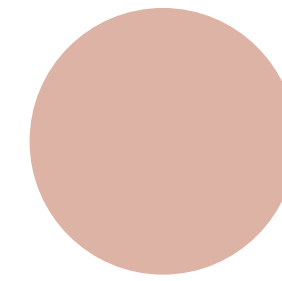

DUSTY PINK
(DP)

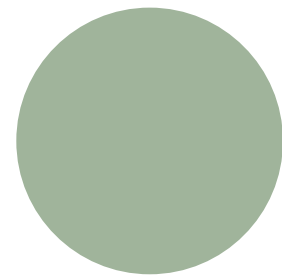

MEADOW GREEN
(MG)

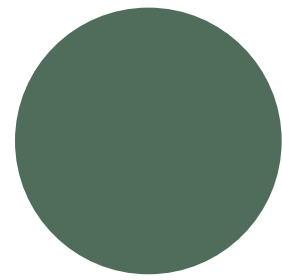

FOREST GREEN
(FG)

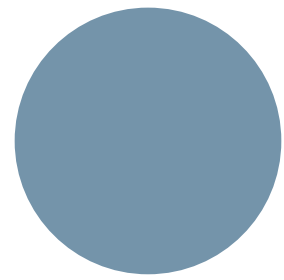

SOFT BLUE
(SB)

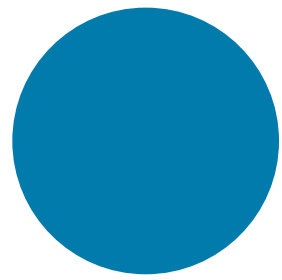

BLUE
(BL)

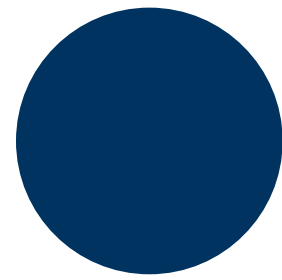

NAVY
(NV)

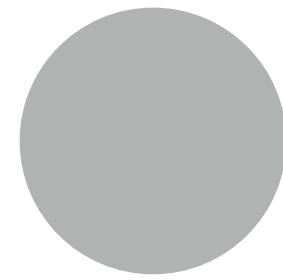

LIGHT GRAY
(LG)

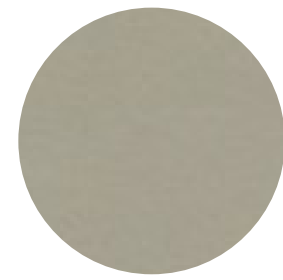

CHAMPAGNE
(CP)

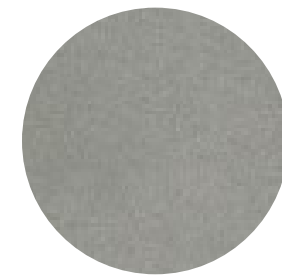

METALLIC SILVER
(MS)

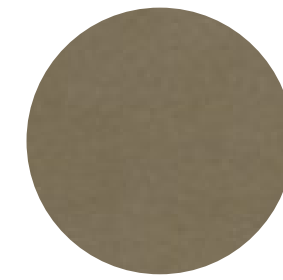

NICKEL
(NK)

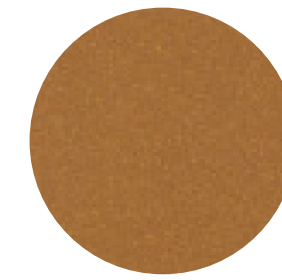

BRASS
(BR)

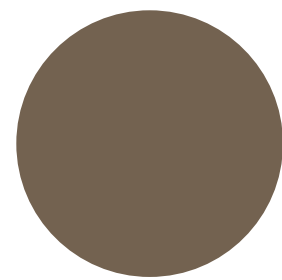

TAUPE
(TP)



DARK BRONZE
(DB)

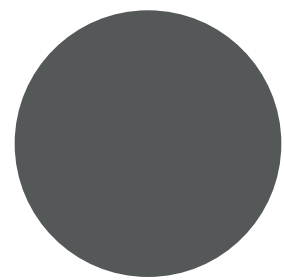

DARK GRAY
(DG)



TEXTURED SLATE
(TS)

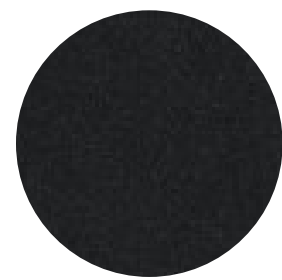

BLACK TWILIGHT
(BT)

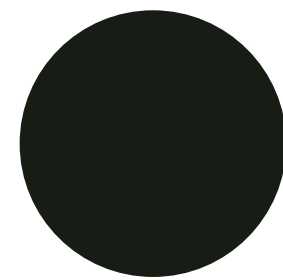

BLACK MATTE
(BM)

POLISHED METAL LEG FINISH

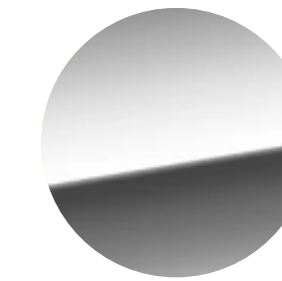

CHROME
(CH)

MESH FINISH

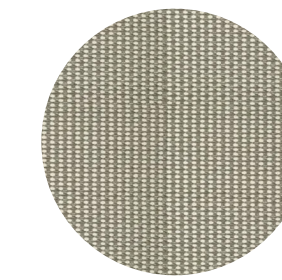

PLATINUM MESH
(102)

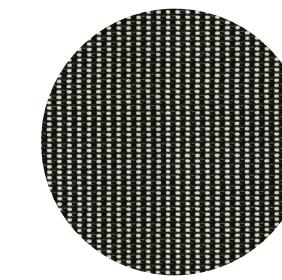

BLACK MESH
(101)

Zephyr

SPECIFICATION GUIDE: STATEMENT OF LINE

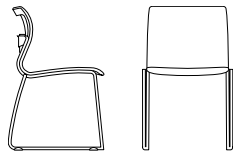
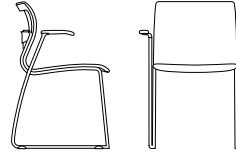
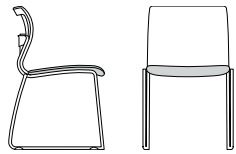
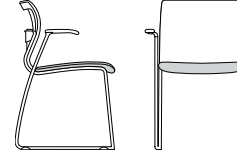
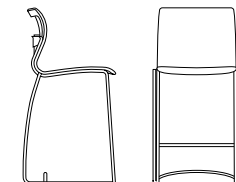
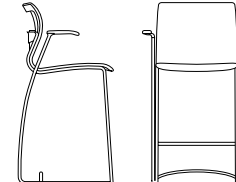
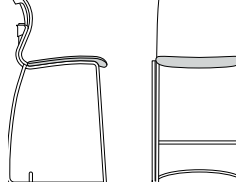
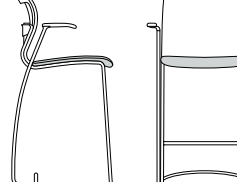
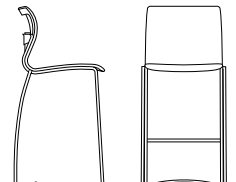
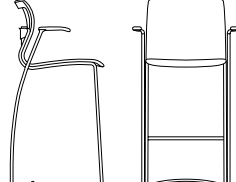
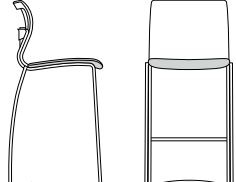
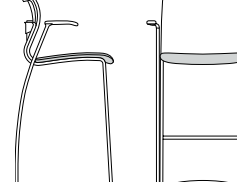
OVERVIEW	MESH SEAT, MESH BACK		UPHOLSTERED SEAT, MESH BACK	
Chair	Armless 	Arm 	Armless 	Arm 
Counter Stool	Armless 	Arm 	Armless 	Arm 
Bar Stool	Armless 	Arm 	Armless 	Arm 

ACCESSORIES

Transport Dolly

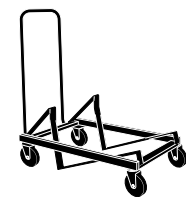

PRODUCT INFORMATION

Design

Sava Cvek

Construction

The seat and back frames which directly support the tensioned mesh are injection-molded, glass-filled nylon. Application of the mesh to the frames is achieved through a patented process to enhance both comfort and performance. Support frames are a combination of metal tube and cast aluminum.

Lumbar Cushion

Lumbar cushions are soft self-skinned polyurethane foam.

Arms

Arms are injection-molded polycarbonate.

Upholstered Seats

Seat pan is recycled polyurethane. Seat cushion is molded foam.

Glides

Glides are either plastic or plastic with felt pads.

Performance Standards

Manufactured to comply with:
ANSI/BIFMA X5.1 General-Purpose Office Chairs - Tests

Certifications

Greenguard Gold
LEVEL® 1

Zephyr

SPECIFICATION GUIDE: DIMENSIONS

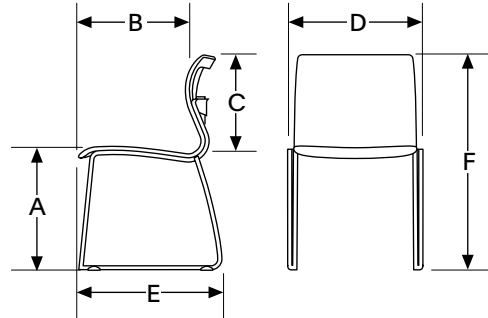
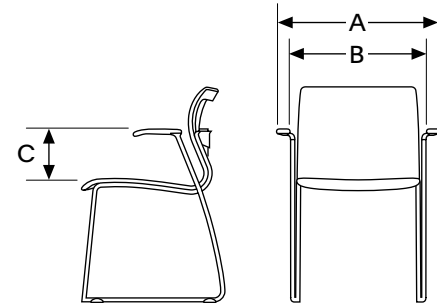
OVERVIEW	CHAIR		COUNTER STOOL		BAR STOOL			
Dimensions A. Seat Height B. Seat Depth C. Back Height D1. Seat Width D2. Overall Width E. Overall Depth F. Overall Height			Mesh Seat, Mesh Back A. 17.75 B. 18.5 C. 15 D1. 18 D2. 20.87 E. 22 F. 31	Upholstered Seat, Mesh Back A. 17.75 B. 18.5 C. 15 D1. 18 D2. 20.87 E. 22 F. 31	Mesh Seat, Mesh Back A. 25.25 B. 18.5 C. 15 D1. 18 D2. 21.25 E. 22 F. 38.5	Upholstered Seat, Mesh Back A. 25.25 B. 18.5 C. 15 D1. 18 D2. 21.25 E. 22 F. 38.5	Mesh Seat, Mesh Back A. 29.75 B. 17.5 C. 15 D1. 18 D2. 23.5 E. 19 F. 43	Upholstered Seat, Mesh Back A. 29.75 B. 17.5 C. 15 D1. 18 D2. 23.5 E. 19 F. 43
Arm Choice A. Overall Width B. Arm Distance C. Arm Height			A. 23.5 B. 19 C. 8	A. 23.5 B. 19 C. 8	A. 23.5 B. 19 C. 8	A. 23.5 B. 19 C. 8	A. 23.5 B. 19 C. 8	A. 23.5 B. 19 C. 8
Max Stacking on Floor	Armless on Floor 6 High 21W x 31.75D x 40.5H		Armless on Floor 6 high 21W x 31.75D x 46H					
	Arm on Floor 6 High 23.5W x 31.75D x 40.5H		Arm on Floor 6 high 23.5W x 31.75D x 46H					
Max Stacking on Dolly	Arm & Armless on Dolly 18 High 27.5W x 44D x 70H		Arm & Armless on Dolly 9 high 27.5W x 44D x 61.75H					

Zephyr

SPECIFICATION GUIDE: HOW TO ORDER

MODEL CODE BREAKDOWN

Sample Model Code: Z53FGGBM101COM

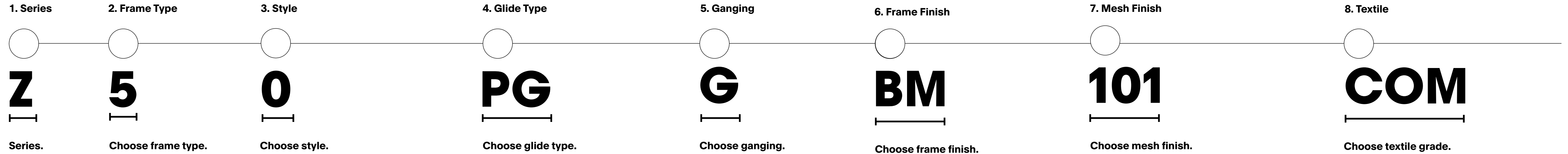

Series
Z - ZEPHYR

Frame Type
5 - ARMLESS CHAIR
6 - ARM CHAIR
7 - ARMLESS BAR
8 - ARM BAR
9 - ARMLESS COUNTER
0 - ARM COUNTER

Style
0 - MESH SEAT / MESH BACK
3 - UPHOLSTERED SEAT / MESH BACK

Glide Choice
PG - PLASTIC GLIDES
FG - PLASTIC GLIDES WITH FELT PADS

Ganging Option
G - ARMLESS GANGING

Frame Color
Standard Powder Coat
BL - BLUE
BM - BLACK MATTE
BR - BRASS
BT - BLACK TWILIGHT
CP - CHAMPAGNE
DB - DARK BRONZE
DG - DARK GRAY
DP - DUSTY PINK
FG - FOREST GREEN
LG - LIGHT GRAY
MG - MEADOW GREEN
MK - MILK
MS - METALLIC SILVER
NK - NICKEL
NV - NAVY
OR - ORANGE
PY - PALE YELLOW
RD - RED
RO - RED ORANGE
RR - RUSTY RED
SB - SOFT BLUE
SD - SAND
TC - TERRACOTTA
TP - TAUPE
TS - TEXTURED SLATE
YL - YELLOW

Other
CH - CHROME

Mesh Finish
101 - BLACK MESH ON
BLACK NYLON UPHOLSTERY FRAMES
102 - PLATINUM MESH
ON GRAY/BEIGE UPHOLSTERY FRAMES

Textile
Textile Grades
COM - CUSTOMER'S OWN MATERIAL
A - GRADE A
B - GRADE B
C - GRADE C
D - GRADE D
E - GRADE E
F - GRADE F
G - GRADE G
H - GRADE H
I - GRADE I
J - GRADE J
K - GRADE K
L - GRADE L
M - GRADE M

Leather Grades
COL - CUSTOMER'S OWN LEATHER
W - GRADE W
X - GRADE X
Y - GRADE Y
E1 - GRADE E1
E2 - GRADE E2

Zephyr

STACKING CHAIR: ARM & ARMLESS

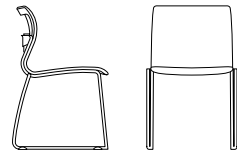
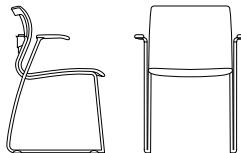
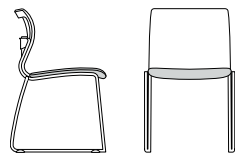
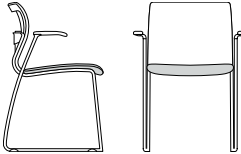
TITLE	SERIES	FRAME	STYLE	DIMENSIONS	YDG	COL	Textile Upholstery Grades													Leather Upholstery Grades					
							COM		COL											W	X	Y	E1	E2	
							A	B	C	D	E	F	G	H	I	J	K	L	M						
Chair, Mesh Seat and Mesh Back, Armless 	Z	5	0	20.9W x 22D x 31H	0.72	7	927																		
Chair, Mesh Seat and Mesh Back, Arm 	Z	6	0	23.5W x 22D x 31H	0.72	7	996																		
Chair, Upholstered Seat and Mesh Back, Armless 	Z	5	3	20.9W x 22D x 31H	0.72	7	818	840	867	891	912	941	967	996	1,030	1,066	1,116	1,159	1,201	1,003	1,029	1,138	1,196	1,283	
Chair, Upholstered Seat and Mesh Back, Arm 	Z	6	3	23.5W x 22D x 31H	0.72	7	889	911	939	962	987	1,015	1,038	1,071	1,103	1,138	1,190	1,233	1,275	1,075	1,101	1,210	1,268	1,355	

To Order Select Below

<p>1. Series</p> <p>○ Series</p> <p>Z ZEPHYR</p> <p>Stacking on Floor: 6 high</p> <p>Stacking on Dolly: 18 high - Mesh Seat 9 high - Uph. Seat</p>	<p>2. Frame</p> <p>○ Frame</p> <p>5 ARMLESS CHAIR 6 ARM CHAIR</p>	<p>3. Style</p> <p>○ Style</p> <p>0 MESH SEAT/ MESH BACK 3 UPHOLSTERED SEAT/ MESH BACK</p>	<p>4. Glide</p> <p>○ Glide</p> <p>PG PLASTIC GLIDES FG PLASTIC GLIDES WITH FELT PADS</p>	<p>5. Options</p> <p>○ Ganging</p> <p>ARMLESS GANGING +25</p> <p>● Accessories</p> <p>ZEPHYR TRANSPORT ZTD DOLLY +1916</p> 	<p>6. Frame Finish</p> <p>○ Powder Coat</p> <table border="0"> <tr> <td>BL BLUE</td> <td>LG LIGHT GRAY</td> <td>RO RED ORANGE</td> </tr> <tr> <td>BM BLACK MATTE</td> <td>MG MEADOW GREEN</td> <td>RR RUSTY RED</td> </tr> <tr> <td>BR BRASS</td> <td>MK MILK</td> <td>SB SOFT BLUE</td> </tr> <tr> <td>BT BLACK TWILIGHT</td> <td>MS METALLIC SILVER</td> <td>SD SAND</td> </tr> <tr> <td>CP CHAMPAGNE</td> <td>NK NICKEL</td> <td>TC TERRACOTTA</td> </tr> <tr> <td>DB DARK BRONZE</td> <td>NV NAVY</td> <td>TP TAUPE</td> </tr> <tr> <td>DG DARK GRAY</td> <td>OR ORANGE</td> <td>TS TEXTURED SLATE</td> </tr> <tr> <td>DP DUSTY PINK</td> <td>PY PALE YELLOW</td> <td>YL YELLOW</td> </tr> <tr> <td>FG FOREST GREEN</td> <td>RD RED</td> <td></td> </tr> </table> <p>● Other</p> <table border="0"> <tr> <td>9 CH</td> <td>CHROME ARMLESS</td> <td>+100</td> </tr> <tr> <td>CH</td> <td>CHROME ARM</td> <td>+104</td> </tr> </table> <p>Stylex will not warrant painted frames against damage caused by stacking. Only use dollies with chrome frames. We will not warrant powder coated Zephyr frames used on dollies against damage to the finish.</p>	BL BLUE	LG LIGHT GRAY	RO RED ORANGE	BM BLACK MATTE	MG MEADOW GREEN	RR RUSTY RED	BR BRASS	MK MILK	SB SOFT BLUE	BT BLACK TWILIGHT	MS METALLIC SILVER	SD SAND	CP CHAMPAGNE	NK NICKEL	TC TERRACOTTA	DB DARK BRONZE	NV NAVY	TP TAUPE	DG DARK GRAY	OR ORANGE	TS TEXTURED SLATE	DP DUSTY PINK	PY PALE YELLOW	YL YELLOW	FG FOREST GREEN	RD RED		9 CH	CHROME ARMLESS	+100	CH	CHROME ARM	+104	<p>7. Mesh</p> <p>○ Mesh</p> <p>101 BLACK MESH ON BLACK NYLON UPHOLSTERY FRAMES 102 PLATINUM MESH ON GRAY/BEIGE NYLON UPHOLSTERY FRAMES</p>	<p>8. Upholstery</p> <p>○ See general information section for details on textile program and COM/COL information.</p>
BL BLUE	LG LIGHT GRAY	RO RED ORANGE																																						
BM BLACK MATTE	MG MEADOW GREEN	RR RUSTY RED																																						
BR BRASS	MK MILK	SB SOFT BLUE																																						
BT BLACK TWILIGHT	MS METALLIC SILVER	SD SAND																																						
CP CHAMPAGNE	NK NICKEL	TC TERRACOTTA																																						
DB DARK BRONZE	NV NAVY	TP TAUPE																																						
DG DARK GRAY	OR ORANGE	TS TEXTURED SLATE																																						
DP DUSTY PINK	PY PALE YELLOW	YL YELLOW																																						
FG FOREST GREEN	RD RED																																							
9 CH	CHROME ARMLESS	+100																																						
CH	CHROME ARM	+104																																						

Zephyr

COUNTER STOOL: ARM & ARMLESS

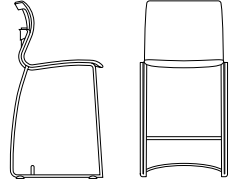
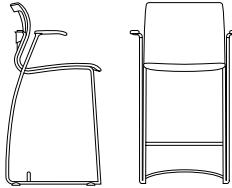
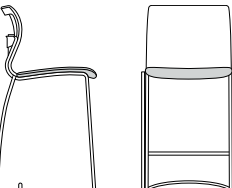
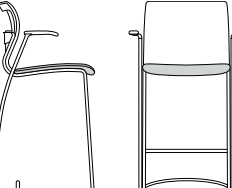
TITLE	SERIES	FRAME	STYLE	DIMENSIONS	YDG	COL	Textile Upholstery Grades													Leather Upholstery Grades					
							COM			COL										W	X	Y	E1	E2	
							A	B	C	D	E	F	G	H	I	J	K	L	M						
Counter Stool, Mesh Seat and Mesh Back, Armless 	Z	9	0	21.25W x 19D x 38.5H	0.72	7	1,258																		
Counter Stool, Mesh Seat and Mesh Back, Arm 	Z	0	0	23.5W x 19D x 38.5H	0.72	7	1,310																		
Counter Stool, Upholstered Seat and Mesh Back, Armless 	Z	9	3	21.25W x 19D x 38.5H	0.72	7	1,147	1,174	1,199	1,221	1,248	1,275	1,300	1,331	1,363	1,395	1,449	1,492	1,533	1,336	1,362	1,469	1,526	1,612	
Counter Stool, Upholstered Seat and Mesh Back, Arm 	Z	0	3	23.5W x 19D x 38.5H	0.72	7	1,200	1,224	1,251	1,275	1,300	1,327	1,351	1,385	1,415	1,449	1,502	1,545	1,587	1,388	1,414	1,521	1,578	1,664	

To Order Select Below

<p>1. Series</p> <p>○</p> <p>● Series</p> <hr/> <p>Z ZEPHYR</p>	<p>2. Frame</p> <p>○</p> <p>● Frame</p> <hr/> <p>9 ARMLESS COUNTER</p> <hr/> <p>0 ARM COUNTER</p>	<p>3. Style</p> <p>○</p> <p>● Style</p> <hr/> <p>0 MESH SEAT/ MESH BACK</p> <hr/> <p>3 UPHOLSTERED SEAT/ MESH BACK</p>	<p>4. Glide</p> <p>○</p> <p>● Glide</p> <hr/> <p>PG PLASTIC GLIDES</p> <hr/> <p>FG PLASTIC GLIDES WITH FELT PADS</p>	<p>5. Frame Finish</p> <p>○</p> <p>● Powder Coat</p> <hr/> <table border="0"> <tr> <td>BL BLUE</td> <td>LG LIGHT GRAY</td> <td>RO RED ORANGE</td> </tr> <tr> <td>BM BLACK MATTE</td> <td>MG MEADOW GREEN</td> <td>RR RUSTY RED</td> </tr> <tr> <td>BR BRASS</td> <td>MK MILK</td> <td>SB SOFT BLUE</td> </tr> <tr> <td>BT BLACK TWILIGHT</td> <td>MS METALLIC SILVER</td> <td>SD SAND</td> </tr> <tr> <td>CP CHAMPAGNE</td> <td>NK NICKEL</td> <td>TC TERRACOTTA</td> </tr> <tr> <td>DB DARK BRONZE</td> <td>NV NAVY</td> <td>TP TAUPE</td> </tr> <tr> <td>DG DARK GRAY</td> <td>OR ORANGE</td> <td>TS TEXTURED SLATE</td> </tr> <tr> <td>DP DUSTY PINK</td> <td>PY PALE YELLOW</td> <td>YL YELLOW</td> </tr> <tr> <td>FG FOREST GREEN</td> <td>RD RED</td> <td></td> </tr> </table> <hr/> <p>● Other</p> <hr/> <p>CH CHROME ARMLESS +287</p> <hr/> <p>CH CHROME ARM +315</p>	BL BLUE	LG LIGHT GRAY	RO RED ORANGE	BM BLACK MATTE	MG MEADOW GREEN	RR RUSTY RED	BR BRASS	MK MILK	SB SOFT BLUE	BT BLACK TWILIGHT	MS METALLIC SILVER	SD SAND	CP CHAMPAGNE	NK NICKEL	TC TERRACOTTA	DB DARK BRONZE	NV NAVY	TP TAUPE	DG DARK GRAY	OR ORANGE	TS TEXTURED SLATE	DP DUSTY PINK	PY PALE YELLOW	YL YELLOW	FG FOREST GREEN	RD RED		<p>6. Mesh</p> <p>○</p> <p>● Mesh</p> <hr/> <p>101 BLACK MESH ON BLACK NYLON UPHOLSTERY FRAMES</p> <hr/> <p>102 PLATINUM MESH ON GRAY/BEIGE NYLON UPHOLSTERY FRAMES</p>	<p>7. Upholstery</p> <p>○</p> <p>● See general information section for details on textile program and COM/COL information.</p>
BL BLUE	LG LIGHT GRAY	RO RED ORANGE																															
BM BLACK MATTE	MG MEADOW GREEN	RR RUSTY RED																															
BR BRASS	MK MILK	SB SOFT BLUE																															
BT BLACK TWILIGHT	MS METALLIC SILVER	SD SAND																															
CP CHAMPAGNE	NK NICKEL	TC TERRACOTTA																															
DB DARK BRONZE	NV NAVY	TP TAUPE																															
DG DARK GRAY	OR ORANGE	TS TEXTURED SLATE																															
DP DUSTY PINK	PY PALE YELLOW	YL YELLOW																															
FG FOREST GREEN	RD RED																																

Zephyr

BAR STOOL: ARM & ARMLESS

TITLE	SERIES	FRAME	STYLE	DIMENSIONS	YDG	COL	Textile Upholstery Grades													Leather Upholstery Grades					
							COM		COL											W	X	Y	E1	E2	
							A	B	C	D	E	F	G	H	I	J	K	L	M						
Bar Stool, Mesh Seat and Mesh Back, Armless	Z	7	0	21.25W x 19D x 43H	0.72	7	1,258																		
Bar Stool, Mesh Seat and Mesh Back, Arm	Z	8	0	23.5W x 19D x 43H	0.72	7	1,310																		
Bar Stool, Upholstered Seat and Mesh Back, Armless	Z	7	3	21.25W x 19D x 43H	0.72	7	1,147	1,174	1,199	1,221	1,248	1,275	1,300	1,331	1,363	1,395	1,449	1,492	1,533	1,336	1,362	1,469	1,526	1,612	
Bar Stool, Upholstered Seat and Mesh Back, Arm	Z	8	3	23.5W x 19D x 43H	0.72	7	1,200	1,224	1,251	1,275	1,300	1,327	1,351	1,385	1,415	1,449	1,502	1,545	1,587	1,388	1,414	1,521	1,578	1,664	

To Order Select Below

1. Series

Series

Z ZEPHYR

2. Frame

Frame

7 ARMLESS BAR

8 ARM BAR

3. Style

Style

0 MESH SEAT/ MESH BACK

3 UPHOLSTERED SEAT/ MESH BACK

4. Glide

Glide

PG PLASTIC GLIDES

FG PLASTIC GLIDES WITH FELT PADS

5. Frame Finish

Powder Coat

BL BLUE	LG LIGHT GRAY	RO RED ORANGE
BM BLACK MATTE	MG MEADOW GREEN	RR RUSTY RED
BR BRASS	MK MILK	SB SOFT BLUE
BT BLACK TWILIGHT	MS METALLIC SILVER	SD SAND
CP CHAMPAGNE	NK NICKEL	TC TERRACOTTA
DB DARK BRONZE	NV NAVY	TP TAUPE
DG DARK GRAY	OR ORANGE	TS TEXTURED SLATE
DP DUSTY PINK	PY PALE YELLOW	YL YELLOW
FG FOREST GREEN	RD RED	

Other

CH CHROME ARMLESS **+287**

CH CHROME ARM **+315**

6. Mesh

Mesh

101 BLACK MESH ON BLACK NYLON UPHOLSTERY FRAMES

102 PLATINUM MESH ON GRAY/BEIGE NYLON UPHOLSTERY FRAMES

7. Upholstery

See general information section for details on textile program and COM/COL information.