

stylex

Yoom

PRICE LIST
November 01, 2024

General Information

STYLEX PRICE LIST

GENERAL INFORMATION

Terms

Net 30 days from date of invoice,
F. O. B . Delanco, New Jersey.

Damaged Shipments

All Stylex products are carefully inspected before they are packed in sturdy cartons designed to satisfy shipping requirements. Stylex is not responsible for damage in shipment. The transportation company assumes responsibility for delivering products to you in good condition when the bill of lading is signed. You protect yourself by refusing shipments showing damage or shortage until transportation company has noted on the delivery sheet the extent of damage or shortage. Concealed damage should be reported to the carrier as soon as discovered, but no later than 5 days after receiving shipment.

Return/Restocking Policy

Return shipments will not be accepted unless specifically authorized by Stylex in writing. The Return Authorization number should be clearly marked on the carton. The customer returning Stylex products is responsible for return shipping costs. Merchandise must be returned unused. Returned merchandise is subject to a 35% restocking fee.

Special Products

Modifications to standard products will be considered for large runs. Contact factory for price quotations.

Design Changes

In keeping with modern manufacturing advances, Stylex reserves the right to incorporate minor modifications and design changes in products without notice.

Cancellation/Change Order Policy

Regarding requests for order cancellation and/or order modification, please be advised that no charges will be applied before production, unless inventory has been specifically requisitioned to fulfill your order. Once orders proceed to the production phase, they cannot be altered or canceled under any circumstances. All requests for order cancellations or order changes must be submitted in writing and will only be considered valid upon approval by Stylex.

WARRANTY

Except as provided below, Stylex warrants exclusively to the original Purchaser of our product that all parts, under normal use and service, will be free from defects in workmanship and material for a period of ten (10) years from the date of purchase. "Normal use and service" means that the product will be used in a typical office environment for 40-45 hours per week.

This warranty is subject to the following limitations, exclusions and provisions:

Limitations involving materials and components:

Wood components of plywood stacking chairs
(such as Brooks and Welcome)
5 years

Upholstery

(including mesh used for Click, F4, Insight, and Zephyr Mesh)
3 years

SAVA Mesh

10 years

Pneumatic Cylinders

3 years

COM Upholstery

No warranty
Stylex makes every effort to ensure that the COM Upholstery it approves is suitable for the intended use. Nevertheless, we will not warrant, and assume no responsibility for, the durability or tailoring quality of any COM or COL . If you have any concerns about the ultimate appearance of any covering, please order an upholstered sample.

Painted Stack Chair Frames

No Warranty
We will not warrant the finish of painted stack chair frames against damage from stacking. Please order chrome frames for chairs that will be stacked.

Felt Glides

No warranty
Due to the different surfaces on which felt glides may be used, we cannot warrant their durability over time.

If this product fails during normal use and service within the applicable warranty period (other than through normal wear and tear), please submit a warranty claim at stylexdesign.com/warranty-claim/. Quantity, model details, description of issue, and Stylex certified labels are required for submission. PLEASE DO NOT RETURN PARTS OR THE PRODUCT TO STYLEX UNLESS INSTRUCTED TO DO SO BY STYLEX. Stylex will, at its discretion, either repair or replace the defective product or part at no cost. Labor requests must receive approval and will be authorized on a case-by-case basis. We will only reimburse for labor costs directly incurred, excluding any travel-related expenses. Purchaser may be required (at the option of Stylex) to return to Stylex at Purchaser's expense any defective part with all freight or shipping charges prepaid. The foregoing warranty shall be void if the product has been altered or repaired (other than by Stylex). The warranty does not cover damage to the product caused by accident, neglect, misuse, abuse, modification to the product by anyone other than Stylex or damage caused by use of the product for a purpose other than that for which it was designed. This warranty extends only to the original Purchaser of the product.

No Other Warranties

This warranty is in lieu of all other warranties, expressed or implied, including, but not limited to, implied warranties of merchantability and fitness for a particular purpose. The rights and remedies provided herein are the exclusive rights and remedies of the original purchaser of the product.

No Liability For Damages

In no event shall Stylex or its suppliers be responsible or liable for any special, indirect, consequential, or incidental damages. In no event shall the liability of Stylex exceed the actual purchase price paid to Stylex for the product.

Out of Warranty Products

For all products no longer covered by our warranty, please refer to our Design for Durability and Upgradability Policy. Contact your Account Manager if you would like to purchase any replaceable components to further extend the life of any Stylex seating product. This warranty applies to all Stylex products purchased on April 13, 2018, and thereafter.

PRODUCT TAKE BACK PROGRAM

In order to be good stewards of our products, Stylex offers a pathway towards a Product Take Back Program as a more viable solution to the end of our products' originally intended life.

Stylex supports the sustainable programs of ANEW and offers their added value to our clients through a comprehensive take-back solution for surplus office furniture and materials of any kind, in any condition. ANEW is a 501(c)(3) non-profit organization that exists to provide companies with smart, cost effective alternatives for their surplus furniture and other items with the priority of matching it to non- profits, public agencies and the underserved, within the local community of the project site. Corporate Social Responsibility is raised while the impact on the environment is lowered by diverting products and materials otherwise destined for landfill.

Stylex is proud to offer ANEW to customers dedicated to strengthening their community network by repurposing their furniture, fixtures and architectural materials to those in need. In 2014, Stylex committed to making this relationship a part of our strategic sales strategy. Visit www.anewfound.org to find out more.

To initiate a Product Take Back strategy through ANEW, contact Stylex Account Management at 800-257-5742.

For other end of life recovery options, please see our Product Disassembly Instructions and End of Life Recovery Options documents available on our website in the resources section of each product in our line.

FREIGHT PROGRAM

Freight charges will be calculated as a percentage of the net product price and added to the invoice at the time of shipment. The continental United States has been divided into three zones. Please use the map below to determine freight charges for the product's destination. Minimum freight charge is \$250. Please let us know if you will be shipping to a residential address or require inside delivery as this requires an additional fee. Also please note we need to be made aware if a liftgate is required prior to delivery. If any requests are made at the time of delivery, applicable charges will apply.



ZONE 1 - 4%

Connecticut
Delaware
New York
New Jersey
Maryland
Massachusetts
North Carolina
Ohio
Pennsylvania
Rhode Island
Virginia
Washington D.C.
West Virginia

ZONE 2 - 5%

Alabama
Arkansas
Canada, Ontario
Canada, Quebec
Florida
Georgia
Iowa
Illinois
Indiana
Kansas
Kentucky
Louisiana
Nebraska
New Hampshire
Oklahoma
Maine
Michigan
Minnesota
Missouri
Mississippi
South Carolina
Tennessee
Texas
Vermont
Wisconsin

ZONE 3 - 6%

Arizona
California
Colorado
Idaho
Montana
Nevada
New Mexico
North Dakota
Oregon
South Dakota
Utah
Washington
Wyoming

Quote Per Project

Alaska
Hawaii
Canada
(outside Ontario & Quebec)
Mexico

General Information

STYLEX PRICE LIST

TEXTILE PARTNERS & APPROVALS

Textile Partners

To customize your furniture performance needs and design vision, Stylex offers a wide selection of in-graded leathers and textiles from Grades A through Y. We've partnered with leading manufacturers on the options, focusing on color, price, durability, and construction. To view our partners and explore our digital carded program with broadly approved textiles, visit [this page](#). We stand by these textiles: They're tried and tested, and will effortlessly fit into any design aesthetic.

Textile Approvals

All textiles must be approved for the product you are specifying. For the related approved textile lists, visit [this page](#).

CAL 117 AND 133 COMPLIANCE

CAL 117-2013

CAL 117-2013 compliance is a requirement for all textiles applied on our seating products. All Stylex seating products meet this standard.

CAL 133

Most Stylex seating can be ordered to meet the requirements of CAL 133. When ordering, simply specify "CAL 133 compliance required". The upcharge for this option is \$54 list per yard. Please refer to the COM yardage of each model to determine the number of yards required. We do frequently require full-scale burn tests in order to certify CAL 133 before an order will be accepted. Such burn tests may increase normal lead times and do carry additional charges. Please contact your Stylex account manager for details.

CUSTOMER'S OWN MATERIAL/LEATHER

Customer's own material (COM) and customer's own leather (COL) will generally be upholstered at the price designated in each product's price list. Please be advised, however, that we specifically reserve the right to charge a higher price when we determine that special circumstances, such as unusual repeats or challenging materials, present themselves. All orders for custom coverings must be approved by Stylex before they will be accepted for production. To submit proposed textile for approval, please use the COM form [here](#).

Special Note:

We assume no responsibility for the durability or tailoring quality of any COM or COL. Directional covers in particular may not meet your satisfaction due to the design of certain products. Please be advised that COM and COL orders are not subject to return. If you have doubts about the ultimate appearance of certain coverings, please order a sample done with that specific COM or COL. In addition, while we inspect fabrics for mill imperfections, some are difficult to recognize. We cannot be responsible for defects, color inaccuracies, dye lot variations, or other flaws.

Under no circumstances will we be responsible for COM shortages, flaws, or other such problems. Finally, it is not our responsibility to police the receipt of COM's in order to meet delivery deadlines, and we assume our customers are aware of any undue delay in the shipment of their COM fabrics.

COM fabric and COL leather should be sent prepaid to: Stylex

**Attn: COM/COL - [Your Stylex PO #]
740 Coopertown Road
Delanco, NJ 08075**

All COM/COL sent to Stylex must be accompanied with a packing list which indicates the dealers' name, Stylex corresponding PO number, sales order number, COM/COL supplier name, textile pattern, colorway and shipped quantity. Stylex requires COM to be sent in as continuous yardage in the same dielot.

Yardage requirements shown in the price list are based on non-directional goods of 54" width. Fabrics less than 54" wide or those requiring matching (stripes, prints, or large patterned designs) call for additional yardage. We will be happy to supply yardage requirements for large quantities where economies may be realized.

Add the following yardage for stripes, plaids, or patterns with repeats:

Fabric Width	Plain Fabric	2-14" Repeat	15-24" Repeat	25-27" Repeat	28-36" Repeat
54"	0%	10%	15%	20%	25%
50"	10%	20%	25%	30%	35%
48"	15%	25%	30%	35%	40%
45"	40%	50%	55%	60%	65%
36"	50%	60%	65%	70%	75%

COM/COL FORM

To avoid delay in processing COM orders we request that you submit a sample of your COM textile stapled to this form which can be downloaded [here](#). If a textile has a stripe or design, the size of the repeat should be indicated. Please indicate the textile supplier's name, textile number, and color. Also indicate the Stylex product on which the textile will be used. If a certain direction of application is required, please ensure that information is communicated directly to your Stylex account manager.

The fabric supplier must indicate on his shipping labels the dealer name and purchase order number as well as the Stylex model number.

Please Note:

No order may be entered into production or have a shipping date assigned until all related COM is received at the factory.



CENTER OF STRIPE OR DESIGN

TOP OF CHAIR	TOP OF CHAIR
--------------	--------------

1. Size of Repeat

2. Textile Supplier

3. Textile Number

4. Color

5. Stylex Product

Contents

<hr/>		<hr/>	
COLORS, MATERIALS, AND FINISHES	5	IDEA STARTERS	13
<hr/>		<hr/>	
STATEMENT OF LINE	6	HOW TO ORDER	14
<hr/>		<hr/>	
OPTIONS AND UPHOLSTERY	7	YOOM: MODULAR	15
<hr/>		<hr/>	
POWER	8	YOOM: PRE-CONFIGURED	23
<hr/>		<hr/>	
SPECIFICATION INFORMATION	9	YOOM SOFT: MODULAR	30
<hr/>		<hr/>	
DIMENSIONS	11	YOOM SOFT: PRE-CONFIGURED	37
<hr/>		<hr/>	

CLICK THE TITLES ABOVE TO NAVIGATE THROUGH THE DOCUMENT
PRODUCT HEADERS ON SUBSEQUENT PAGES LINK BACK TO THIS PAGE

Yoom

COLORS, MATERIALS, AND FINISHES

POWDER COATED METAL

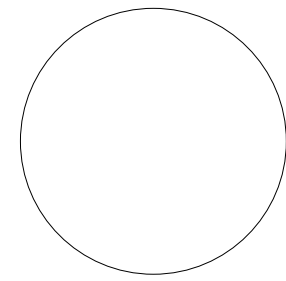

MILK
(MK)

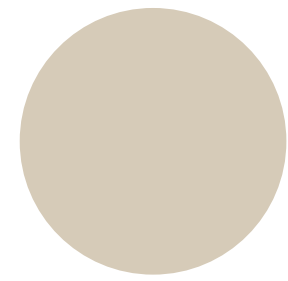

SAND
(SD)

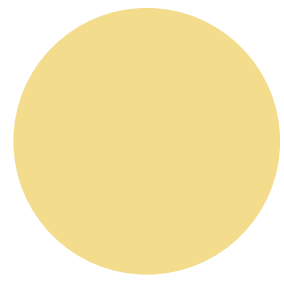

PALE YELLOW
(PY)

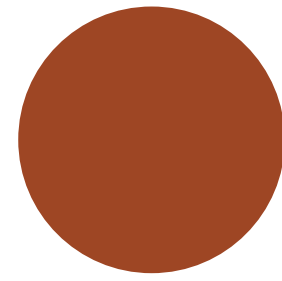

TERRACOTTA
(TC)

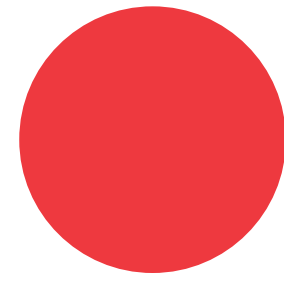

LIPSTICK RED
(LR)

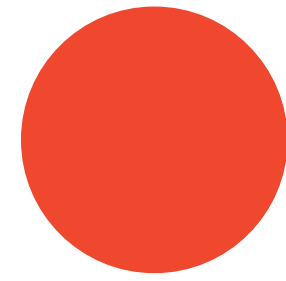

RED ORANGE
(RO)

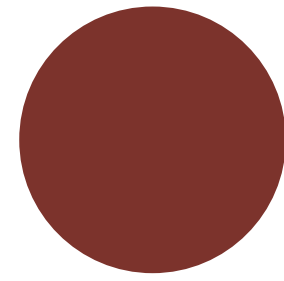

RUSTY RED
(RR)

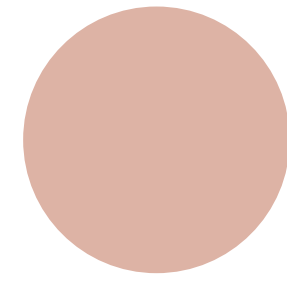

DUSTY PINK
(DP)



LIGHT PISTACHIO
(LP)

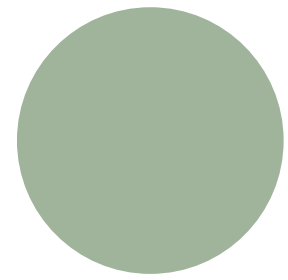

MEADOW GREEN
(MG)

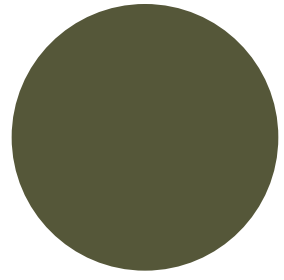

DARK SAGE
(DG)

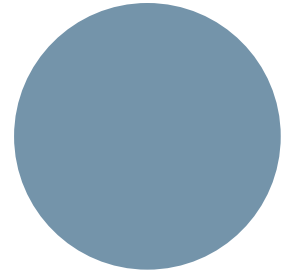

SOFT BLUE
(SB)

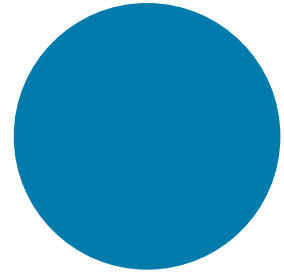

BLUE
(BL)

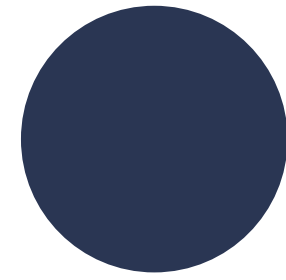

MIDNIGHT BLUE
(MB)



LILAC GRAY
(LL)

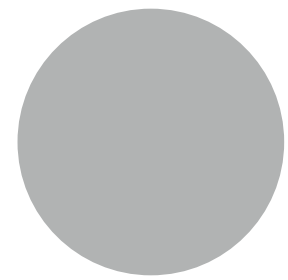

LIGHT GRAY
(LG)



CHAMPAGNE
(CP)

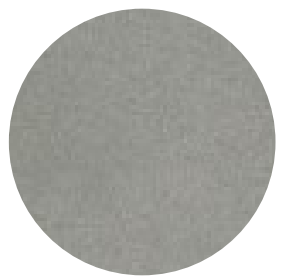

METALLIC SILVER
(MS)



NICKEL
(NK)

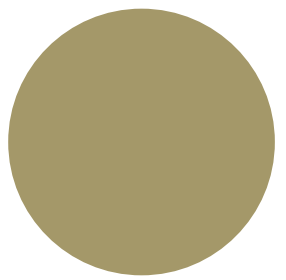

OCHRE
(OC)

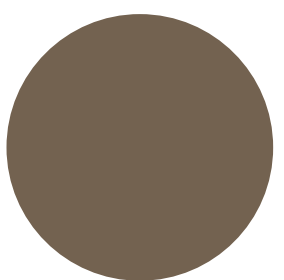

TAUPE
(TP)



DARK BRONZE
(DB)

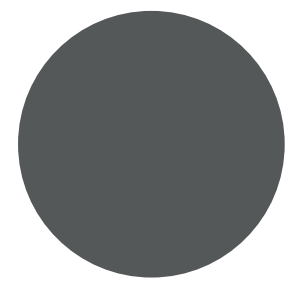

DARK GRAY
(DG)

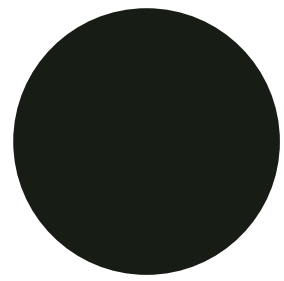

BLACK MATTE
(BM)



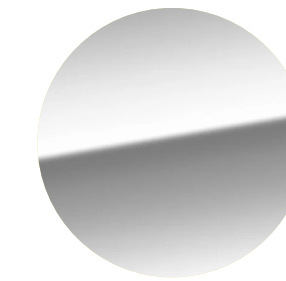







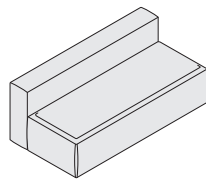
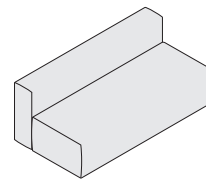
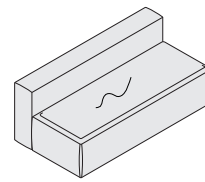
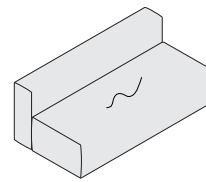
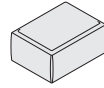
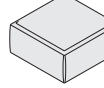
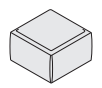
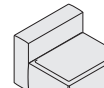
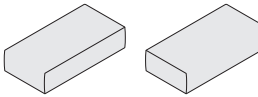
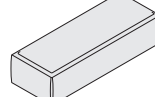
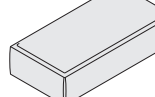
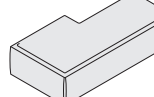
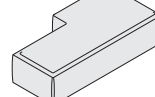
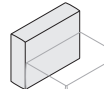
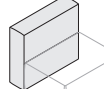
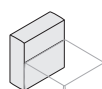
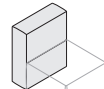
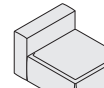
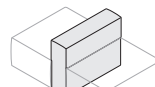
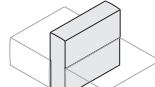
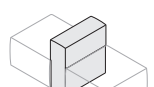
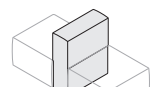



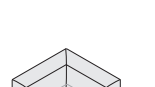
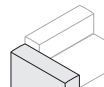
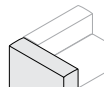
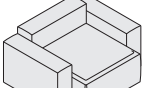



POLISHED METAL

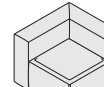

POLISHED
ALUMINUM
(AL)

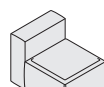
Yoom

SPECIFICATION GUIDE: STATEMENT OF LINE

OVERVIEW				
<p>Yoom is offered in the following 4 styles. All styles can be applied to the modular and stand-alone components below.</p>				
	<p>Yoom, Boxed</p> 	<p>Yoom, Rolled</p> 	<p>Yoom Soft, Boxed</p> 	<p>Yoom Soft, Rolled</p> 
MODULAR			PRE-CONFIGURED	
<p>Seats</p> <p>Single</p> 	<p>Single Full</p> 	<p>Single Narrow</p> 	<p>Single Chairs</p> <p>Single Armless</p> 	
<p>*Offered in rolled front and rolled side.</p> 	<p>Double*</p> 	<p>Double Full*</p> 	<p>Chaise Right*</p> 	<p>Chaise Left*</p> 
<p>Backs</p> <p>Single</p> 	<p>Single High</p> 	<p>Single Narrow</p> 	<p>Single Narrow High</p> 	<p>Single Full Armless</p> 
	<p>Single Thin Back to Back</p> 	<p>Single Thin Back to Back High</p> 	<p>Single Thin Back to Back Narrow</p> 	<p>Single Thin Back to Back Narrow High</p> 
	<p>Double</p> 	<p>Double High</p> 	<p>Single Back to Back</p> 	<p>Corner</p> 
<p>Arms</p> <p>Single Low</p> 	<p>Single High**</p> 	<p>**Single High Arm is the same model as Single High Back.</p>		<p>Single Full Low Arms</p> 
<p>Privacy Screens</p> <p>25"</p> 	<p>34"</p> 	<p>43"</p> 	<p>Single Full High Arms</p> 	
			<p>Double Chairs</p> <p>Double Armless</p> 	<p>Double Low Arms</p> 
			<p>Double High Arms</p> 	<p>Double Full Armless</p> 
			<p>Corner</p> 	<p>Double Full Low Arms</p> 
			<p>Narrow</p> 	<p>Double Full High Arms</p> 
			<p>Chaises</p>	<p>Chaise Right</p> 
				<p>Chaise Left</p> 

PRODUCT INFORMATION

Design

Stylex/Anthony Land

Construction

Yoom utilizes foam within its construction offering a tailored look, while Yoom Soft utilizes both foam and a down cover, creating a lived in, relaxed look with visible comfort wrinkles.

Glides

Yoom is available with 3 glide options: plastic (recommended for easier movement on carpet), felt (recommended for easier movement on hard floors), and rubber (recommended for static positioning). There is 1" of clearance between the floor and all Yoom components.

Casters

Yoom single seats and chairs (without arms) are available with 2 caster options: hard and soft.

Round Metal Legs

Yoom round metal legs increase seating height by 2". Legs are available in all standard Stylex powder paint and polished aluminum finishes.

Ganging

All individual units may be connected to one another with the use of a forked latch system. Yoom utilizes a ganging system that causes foam compression. For precise ganged layout dimensions, please reach out to: designapplication@stylexseating.com

Testing

Manufactured to comply with:
ANSI/BIFMA X5.4 Public and Lounge Seating Standard

Environment

Greenguard Gold Certified
LEVEL® 2

Yoom

SPECIFICATION GUIDE: OPTIONS AND UPHOLSTERY

OPTIONS

Glide Options

Plastic, Felt, or Rubber

Caster Options

Hard or Soft Wheel
(Available on Yoom single seats and chairs without arms only.)

Round Metal Leg

Available in standard Stylex powder paints and Polished AL

Ganging

Forked Latch System

UPHOLSTERY

PRODUCT INFORMATION

Design

Stylex/Anthony Land

Construction

Yoom utilizes foam within its construction offering a tailored look, while Yoom Soft utilizes both foam and a down cover, creating a lived in, relaxed look with visible comfort wrinkles.

Glides

Yoom is available with 3 glide options: plastic (recommended for easier movement on carpet), felt (recommended for easier movement on hard floors), and rubber (recommended for static positioning). There is 1" of clearance between the floor and all Yoom components.

Casters

Yoom single seats and chairs (without arms) are available with 2 caster options: hard and soft.

Round Metal Legs

Yoom round metal legs increase seating height by 2". Legs are available in all standard Stylex powder paint and polished aluminum finishes.

Ganging

All individual units may be connected to one another with the use of a forked latch system. Yoom utilizes a ganging system that causes foam compression. For precise ganged layout dimensions, please reach out to: designapplication@stylexseating.com

Testing

Manufactured to comply with:
ANSI/BIFMA X5.4 Public and Lounge Seating Standard





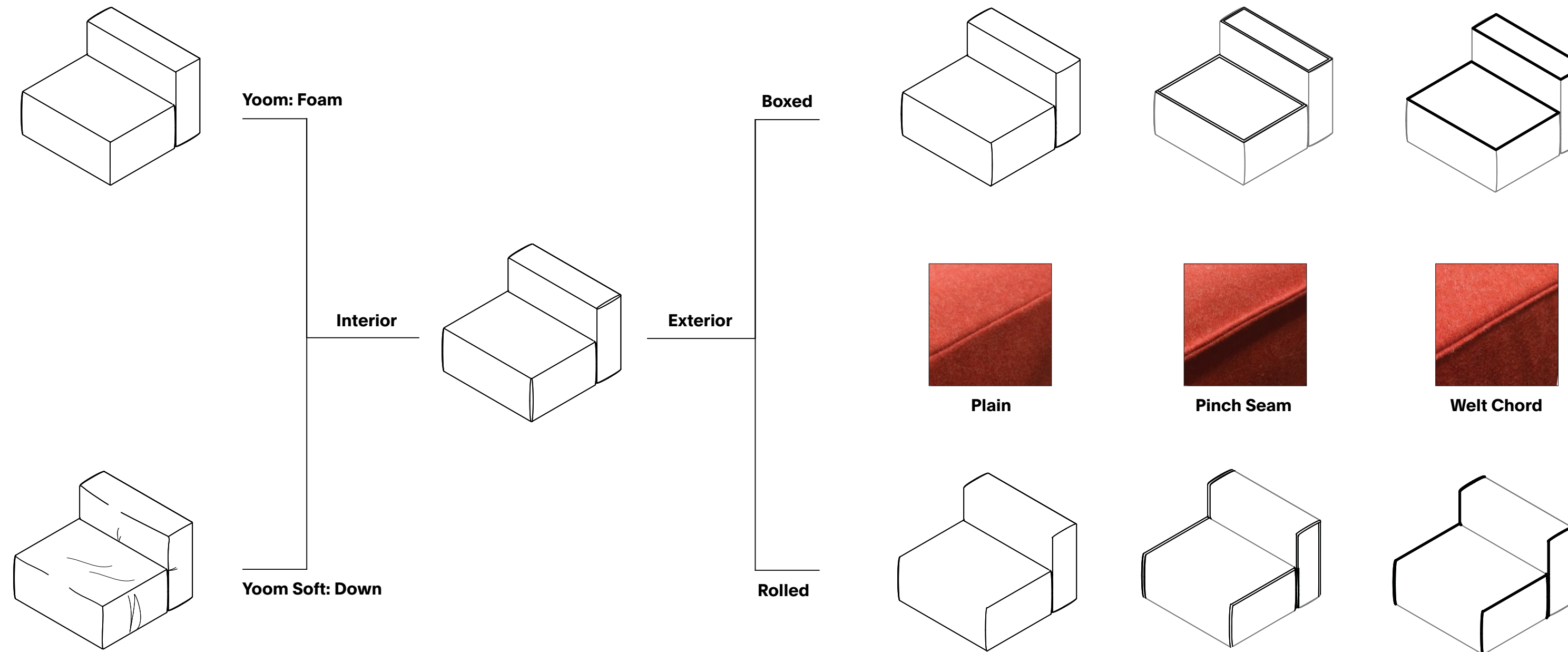



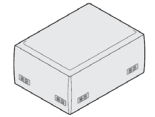
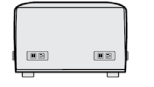
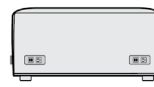
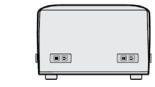
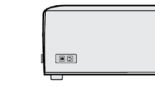
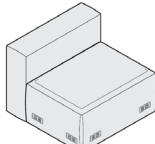

Environment

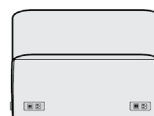
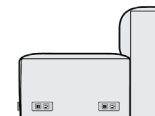
Greenguard Gold Certified
LEVEL® 2

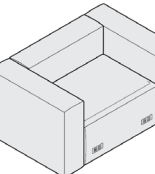
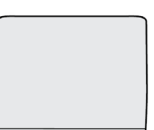
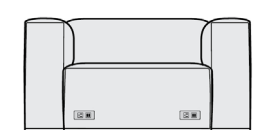

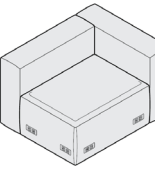
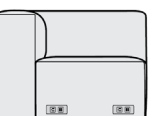
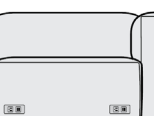
Yoom

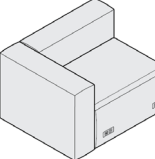
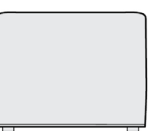
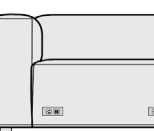
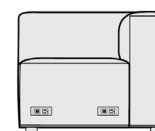
SPECIFICATION GUIDE: POWER

POWER PORTS	RIGHT	FRONT	LEFT	REAR
Single Seat 	Position 5 C15/C25  Position 4 C14/C24	Position 3 C13/C23  Position 2 C12/C22	Position 1 C11/C21  Position 8 C18/C28	Position 6 C16/C26  Position 7 C17/C27
Single Chair 	Position 5 C15/C25  Position 4 C14/C24	Position 3 C13/C23  Position 2 C12/C22	Position 1 C11/C21  Position 8 C18/C28	No Ports 
Single Chair w/ Arms 	No Ports 	Position 3 C13/C23  Position 2 C12/C22	No Ports 	No Ports 
Single Chair w/ Left Arm 	Position 5 C15/C25  Position 4 C14/C24	Position 3 C13/C23  Position 2 C12/C22	No Ports 	No Ports 
Single Chair w/ Right Arm 	No Ports 	Position 3 C13/C23  Position 2 C12/C22	Position 1 C11/C21  Position 8 C18/C28	No Ports 

To Order Power Select Below

1. Length and Harness End

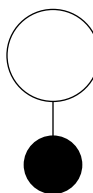

Length and Harness End

C1	10' CORD LENGTH W/NEMA 5-15P	+452
C2	20' CORD LENGTH W/NEMA 5-15P	+485
W1	12' BX WHIP (FOR HARDWIRING)	+1,122
W2	24' BX WHIP (FOR HARDWIRING)	+1,311

2. Position

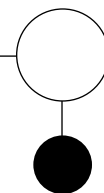

Position

1	POSITION 1
2	POSITION 2
3	POSITION 3
4	POSITION 4
5	POSITION 5
6	POSITION 6
7	POSITION 7
8	POSITION 8

See above for power port location restrictions

3. Power Port Finish

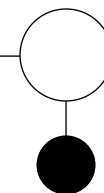

Standard Powder Coated Metal

BL	BLUE	LL	LILAC GRAY	OC	OCHRE
BM	BLACK MATTE	LP	LIGHT PISTACHIO	PY	PALE YELLOW
CP	CHAMPAGNE	LR	LIPSTICK RED	RO	RED ORANGE
DB	DARK BRONZE	MB	MIDNIGHT BLUE	RR	RUSTY RED
DG	DARK GRAY	MG	MEADOW GREEN	SB	SOFT BLUE
DP	DUSTY PINK	MK	MILK	SD	SAND
DS	DARK SAGE	MS	METALLIC SILVER	TC	TERRACOTTA
LG	LIGHT GRAY	NK	NICKEL	TP	TAUPE

PRODUCT INFORMATION

Design

In-Seat Power Ports With 10' or 20' Cord

Power Port Cord Length and Harness End

C1X has a 10' power cord w/ NEMA 5-15P

C2X has a 20' Power cord w/ NEMA 5-15P

W1X 12' BX whip (for hardwiring)

W1X 24' BX whip (for hardwiring)

Power Port Location

The power port location is determined by its last digit.

Examples:

- A C14 power port has a 10' power cord and is located on the right side of a chair, as determined from a seated position, or the right forward position of a bench.
- A C21 power port has a 20' power cord and is located on the left side of a chair, as determined from a seated position, or the left forward position of a bench.

Multiple power ports may be ordered per unit. The pricing shown is for each power port ordered.

In-Seat Power Port Finish

Select power port finish from one of the standard Stylex powder paints.

Power In Chairs And Benches

You can specify power units to be hardwired or equipped with a 3-prong plug. These units feature one USB-A port, one USB-C port, and a standard grounded 3-prong electrical outlet.

Yoom

SPECIFICATION GUIDE: ROLLED SIDE

ROLLED SIDE

Double Seat Rolled Side

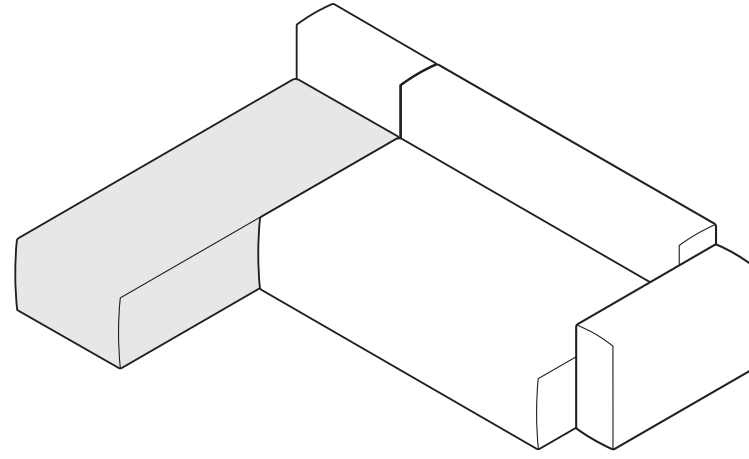

Double Full Seat Rolled Side

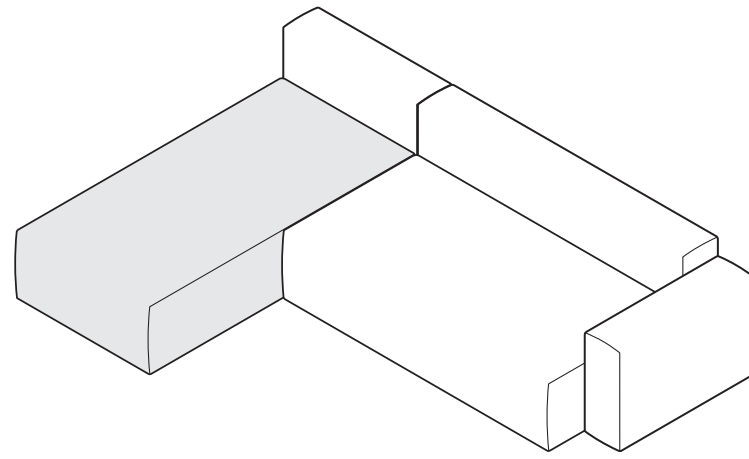

Chaise Seat (right shown) Rolled Side

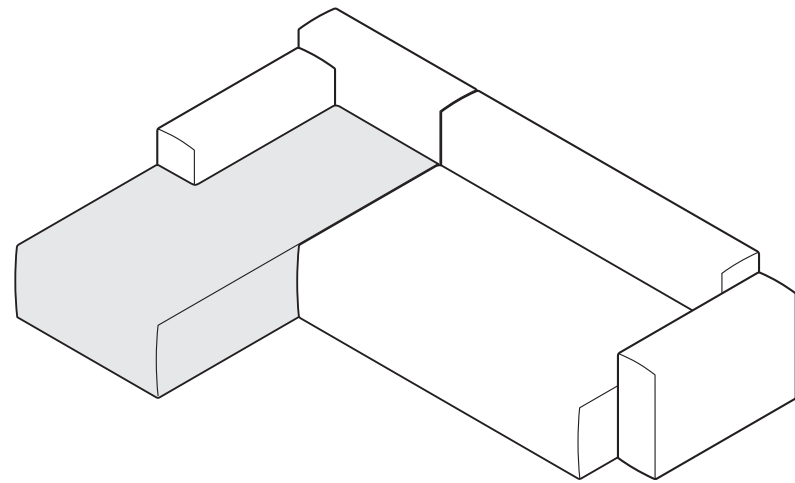

PRODUCT INFORMATION

Rolled Side

The option of a 'Rolled Side' is offered on Double Seats, Double Full Seats, Chaise Right, and Chaise Left units capping the end of a layout. Seam direction is altered from the standard 'Rolled Front' for a consistent pattern with adjacent seats. This enables striped and patterned fabrics to line up across units. Please refer to the sample layouts on this page as a reference for each 'Rolled Side' unit. Selection of rolled side units will be reviewed and suggested by Stylex per customer layout.

Yoom

SPECIFICATION GUIDE: PRIVACY SCREENS

PRIVACY SCREENS

YM061 25" Privacy Screen

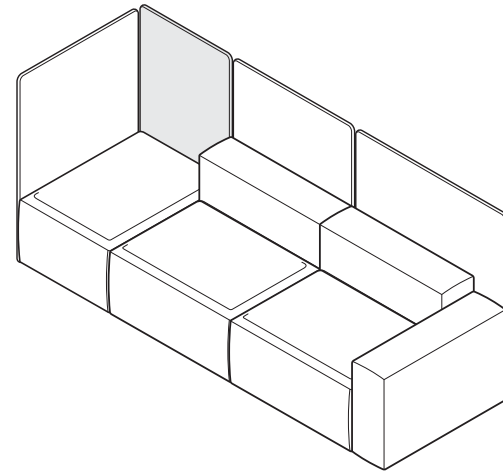

YM062 34" Privacy Screen

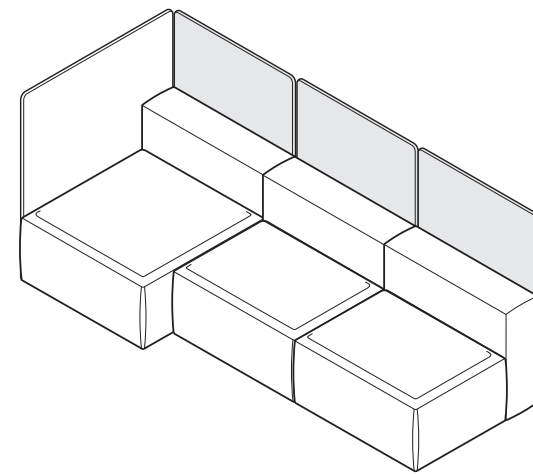
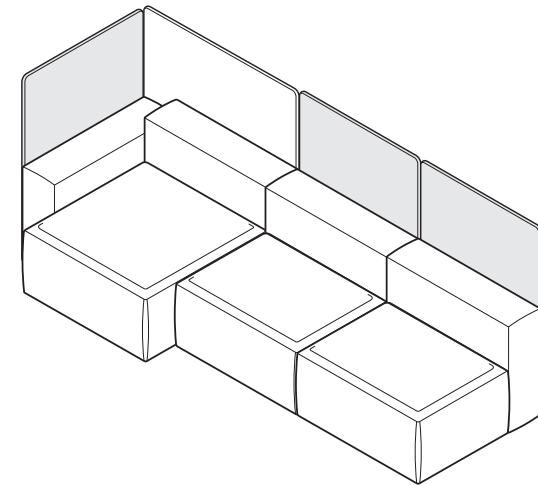
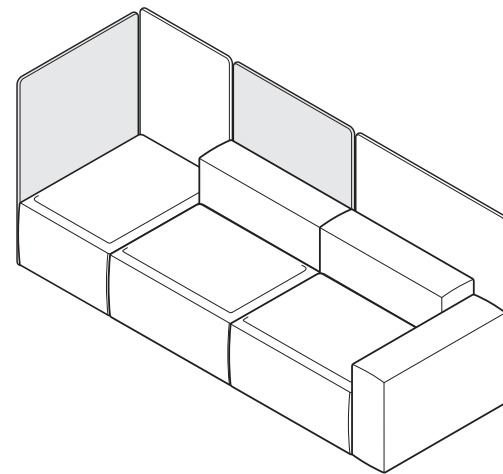

YM063 43" Privacy Screen

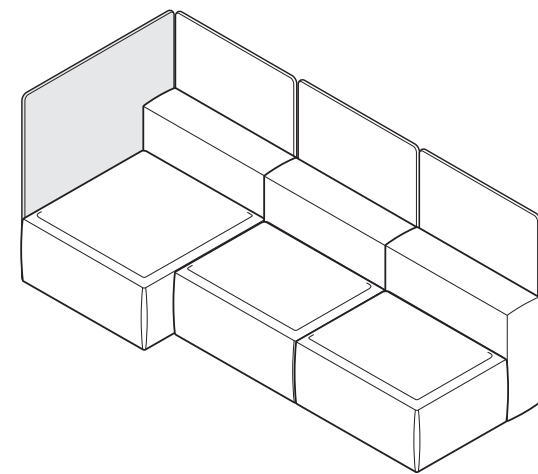
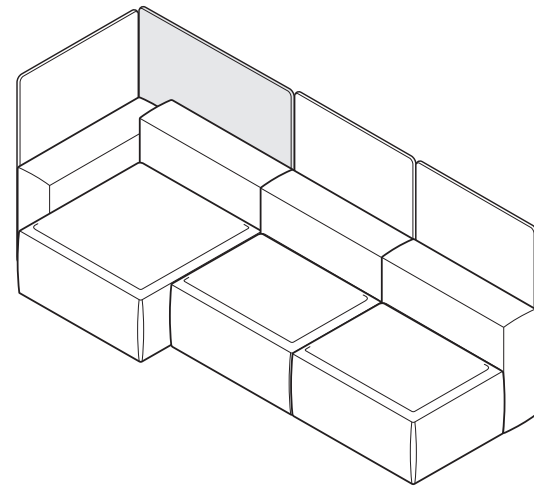

PRODUCT INFORMATION

Privacy Screens

Yoom Privacy Screens are field installed and can be installed on seats, backs and arms. They can be used to provide privacy and definition to the space or can be directly used as a back with throw pillows in lieu of the traditional Yoom Backs or Back to Backs. Three different privacy screen widths have been created to keep pace with the specifiers creativity.

Yoom

SPECIFICATION GUIDE: DIMENSIONS

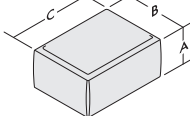
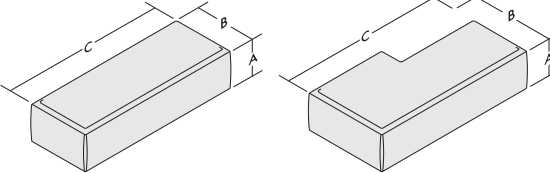
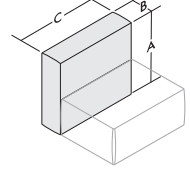
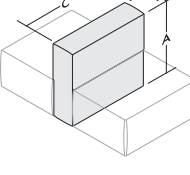
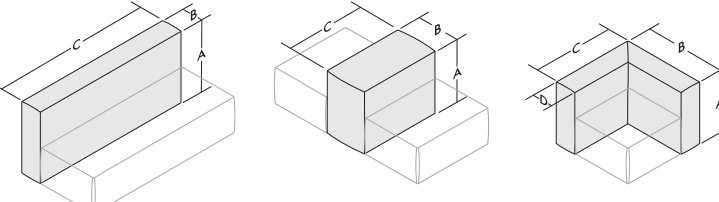
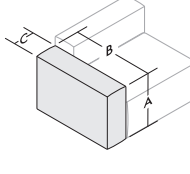
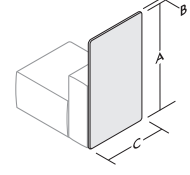
DIMENSIONS - YOOM	MODULAR (BOXED & ROLLED)			
Seats A. Height B. Depth C. Width  	Single A. 15" B. 27" C. 36"	Single Full A. 15" B. 36" C. 36"	Single Narrow A. 15" B. 27" C. 27"	
	Double A. 15" B. 27" C. 70"	Double Full A. 15" B. 36" C. 70"	Chaise Right A. 15" B. 36" C. 70"	Chaise Left A. 15" B. 36" C. 70"
Backs A. Height B. Depth C. Width D. Depth of Back (Corner)   	Single A. 26" B. 9" C. 36"	Single High A. 30" B. 9" C. 36"	Single Narrow A. 26" B. 9" C. 27"	Single Narrow High A. 30" B. 9" C. 27"
	Single Thin Back to Back A. 26" B. 9" C. 36"	Single Thin Back to Back High A. 30" B. 9" C. 36"	Single Thin Back to Back Narrow A. 26" B. 9" C. 27"	Single Thin Back to Back Narrow High A. 30" B. 9" C. 27"
	Double A. 26" B. 9" C. 70"	Double High A. 30" B. 9" C. 70"	Single Back to Back A. 26" B. 18" C. 36"	Corner A. 26" B. 36" C. 36" D. 9"
Arms A. Height B. Depth C. Width 	Single Low A. 22" B. 36" C. 10.5"			
Screens A. Height B. Depth C. Width 	25" A. 45" B. 1.5" C. 25"	34" A. 45" B. 1.5" C. 34"	43" A. 45" B. 1.5" C. 43"	

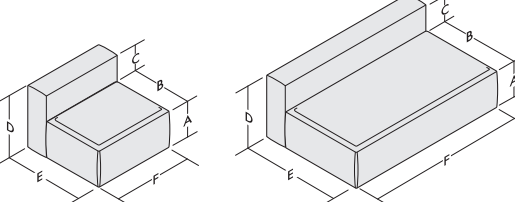
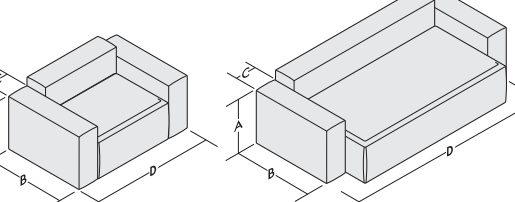
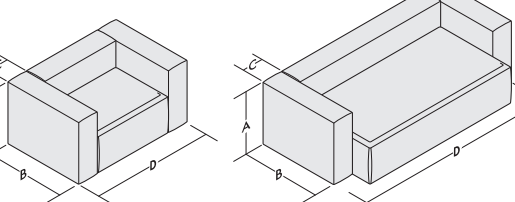
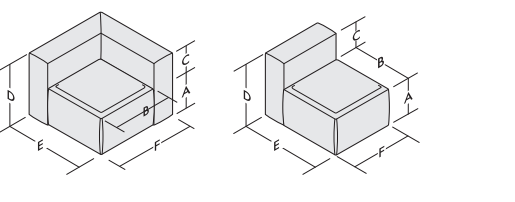
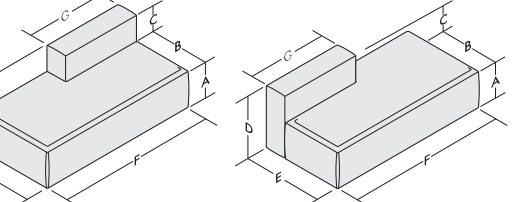
DIMENSIONS - YOOM	PRE-CONFIGURED (BOXED & ROLLED)					
Armless Chair A. Seat Height B. Seat Depth C. Back Height D. Overall Height E. Overall Depth F. Overall Width 	Single A. 15" B. 27" C. 11" D. 26" E. 36" F. 36"	Single Full A. 15" B. 36" C. 11" D. 26" E. 45" F. 36"			Double A. 15" B. 27" C. 11" D. 26" E. 36" F. 70"	Double Full A. 15" B. 36" C. 11" D. 26" E. 45" F. 70"
	Arm Low A. Arm Height B. Arm Depth C. Arm Width D. Overall Width Arms 	Single A. 22" B. 36" C. 10.5" D. 56"	Single Full A. 22" B. 36" C. 10.5" D. 56"	Single L/R Arm A. 22" B. 36" C. 10.5" D. 46"	Single Full L/R Arm A. 22" B. 36" C. 10.5" D. 46"	Double A. 22" B. 36" C. 10.5" D. 90"
Arm High A. Arm Height B. Arm Depth C. Arm Width D. Overall Width Arms 	Single A. 26" B. 36" C. 10.5" D. 56"	Single Full A. 26" B. 36" C. 10.5" D. 56"	Single L/R Arm A. 26" B. 36" C. 10.5" D. 46"	Single Full L/R Arm A. 26" B. 36" C. 10.5" D. 46"	Double A. 26" B. 36" C. 10.5" D. 90"	Double Full A. 26" B. 36" C. 10.5" D. 90"
	Corner & Single Narrow Chair A. Seat Height B. Seat Depth C. Back Height D. Overall Height E. Overall Depth F. Overall Width 	Corner A. 15" B. 25" C. 11" D. 26" E. 36" F. 36"	Single Narrow A. 15" B. 25" C. 11" D. 26" E. 36" F. 27"			
Chaise A. Seat Height B. Seat Depth C. Back Height D. Overall Height E. Overall Depth F. Overall Width G. Back Width 	Chaise Left or Right A. 15" B. 25" C. 11" D. 26" E. 36" F. 70" G. 36"					

Yoom Soft

SPECIFICATION GUIDE: DIMENSIONS

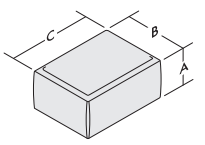
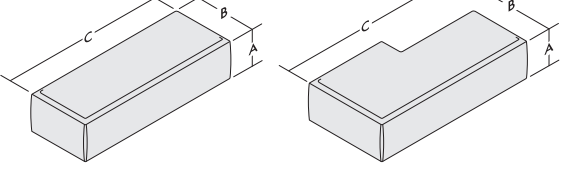
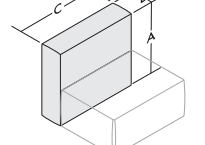
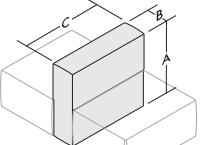
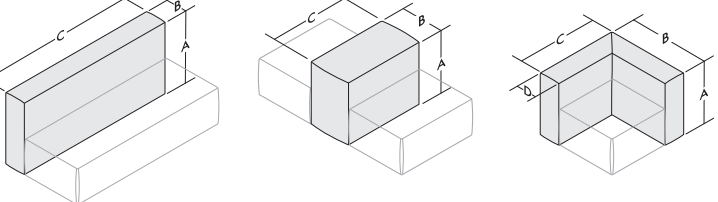
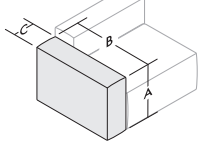
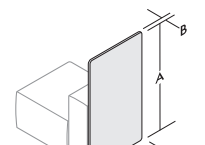
DIMENSIONS - YOOM SOFT	MODULAR (BOXED & ROLLED)			
Seats A. Height B. Depth C. Width  	Single A. 15" B. 27.25" C. 36.25"	Single Full A. 15" B. 36.25" C. 36.25"	Single Narrow A. 15" B. 27.25" C. 27.25"	
	Double A. 15" B. 27.25" C. 70.25"	Double Full A. 15" B. 36.25" C. 70.25"	Chaise Right A. 15" B. 36.25" C. 70.25"	Chaise Left A. 15" B. 36.25" C. 70.25"
Backs A. Height B. Depth C. Width D. Depth of Back (Corner)   	Single A. 26" B. 9" C. 36.25"	Single High A. 30" B. 9" C. 36.25"	Single Narrow A. 26" B. 9" C. 27.25"	Single Narrow High A. 30" B. 9" C. 27.25"
	Single Thin Back to Back A. 26" B. 9" C. 36.25"	Single Thin Back to Back High A. 30" B. 9" C. 36.25"	Single Thin Back to Back Narrow A. 26" B. 9" C. 27.25"	Single Thin Back to Back Narrow High A. 30" B. 9" C. 27.25"
	Double A. 26" B. 9" C. 70.25"	Double High A. 30" B. 9" C. 70.25"	Single Back to Back A. 26" B. 18" C. 36.25"	Corner A. 26" B. 36.25" C. 36.25" D. 9"
Arms A. Height B. Depth C. Width 	Single Low A. 22" B. 36.25" C. 10.375"			
Screens A. Height B. Depth C. Width 	25" A. 45" B. 1.5" C. 25"	34" A. 45" B. 1.5" C. 34"	43" A. 45" B. 1.5" C. 43"	

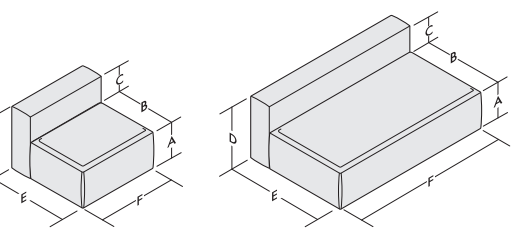
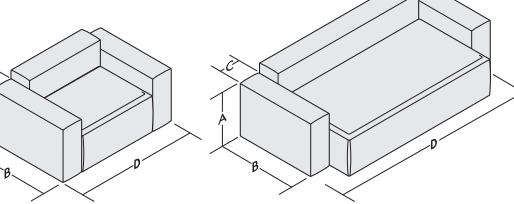
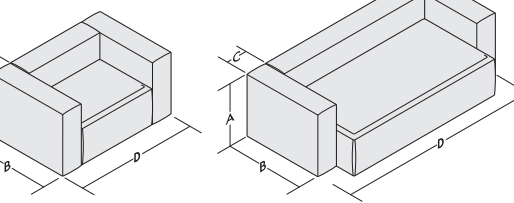
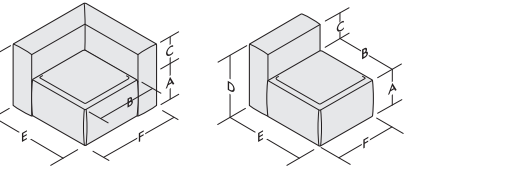
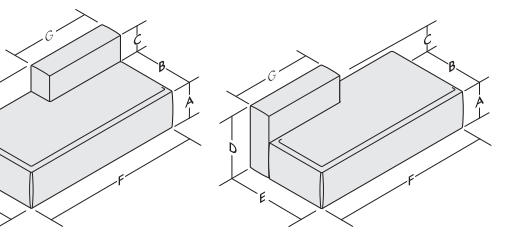
DIMENSIONS - YOOM SOFT	PRE-CONFIGURED (BOXED & ROLLED)					
Armless Chair A. Seat Height B. Seat Depth C. Back Height D. Overall Height E. Overall Depth F. Overall Width 	Single A. 15" B. 25" C. 11" D. 26" E. 36.25" F. 36.25"	Single Full A. 15" B. 34" C. 11" D. 26" E. 45.25" F. 36.25"			Double A. 15" B. 25" C. 11" D. 26" E. 36.25" F. 70.25"	Double Full A. 15" B. 34" C. 11" D. 26" E. 45.25" F. 70.25"
	Arm Low A. Arm Height B. Arm Depth C. Arm Width D. Overall Width Arms 	Single A. 22" B. 36.25" C. 10.375" D. 55.25"	Single Full A. 22" B. 36.25" C. 10.375" D. 55.25"	Single L/R Arm A. 22" B. 36.25" C. 10.375" D. 45.75"	Single Full L/R Arm A. 22" B. 36.25" C. 10.375" D. 45.75"	Double A. 22" B. 36.25" C. 10.375" D. 89.25"
Arm High A. Arm Height B. Arm Depth C. Arm Width D. Overall Width Arms 	Single A. 26" B. 36.25" C. 10.375" D. 55.25"	Single Full A. 26" B. 36.25" C. 10.375" D. 55.25"	Single L/R Arm A. 26" B. 36.25" C. 10.375" D. 45.75"	Single Full L/R Arm A. 26" B. 36.25" C. 10.375" D. 45.75"	Double A. 26" B. 36.25" C. 10.375" D. 89.25"	Double Full A. 26" B. 36.25" C. 10.375" D. 89.25"
	Corner & Single Narrow Chair A. Seat Height B. Seat Depth C. Back Height D. Overall Height E. Overall Depth F. Overall Width 	Corner A. 15" B. 25" C. 11" D. 26" E. 36.25" F. 36.25"	Single Narrow A. 15" B. 25" C. 11" D. 26" E. 36.25" F. 27.25"			
Chaise A. Seat Height B. Seat Depth C. Back Height D. Overall Height E. Overall Depth F. Overall Width G. Back Width 	Chaise Left or Right A. 15" B. 25" C. 11" D. 26" E. 36.25" F. 70.25" G. 36.25"					

Yoom

SPECIFICATION GUIDE: IDEA STARTERS

IDEA STARTERS

Idea Starter 1



Idea Starter 2



Idea Starter 3



Idea Starter 4



Idea Starter 5



Idea Starter 6



Idea Starter 7



Idea Starter 8



Idea Starter 9



Idea Starter 10



Idea Starter 11



Idea Starter 12



ORDERING GUIDE

Idea Starters Online and in CET

At Stylex, we have a constant eye towards making our products easy to specify. Our Design Application team is working on layouts every day, so we have built a library online of the most requested layouts, with all the accompanying information, files, and pricing. We believe these will make our products easier to specify, and in turn help kick start your project. You can also find these in CET, please check out our 'Idea Starters' tab on for the easiest way to drag-and-drop right into your layout. Visit [Stylexdesign.com/idea-starters](https://stylexdesign.com/idea-starters) to get started.

Yoom

SPECIFICATION GUIDE: HOW TO ORDER

MODEL CODE BREAKDOWN - SEATING

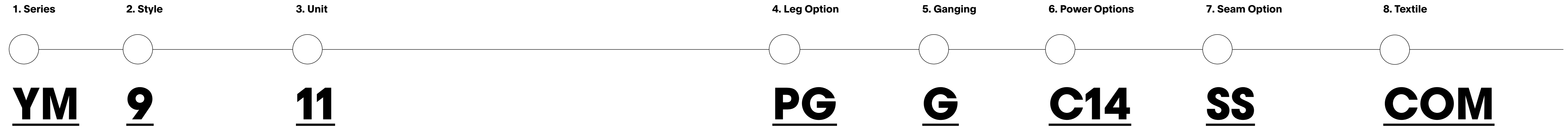

Sample Model Code: **YM911PGGC14SSCOM**



1. Series	2. Style	3. Unit		4. Leg Option	5. Ganging	6. Power Options	7. Seam Option	8. Textile
YM	9	11		PG	G	C14	SS	COM
Series YM YOOM	Style 4 SOFT ROLLED SIDE 5 SOFT ROLLED FRONT 6 SOFT BOXED 7 ROLLED SIDE 8 ROLLED FRONT 9 BOXED	Modular Units 11 SINGLE SEAT 12 SINGLE FULL SEAT 13 SINGLE NARROW SEAT 14 DOUBLE SEAT 15 DOUBLE FULL SEAT 16 CHAISE RIGHT 17 CHAISE LEFT 31 SINGLE BACK 32 SINGLE HIGH BACK 33 SINGLE NARROW BACK 34 DOUBLE BACK 35 DOUBLE HIGH BACK 36 SINGLE BACK TO BACK 37 CORNER BACK 38 SINGLE NARROW HIGH BACK 39 SINGLE THIN BACK TO BACK 40 SINGLE HIGH THIN BACK TO BACK 41 SINGLE NARROW THIN BACK TO BACK 42 SINGLE NARROW HIGH THIN BACK TO BACK 51 SINGLE LOW ARM 61 25" PRIVACY SCREEN 62 34" PRIVACY SCREEN 63 43" PRIVACY SCREEN	Pre-Configured Units 113100 SINGLE CHAIR ARMLESS 113131P SINGLE CHAIR WITH HIGH ARMS 113131R SINGLE CHAIR WITH RIGHT HIGH ARM 113131L SINGLE CHAIR WITH LEFT HIGH ARM 113151P SINGLE CHAIR WITH LOW ARMS 113151R SINGLE CHAIR WITH RIGHT LOW ARM 113151L SINGLE CHAIR WITH LEFT LOW ARM 123100 SINGLE FULL CHAIR ARMLESS 123131P SINGLE FULL CHAIR WITH HIGH ARMS 123131R SINGLE FULL CHAIR WITH RIGHT HIGH ARM 123131L SINGLE FULL CHAIR WITH LEFT HIGH ARM 123151P SINGLE FULL CHAIR WITH LOW ARMS 123151R SINGLE FULL CHAIR WITH RIGHT LOW ARM 123151L SINGLE FULL CHAIR WITH LEFT LOW ARM 143400 DOUBLE CHAIR ARMLESS 143431P DOUBLE CHAIR WITH HIGH ARMS 143451P DOUBLE CHAIR WITH LOW ARMS 153400 DOUBLE FULL CHAIR ARMLESS 153431P DOUBLE FULL CHAIR WITH HIGH ARMS 153451P DOUBLE FULL CHAIR WITH LOW ARMS 1631 CHAISE RIGHT WITH BACK 1731 CHAISE LEFT WITH BACK 1337 CORNER CHAIR 1333 NARROW CHAIR	Leg Options Glides PG PLASTIC GLIDE FG FELT GLIDE RG RUBBER GLIDE Casters CH HARD WHEEL CS SOFT WHEEL Note: Casters only available on single seats and chairs. Leg L1 ROUND LEG Note: Legs increase seating height by 2".	Ganging ~ NONE G GANGING	Cord Length and Connection Type C1 10' POWER CORD C2 20' POWER CORD W1 12' HARDWIRE W2 24' HARDWIRE Power Position 1 POSITION 1 2 POSITION 2 3 POSITION 3 4 POSITION 4 5 POSITION 5 6 POSITION 6 7 POSITION 7 8 POSITION 8 Power Port Color Standard Powder Coat See page 5 for standard powder coat offerings.	Seam Options SS SINGLE SEAM ON ALL EDGES SP PINCH SEAM ON TOP EDGES SW STANDARD WELT CORD ON ALL EDGES	Textile Grades COM CUSTOMER'S OWN MATERIAL A GRADE A B GRADE B C GRADE C D GRADE D E GRADE E F GRADE F G GRADE G H GRADE H I GRADE I J GRADE J K GRADE K L GRADE L M GRADE M Leather Grades COL CUSTOMER'S OWN LEATHER W GRADE W X GRADE X Y GRADE Y E1 GRADE E1 E2 GRADE E2 Note: Leather only available on Yoom Soft units.

Yoom

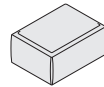
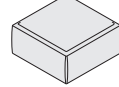
MODULAR: SEATS

TITLE	SERIES	STYLE	UNIT	DIMENSIONS	Textile Upholstery Grades															
					YDG	COM	A	B	C	D	E	F	G	H	I	J	K	L	M	
Single Seat 	Boxed	YM	9	11	36W x 27D x 15H	2.5	1,637	1,842	1,952	2,061	2,170	2,284	2,403	2,527	2,670	2,858	3,079	3,300	3,520	3,743
	Rolled Front	YM	8	11	36W x 27D x 15H	2.5	1,637	1,831	1,942	2,045	2,149	2,256	2,373	2,489	2,625	2,804	3,017	3,230	3,437	3,650
Single Full Seat 	Boxed	YM	9	12	36W x 36D x 15H	3.3	1,949	2,215	2,361	2,502	2,647	2,790	2,949	3,110	3,297	3,540	3,829	4,119	4,406	4,695
	Rolled Front	YM	8	12	36W x 36D x 15H	3.3	1,949	2,215	2,361	2,502	2,647	2,790	2,949	3,110	3,297	3,540	3,829	4,119	4,406	4,695
Single Narrow Seat 	Boxed	YM	9	13	27W x 27D x 15H	1.7	1,326	1,461	1,532	1,603	1,676	1,748	1,827	1,905	2,000	2,122	2,266	2,412	2,554	2,699
	Rolled Front	YM	8	13	27W x 27D x 15H	2	1,326	1,487	1,572	1,657	1,742	1,830	1,927	2,022	2,133	2,281	2,453	2,627	2,800	2,974

To Order Select Below

1. Series/Style

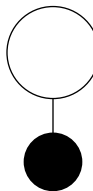

YM9

**Yoom
Boxed**

YM8

**Yoom
Rolled Front**

2. Unit

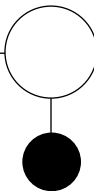

Unit

11 SINGLE SEAT

12 SINGLE FULL SEAT

13 SINGLE NARROW SEAT

3. Seam Options

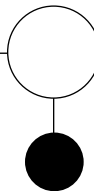

Seam Options

SS SINGLE SEAM ON ALL EDGES

SP PINCH SEAM ON TOP EDGES
SINGLE SEAM ON SIDE EDGES

SW STANDARD WELT CORD
ON ALL EDGES **+10% OF
COM LIST**

4. Glides/Casters/Legs

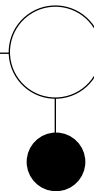

Glides

PG PLASTIC GLIDE

FG FELT GLIDE

RG RUBBER GLIDE

Glide Recommendations
For easier movement, order Plastic
Glides for carpet, Felt Glides for hard
floors and Rubber Glides for static
positioning.

Casters

CH HARD WHEEL CASTER **+93**

CS SOFT WHEEL CASTER **+93**

Recommended for mobility in
collaborative settings.

Legs

L1 ROUND METAL LEGS **+162**

Round Legs increase seating height by 2".
Round Legs are available in standard Stylex
powder coated painted metal finishes and
Polished Aluminum.

5. Power

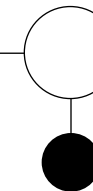

Power

Refer to power
ordering steps
on [page 8](#).

6. Options

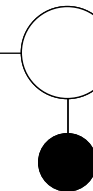

Options

G GANGING

7. Upholstery

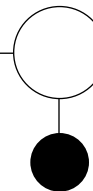

Upholstery

See [general information
section for details on textile
program and COM/COL
information.](#)

Yoom Rolled textiles must be cut up
the roll. Yoom is designed to have a
casual look and feel. It is meant to
show wrinkling with most fabrics.

To specify leather, use Yoom Soft
found on [page 30](#).

Yoom

MODULAR: SEATS

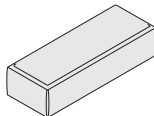
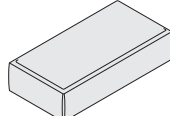
TITLE	SERIES	STYLE	UNIT	DIMENSIONS	YDG	Textile Upholstery Grades														
						COM	A	B	C	D	E	F	G	H	I	J	K	L	M	
Double Seat 	Boxed	YM	9	14	70W x 27D x 15H	4.4	2,728	3,084	3,277	3,465	3,659	3,851	4,063	4,276	4,525	4,851	5,237	5,621	6,003	6,393
	Rolled Front	YM	8	14	70W x 27D x 15H	4.3	2,728	3,076	3,267	3,448	3,635	3,823	4,030	4,239	4,479	4,796	5,174	5,552	5,921	6,298
	Rolled Side	YM	7	14	70W x 27D x 15H	5.5	2,728	3,174	3,414	3,649	3,892	4,133	4,397	4,661	4,976	5,381	5,865	6,348	6,822	7,307
Double Full Seat 	Boxed	YM	9	15	70W x 36D x 15H	5.5	3,351	3,798	4,038	4,273	4,516	4,758	5,022	5,287	5,599	6,003	6,488	6,971	7,445	7,930
	Rolled Front	YM	8	15	70W x 36D x 15H	4.3	3,351	3,699	3,890	4,070	4,259	4,448	4,654	4,862	5,103	5,420	5,797	6,176	6,546	6,923
	Rolled Side	YM	7	15	70W x 36D x 15H	5.5	3,351	3,798	4,038	4,273	4,516	4,758	5,022	5,287	5,599	6,003	6,488	6,971	7,445	7,930

To Order Select Below

1. Series/Style

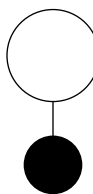

YM9

**Yoom
Boxed**

YM8

**Yoom
Rolled Front**

YM7

**Yoom
Rolled Side**

See [page 9](#) for more information on rolled side specification.

2. Unit

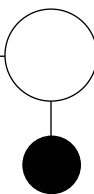

Unit

14 DOUBLE SEAT

15 DOUBLE FULL SEAT

3. Seam Options

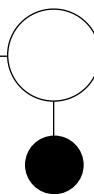

Seam Options

SS SINGLE SEAM ON ALL EDGES

SP PINCH SEAM ON TOP EDGES
SINGLE SEAM ON SIDE EDGES

SW STANDARD WELT CORD ON ALL EDGES **+10% OF COM LIST**

4. Glides/Casters/Legs

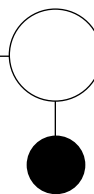

Glides

PG PLASTIC GLIDE

FG FELT GLIDE

RG RUBBER GLIDE

Glide Recommendations
For easier movement, order Plastic Glides for carpet, Felt Glides for hard floors and Rubber Glides for static positioning.

Legs

L1 ROUND METAL LEGS **+162**

Round Legs increase seating height by 2". Round Legs are available in standard Stylex powder coated painted metal finishes and Polished Aluminum.

5. Power

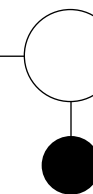

Power

Refer to power ordering steps on [page 8](#).

6. Options

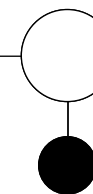

Options

G GANGING

7. Upholstery

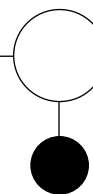

Upholstery

See [general information section](#) for details on textile program and COM/COL information.

Yoom Rolled textiles must be cut up the roll. Yoom is designed to have a casual look and feel. It is meant to show wrinkling with most fabrics.

To specify leather, use Yoom Soft found on [page 30](#).

Yoom

MODULAR: SEATS

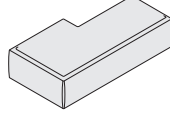
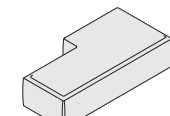
TITLE	SERIES	STYLE	UNIT	DIMENSIONS	YDG	Textile Upholstery Grades														
						COM	A	B	C	D	E	F	G	H	I	J	K	L	M	
Chaise Right Seat 	Boxed	YM	9	16	70W x 36/27D x 15H	5.2	3,351	3,771	3,998	4,217	4,446	4,673	4,920	5,172	5,464	5,847	6,298	6,754	7,200	7,655
	Rolled Front	YM	8	16	70W x 36/27D x 15H	5	3,351	3,761	3,983	4,198	4,421	4,644	4,888	5,131	5,419	5,793	6,237	6,681	7,119	7,563
	Rolled Side	YM	7	16	70W x 36/27D x 15H	5.5	3,351	3,798	4,038	4,273	4,516	4,758	5,022	5,287	5,599	6,003	6,488	6,971	7,445	7,930
Chaise Left Seat 	Boxed	YM	9	17	70W x 36/27D x 15H	5.2	3,351	3,771	3,998	4,217	4,446	4,673	4,920	5,172	5,464	5,847	6,298	6,754	7,200	7,655
	Rolled Front	YM	8	17	70W x 36/27D x 15H	5	3,351	3,761	3,983	4,198	4,421	4,644	4,888	5,131	5,419	5,793	6,237	6,681	7,119	7,563
	Rolled Side	YM	7	17	70W x 36/27D x 15H	5.5	3,351	3,798	4,038	4,273	4,516	4,758	5,022	5,287	5,599	6,003	6,488	6,971	7,445	7,930

To Order Select Below

1. Series/Style

- Yoom Boxed**
- Yoom Rolled Front**
- Yoom Rolled Side**

See [page 9](#) for more information on rolled side specification.

2. Unit

- Unit**
- 16 CHAISE RIGHT SEAT
- 17 CHAISE LEFT SEAT

3. Seam Options

- Seam Options**
- SS SINGLE SEAM ON ALL EDGES
- SP PINCH SEAM ON TOP EDGES
SINGLE SEAM ON SIDE EDGES
- SW STANDARD WELT CORD ON ALL EDGES **+10% OF COM LIST**

4. Glides/Casters/Legs

- Glides**
- PG PLASTIC GLIDE
- FG FELT GLIDE
- RG RUBBER GLIDE
- Glide Recommendations**
For easier movement, order Plastic Glides for carpet, Felt Glides for hard floors and Rubber Glides for static positioning.

5. Power

- Power**
- L1 ROUND METAL LEGS **+162**
- Round Legs increase seating height by 2". Round Legs are available in standard Stylex powder coated painted metal finishes and Polished Aluminum.

6. Options

- Options**
- G GANGING

7. Upholstery

- Upholstery**
- See [general information section](#) for details on textile program and COM/COL information.
- Yoom Rolled textiles must be cut up the roll. Yoom is designed to have a casual look and feel. It is meant to show wrinkling with most fabrics.
- To specify leather, use Yoom Soft found on [page 30](#).

Yoom

MODULAR: BACKS

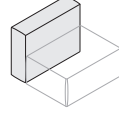
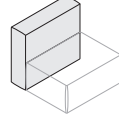
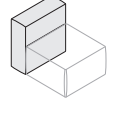
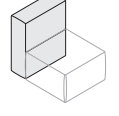
TITLE	SERIES	STYLE	UNIT	DIMENSIONS	Textile Upholstery Grades															
					YDG	COM	A	B	C	D	E	F	G	H	I	J	K	L	M	
Single Back/ Single Arm High 	Boxed	YM	9	31	36W x 9D x 26H	2.2	935	1,114	1,208	1,304	1,400	1,498	1,604	1,710	1,832	1,995	2,188	2,383	2,572	2,767
	Rolled Front	YM	8	31	36W x 9D x 29H	2.1	935	1,106	1,196	1,284	1,377	1,468	1,571	1,669	1,789	1,944	2,126	2,312	2,493	2,673
Single High Back 	Boxed	YM	9	32	36W x 9D x 30H	2.5	1,013	1,207	1,317	1,419	1,525	1,633	1,749	1,868	2,003	2,181	2,392	2,606	2,814	3,026
	Rolled Front	YM	8	32	36W x 9D x 30H	2.3	1,013	1,202	1,302	1,400	1,502	1,604	1,713	1,827	1,957	2,126	2,332	2,532	2,733	2,936
Single Narrow Back 	Boxed	YM	9	33	27W x 9D x 26H	1.7	858	989	1,064	1,134	1,205	1,280	1,358	1,439	1,532	1,655	1,798	1,944	2,088	2,231
	Rolled Front	YM	8	33	27W x 9D x 26H	2.1	858	1,028	1,117	1,206	1,300	1,390	1,492	1,592	1,711	1,868	2,049	2,234	2,415	2,596
Single Narrow High Back 	Boxed	YM	9	38	27W x 9D x 30H	1.8	1,013	1,154	1,232	1,308	1,385	1,463	1,548	1,634	1,734	1,862	2,018	2,170	2,323	2,477
	Rolled Front	YM	8	38	27W x 9D x 30H	1.8	1,013	1,154	1,232	1,308	1,385	1,463	1,548	1,634	1,734	1,862	2,018	2,170	2,323	2,477

To Order Select Below

1. Series/Style

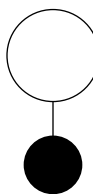

YM9

**Yoom
Boxed**

YM8

**Yoom
Rolled Front**

2. Unit

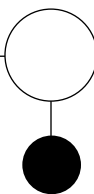

Unit

31 SINGLE BACK/SINGLE ARM HIGH

32 SINGLE HIGH BACK

33 SINGLE NARROW BACK

38 SINGLE NARROW HIGH BACK

3. Seam Options

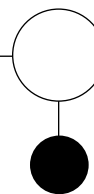

Seam Options

SS SINGLE SEAM ON ALL EDGES

SP PINCH SEAM ON TOP EDGES
SINGLE SEAM ON SIDE EDGES

SW STANDARD WELT CORD ON ALL EDGES **+10% OF COM LIST**

4. Upholstery

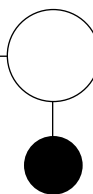

Upholstery

See general information section for details on textile program and COM/COL information.

Yoom Rolled textiles must be cut up the roll. Yoom is designed to have a casual look and feel. It is meant to show wrinkling with most fabrics.

To specify leather, use Yoom Soft found on **page 30**.

Yoom

MODULAR: BACKS

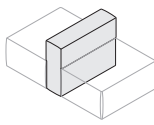
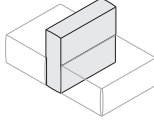
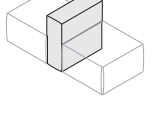
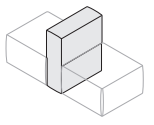
TITLE	SERIES	STYLE	UNIT	DIMENSIONS	Textile Upholstery Grades																
					YDG	COM	A	B	C	D	E	F	G	H	I	J	K	L	M		
Single Thin Back to Back 	Boxed	YM	9	39	36W x 9D x 26H	2.1	1,091	1,259	1,353	1,441	1,533	1,624	1,725	1,827	1,945	2,099	2,284	2,466	2,647	2,832	
	Rolled Front	YM	8	39	36W x 9D x 26H	2.1	1,091	1,259	1,353	1,441	1,533	1,624	1,725	1,827	1,945	2,099	2,284	2,466	2,647	2,832	
Single Thin Back to Back High 	Boxed	YM	9	40	36W x 9D x 30H	2.2	1,248	1,425	1,522	1,616	1,712	1,809	1,916	2,022	2,146	2,309	2,502	2,695	2,885	3,078	
	Rolled Front	YM	8	40	36W x 9D x 30H	2.2	1,248	1,425	1,522	1,616	1,712	1,809	1,916	2,022	2,146	2,309	2,502	2,695	2,885	3,078	
Single Thin Back to Back Narrow 	Boxed	YM	9	41	27W x 9D x 26H	1.6	1,091	1,218	1,283	1,350	1,416	1,486	1,559	1,634	1,720	1,832	1,970	2,104	2,239	2,374	
	Rolled Front	YM	8	41	27W x 9D x 26H	1.6	1,091	1,218	1,283	1,350	1,416	1,486	1,559	1,634	1,720	1,832	1,970	2,104	2,239	2,374	
Single Thin Back to Back Narrow High 	Boxed	YM	9	42	27W x 9D x 30H	1.6	1,248	1,372	1,440	1,505	1,572	1,639	1,715	1,789	1,876	1,990	2,125	2,261	2,394	2,530	
	Rolled Front	YM	8	42	27W x 9D x 30H	1.8	1,248	1,389	1,467	1,543	1,618	1,697	1,782	1,869	1,967	2,097	2,253	2,404	2,556	2,712	

To Order Select Below

1. Series/Style

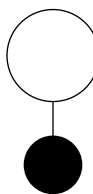

YM9

**Yoom
Boxed**

YM8

**Yoom
Rolled Front**

2. Unit

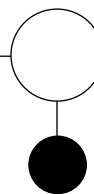

Unit

39 SINGLE THIN BACK TO BACK

40 SINGLE THIN BACK TO BACK HIGH

41 SINGLE THIN BACK TO BACK NARROW

42 SINGLE THIN BACK TO BACK NARROW HIGH

3. Seam Options

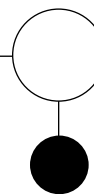

Seam Options

SS SINGLE SEAM ON ALL EDGES

SP PINCH SEAM ON TOP EDGES
SINGLE SEAM ON SIDE EDGES

SW STANDARD WELT CORD ON ALL EDGES **+10% OF COM LIST**

4. Upholstery

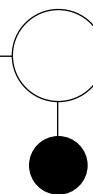

Upholstery

See general information section for details on textile program and COM/COL information.

Yoom Rolled textiles must be cut up the roll. Yoom is designed to have a casual look and feel. It is meant to show wrinkling with most fabrics.

To specify leather, use Yoom Soft found on **page 30**.

Yoom

MODULAR: BACKS

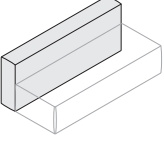
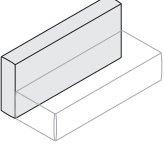
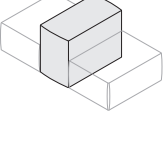
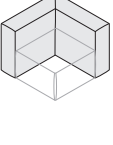
TITLE	SERIES	STYLE	UNIT	DIMENSIONS	Textile Upholstery Grades															
					YDG	COM	A	B	C	D	E	F	G	H	I	J	K	L	M	
Double Back 	Boxed	YM	9	34	70W x 9D x 26H	4.4	1,715	2,071	2,265	2,451	2,645	2,839	3,050	3,262	3,512	3,837	4,224	4,609	4,989	5,376
	Rolled Front	YM	8	34	70W x 9D x 26H	4.1	1,715	2,046	2,224	2,398	2,576	2,753	2,949	3,148	3,377	3,678	4,035	4,393	4,744	5,102
Double High Back 	Boxed	YM	9	35	70W x 9D x 30H	4.8	1,949	2,333	2,538	2,741	2,948	3,156	3,385	3,611	3,879	4,230	4,646	5,061	5,471	5,886
	Rolled Front	YM	8	35	70W x 9D x 30H	4.7	1,949	2,320	2,527	2,724	2,926	3,127	3,350	3,574	3,837	4,176	4,581	4,988	5,387	5,794
Single Back to Back 	Boxed	YM	9	36	36W x 18D x 26H	3.3	1,248	1,515	1,660	1,799	1,945	2,090	2,247	2,408	2,595	2,839	3,127	3,416	3,704	3,995
	Rolled Front	YM	8	36	36W x 18D x 26H	3.2	1,248	1,505	1,644	1,780	1,922	2,062	2,215	2,370	2,551	2,786	3,065	3,347	3,623	3,902
Corner Back 	Boxed	YM	9	37	36W x 36D x 26H	3.5	1,403	1,687	1,844	1,993	2,148	2,303	2,473	2,643	2,841	3,100	3,409	3,720	4,023	4,332
	Rolled Front	YM	8	37	36W x 36D x 26H	3.3	1,403	1,681	1,829	1,973	2,124	2,274	2,437	2,604	2,797	3,048	3,347	3,646	3,943	4,242

To Order Select Below

1. Series/Style

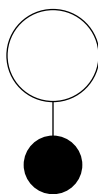

YM9

**Yoom
Boxed**

YM8

**Yoom
Rolled Front**

2. Unit

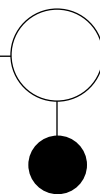

Unit

34 DOUBLE BACK

35 DOUBLE HIGH BACK

36 SINGLE BACK TO BACK

37 CORNER BACK

3. Seam Options

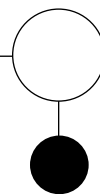

Seam Options

SS SINGLE SEAM ON ALL EDGES

SP PINCH SEAM ON TOP EDGES
SINGLE SEAM ON SIDE EDGES

SW STANDARD WELT CORD ON ALL EDGES **+10% OF COM LIST**

4. Upholstery

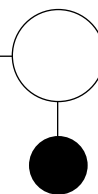

Upholstery

See general information section for details on textile program and COM/COL information.

Yoom Rolled textiles must be cut up the roll. Yoom is designed to have a casual look and feel. It is meant to show wrinkling with most fabrics.

To specify leather, use Yoom Soft found on [page 30](#).

Yoom

MODULAR: ARMS

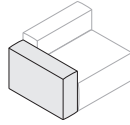
TITLE	SERIES	STYLE	UNIT	DIMENSIONS	Textile Upholstery Grades															
					YDG	COM	A	B	C	D	E	F	G	H	I	J	K	L	M	
Single Arm Low 	Boxed	YM	9	51	36W x 10.5D x 22H	1.9	780	932	1,013	1,092	1,175	1,256	1,347	1,439	1,544	1,682	1,846	2,010	2,170	2,336
	Rolled Front	YM	8	51	34W x 10.5D x 22H	1.9	780	932	1,013	1,092	1,175	1,256	1,347	1,439	1,544	1,682	1,846	2,010	2,170	2,336

To Order Select Below

1. Series/Style

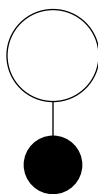

YM9

**Yoom
Boxed**

YM8

**Yoom
Rolled Front**

2. Unit

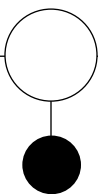

Unit

51 SINGLE ARM LOW

For Modular Single High Arm, refer to Single Back/Single Arm style on [Page 18](#).

3. Seam Options

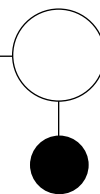

Seam Options

SS SINGLE SEAM ON ALL EDGES

SP PINCH SEAM ON TOP EDGES
SINGLE SEAM ON SIDE EDGES

SW STANDARD WELT CORD ON ALL EDGES **+10% OF COM LIST**

4. Upholstery

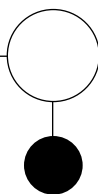

Upholstery

See general information section for details on textile program and COM/COL information.

Yoom Rolled textiles must be cut up the roll. Yoom is designed to have a casual look and feel. It is meant to show wrinkling with most fabrics.

To specify leather, use Yoom Soft found on [page 30](#).

Yoom

MODULAR: PRIVACY SCREEN

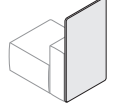
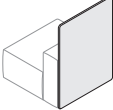
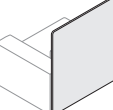
TITLE	SERIES	STYLE	UNIT	DIMENSIONS	Textile Upholstery Grades														
					YDG	COM	A	B	C	D	E	F	G	H	I	J	K	L	M
25 Privacy Screen 	YM	0	61	25W x 1.5D x 45H	2.2	1,091	1,270	1,367	1,461	1,557	1,655	1,760	1,868	1,990	2,152	2,344	2,538	2,728	2,921
34 Privacy Screen 	YM	0	62	34W x 1.5D x 45H	3	1,403	1,642	1,774	1,901	2,031	2,162	2,306	2,448	2,618	2,835	3,097	3,358	3,615	3,875
43 Privacy Screen 	YM	0	63	43W x 1.5D x 45H	3.8	1,715	2,018	2,182	2,340	2,505	2,670	2,851	3,032	3,244	3,517	3,847	4,176	4,499	4,827

To Order Select Below

1. Series/Style

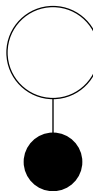

YM0

**Yoom
Privacy Screen**

2. Unit

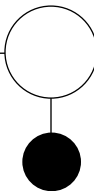

Unit

61	25" PRIVACY SCREEN
62	34" PRIVACY SCREEN
63	43" PRIVACY SCREEN

3. Seam Options

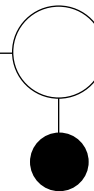

Seam Options

SS	SINGLE SEAM ON ALL EDGES
SP	PINCH SEAM ON TOP EDGES SINGLE SEAM ON SIDE EDGES
SW	STANDARD WELT CORD ON ALL EDGES

**+10% OF
COM LIST**

4. Upholstery

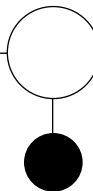

Upholstery

**See general information section
for details on textile program and
COM/COL information.**

Yoom Rolled textiles must be cut up the roll. Yoom is designed to have a casual look and feel. It is meant to show wrinkling with most fabrics.

To specify leather, use Yoom Soft found on [page 30](#).

Yoom

PRE-CONFIGURED: SINGLE CHAIR

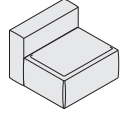
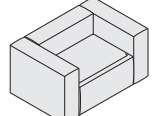
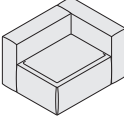
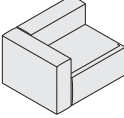
TITLE	SERIES	STYLE	UNIT	DIMENSIONS	YDG	Textile Upholstery Grades														
						COM	A	B	C	D	E	F	G	H	I	J	K	L	M	
Single Chair, Armless 	Boxed	YM	9	113100	36W x 36D x 26H	4.5	2,572	2,956	3,160	3,365	3,570	3,782	4,007	4,237	4,502	4,853	5,267	5,683	6,092	6,510
	Rolled Front	YM	8	113100	36W x 36D x 26H	4.4	2,572	2,937	3,138	3,329	3,526	3,724	3,944	4,158	4,414	4,748	5,143	5,542	5,930	6,323
Single Chair, High Both Arms 	Boxed	YM	9	113131P	56W x 36D x 26H	8.8	4,442	5,184	5,576	5,973	6,370	6,778	7,215	7,657	8,166	8,843	9,643	10,449	11,236	12,044
	Rolled Front	YM	8	113131P	56W x 36D x 26H	8.5	4,442	5,149	5,530	5,897	6,280	6,660	7,086	7,496	7,992	8,636	9,395	10,166	10,916	11,669
Single Chair, High Left Arm 	Boxed	YM	9	113131L	46W x 36D x 26H	6.8	3,507	4,070	4,368	4,669	4,970	5,280	5,611	5,947	6,334	6,848	7,455	8,066	8,664	9,277
	Rolled Front	YM	8	113131L	46W x 36D x 26H	6.4	3,507	4,043	4,334	4,613	4,903	5,192	5,515	5,827	6,203	6,692	7,269	7,854	8,423	8,996
Single Chair, High Right Arm 	Boxed	YM	9	113131R	46W x 36D x 26H	6.8	3,507	4,070	4,368	4,669	4,970	5,280	5,611	5,947	6,334	6,848	7,455	8,066	8,664	9,277
	Rolled Front	YM	8	113131R	46W x 36D x 26H	6.4	3,507	4,043	4,334	4,613	4,903	5,192	5,515	5,827	6,203	6,692	7,269	7,854	8,423	8,996

To Order Select Below

1. Series/Style

- YM9
Yoom Boxed
- YM8
Yoom Rolled Front

2. Unit

- Unit**
 113100 SINGLE CHAIR, ARMLESS
 113131P SINGLE CHAIR, HIGH BOTH ARMS
 113131L SINGLE CHAIR, HIGH LEFT ARM
 113131R SINGLE CHAIR, HIGH RIGHT ARM

3. Seam Options

- Seam Options**
 SS SINGLE SEAM ON ALL EDGES
 SP PINCH SEAM ON TOP EDGES
 SINGLE SEAM ON SIDE EDGES
 SW STANDARD WELT CORD ON ALL EDGES **+10% OF COM LIST**

4. Glides/Casters/Legs

- Glides**
 PG PLASTIC GLIDE
 FG FELT GLIDE
 RG RUBBER GLIDE

Glide Recommendations
 For easier movement, order Plastic Glides for carpet, Felt Glides for hard floors and Rubber Glides for static positioning.

5. Power

- Power**
 Refer to power ordering steps on page 8.
 CH HARD WHEEL CASTER **+93**
 CS SOFT WHEEL CASTER **+93**

 Recommended for mobility in collaborative settings.

Legs
 L1 ROUND METAL LEGS **+162**

 Round Legs increase seating height by 2". Round Legs are available in standard Stylex powder coated painted metal finishes and Polished Aluminum.

6. Options

- Options**
 G GANGING

7. Upholstery

- Upholstery**
 See general information section for details on textile program and COM/COL information.

 Yoom Rolled textiles must be cut up the roll. Yoom is designed to have a casual look and feel. It is meant to show wrinkling with most fabrics.

 To specify leather, use Yoom Soft found on page 30.

Yoom

PRE-CONFIGURED: SINGLE CHAIR

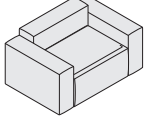
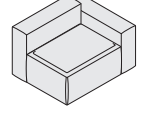
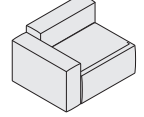
TITLE	SERIES	STYLE	UNIT	DIMENSIONS	YDG	Textile Upholstery Grades														
						COM	A	B	C	D	E	F	G	H	I	J	K	L	M	
Single Chair, Low Both Arms 	Boxed	YM	9	113151P	56W x 36D x 26H	8.3	4,132	4,820	5,186	5,549	5,920	6,294	6,701	7,115	7,590	8,217	8,959	9,703	10,432	11,182
	Rolled Front	YM	8	113151P	56W x 36D x 26H	8	4,132	4,801	5,164	5,513	5,876	6,236	6,638	7,036	7,502	8,112	8,835	9,562	10,270	10,995
Single Chair, Low Left Arm 	Boxed	YM	9	113151L	46W x 36D x 26H	6.4	3,352	3,888	4,173	4,457	4,745	5,038	5,354	5,676	6,046	6,535	7,113	7,693	8,262	8,846
	Rolled Front	YM	8	113151L	46W x 36D x 26H	6.2	3,352	3,869	4,151	4,421	4,701	4,980	5,291	5,597	5,958	6,430	6,989	7,552	8,100	8,659
Single Chair, Low Right Arm 	Boxed	YM	9	113151R	46W x 36D x 26H	6.4	3,352	3,888	4,173	4,457	4,745	5,038	5,354	5,676	6,046	6,535	7,113	7,693	8,262	8,846
	Rolled Front	YM	8	113151R	46W x 36D x 26H	6.2	3,352	3,869	4,151	4,421	4,701	4,980	5,291	5,597	5,958	6,430	6,989	7,552	8,100	8,659

To Order Select Below

1. Series/Style

- YM9
Yoom Boxed
- YM8
Yoom Rolled Front

2. Unit

- Unit
- 113151P SINGLE CHAIR, LOW BOTH ARMS
- 113151L SINGLE CHAIR, LOW LEFT ARM
- 113151R SINGLE CHAIR, LOW RIGHT ARM

3. Seam Options

- Seam Options
- SS SINGLE SEAM ON ALL EDGES
- SP PINCH SEAM ON TOP EDGES
SINGLE SEAM ON SIDE EDGES
- SW STANDARD WELT CORD ON ALL EDGES **+10% OF COM LIST**

4. Glides/Casters/Legs

- Glides
- PG PLASTIC GLIDE
- FG FELT GLIDE
- RG RUBBER GLIDE
- Glide Recommendations**
For easier movement, order Plastic Glides for carpet, Felt Glides for hard floors and Rubber Glides for static positioning.
- Casters
- CH HARD WHEEL CASTER **+93**
- CS SOFT WHEEL CASTER **+93**
- Recommended for mobility in collaborative settings.
- Legs
- L1 ROUND METAL LEGS **+162**
- Round Legs increase seating height by 2". Round Legs are available in standard Stylex powder coated painted metal finishes and Polished Aluminum.

5. Power

- Power
- Refer to power ordering steps on [page 8](#).

6. Options

- Options
- G GANGING

7. Upholstery

- Upholstery
- See [general information section](#) for details on textile program and COM/COL information.
- Yoom Rolled textiles must be cut up the roll. Yoom is designed to have a casual look and feel. It is meant to show wrinkling with most fabrics.
- To specify leather, use Yoom Soft found on [page 30](#).

Yoom

PRE-CONFIGURED: SINGLE FULL CHAIR

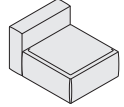
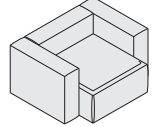
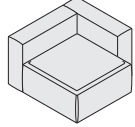
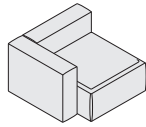
TITLE	SERIES	STYLE	UNIT	DIMENSIONS	YDG	Textile Upholstery Grades														
						COM	A	B	C	D	E	F	G	H	I	J	K	L	M	
Single Full Chair, Armless 	Boxed	YM	9	123100	36W x 45D x 26H	5.5	2,884	3,329	3,569	3,806	4,047	4,288	4,553	4,820	5,129	5,535	6,017	6,502	6,978	7,462
	Rolled Front	YM	8	123100	36W x 45D x 26H	5.3	2,884	3,321	3,557	3,786	4,024	4,258	4,520	4,779	5,086	5,484	5,955	6,431	6,899	7,368
Single Full Chair, High Both Arms 	Boxed	YM	9	123131P	56W x 45D x 26H	9.7	4,754	5,557	5,985	6,414	6,847	7,284	7,761	8,240	8,793	9,525	10,393	11,268	12,122	12,996
	Rolled Front	YM	8	123131P	56W x 45D x 26H	9.4	4,754	5,533	5,949	6,354	6,778	7,194	7,662	8,117	8,664	9,372	10,207	11,055	11,885	12,714
Single Full Chair, High Left Arm 	Boxed	YM	9	123131L	46W x 45D x 26H	7.6	3,819	4,443	4,777	5,110	5,447	5,786	6,157	6,530	6,961	7,530	8,205	8,885	9,550	10,229
	Rolled Front	YM	8	123131L	46W x 45D x 26H	7.3	3,819	4,427	4,753	5,070	5,401	5,726	6,091	6,448	6,875	7,428	8,081	8,743	9,392	10,041
Single Full Chair, High Right Arm 	Boxed	YM	9	123131R	46W x 45D x 26H	7.6	3,819	4,443	4,777	5,110	5,447	5,786	6,157	6,530	6,961	7,530	8,205	8,885	9,550	10,229
	Rolled Front	YM	8	123131R	46W x 45D x 26H	7.3	3,819	4,427	4,753	5,070	5,401	5,726	6,091	6,448	6,875	7,428	8,081	8,743	9,392	10,041

To Order Select Below

1. Series/Style

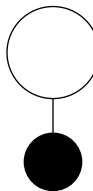

YM9

**Yoom
Boxed**

YM8

**Yoom
Rolled Front**

2. Unit

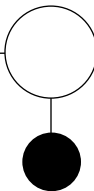

Unit

123100 SINGLE FULL CHAIR, ARMLESS

123131P SINGLE FULL CHAIR, HIGH BOTH ARMS

123131L SINGLE FULL CHAIR, HIGH LEFT ARM

123131R SINGLE FULL CHAIR, HIGH RIGHT ARM

3. Seam Options

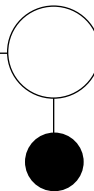

Seam Options

SS SINGLE SEAM ON ALL EDGES

SP PINCH SEAM ON TOP EDGES
SINGLE SEAM ON SIDE EDGES

SW STANDARD WELT CORD ON ALL EDGES **+10% OF COM LIST**

4. Glides/Casters/Legs

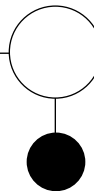

Glides

PG PLASTIC GLIDE

FG FELT GLIDE

RG RUBBER GLIDE

Glide Recommendations
For easier movement, order Plastic Glides for carpet, Felt Glides for hard floors and Rubber Glides for static positioning.

Casters

CH HARD WHEEL CASTER **+93**

CS SOFT WHEEL CASTER **+93**

Recommended for mobility in collaborative settings.

Legs

L1 ROUND METAL LEGS **+162**

Round Legs increase seating height by 2". Round Legs are available in standard Stylex powder coated painted metal finishes and Polished Aluminum.

5. Power

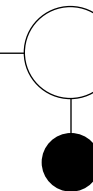

Power

Refer to power ordering steps on [page 8](#).

6. Options

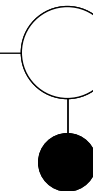

Options

G GANGING

7. Upholstery

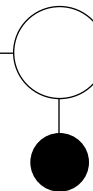

Upholstery

See [general information section](#) for details on textile program and COM/COL information.

Yoom Rolled textiles must be cut up the roll. Yoom is designed to have a casual look and feel. It is meant to show wrinkling with most fabrics.

To specify leather, use Yoom Soft found on [page 30](#).

Yoom

PRE-CONFIGURED: SINGLE FULL CHAIR

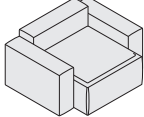
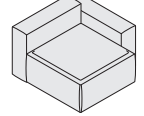
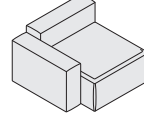
TITLE	SERIES	STYLE	UNIT	DIMENSIONS	YDG	Textile Upholstery Grades														
						COM	A	B	C	D	E	F	G	H	I	J	K	L	M	
Single Full Chair, Low Both Arms 	Boxed	YM	9	123151P	56W x 45D x 26H	9.2	4,444	5,193	5,595	5,990	6,397	6,800	7,247	7,698	8,217	8,899	9,709	10,522	11,318	12,134
	Rolled Front	YM	8	123151P	56W x 45D x 26H	8.8	4,444	5,185	5,583	5,970	6,374	6,770	7,214	7,657	8,174	8,848	9,647	10,451	11,239	12,040
Single Full Chair, Low Left Arm 	Boxed	YM	9	123151L	46W x 45D x 26H	7.3	3,664	4,261	4,582	4,898	5,222	5,544	5,900	6,259	6,673	7,217	7,863	8,512	9,148	9,798
	Rolled Front	YM	8	123151L	46W x 45D x 26H	7	3,664	4,253	4,570	4,878	5,199	5,514	5,867	6,218	6,630	7,166	7,801	8,441	9,069	9,704
Single Full Chair, Low Right Arm 	Boxed	YM	9	123151R	46W x 45D x 26H	7.3	3,664	4,261	4,582	4,898	5,222	5,544	5,900	6,259	6,673	7,217	7,863	8,512	9,148	9,798
	Rolled Front	YM	8	123151R	46W x 45D x 26H	7	3,664	4,253	4,570	4,878	5,199	5,514	5,867	6,218	6,630	7,166	7,801	8,441	9,069	9,704

To Order Select Below

1. Series/Style

- YM9
Yoom Boxed
- YM8
Yoom Rolled Front

2. Unit

- Unit
- 123151P SINGLE FULL CHAIR, LOW BOTH ARMS
- 123151L SINGLE FULL CHAIR, LOW LEFT ARM
- 123151R SINGLE FULL CHAIR, LOW RIGHT ARM

3. Seam Options

- Seam Options
- SS SINGLE SEAM ON ALL EDGES
- SP PINCH SEAM ON TOP EDGES
SINGLE SEAM ON SIDE EDGES
- SW STANDARD WELT CORD ON ALL EDGES **+10% OF COM LIST**

4. Glides/Casters/Legs

- Glides
 - PG PLASTIC GLIDE
 - FG FELT GLIDE
 - RG RUBBER GLIDE
- Glide Recommendations**
For easier movement, order Plastic Glides for carpet, Felt Glides for hard floors and Rubber Glides for static positioning.

5. Power

- Power
 - CH HARD WHEEL CASTER **+93**
 - CS SOFT WHEEL CASTER **+93**
- Recommended for mobility in collaborative settings.
- Legs
 - L1 ROUND METAL LEGS **+162**
- Round Legs increase seating height by 2". Round Legs are available in standard Stylex powder coated painted metal finishes and Polished Aluminum.

6. Options

- Options
- G GANGING

7. Upholstery

- Upholstery
 - See **general information section for details on textile program and COM/COL information.**
- Yoom Rolled textiles must be cut up the roll. Yoom is designed to have a casual look and feel. It is meant to show wrinkling with most fabrics.
- To specify leather, use Yoom Soft found on [page 30](#).

Yoom

PRE-CONFIGURED: DOUBLE CHAIR

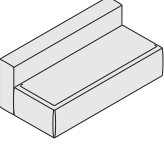
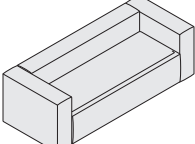
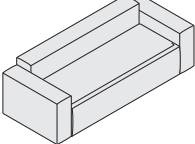
TITLE	SERIES	STYLE	UNIT	DIMENSIONS	YDG	Textile Upholstery Grades														
						COM	A	B	C	D	E	F	G	H	I	J	K	L	M	
Double Chair, Armless 	Boxed	YM	9	143400	70W x 36D x 26H	8.6	4,443	5,155	5,542	5,916	6,304	6,690	7,113	7,538	8,037	8,688	9,461	10,230	10,992	11,769
	Rolled Front	YM	8	143400	70W x 36D x 26H	8.3	4,443	5,122	5,491	5,846	6,211	6,576	6,979	7,387	7,856	8,474	9,209	9,945	10,665	11,400
Double Chair, High Both Arms 	Boxed	YM	9	143431P	90W x 36D x 26H	12.8	6,313	7,383	7,958	8,524	9,104	9,686	10,321	10,958	11,701	12,678	13,837	14,996	16,136	17,303
	Rolled Front	YM	8	143431P	90W x 36D x 26H	12.3	6,313	7,334	7,883	8,414	8,965	9,512	10,121	10,725	11,434	12,362	13,461	14,569	15,651	16,746
Double Chair, Low Both Arms 	Boxed	YM	9	143451P	90W x 36D x 26H	12.2	6,003	7,019	7,568	8,100	8,654	9,202	9,807	10,416	11,125	12,052	13,153	14,250	15,332	16,441
	Rolled Front	YM	8	143451P	90W x 36D x 26H	11.9	6,003	6,986	7,517	8,030	8,561	9,088	9,673	10,265	10,944	11,838	12,901	13,965	15,005	16,072

To Order Select Below

1. Series/Style

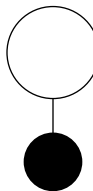

YM9

Yoom Boxed

YM8

Yoom Rolled Front

2. Unit

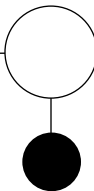

Unit

143400

DOUBLE CHAIR, ARMLESS

143431P

DOUBLE CHAIR, HIGH BOTH ARMS

143451P

DOUBLE CHAIR, LOW BOTH ARMS

3. Seam Options

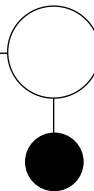

Seam Options

SS

SINGLE SEAM ON ALL EDGES

SP

PINCH SEAM ON TOP EDGES
SINGLE SEAM ON SIDE EDGES

SW

STANDARD WELT CORD ON ALL EDGES

+10% OF COM LIST

4. Glides/Casters/Legs

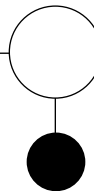

Glides

PG

PLASTIC GLIDE

FG

FELT GLIDE

RG

RUBBER GLIDE

Glide Recommendations

For easier movement, order Plastic Glides for carpet, Felt Glides for hard floors and Rubber Glides for static positioning.

5. Power

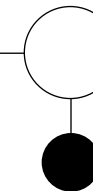

Power

Refer to power ordering steps on [page 8](#).

6. Options

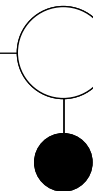

Options

G

GANGING

7. Upholstery

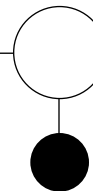

Upholstery

See [general information section](#) for details on textile program and COM/COL information.

Yoom Rolled textiles must be cut up the roll. Yoom is designed to have a casual look and feel. It is meant to show wrinkling with most fabrics.

To specify leather, use Yoom Soft found on [page 30](#).

Yoom

PRE-CONFIGURED: DOUBLE FULL CHAIR

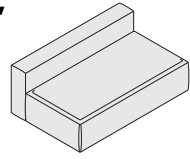
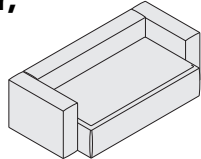
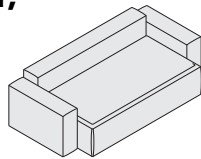
TITLE	SERIES	STYLE	UNIT	DIMENSIONS	YDG	Textile Upholstery Grades														
						COM	A	B	C	D	E	F	G	H	I	J	K	L	M	
Double Full Chair, Armless 	Boxed	YM	9	153400	70W x 45D x 26H	9.7	5,066	5,869	6,303	6,724	7,161	7,597	8,072	8,549	9,111	9,840	10,712	11,580	12,434	13,306
	Rolled Front	YM	8	153400	70W x 45D x 26H	9.4	5,066	5,745	6,114	6,468	6,835	7,201	7,603	8,010	8,480	9,098	9,832	10,569	11,290	12,025
Double Full Chair, High Both Arms 	Boxed	YM	9	153431P	90W x 45D x 26H	13.9	6,936	8,097	8,719	9,332	9,961	10,593	11,280	11,969	12,775	13,830	15,088	16,346	17,578	18,840
	Rolled Front	YM	8	153431P	90W x 45D x 26H	13.5	6,936	7,957	8,506	9,036	9,589	10,137	10,745	11,348	12,058	12,986	14,084	15,193	16,276	17,371
Double Full Chair, Low Both Arms 	Boxed	YM	9	153451P	90W x 45D x 26H	13.3	6,626	7,733	8,329	8,908	9,511	10,109	10,766	11,427	12,199	13,204	14,404	15,600	16,774	17,978
	Rolled Front	YM	8	153451P	90W x 45D x 26H	13	6,626	7,609	8,140	8,652	9,185	9,713	10,297	10,888	11,568	12,462	13,524	14,589	15,630	16,697

To Order Select Below

1. Series/Style

- YM9
Yoom Boxed
- YM8
Yoom Rolled Front

2. Unit

- 153400 DOUBLE FULL CHAIR, ARMLESS
- 153431P DOUBLE FULL CHAIR, HIGH BOTH ARMS
- 153451P DOUBLE FULL CHAIR, LOW BOTH ARMS

3. Seam Options

- SS SINGLE SEAM ON ALL EDGES
- SP PINCH SEAM ON TOP EDGES
SINGLE SEAM ON SIDE EDGES
- SW STANDARD WELT CORD ON ALL EDGES **+10% OF COM LIST**

4. Glides/Casters/Legs

- PG PLASTIC GLIDE
 - FG FELT GLIDE
 - RG RUBBER GLIDE
- Glide Recommendations**
For easier movement, order Plastic Glides for carpet, Felt Glides for hard floors and Rubber Glides for static positioning.
- L1 ROUND METAL LEGS **+162**
- Round Legs increase seating height by 2". Round Legs are available in standard Stylex powder coated painted metal finishes and Polished Aluminum.

5. Power

- Power
Refer to power ordering steps on [page 8](#).

6. Options

- G GANGING

7. Upholstery

- Upholstery
See [general information section](#) for details on textile program and COM/COL information.
- Yoom Rolled textiles must be cut up the roll. Yoom is designed to have a casual look and feel. It is meant to show wrinkling with most fabrics.
- To specify leather, use Yoom Soft found on [page 30](#).

Yoom

PRE-CONFIGURED: CHAISE, CORNER, & SINGLE NARROW

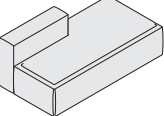
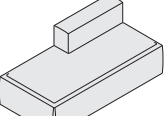
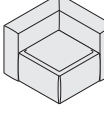
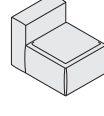
TITLE	SERIES	STYLE	UNIT	DIMENSIONS	Textile Upholstery Grades															
					YDG	COM	A	B	C	D	E	F	G	H	I	J	K	L	M	
Chaise Right w/Back 	Boxed	YM	9	1631	70W x 36D x 26H	7.4	4,286	4,885	5,206	5,521	5,846	6,171	6,524	6,882	7,296	7,842	8,486	9,137	9,772	10,422
	Rolled Front	YM	8	1631	70W x 36D x 26H	7.2	4,286	4,867	5,179	5,482	5,798	6,112	6,459	6,800	7,208	7,737	8,363	8,993	9,612	10,236
Chaise Left w/Back 	Boxed	YM	9	1731	70W x 36D x 26H	7.4	4,286	4,885	5,206	5,521	5,846	6,171	6,524	6,882	7,296	7,842	8,486	9,137	9,772	10,422
	Rolled Front	YM	8	1731	70W x 36D x 26H	7.2	4,286	4,867	5,179	5,482	5,798	6,112	6,459	6,800	7,208	7,737	8,363	8,993	9,612	10,236
Corner Chair 	Boxed	YM	9	1337	36W x 36D x 26H	5	2,729	3,148	3,376	3,596	3,824	4,051	4,300	4,548	4,841	5,222	5,675	6,132	6,577	7,031
Single Narrow Chair 	Boxed	YM	9	1333	27W x 36D x 26H	3.3	2,184	2,450	2,596	2,737	2,881	3,028	3,185	3,344	3,532	3,777	4,064	4,356	4,642	4,930
	Rolled Front	YM	8	1333	27W x 36D x 26H	4	2,184	2,515	2,689	2,863	3,042	3,220	3,419	3,614	3,844	4,149	4,502	4,861	5,215	5,570

To Order Select Below

1. Series/Style

- YM9
Yoom Boxed
- YM8
Yoom Rolled Front

2. Unit

- 1631 CHAISE RIGHT W/BACK
- 1731 CHAISE LEFT W/BACK
- 1337 CORNER CHAIR
- 1333 SINGLE NARROW CHAIR

For a rolled front corner chair, modular pieces **YM913** (boxed single narrow seat) and **YM837** (rolled front corner back) should be used together.

3. Seam Options

- SS SINGLE SEAM ON ALL EDGES
- SP PINCH SEAM ON TOP EDGES
SINGLE SEAM ON SIDE EDGES
- SW STANDARD WELT CORD ON ALL EDGES **+10% OF COM LIST**

4. Glides/Casters/Legs

- PG PLASTIC GLIDE
- FG FELT GLIDE
- RG RUBBER GLIDE

Glide Recommendations
For easier movement, order Plastic Glides for carpet, Felt Glides for hard floors and Rubber Glides for static positioning.

5. Power

- CH HARD WHEEL CASTER **+93**
- CS SOFT WHEEL CASTER **+93**

Not available on chaise. Recommended for mobility in collaborative settings.

Legs

- L1 ROUND METAL LEGS **+162**

Round Legs increase seating height by 2". Round Legs are available in standard Stylex powder coated painted metal finishes and Polished Aluminum.

6. Options

- G GANGING

Power
Refer to power ordering steps on [page 8](#).

7. Upholstery

Upholstery
See [general information section](#) for details on textile program and COM/COL information.

Yoom Rolled textiles must be cut up the roll. Yoom is designed to have a casual look and feel. It is meant to show wrinkling with most fabrics.

To specify leather, use Yoom Soft found on [page 30](#).

Yoom Soft

MODULAR: SEATS

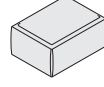
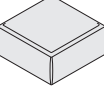
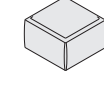
TITLE	SERIES	STYLE	UNIT	DIMENSIONS	COM	COL	Textile Upholstery Grades										Leather Upholstery Grades										
							YDG	SQFT	COM	A	B	C	D	E	F	G	H	I	J	K	L	M	W	X	Y	E1	E2
Single Seat		Boxed	YM	6	11	36.25W x 27.25D x 15H	2.5	36	1,827	2,035	2,148	2,257	2,372	2,482	2,607	2,732	2,879	3,070	3,297	3,520	3,747	3,971	2,878	3,150	4,034	4,399	5,396
		Rolled Front	YM	5	11	36.25W x 27.25D x 15H	2.5	40	1,827	2,025	2,135	2,240	2,348	2,455	2,576	2,695	2,833	3,014	3,230	3,449	3,661	3,877	3,060	3,380	4,414	4,847	6,017
Single Full Seat		Boxed	YM	6	12	36.25W x 36.25D x 15H	3.3	44	2,305	2,576	2,723	2,864	3,013	3,161	3,322	3,485	3,674	3,923	4,218	4,515	4,805	5,100	3,579	3,912	4,984	5,431	6,640
		Rolled Front	YM	5	12	36.25W x 36.25D x 15H	3.3	48	2,305	2,576	2,723	2,864	3,013	3,161	3,322	3,485	3,674	3,923	4,218	4,515	4,805	5,100	3,775	4,158	5,393	5,906	7,300
Single Narrow Seat		Boxed	YM	6	13	36.25W x 36.25D x 15H	1.7	29	1,508	1,645	1,717	1,790	1,863	1,938	2,019	2,099	2,195	2,318	2,466	2,616	2,760	2,908	2,364	2,591	3,306	3,608	4,420
		Rolled Front	YM	5	13	36.25W x 27.25D x 15H	2	32	1,508	1,671	1,761	1,846	1,934	2,023	2,122	2,217	2,333	2,480	2,658	2,836	3,011	3,188	2,463	2,729	3,543	3,883	4,803

To Order Select Below

1. Series/Style

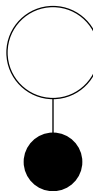

YM6

**Yoom Soft
Boxed**

YM5

**Yoom Soft
Rolled Front**

2. Unit

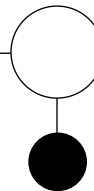

Unit

11 SINGLE SEAT

12 SINGLE FULL SEAT

13 SINGLE NARROW SEAT

3. Seam Options

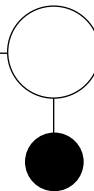

Seam Options

SS SINGLE SEAM ON ALL EDGES

SP PINCH SEAM ON TOP EDGES
SINGLE SEAM ON SIDE EDGES

SW STANDARD WELT CORD
ON ALL EDGES **+10% OF
COM LIST**

4. Glides/Casters/Legs

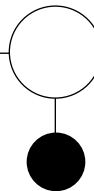

Glides

PG PLASTIC GLIDE

FG FELT GLIDE

RG RUBBER GLIDE

Glide Recommendations
For easier movement, order Plastic
Glides for carpet, Felt Glides for hard
floors and Rubber Glides for static
positioning.

Casters

CH HARD WHEEL CASTER **+93**

CS SOFT WHEEL CASTER **+93**

Recommended for mobility in
collaborative settings.

Legs

L1 ROUND METAL LEGS **+162**

Round Legs increase seating height by 2".
Round Legs are available in standard Stylex
powder coated painted metal finishes and
Polished Aluminum.

5. Power

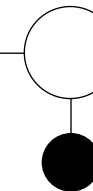

Power

Refer to power
ordering steps
on [page 8](#).

6. Options

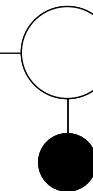

Options

G GANGING

7. Upholstery

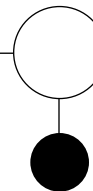

Upholstery

See [general information
section for details on textile
program and COM/COL
information.](#)

Yoom Rolled textiles must be cut up
the roll. Yoom is designed to have a
casual look and feel. It is meant to
show wrinkling with most fabrics.

Yoom Soft

MODULAR: SEATS

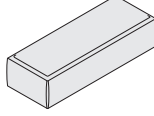
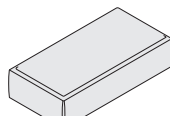
TITLE	SERIES	STYLE	UNIT	DIMENSIONS	COM	COL	Textile Upholstery Grades										Leather Upholstery Grades									
							YDG	SQFT	COM	A	B	COL	C	D	E	F	G	H	I	J	K	L	M	W	X	Y
Double Seat 	Boxed	YM	6	14	70.25W x 27.25D x 15H	4.4	61	3,098	3,460	3,656	3,847	4,044	4,241	4,457	4,673	4,928	5,257	5,651	6,046	6,432	6,828	4,892	5,359	6,865	7,494	9,196
	Rolled Front	YM	5	14	70.25W x 27.25D x 15H	4.3	67	3,098	3,450	3,642	3,828	4,021	4,213	4,424	4,633	4,880	5,203	5,588	5,971	6,351	6,733	5,159	5,699	7,433	8,156	10,111
	Rolled Side	YM	4	14	70.25W x 27.25D x 15H	5.5	67	3,098	3,552	3,797	4,035	4,281	4,526	4,796	5,068	5,385	5,797	6,290	6,783	7,268	7,758	5,159	5,699	7,433	8,156	10,111
Double Full Seat 	Boxed	YM	6	15	70.25W x 36.25D x 15H	5.5	72	4,050	4,502	4,748	4,986	5,235	5,480	5,749	6,020	6,338	6,751	7,243	7,734	8,221	8,713	6,162	6,713	8,492	9,231	11,232
	Rolled Front	YM	5	15	70.25W x 36.25D x 15H	4.3	79	4,050	4,494	4,735	4,967	5,209	5,452	5,718	5,982	6,291	6,697	7,179	7,662	8,137	8,618	6,483	7,118	9,163	10,015	12,322
	Rolled Side	YM	4	15	70.25W x 36.25D x 15H	5.5	79	4,050	4,502	4,748	4,986	5,235	5,480	5,749	6,020	6,338	6,751	7,243	7,734	8,221	8,713	6,483	7,118	9,163	10,015	12,322

To Order Select Below

1. Series/Style

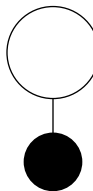

YM6

**Yoom Soft
Boxed**

YM5

**Yoom Soft
Rolled Front**

YM4

**Yoom Soft
Rolled Side**

2. Unit

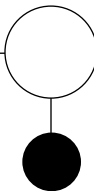

Unit

14 DOUBLE SEAT

15 DOUBLE FULL SEAT

3. Seam Options

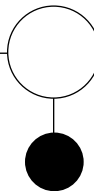

Seam Options

SS SINGLE SEAM ON ALL EDGES

SP PINCH SEAM ON TOP EDGES
SINGLE SEAM ON SIDE EDGES

SW STANDARD WELT CORD ON ALL EDGES **+10% OF COM LIST**

4. Glides/Casters/Legs

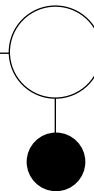

Glides

PG PLASTIC GLIDE

FG FELT GLIDE

RG RUBBER GLIDE

Glide Recommendations
For easier movement, order Plastic Glides for carpet, Felt Glides for hard floors and Rubber Glides for static positioning.

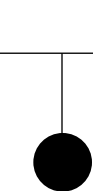

Legs

L1 ROUND METAL LEGS **+162**

Round Legs increase seating height by 2". Round Legs are available in standard Stylex powder coated painted metal finishes and Polished Aluminum.

5. Power

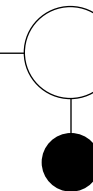

Power

Refer to power ordering steps on [page 8](#).

6. Options

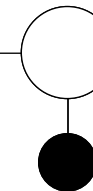

Options

G GANGING

7. Upholstery

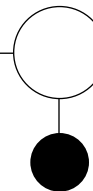

Upholstery

See [general information section](#) for details on textile program and COM/COL information.

Yoom Rolled textiles must be cut up the roll. Yoom is designed to have a casual look and feel. It is meant to show wrinkling with most fabrics.

See [page 9](#) for more information on rolled side specification.

Yoom Soft

MODULAR: SEATS

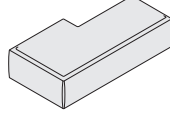
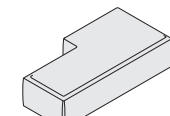
TITLE	SERIES	STYLE	UNIT	DIMENSIONS	COM	COL	Textile Upholstery Grades										Leather Upholstery Grades									
							YDG	SQFT	COM	A	B	C	D	E	F	G	H	I	J	K	L	M	W	X	Y	E1
Chaise Right 	Boxed	YM	6	16	70.25W x 36.25/27.25D x 15H	5.2	64	4,050	4,476	4,708	4,933	5,163	5,394	5,648	5,902	6,202	6,589	7,051	7,514	7,971	8,432	5,936	6,425	8,008	8,667	10,454
	Rolled Front	YM	5	16	70.25W x 36.25/27.25D x 15H	5	70	4,050	4,467	4,694	4,912	5,140	5,366	5,613	5,862	6,157	6,534	6,987	7,439	7,887	8,340	6,202	6,762	8,570	9,323	11,361
	Rolled Side	YM	4	16	70.25W x 36.25/27.25D x 15H	5.5	70	4,050	4,502	4,748	4,986	5,235	5,480	5,749	6,020	6,338	6,751	7,243	7,734	8,221	8,713	6,202	6,762	8,570	9,323	11,361
Chaise Left 	Boxed	YM	6	17	70.25W x 36.25/27.25D x 15H	5.2	64	4,050	4,476	4,708	4,933	5,163	5,394	5,648	5,902	6,202	6,589	7,051	7,514	7,971	8,432	5,936	6,425	8,008	8,667	10,454
	Rolled Front	YM	5	17	70.25W x 36.25/27.25D x 15H	5	70	4,050	4,467	4,694	4,912	5,140	5,366	5,613	5,862	6,157	6,534	6,987	7,439	7,887	8,340	6,202	6,762	8,570	9,323	11,361
	Rolled Side	YM	4	17	70.25W x 36.25/27.25D x 15H	5.5	70	4,050	4,502	4,748	4,986	5,235	5,480	5,749	6,020	6,338	6,751	7,243	7,734	8,221	8,713	6,202	6,762	8,570	9,323	11,361

To Order Select Below

1. Series/Style

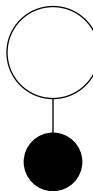

YM6

**Yoom Soft
Boxed**

YM5

**Yoom Soft
Rolled Front**

YM4

**Yoom Soft
Rolled Side**

See [page 9](#) for more information on rolled side specification.

2. Unit

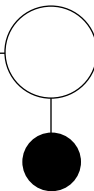

Unit

16 CHAISE RIGHT SEAT

17 CHAISE LEFT SEAT

3. Seam Options

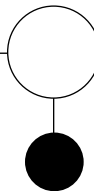

Seam Options

SS SINGLE SEAM ON ALL EDGES

SP PINCH SEAM ON TOP EDGES
SINGLE SEAM ON SIDE EDGES

SW STANDARD WELT CORD ON ALL EDGES **+10% OF COM LIST**

4. Glides/Casters/Legs

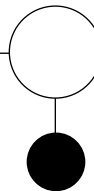

Glides

PG PLASTIC GLIDE

FG FELT GLIDE

RG RUBBER GLIDE

Glide Recommendations
For easier movement, order Plastic Glides for carpet, Felt Glides for hard floors and Rubber Glides for static positioning.

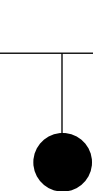

Legs

L1 ROUND METAL LEGS **+162**

Round Legs increase seating height by 2". Round Legs are available in standard Stylex powder coated painted metal finishes and Polished Aluminum.

5. Power

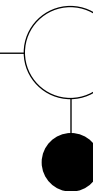

Power

Refer to power ordering steps on [page 8](#).

6. Options

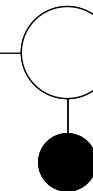

Options

G GANGING

7. Upholstery

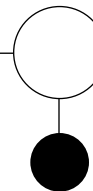

Upholstery

See [general information section](#) for details on textile program and COM/COL information.

Yoom Rolled textiles must be cut up the roll. Yoom is designed to have a casual look and feel. It is meant to show wrinkling with most fabrics.

Yoom Soft

MODULAR: BACKS

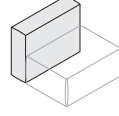
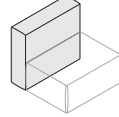
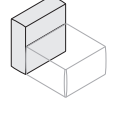
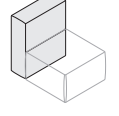
TITLE	SERIES	STYLE	UNIT	DIMENSIONS	COM	COL	Textile Upholstery Grades										Leather Upholstery Grades									
							YDG	SQFT	COM	A	B	C	D	E	F	G	H	I	J	K	L	M	W	X	Y	E1
Single Back/ Single Arm High 	Boxed	YM	6	31	36.25W x 9D x 26H	2.2	30	1,193	1,372	1,471	1,567	1,664	1,764	1,872	1,980	2,106	2,270	2,468	2,667	2,859	3,056	2,059	2,284	3,008	3,313	4,132
	Rolled Front	YM	5	31	36.25W x 9D x 26H	2.1	33	1,193	1,362	1,458	1,546	1,639	1,735	1,838	1,941	2,061	2,217	2,403	2,593	2,776	2,963	2,193	2,453	3,297	3,647	4,596
Single High Back 	Boxed	YM	6	32	36.25W x 9D x 30H	2.5	34	1,310	1,508	1,618	1,724	1,830	1,941	2,060	2,178	2,317	2,499	2,714	2,933	3,144	3,361	2,299	2,556	3,387	3,734	4,671
	Rolled Front	YM	5	32	36.25W x 9D x 30H	2.3	37	1,310	1,502	1,606	1,705	1,808	1,909	2,023	2,139	2,270	2,446	2,650	2,858	3,062	3,270	2,444	2,738	3,688	4,085	5,158
Single Narrow Back 	Boxed	YM	6	33	27.25W x 9D x 26H	1.7	24	1,112	1,249	1,323	1,393	1,467	1,542	1,621	1,704	1,798	1,922	2,070	2,217	2,363	2,511	1,804	1,984	2,567	2,810	3,464
	Rolled Front	YM	5	33	27.25W x 9D x 26H	2.1	26	1,112	1,283	1,377	1,467	1,560	1,656	1,760	1,858	1,981	2,139	2,324	2,512	2,698	2,884	1,902	2,109	2,771	3,048	3,795
Single Narrow High Back 	Boxed	YM	6	38	27.25W x 9D x 30H	1.8	23	1,285	1,427	1,506	1,581	1,658	1,737	1,819	1,905	2,006	2,136	2,288	2,444	2,596	2,751	2,266	2,521	3,346	3,687	4,616
	Rolled Front	YM	5	38	27.25W x 9D x 30H	1.8	23	1,285	1,427	1,506	1,581	1,658	1,737	1,819	1,905	2,006	2,136	2,288	2,444	2,596	2,751	2,266	2,521	3,346	3,687	4,616

To Order Select Below

1. Series/Style

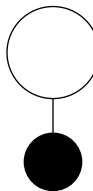

YM6

**Yoom Soft
Boxed**

YM5

**YoomSoft
Rolled Front**

2. Unit

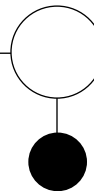

Unit

31 SINGLE BACK/SINGLE ARM HIGH

32 SINGLE HIGH BACK

33 SINGLE NARROW BACK

38 SINGLE NARROW HIGH BACK

3. Seam Options

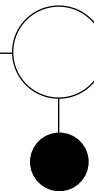

Seam Options

SS SINGLE SEAM ON ALL EDGES

PINCH SEAM ON TOP EDGES
SP SINGLE SEAM ON SIDE EDGES

SW STANDARD WELT CORD ON ALL EDGES **+10% OF COM LIST**

4. Upholstery

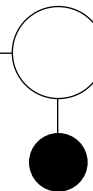

Upholstery

See general information section for details on textile program and COM/COL information.

Yoom Rolled textiles must be cut up the roll. Yoom is designed to have a casual look and feel. It is meant to show wrinkling with most fabrics.

Yoom Soft

MODULAR: BACKS

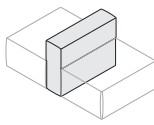
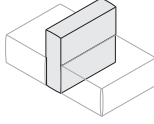
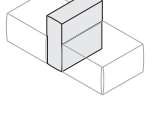
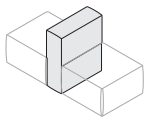
TITLE	SERIES	STYLE	UNIT	DIMENSIONS	COM	COL	Textile Upholstery Grades										Leather Upholstery Grades									
							YDG	SQFT	COM	A	B	C	D	E	F	G	H	I	J	K	L	M	W	X	Y	E1
Single Thin Back to Back 	Boxed	YM	6	39	36.25W x 9D x 26H	2.1	22	1,326	1,493	1,586	1,676	1,767	1,857	1,960	2,061	2,180	2,334	2,517	2,701	2,883	3,063	2,458	2,752	3,704	4,099	5,173
	Rolled Front	YM	5	39	36.25W x 9D x 26H	2.1	22	1,326	1,493	1,586	1,676	1,767	1,857	1,960	2,061	2,180	2,334	2,517	2,701	2,883	3,063	2,458	2,752	3,704	4,099	5,173
Single Thin Back to Back High 	Boxed	YM	6	40	36.25W x 9D x 30H	2.2	24	1,481	1,660	1,754	1,851	1,946	2,045	2,149	2,256	2,378	2,541	2,735	2,930	3,121	3,313	2,615	2,908	3,860	4,256	5,328
	Rolled Front	YM	5	40	36.25W x 9D x 30H	2.2	24	1,481	1,660	1,754	1,851	1,946	2,045	2,149	2,256	2,378	2,541	2,735	2,930	3,121	3,313	2,615	2,908	3,860	4,256	5,328
Single Thin Back to Back Narrow 	Boxed	YM	6	41	27.25W x 9D x 26H	1.6	18	1,326	1,449	1,518	1,582	1,653	1,717	1,794	1,869	1,955	2,068	2,205	2,339	2,473	2,607	2,458	2,752	3,704	4,099	5,173
	Rolled Front	YM	5	41	27.25W x 9D x 26H	1.6	18	1,326	1,449	1,518	1,582	1,653	1,717	1,794	1,869	1,955	2,068	2,205	2,339	2,473	2,607	2,458	2,752	3,704	4,099	5,173
Single Thin Back to Back Narrow High 	Boxed	YM	6	42	27.25W x 9D x 30H	1.6	23	1,481	1,622	1,700	1,775	1,853	1,930	2,014	2,100	2,201	2,332	2,482	2,638	2,790	2,945	2,615	2,908	3,860	4,256	5,328
	Rolled Front	YM	5	42	27.25W x 9D x 30H	1.8	23	1,481	1,622	1,700	1,775	1,853	1,930	2,014	2,100	2,201	2,332	2,482	2,638	2,790	2,945	2,615	2,908	3,860	4,256	5,328

To Order Select Below

1. Series/Style

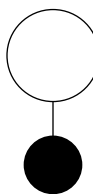

YM6

Yoom Soft Boxed

YM5

Yoom Soft Rolled Front

2. Unit

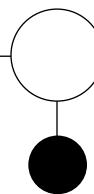

Unit

39 SINGLE THIN BACK TO BACK

40 SINGLE THIN BACK TO BACK HIGH

41 SINGLE THIN BACK TO BACK NARROW

42 SINGLE THIN BACK TO BACK NARROW HIGH

3. Seam Options

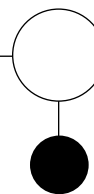

Seam Options

SS SINGLE SEAM ON ALL EDGES

SP PINCH SEAM ON TOP EDGES
SINGLE SEAM ON SIDE EDGES

SW STANDARD WELT CORD ON ALL EDGES **+10% OF COM LIST**

4. Upholstery

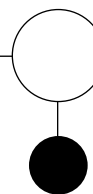

Upholstery

See general information section for details on textile program and COM/COL information.

Yoom Rolled textiles must be cut up the roll. Yoom is designed to have a casual look and feel. It is meant to show wrinkling with most fabrics.

Yoom Soft

MODULAR: BACKS

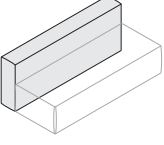
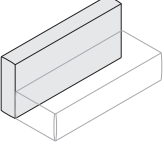
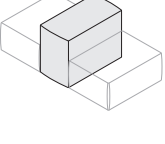
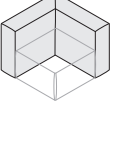
TITLE	SERIES	STYLE	UNIT	DIMENSIONS	COM	COL	Textile Upholstery Grades										Leather Upholstery Grades									
							YDG	SQFT	COM	A	B	C	D	E	F	G	H	I	J	K	L	M	W	X	Y	E1
Double Back 	Boxed	YM	6	34	70.25W x 9D x 26H	4.4	53	2,224	2,584	2,783	2,973	3,170	3,368	3,584	3,799	4,053	4,384	4,778	5,173	5,560	5,954	3,764	4,167	5,464	6,003	7,466
	Rolled Front	YM	5	34	70.25W x 9D x 36H	4.1	57	2,224	2,558	2,742	2,918	3,099	3,281	3,481	3,683	3,918	4,220	4,586	4,952	5,309	5,673	3,984	4,446	5,923	6,540	8,209
Double High Back 	Boxed	YM	6	35	70.25W x 9D x 30H	4.8	60	2,503	2,890	3,101	3,305	3,519	3,732	3,966	4,193	4,468	4,824	5,248	5,671	6,087	6,511	4,265	4,724	6,208	6,826	8,496
	Rolled Front	YM	5	35	70.25W x 9D x 30H	4.7	65	2,503	2,881	3,089	3,291	3,494	3,702	3,928	4,158	4,424	4,769	5,180	5,596	6,003	6,418	4,505	5,028	6,711	7,412	9,312
Single Back to Back 	Boxed	YM	6	36	36.25W x 18D x 26H	3.3	35	1,508	1,780	1,928	2,071	2,218	2,365	2,529	2,689	2,881	3,128	3,425	3,720	4,011	4,306	2,537	2,804	3,667	4,026	5,001
	Rolled Front	YM	5	36	36.25W x 18D x 26H	3.2	38	1,508	1,772	1,916	2,051	2,195	2,338	2,495	2,650	2,836	3,076	3,361	3,647	3,927	4,213	2,663	2,963	3,931	4,334	5,428
Corner Back 	Boxed	YM	6	37	36.25W x 36.25D x 26H	3.5	45	1,905	2,195	2,354	2,506	2,664	2,822	2,994	3,167	3,371	3,633	3,949	4,265	4,574	4,889	3,239	3,585	4,703	5,172	6,430
	Rolled Front	YM	5	37	36.25W x 36.25D x 26H	3.3	50	1,905	2,187	2,339	2,488	2,641	2,792	2,960	3,127	3,323	3,580	3,886	4,190	4,493	4,796	3,433	3,830	5,113	5,648	7,095

To Order Select Below

1. Series/Style

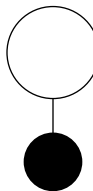

YM6

**Yoom Soft
Boxed**

YM5

**Yoom Soft
Rolled Front**

2. Unit

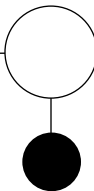

Unit

34 DOUBLE BACK

35 DOUBLE HIGH BACK

36 SINGLE BACK TO BACK

37 CORNER BACK

3. Seam Options

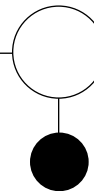

Seam Options

SS SINGLE SEAM ON ALL EDGES

SP PINCH SEAM ON TOP EDGES
SINGLE SEAM ON SIDE EDGES

SW STANDARD WELT CORD ON ALL EDGES **+10% OF COM LIST**

4. Upholstery

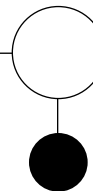

Upholstery

See general information section for details on textile program and COM/COL information.

Yoom Rolled textiles must be cut up the roll. Yoom is designed to have a casual look and feel. It is meant to show wrinkling with most fabrics.

Yoom Soft

MODULAR: ARMS

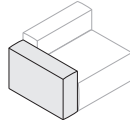
TITLE	SERIES	STYLE	UNIT	DIMENSIONS	COM		Textile Upholstery Grades										Leather Upholstery Grades									
					YDG	COL	COM	A	B	C	D	E	F	G	H	I	J	K	L	M	W	X	Y	E1	E2	
Arm Single Low 	Boxed	YM	6	51	36.25W x 10.375D x 22H	1.9	30	992	1,147	1,231	1,312	1,396	1,478	1,571	1,663	1,772	1,909	2,077	2,244	2,412	2,578	1,860	2,088	2,815	3,123	3,943
	Rolled Front	YM	5	51	36.25W x 10.375D x 22H	1.9	33	992	1,147	1,231	1,312	1,396	1,478	1,571	1,663	1,772	1,909	2,077	2,244	2,412	2,578	1,990	2,253	3,089	3,438	4,384

To Order Select Below

1. Series/Style

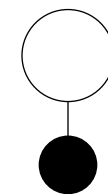

YM6

**Yoom Soft
Boxed**

YM5

**Yoom Soft
Rolled Front**

2. Unit

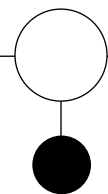

Unit

51 SINGLE ARM LOW

For Modular Single High Arm, refer to Single Back/Single Arm style on [Page 33](#).

3. Seam Options

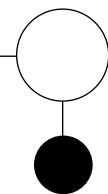

Seam Options

SS SINGLE SEAM ON ALL EDGES

SP PINCH SEAM ON TOP EDGES
SINGLE SEAM ON SIDE EDGES

SW STANDARD WELT CORD ON ALL EDGES **+10% OF COM LIST**

4. Upholstery

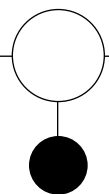

Upholstery

See general information section for details on textile program and COM/COL information.

Yoom Rolled textiles must be cut up the roll. Yoom is designed to have a casual look and feel. It is meant to show wrinkling with most fabrics.

Yoom Soft

PRE-CONFIGURED: SINGLE CHAIR

TITLE	SERIES	STYLE	UNIT	DIMENSIONS	COM	COL	Textile Upholstery Grades															Leather Upholstery Grades				
							YDG	SQFT	COM	A	B	C	D	E	F	G	H	I	J	K	L	M	W	X	Y	E1
Single Chair, Armless	Boxed	YM	6	113100	36.25W x 36.25D x 26H	4.5	65	3,020	3,407	3,619	3,824	4,036	4,246	4,479	4,712	4,985	5,340	5,765	6,187	6,606	7,027	4,937	5,434	7,042	7,712	9,528
								Rolled Front	YM	5	113100	36.25W x 36.25D x 26H	4.4	73	3,020	3,387	3,593	3,786	3,987	4,190	4,414	4,636	4,894	5,231	5,633	6,042
Single Chair, High Both Arms	Boxed	YM	6	113131P	55.25W x 36.25D x 26H	8.8	124	5,406	6,151	6,561	6,958	7,364	7,774	8,223	8,672	9,197	9,880	10,701	11,521	12,324	13,139	9,055	10,002	13,058	14,338	17,792
								Rolled Front	YM	5	113131P	55.25W x 36.25D x 26H	8.5	138	5,406	6,111	6,509	6,878	7,265	7,660	8,090	8,518	9,016	9,665	10,439	11,228
Single Chair, High Left Arm	Boxed	YM	6	113131L	45.75W x 36D x 26H	6.8	95	4,213	4,779	5,090	5,391	5,700	6,010	6,351	6,692	7,091	7,610	8,233	8,854	9,465	10,083	6,996	7,718	10,050	11,025	13,660
								Rolled Front	YM	5	113131L	45.75W x 36D x 26H	6.4	105	4,213	4,749	5,051	5,332	5,626	5,925	6,252	6,577	6,955	7,448	8,036	8,635
Single Chair, High Right Arm	Boxed	YM	6	113131R	45.75W x 36.25D x 26H	6.8	95	4,213	4,779	5,090	5,391	5,700	6,010	6,351	6,692	7,091	7,610	8,233	8,854	9,465	10,083	6,996	7,718	10,050	11,025	13,660
								Rolled Front	YM	5	113131R	45.75W x 36.25D x 26H	6.4	105	4,213	4,749	5,051	5,332	5,626	5,925	6,252	6,577	6,955	7,448	8,036	8,635

To Order Select Below

1. Series/Style

- YM6
Yoom Soft Boxed
- YM5
Yoom Soft Rolled Front

2. Unit

- 113100 SINGLE CHAIR, ARMLESS
- 113131P SINGLE CHAIR, HIGH BOTH ARMS
- 113131L SINGLE CHAIR, HIGH LEFT ARM
- 113131R SINGLE CHAIR, HIGH RIGHT ARM

3. Seam Options

- SS SINGLE SEAM ON ALL EDGES
- SP PINCH SEAM ON TOP EDGES
SINGLE SEAM ON SIDE EDGES
- SW STANDARD WELT CORD ON ALL EDGES **+10% OF COM LIST**

4. Glides/Casters/Legs

- Glides**
 - PG PLASTIC GLIDE
 - FG FELT GLIDE
 - RG RUBBER GLIDE

Glide Recommendations
For easier movement, order Plastic Glides for carpet, Felt Glides for hard floors and Rubber Glides for static positioning.
- Casters**
 - CH HARD WHEEL CASTER **+93**
 - CS SOFT WHEEL CASTER **+93**

Recommended for mobility in collaborative settings.
- Legs**
 - L1 ROUND METAL LEGS **+162**

Round Legs increase seating height by 2". Round Legs are available in standard Stylex powder coated painted metal finishes and Polished Aluminum.

5. Power

- Power**
Refer to power ordering steps on page 8.

6. Options

- Options**
G GANGING

7. Upholstery

- Upholstery**
See general information section for details on textile program and COM/COL information.
- Yoom Rolled textiles must be cut up the roll. Yoom is designed to have a casual look and feel. It is meant to show wrinkling with most fabrics.

Yoom Soft

PRE-CONFIGURED: SINGLE CHAIR

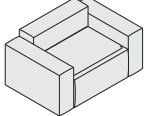
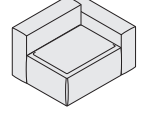
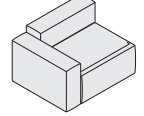
TITLE	SERIES	STYLE	UNIT	DIMENSIONS	COM YDG	COL SQFT	Textile Upholstery Grades													Leather Upholstery Grades						
							COM	A	B	C	D	E	F	G	H	I	J	K	L	M	W	X	Y	E1	E2	
Single Chair, Low Both Arms 	Boxed	YM	6	113151P	55.25W x 36.25D x 26H	8.3	124	5,004	5,701	6,081	6,448	6,828	7,202	7,621	8,038	8,529	9,158	9,919	10,675	11,430	12,183	8,657	9,610	12,672	13,958	17,414
	Rolled Front	YM	5	113151P	55.25W x 36.25D x 26H	8	138	5,004	5,681	6,055	6,410	6,779	7,146	7,556	7,962	8,438	9,049	9,787	10,530	11,261	11,996	9,233	10,339	13,889	15,370	19,381
Single Chair, Low Left Arm 	Boxed	YM	6	113151L	45.75W x 36.25D x 26H	6.4	95	4,012	4,554	4,850	5,136	5,432	5,724	6,050	6,375	6,757	7,249	7,842	8,431	9,018	9,605	6,797	7,522	9,857	10,835	13,471
	Rolled Front	YM	5	113151L	45.75W x 36.25D x 26H	6.2	105	4,012	4,534	4,824	5,098	5,383	5,668	5,985	6,299	6,666	7,140	7,710	8,286	8,849	9,418	7,243	8,086	10,800	11,932	14,997
Single Chair, Low Right Arm 	Boxed	YM	6	113151R	45.75W x 36.25D x 26H	6.4	95	4,012	4,554	4,850	5,136	5,432	5,724	6,050	6,375	6,757	7,249	7,842	8,431	9,018	9,605	6,797	7,522	9,857	10,835	13,471
	Rolled Front	YM	5	113151R	45.75W x 36.25D x 26H	6.2	105	4,012	4,534	4,824	5,098	5,383	5,668	5,985	6,299	6,666	7,140	7,710	8,286	8,849	9,418	7,243	8,086	10,800	11,932	14,997

To Order Select Below

1. Series/Style

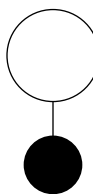

YM6

Yoom Soft Boxed

YM5

Yoom Soft Rolled Front

2. Unit

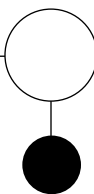

Unit

113151P SINGLE CHAIR, LOW BOTH ARMS

113151L SINGLE CHAIR, LOW LEFT ARM

113151R SINGLE CHAIR, LOW RIGHT ARM

3. Seam Options

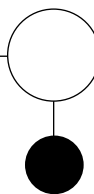

Seam Options

SS SINGLE SEAM ON ALL EDGES

SP PINCH SEAM ON TOP EDGES
SINGLE SEAM ON SIDE EDGES

SW STANDARD WELT CORD ON ALL EDGES **+10% OF COM LIST**

4. Glides/Casters/Legs

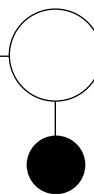

Glides

PG PLASTIC GLIDE

FG FELT GLIDE

RG RUBBER GLIDE

Glide Recommendations
For easier movement, order Plastic Glides for carpet, Felt Glides for hard floors and Rubber Glides for static positioning.

Casters

CH HARD WHEEL CASTER **+93**

CS SOFT WHEEL CASTER **+93**

Recommended for mobility in collaborative settings.

Legs

L1 ROUND METAL LEGS **+162**

Round Legs increase seating height by 2". Round Legs are available in standard Stylex powder coated painted metal finishes and Polished Aluminum.

5. Power

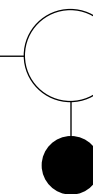

Power

Refer to power ordering steps on page 8.

6. Options

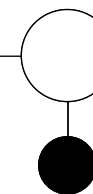

Options

G GANGING

7. Upholstery

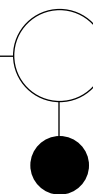

Upholstery

See general information section for details on textile program and COM/COL information.

Yoom Rolled textiles must be cut up the roll. Yoom is designed to have a casual look and feel. It is meant to show wrinkling with most fabrics.

Yoom Soft

PRE-CONFIGURED: SINGLE FULL CHAIR

TITLE	SERIES	STYLE	UNIT	DIMENSIONS	COM	COL	Textile Upholstery Grades															Leather Upholstery Grades				
							YDG	SQFT	COM	A	B	C	D	E	F	G	H	I	J	K	L	M	W	X	Y	E1
Single Full Chair, Armless	Boxed	YM	6	123100	36.25W x 45.25D x 26H	5.5	73	3,498	3,948	4,194	4,431	4,677	4,925	5,194	5,465	5,780	6,193	6,686	7,182	7,664	8,156	5,638	6,196	7,992	8,744	10,772
Single Full Chair, High Both Arms	Boxed	YM	6	123131P	55.25W x 45.25D x 26H	9.7	132	5,884	6,692	7,136	7,565	8,005	8,453	8,938	9,425	9,992	10,733	11,622	12,516	13,382	14,268	9,756	10,764	14,008	15,370	19,036
Single Full Chair, High Left Arm	Boxed	YM	6	123131L	45.75W x 45.25D x 26H	7.4	102	4,691	5,320	5,665	5,998	6,341	6,689	7,066	7,445	7,886	8,463	9,154	9,849	10,523	11,212	7,697	8,480	11,000	12,057	14,904
Single Full Chair, High Right Arm	Boxed	YM	6	123131R	45.75W x 45.25D x 26H	7.4	102	4,691	5,320	5,665	5,998	6,341	6,689	7,066	7,445	7,886	8,463	9,154	9,849	10,523	11,212	7,697	8,480	11,000	12,057	14,904

To Order Select Below

1. Series/Style

- YM6
Yoom Soft Boxed
- YM5
Yoom Soft Rolled Front

2. Unit

- 123100 SINGLE FULL CHAIR, ARMLESS
- 123131P SINGLE FULL CHAIR, HIGH BOTH ARMS
- 123131L SINGLE FULL CHAIR, HIGH LEFT ARM
- 123131R SINGLE FULL CHAIR, HIGH RIGHT ARM

3. Seam Options

- SS SINGLE SEAM ON ALL EDGES
- SP PINCH SEAM ON TOP EDGES
SINGLE SEAM ON SIDE EDGES
- SW STANDARD WELT CORD ON ALL EDGES **+10% OF COM LIST**

4. Glides/Casters/Legs

- Glides**
 - PG PLASTIC GLIDE
 - FG FELT GLIDE
 - RG RUBBER GLIDE

Glide Recommendations
For easier movement, order Plastic Glides for carpet, Felt Glides for hard floors and Rubber Glides for static positioning.
- Casters**
 - CH HARD WHEEL CASTER **+93**
 - CS SOFT WHEEL CASTER **+93**

Recommended for mobility in collaborative settings.
- Legs**
 - L1 ROUND METAL LEGS **+162**

Round Legs increase seating height by 2". Round Legs are available in standard Stylex powder coated painted metal finishes and Polished Aluminum.

5. Power

- Power**
Refer to power ordering steps on page 8.

6. Options

- Options**
 - G GANGING

7. Upholstery

- Upholstery**
See general information section for details on textile program and COM/COL information.
- Yoom Rolled textiles must be cut up the roll. Yoom is designed to have a casual look and feel. It is meant to show wrinkling with most fabrics.

Yoom Soft

PRE-CONFIGURED: SINGLE FULL CHAIR

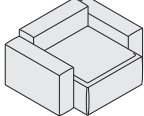
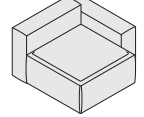
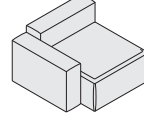
TITLE	SERIES	STYLE	UNIT	DIMENSIONS	COM	COL	Textile Upholstery Grades													Leather Upholstery Grades						
							YDG	SQFT	COM	A	B	COL	C	D	E	F	G	H	I	J	K	L	M	W	X	Y
Single Full Chair, Low Both Arms 	Boxed	YM	6	123151P	55.25W x 45.25D x 26H	9.2	132	5,482	6,242	6,656	7,055	7,469	7,881	8,336	8,791	9,324	10,011	10,840	11,670	12,488	13,312	9,358	10,372	13,622	14,990	18,658
	Rolled Front	YM	5	123151P	55.25W x 45.25D x 26H	8.8	146	5,482	6,232	6,643	7,034	7,444	7,852	8,302	8,752	9,279	9,958	10,775	11,596	12,405	13,219	9,948	11,117	14,868	16,429	20,664
Single Full Chair, Low Left Arm 	Boxed	YM	6	123151L	45.75W x 45.25D x 26H	7.3	103	4,490	5,095	5,425	5,743	6,073	6,403	6,765	7,128	7,552	8,102	8,763	9,426	10,076	10,734	7,498	8,284	10,807	11,867	14,715
	Rolled Front	YM	5	123151L	45.75W x 45.25D x 26H	7	113	4,490	5,085	5,412	5,722	6,048	6,374	6,731	7,089	7,507	8,049	8,698	9,352	9,993	10,641	7,958	8,864	11,779	12,991	16,280
Single Full Chair, Low Right Arm 	Boxed	YM	6	123151R	45.75W x 45.25D x 26H	7.3	103	4,490	5,095	5,425	5,743	6,073	6,403	6,765	7,128	7,552	8,102	8,763	9,426	10,076	10,734	7,498	8,284	10,807	11,867	14,715
	Rolled Front	YM	5	123151R	45.75W x 45.25D x 26H	7	113	4,490	5,085	5,412	5,722	6,048	6,374	6,731	7,089	7,507	8,049	8,698	9,352	9,993	10,641	7,958	8,864	11,779	12,991	16,280

To Order Select Below

1. Series/Style

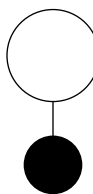

YM6

**Yoom Soft
Boxed**

YM5

**Yoom Soft
Rolled Front**

2. Unit

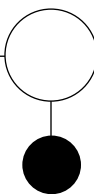

Unit

123151P SINGLE FULL CHAIR,
LOW BOTH ARMS

123151L SINGLE FULL CHAIR,
LOW LEFT ARM

123151R SINGLE FULL CHAIR,
LOW RIGHT ARM

3. Seam Options

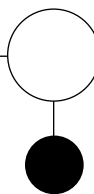

Seam Options

SS SINGLE SEAM ON ALL EDGES

SP PINCH SEAM ON TOP EDGES
SINGLE SEAM ON SIDE EDGES

SW STANDARD WELT CORD
ON ALL EDGES **+10% OF
COM LIST**

4. Glides/Casters/Legs

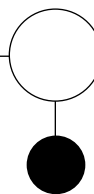

Glides

PG PLASTIC GLIDE

FG FELT GLIDE

RG RUBBER GLIDE

Glide Recommendations
For easier movement, order Plastic
Glides for carpet, Felt Glides for hard
floors and Rubber Glides for static
positioning.

Casters

CH HARD WHEEL CASTER **+93**

CS SOFT WHEEL CASTER **+93**

Recommended for mobility in
collaborative settings.

Legs

L1 ROUND METAL LEGS **+162**

Round Legs increase seating height by 2".
Round Legs are available in standard Stylex
powder coated painted metal finishes and
Polished Aluminum.

5. Power

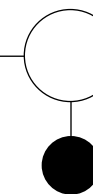

Power

Refer to power
ordering steps
on [page 8](#).

6. Options

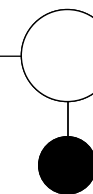

Options

G GANGING

7. Upholstery

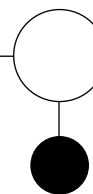

Upholstery

See [general information](#)
section for details on textile
program and COM/COL
information.

Yoom Rolled textiles must be cut up
the roll. Yoom is designed to have a
casual look and feel. It is meant to
show wrinkling with most fabrics.

Yoom Soft

PRE-CONFIGURED: DOUBLE CHAIR

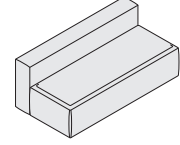
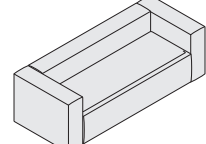
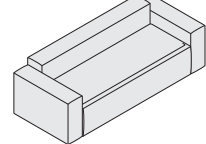
TITLE	SERIES	STYLE	UNIT	DIMENSIONS	COM YDG	COL SQFT	Textile Upholstery Grades										Leather Upholstery Grades									
							COM	A	B	C	D	E	F	G	H	I	J	K	L	M	W	X	Y	E1	E2	
Double Chair, Armless 	Boxed	YM	6	143400	70.25W x 36.25D x 26H	8.6	114	5,322	6,044	6,439	6,820	7,214	7,609	8,041	8,472	8,981	9,641	10,429	11,219	11,992	12,782	8,656	9,526	12,329	13,497	16,662
	Rolled Front	YM	5	143400	70.25W x 36.25D x 26H	8.3	125	5,322	6,008	6,384	6,746	7,120	7,494	7,905	8,316	8,798	9,423	10,174	10,923	11,660	12,406	9,143	10,145	13,356	14,696	18,320
Double Chair, High Both Arms 	Boxed	YM	6	143431P	89.25W x 36.25D x 26H	12.8	173	7,708	8,788	9,381	9,954	10,542	11,137	11,785	12,432	13,193	14,181	15,365	16,553	17,710	18,894	12,774	14,094	18,345	20,123	24,926
	Rolled Front	YM	5	143431P	89.25W x 36.25D x 26H	12.3	190	7,708	8,732	9,300	9,838	10,398	10,964	11,581	12,198	12,920	13,857	14,980	16,109	17,212	18,332	13,529	15,051	19,950	21,990	27,512
Double Chair, Low Both Arms 	Boxed	YM	6	143451P	89.25W x 36.25D x 26H	12.2	173	7,306	8,338	8,901	9,444	10,006	10,565	11,183	11,798	12,525	13,459	14,583	15,707	16,816	17,938	12,376	13,702	17,959	19,743	24,548
	Rolled Front	YM	5	143451P	89.25W x 36.25D x 26H	11.9	190	7,306	8,302	8,846	9,370	9,912	10,450	11,047	11,642	12,342	13,241	14,328	15,411	16,484	17,562	13,123	14,651	19,534	21,572	27,088

To Order Select Below

1. Series/Style

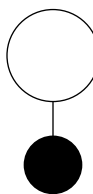

YM6

Yoom Soft Boxed

YM5

Yoom Soft Rolled Front

2. Unit

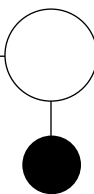

Unit

143400

DOUBLE CHAIR, ARMLESS

143431P

DOUBLE CHAIR, HIGH BOTH ARMS

143451P

DOUBLE CHAIR, LOW BOTH ARMS

3. Seam Options

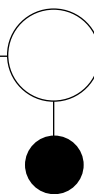

Seam Options

SS

SINGLE SEAM ON ALL EDGES

SP

PINCH SEAM ON TOP EDGES
SINGLE SEAM ON SIDE EDGES

SW

STANDARD WELT CORD ON ALL EDGES

+10% OF COM LIST

4. Glides/Casters/Legs

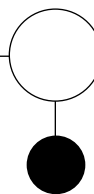

Glides

PG

PLASTIC GLIDE

FG

FELT GLIDE

RG

RUBBER GLIDE

Glide Recommendations

For easier movement, order Plastic Glides for carpet, Felt Glides for hard floors and Rubber Glides for static positioning.

5. Power

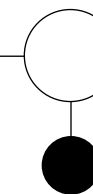

Power

Refer to power ordering steps on [page 8](#).

6. Options

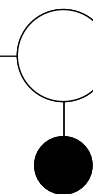

Options

G

GANGING

7. Upholstery

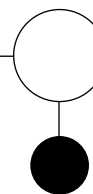

Upholstery

See [general information section](#) for details on textile program and COM/COL information.

Yoom Rolled textiles must be cut up the roll. Yoom is designed to have a casual look and feel. It is meant to show wrinkling with most fabrics.

Yoom Soft

PRE-CONFIGURED: DOUBLE FULL CHAIR

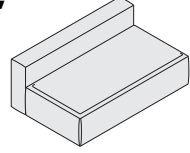
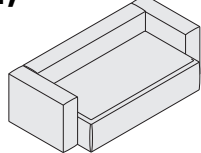
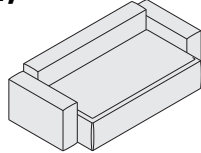
TITLE	SERIES	STYLE	UNIT	DIMENSIONS	COM	COL	Textile Upholstery Grades										Leather Upholstery Grades									
							YDG	SQFT	COM	A	B	C	D	E	F	G	H	I	J	K	L	M	W	X	Y	E1
Double Full Chair, Armless 	Boxed	YM	6	153400	70.25W x 45.25D x 26H	9.7	125	6,274	7,086	7,531	7,959	8,405	8,848	9,333	9,819	10,391	11,135	12,021	12,907	13,781	14,667	9,926	10,880	13,956	15,234	18,698
	Rolled Front	YM	5	153400	70.25W x 45.25D x 26H	9.4	137	6,274	7,052	7,477	7,885	8,308	8,733	9,199	9,665	10,209	10,917	11,765	12,614	13,446	14,291	10,467	11,564	15,086	16,555	20,531
Double Full Chair, High Both Arms 	Boxed	YM	6	153431P	89.25W x 45.25D x 26H	13.9	184	8,660	9,830	10,473	11,093	11,733	12,376	13,077	13,779	14,603	15,675	16,957	18,241	19,499	20,779	14,044	15,448	19,972	21,860	26,962
	Rolled Front	YM	5	153431P	89.25W x 45.25D x 26H	13.5	202	8,660	9,776	10,393	10,977	11,586	12,203	12,875	13,547	14,331	15,351	16,571	17,800	18,998	20,217	14,853	16,470	21,680	23,849	29,723
Double Full Chair, Low Both Arms 	Boxed	YM	6	153451P	89.25W x 45.25D x 26H	13.3	184	8,258	9,380	9,993	10,583	11,197	11,804	12,475	13,145	13,935	14,953	16,175	17,395	18,605	19,823	13,646	15,056	19,586	21,480	26,584
	Rolled Front	YM	5	153451P	89.25W x 45.25D x 26H	13	202	8,258	9,346	9,939	10,509	11,100	11,689	12,341	12,991	13,753	14,735	15,919	17,102	18,270	19,447	14,447	16,070	21,264	23,431	29,299

To Order Select Below

1. Series/Style

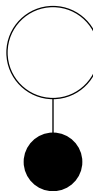

YM6

**Yoom Soft
Boxed**

YM5

**Yoom Soft
Rolled Front**

2. Unit

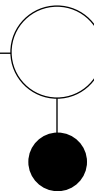

Unit

153400 DOUBLE FULL CHAIR, ARMLESS

153431P DOUBLE FULL CHAIR, HIGH BOTH ARMS

153451P DOUBLE FULL CHAIR, LOW BOTH ARMS

3. Seam Options

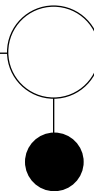

Seam Options

SS SINGLE SEAM ON ALL EDGES

SP PINCH SEAM ON TOP EDGES
SINGLE SEAM ON SIDE EDGES

SW STANDARD WELT CORD ON ALL EDGES **+10% OF COM LIST**

4. Glides/Casters/Legs

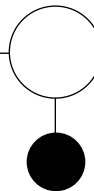

Glides

PG PLASTIC GLIDE

FG FELT GLIDE

RG RUBBER GLIDE

Glide Recommendations
For easier movement, order Plastic Glides for carpet, Felt Glides for hard floors and Rubber Glides for static positioning.

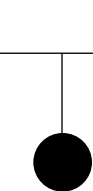

Legs

L1 ROUND METAL LEGS **+162**

Round Legs increase seating height by 2". Round Legs are available in standard Stylex powder coated painted metal finishes and Polished Aluminum.

5. Power

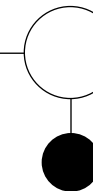

Power

Refer to power ordering steps on [page 8](#).

6. Options

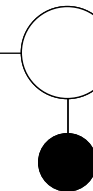

Options

G GANGING

7. Upholstery

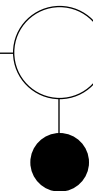

Upholstery

See [general information section](#) for details on textile program and COM/COL information.

Yoom Rolled textiles must be cut up the roll. Yoom is designed to have a casual look and feel. It is meant to show wrinkling with most fabrics.

Yoom Soft

PRE-CONFIGURED: CHAISE, CORNER, & SINGLE NARROW

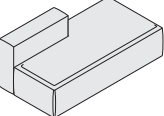
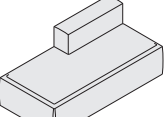
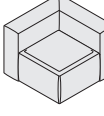
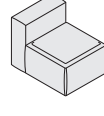
TITLE	SERIES	STYLE	UNIT	DIMENSIONS	COM	COL	Textile Upholstery Grades															Leather Upholstery Grades				
							YDG	SQFT	COM	A	B	C	D	E	F	G	H	I	J	K	L	M	W	X	Y	E1
Chaise Right w/Back 	Boxed	YM	6	1631	70.25W x 36.25D x 26H	7.4	94	5,243	5,848	6,179	6,500	6,827	7,158	7,520	7,882	8,308	8,859	9,519	10,181	10,830	11,488	7,995	8,709	11,016	11,980	14,586
	Rolled Front	YM	5	1631	70.25W x 36.25D x 26H	7.2	103	5,243	5,829	6,152	6,458	6,779	7,101	7,451	7,803	8,218	8,751	9,390	10,032	10,663	11,303	8,395	9,215	11,867	12,970	15,957
Chaise Left w/Back 	Boxed	YM	6	1731	70.25W x 36.25D x 26H	7.4	94	5,243	5,848	6,179	6,500	6,827	7,158	7,520	7,882	8,308	8,859	9,519	10,181	10,830	11,488	7,995	8,709	11,016	11,980	14,586
	Rolled Front	YM	5	1731	70.25W x 36.25D x 26H	7.2	103	5,243	5,829	6,152	6,458	6,779	7,101	7,451	7,803	8,218	8,751	9,390	10,032	10,663	11,303	8,395	9,215	11,867	12,970	15,957
Corner Chair 	Boxed	YM	6	1337	36.25W x 36.25D x 26H	5	75	3,413	3,840	4,071	4,296	4,527	4,760	5,013	5,266	5,566	5,951	6,415	6,881	7,334	7,797	5,603	6,176	8,009	8,780	10,850
Single Narrow Chair 	Boxed	YM	6	1333	27.25W x 36.25D x 26H	3.3	53	2,620	2,894	3,040	3,183	3,330	3,480	3,640	3,803	3,993	4,240	4,536	4,833	5,123	5,419	4,168	4,575	5,873	6,418	7,884
	Rolled Front	YM	5	1333	27.25W x 36.25D x 26H	4	57	2,620	2,954	3,138	3,313	3,494	3,679	3,882	4,075	4,314	4,619	4,982	5,348	5,709	6,072	4,365	4,838	6,314	6,931	8,598

To Order Select Below

1. Series/Style

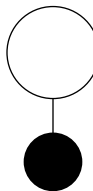

YM6

**Yoom
Boxed**

YM5

**Yoom
Rolled Front**

2. Unit

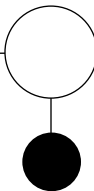

Unit

1631 CHAISE RIGHT W/BACK

1731 CHAISE LEFT W/BACK

1337 CORNER CHAIR

1333 SINGLE NARROW CHAIR

For a rolled front corner chair, modular pieces **YM913** (boxed single narrow seat) and **YM837** (rolled front corner back) should be used together.

3. Seam Options

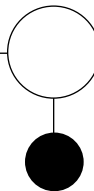

Seam Options

SS SINGLE SEAM ON ALL EDGES

SP PINCH SEAM ON TOP EDGES
SINGLE SEAM ON SIDE EDGES

SW STANDARD WELT CORD ON ALL EDGES **+10% OF COM LIST**

4. Glides/Casters/Legs

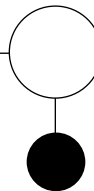

Glides

PG PLASTIC GLIDE

FG FELT GLIDE

RG RUBBER GLIDE

Glide Recommendations
For easier movement, order Plastic Glides for carpet, Felt Glides for hard floors and Rubber Glides for static positioning.

Casters

CH HARD WHEEL CASTER **+93**

CS SOFT WHEEL CASTER **+93**

Not available on chaise. Recommended for mobility in collaborative settings.

Legs

L1 ROUND METAL LEGS **+162**

Round Legs increase seating height by 2". Round Legs are available in standard Stylex powder coated painted metal finishes and Polished Aluminum.

5. Power

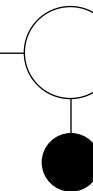

Power

Refer to power ordering steps on page 8.

6. Options

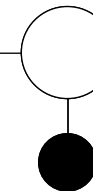

Options

G GANGING

7. Upholstery

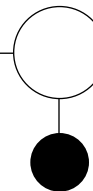

Upholstery

See general information section for details on textile program and COM/COL information.

Yoom Rolled textiles must be cut up the roll. Yoom is designed to have a casual look and feel. It is meant to show wrinkling with most fabrics.