

stylex

Share

PRICE LIST

Effective November 01, 2024

General Information

STYLEX PRICE LIST

GENERAL INFORMATION

Terms

Net 30 days from date of invoice,
F. O. B . Delanco, New Jersey.

Damaged Shipments

All Stylex products are carefully inspected before they are packed in sturdy cartons designed to satisfy shipping requirements. Stylex is not responsible for damage in shipment. The transportation company assumes responsibility for delivering products to you in good condition when the bill of lading is signed. You protect yourself by refusing shipments showing damage or shortage until transportation company has noted on the delivery sheet the extent of damage or shortage. Concealed damage should be reported to the carrier as soon as discovered, but no later than 5 days after receiving shipment.

Return/Restocking Policy

Return shipments will not be accepted unless specifically authorized by Stylex in writing. The Return Authorization number should be clearly marked on the carton. The customer returning Stylex products is responsible for return shipping costs. Merchandise must be returned unused. Returned merchandise is subject to a 35% restocking fee.

Special Products

Modifications to standard products will be considered for large runs. Contact factory for price quotations.

Design Changes

In keeping with modern manufacturing advances, Stylex reserves the right to incorporate minor modifications and design changes in products without notice.

Cancellation/Change Order Policy

Regarding requests for order cancellation and/or order modification, please be advised that no charges will be applied before production, unless inventory has been specifically requisitioned to fulfill your order. Once orders proceed to the production phase, they cannot be altered or canceled under any circumstances. All requests for order cancellations or order changes must be submitted in writing and will only be considered valid upon approval by Stylex.

WARRANTY

Except as provided below, Stylex warrants exclusively to the original Purchaser of our product that all parts, under normal use and service, will be free from defects in workmanship and material for a period of ten (10) years from the date of purchase. "Normal use and service" means that the product will be used in a typical office environment for 40-45 hours per week.

This warranty is subject to the following limitations, exclusions and provisions:

Limitations involving materials and components:

Wood components of plywood stacking chairs
(such as Brooks and Welcome)
5 years

Upholstery

(including mesh used for Click, F4, Insight, and Zephyr Mesh)
3 years

SAVA Mesh

10 years

Pneumatic Cylinders

3 years

COM Upholstery

No warranty
Stylex makes every effort to ensure that the COM Upholstery it approves is suitable for the intended use. Nevertheless, we will not warrant, and assume no responsibility for, the durability or tailoring quality of any COM or COL . If you have any concerns about the ultimate appearance of any covering, please order an upholstered sample.

Painted Stack Chair Frames

No Warranty
We will not warrant the finish of painted stack chair frames against damage from stacking. Please order chrome frames for chairs that will be stacked.

Felt Glides

No warranty
Due to the different surfaces on which felt glides may be used, we cannot warrant their durability over time.

If this product fails during normal use and service within the applicable warranty period (other than through normal wear and tear), please submit a warranty claim at stylexdesign.com/warranty-claim/. Quantity, model details, description of issue, and Stylex certified labels are required for submission. PLEASE DO NOT RETURN PARTS OR THE PRODUCT TO STYLEX UNLESS INSTRUCTED TO DO SO BY STYLEX. Stylex will, at its discretion, either repair or replace the defective product or part at no cost. Labor requests must receive approval and will be authorized on a case-by-case basis. We will only reimburse for labor costs directly incurred, excluding any travel-related expenses. Purchaser may be required (at the option of Stylex) to return to Stylex at Purchaser's expense any defective part with all freight or shipping charges prepaid. The foregoing warranty shall be void if the product has been altered or repaired (other than by Stylex). The warranty does not cover damage to the product caused by accident, neglect, misuse, abuse, modification to the product by anyone other than Stylex or damage caused by use of the product for a purpose other than that for which it was designed. This warranty extends only to the original Purchaser of the product.

No Other Warranties

This warranty is in lieu of all other warranties, expressed or implied, including, but not limited to, implied warranties of merchantability and fitness for a particular purpose. The rights and remedies provided herein are the exclusive rights and remedies of the original purchaser of the product.

No Liability For Damages

In no event shall Stylex or its suppliers be responsible or liable for any special, indirect, consequential, or incidental damages. In no event shall the liability of Stylex exceed the actual purchase price paid to Stylex for the product.

Out of Warranty Products

For all products no longer covered by our warranty, please refer to our Design for Durability and Upgradability Policy. Contact your Account Manager if you would like to purchase any replaceable components to further extend the life of any Stylex seating product. This warranty applies to all Stylex products purchased on April 13, 2018, and thereafter.

PRODUCT TAKE BACK PROGRAM

In order to be good stewards of our products, Stylex offers a pathway towards a Product Take Back Program as a more viable solution to the end of our products' originally intended life.

Stylex supports the sustainable programs of ANEW and offers their added value to our clients through a comprehensive take-back solution for surplus office furniture and materials of any kind, in any condition. ANEW is a 501(c)(3) non-profit organization that exists to provide companies with smart, cost effective alternatives for their surplus furniture and other items with the priority of matching it to non- profits, public agencies and the underserved, within the local community of the project site. Corporate Social Responsibility is raised while the impact on the environment is lowered by diverting products and materials otherwise destined for landfill.

Stylex is proud to offer ANEW to customers dedicated to strengthening their community network by repurposing their furniture, fixtures and architectural materials to those in need. In 2014, Stylex committed to making this relationship a part of our strategic sales strategy. Visit www.anewfound.org to find out more.

To initiate a Product Take Back strategy through ANEW, contact Stylex Account Management at 800-257-5742.

For other end of life recovery options, please see our Product Disassembly Instructions and End of Life Recovery Options documents available on our website in the resources section of each product in our line.

FREIGHT PROGRAM

Freight charges will be calculated as a percentage of the net product price and added to the invoice at the time of shipment. The continental United States has been divided into three zones. Please use the map below to determine freight charges for the product's destination. Minimum freight charge is \$250. Please let us know if you will be shipping to a residential address or require inside delivery as this requires an additional fee. Also please note we need to be made aware if a liftgate is required prior to delivery. If any requests are made at the time of delivery, applicable charges will apply.

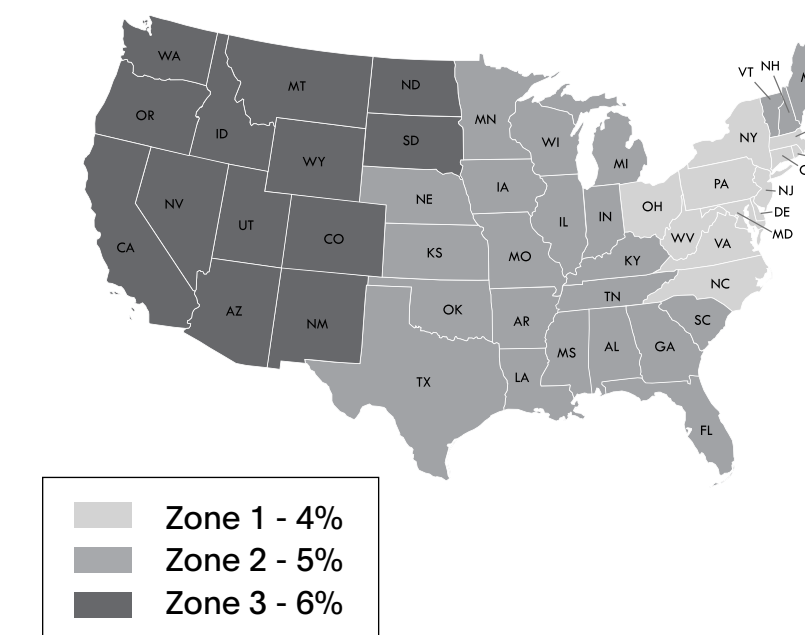

ZONE 1 - 4%

Connecticut
Delaware
New York
New Jersey
Maryland
Massachusetts
North Carolina
Ohio
Pennsylvania
Rhode Island
Virginia
Washington D.C.
West Virginia

ZONE 2 - 5%

Alabama
Arkansas
Canada, Ontario
Canada, Quebec
Florida
Georgia
Iowa
Illinois
Indiana
Kansas
Kentucky
Louisiana
Nebraska
New Hampshire
Oklahoma
Maine
Michigan
Minnesota
Missouri
Mississippi
South Carolina
Tennessee
Texas
Vermont
Wisconsin

ZONE 3 - 6%

Arizona
California
Colorado
Idaho
Montana
Nevada
New Mexico
North Dakota
Oregon
South Dakota
Utah
Washington
Wyoming

Quote Per Project
Alaska
Hawaii
Canada
(outside Ontario & Quebec)
Mexico

General Information

STYLEX PRICE LIST

TEXTILE PARTNERS & APPROVALS

Textile Partners

To customize your furniture performance needs and design vision, Stylex offers a wide selection of in-graded leathers and textiles from Grades A through Y. We've partnered with leading manufacturers on the options, focusing on color, price, durability, and construction. To view our partners and explore our digital carded program with broadly approved textiles, visit [this page](#). We stand by these textiles: They're tried and tested, and will effortlessly fit into any design aesthetic.

Textile Approvals

All textiles must be approved for the product you are specifying. For the related approved textile lists, visit [this page](#).

CAL 117 AND 133 COMPLIANCE

CAL 117-2013

CAL 117-2013 compliance is a requirement for all textiles applied on our seating products. All Stylex seating products meet this standard.

CAL 133

Most Stylex seating can be ordered to meet the requirements of CAL 133. When ordering, simply specify "CAL 133 compliance required". The upcharge for this option is \$54 list per yard. Please refer to the COM yardage of each model to determine the number of yards required. We do frequently require full-scale burn tests in order to certify CAL 133 before an order will be accepted. Such burn tests may increase normal lead times and do carry additional charges. Please contact your Stylex account manager for details.

CUSTOMER'S OWN MATERIAL/LEATHER

Customer's own material (COM) and customer's own leather (COL) will generally be upholstered at the price designated in each product's price list. Please be advised, however, that we specifically reserve the right to charge a higher price when we determine that special circumstances, such as unusual repeats or challenging materials, present themselves. All orders for custom coverings must be approved by Stylex before they will be accepted for production. To submit proposed textile for approval, please use the COM form [here](#).

Special Note:

We assume no responsibility for the durability or tailoring quality of any COM or COL. Directional covers in particular may not meet your satisfaction due to the design of certain products. Please be advised that COM and COL orders are not subject to return. If you have doubts about the ultimate appearance of certain coverings, please order a sample done with that specific COM or COL. In addition, while we inspect fabrics for mill imperfections, some are difficult to recognize. We cannot be responsible for defects, color inaccuracies, dye lot variations, or other flaws.

Under no circumstances will we be responsible for COM shortages, flaws, or other such problems. Finally, it is not our responsibility to police the receipt of COM's in order to meet delivery deadlines, and we assume our customers are aware of any undue delay in the shipment of their COM fabrics.

COM fabric and COL leather should be sent prepaid to: Stylex

**Attn: COM/COL - [Your Stylex PO #]
740 Coopertown Road
Delanco, NJ 08075**

All COM/COL sent to Stylex must be accompanied with a packing list which indicates the dealers' name, Stylex corresponding PO number, sales order number, COM/COL supplier name, textile pattern, colorway and shipped quantity. Stylex requires COM to be sent in as continuous yardage in the same dielot.

Yardage requirements shown in the price list are based on non-directional goods of 54" width. Fabrics less than 54" wide or those requiring matching (stripes, prints, or large patterned designs) call for additional yardage. We will be happy to supply yardage requirements for large quantities where economies may be realized.

Add the following yardage for stripes, plaids, or patterns with repeats:

Fabric Width	Plain Fabric	2-14" Repeat	15-24" Repeat	25-27" Repeat	28-36" Repeat
54"	0%	10%	15%	20%	25%
50"	10%	20%	25%	30%	35%
48"	15%	25%	30%	35%	40%
45"	40%	50%	55%	60%	65%
36"	50%	60%	65%	70%	75%

COM/COL FORM

To avoid delay in processing COM orders we request that you submit a sample of your COM textile stapled to this form which can be downloaded [here](#). If a textile has a stripe or design, the size of the repeat should be indicated. Please indicate the textile supplier's name, textile number, and color. Also indicate the Stylex product on which the textile will be used. If a certain direction of application is required, please ensure that information is communicated directly to your Stylex account manager.

The fabric supplier must indicate on his shipping labels the dealer name and purchase order number as well as the Stylex model number.

Please Note:

No order may be entered into production or have a shipping date assigned until all related COM is received at the factory.



CENTER OF STRIPE OR DESIGN

TOP OF CHAIR	TOP OF CHAIR
--------------	--------------

1. Size of Repeat

2. Textile Supplier

3. Textile Number

4. Color

5. Stylex Product

Share

Contents

<hr/>		<hr/>		<hr/>	
COLORS, MATERIALS, AND FINISHES	5	CHAIR	11	END CAP: SINGLE NARROW	46
STATEMENT OF LINE	6	CHAIR: CORNER	20	KNEE WALL	51
OPTIONS AND ACCESSORIES	7	CHAIR: CURVED	26	ARM	53
DIMENSIONS	8	BENCH	38	ROUND OTTOMAN	54
IDEA STARTERS	9	BENCH: CORNER	41	ACCESSORIES	55
HOW TO ORDER	10	BENCH: CURVED	42		
<hr/>		<hr/>		<hr/>	

CLICK THE TITLES ABOVE TO NAVIGATE THROUGH THE DOCUMENT
PRODUCT HEADERS ON SUBSEQUENT PAGES LINK BACK TO THIS PAGE

Share

COLORS, MATERIALS, AND FINISHES

POWDER COATED PAINTED METAL

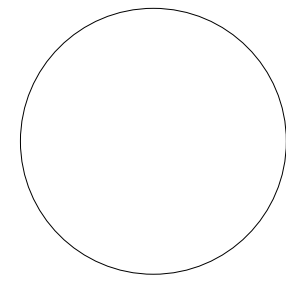

MILK
(MK)

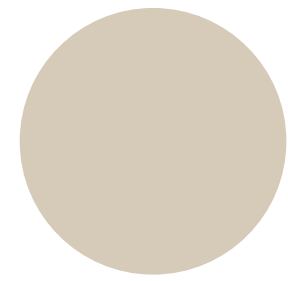

SAND
(SD)

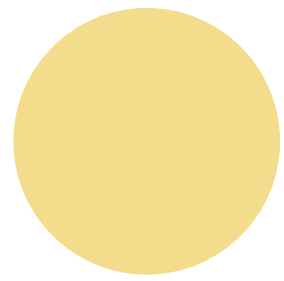

PALE YELLOW
(PY)

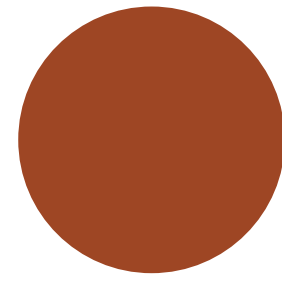

TERRACOTTA
(TC)

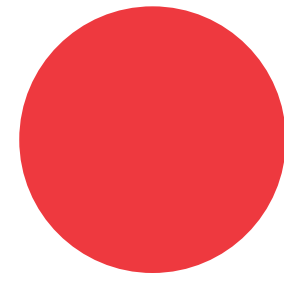

LIPSTICK RED
(LR)

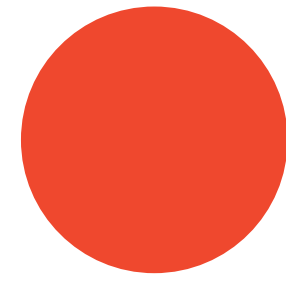

RED ORANGE
(RO)

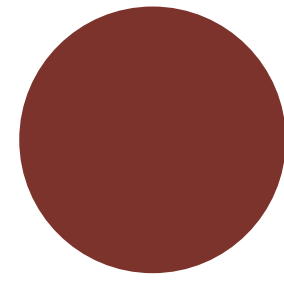

RUSTY RED
(RR)

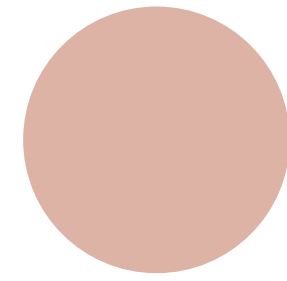

DUSTY PINK
(DP)



LIGHT PISTACHIO
(LP)

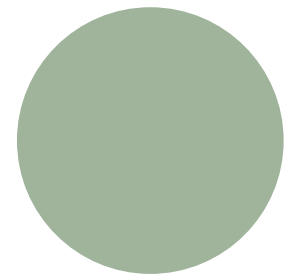

MEADOW GREEN
(MG)

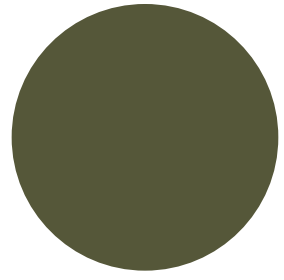

DARK SAGE
(DG)

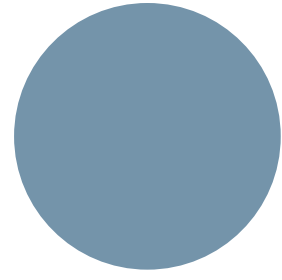

SOFT BLUE
(SB)

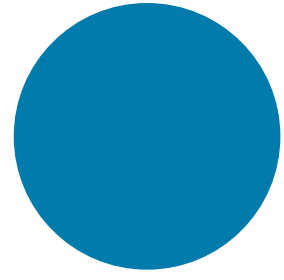

BLUE
(BL)

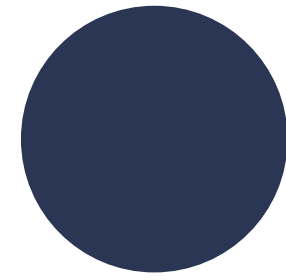

MIDNIGHT BLUE
(MB)



LILAC GRAY
(LL)

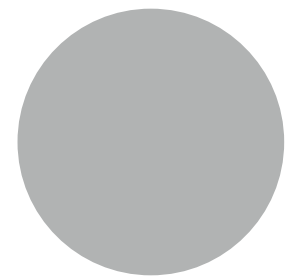

LIGHT GRAY
(LG)



CHAMPAGNE
(CP)

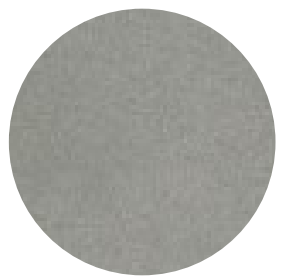

METALLIC SILVER
(MS)



NICKEL
(NK)

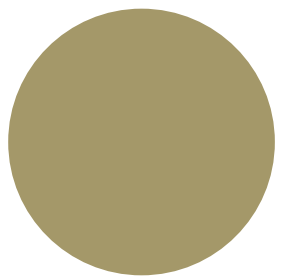

OCHRE
(OC)

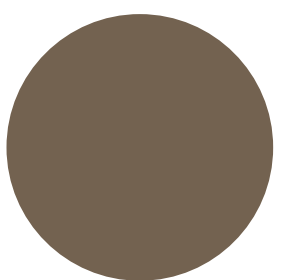

TAUPE
(TP)

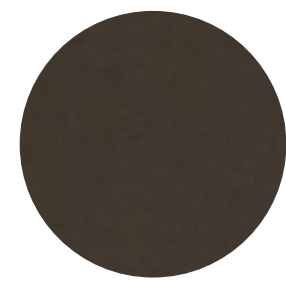

DARK BRONZE
(DB)

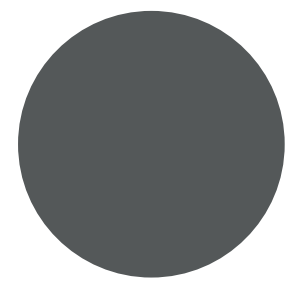

DARK GRAY
(DG)

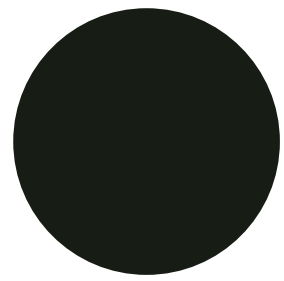

BLACK MATTE
(BM)

POLISHED METAL LEG FINISH

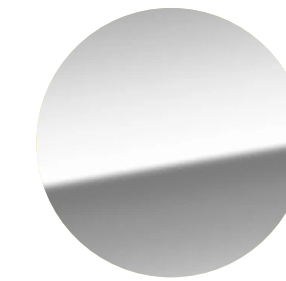

POLISHED
ALUMINUM
(AL)

WOOD LEG FINISH



NATURAL MAPLE
(83)





WHITE OAK
(81)



WALNUT
(85)

Share

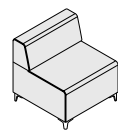
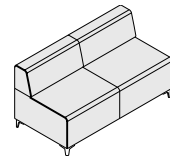
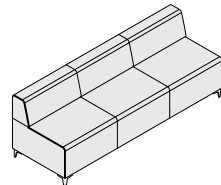
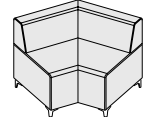
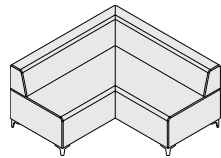
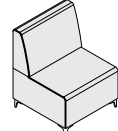
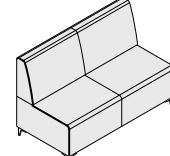
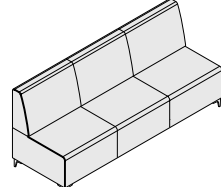
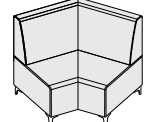
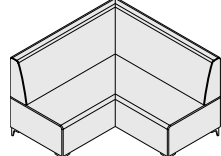
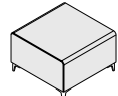
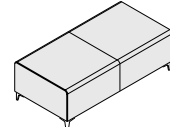
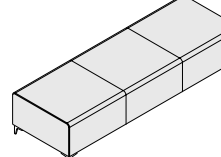
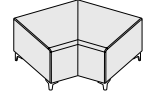
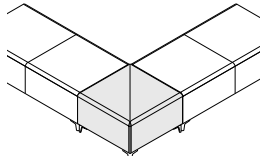
SPECIFICATION GUIDE: STATEMENT OF LINE

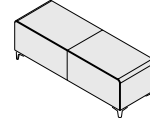
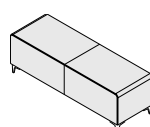
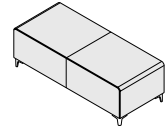
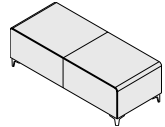
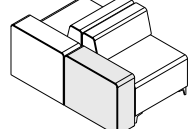
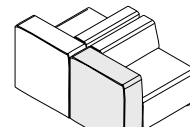
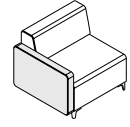
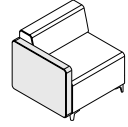
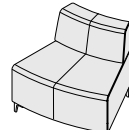
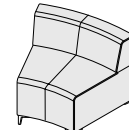
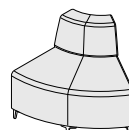
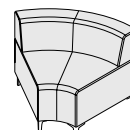
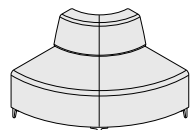
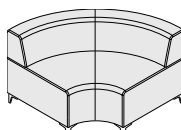
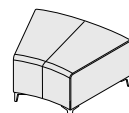
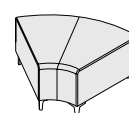
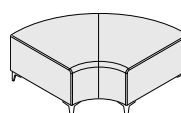
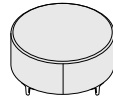
OVERVIEW						
Chairs Lounge Height Task Height	Single-Seater	Two-Seater	Three-Seater	120° Corner	90° Corner	
						
Banquette Chairs Task Height	Single-Seater	Two-Seater	Three-Seater	120° Corner	90° Corner	
						
Benches Lounge Height Task Height	Single-Seater	Two-Seater	Three-Seater	120° Corner	Outside Corner Bench	
						
End Cap Lounge Height Task Height	Single Narrow	Double Narrow	Double Narrow +	Double Wide	Double Wide +	
						
Knee Walls - 9"W Low Knee Wall / Armrest Height High Knee Wall / Seat Back Height	Low/Low+	High/High+	Arms - 4"W Armrest Height	24"H*	26"H*	* Armrest surface is 24" above the floor ** Armrest surface is 26" above the floor
						
Curved Chairs Lounge Height Task Height	30° Outside	30° Inside	60° Outside	60° Inside	90° Outside	90° Inside
						
Curved Benches Lounge Height Task Height	30° Inside	60° Inside	90° Inside	Round Ottomam Lounge Height Task Height		
						

GENERAL INFORMATION

Design
Stylex

Ganging

All individual units may be connected to one another with the use of a simple draw latch system.

Legs

Share is available with 3 leg options: corner, round, and wood. Angle and round legs are cast aluminum and may be polished or painted. The wood legs come in three standard finishes and are also available in custom finishes. Adjustable glides are standard.

Power In Knee Walls

Power receptacle offers onetouch accessibility to two different power ports: a usb 2.1A port and a standard, grounded 3-prong electrical outlet.

Power In Chairs And Benches

Power receptacle offers three exposed power ports: 2 usb 2.1A ports and a standard, grounded 3-prong electrical outlet.

Testing

Manufactured to comply with:
ANSI/BIFMA X5.4 Public and Lounge Seating Standard

Certifications

Greenguard Gold
LEVEL® 2

Share

SPECIFICATION GUIDE: OPTIONS AND ACCESSORIES

OVERVIEW

Chairs

Power Port Options

Right Side

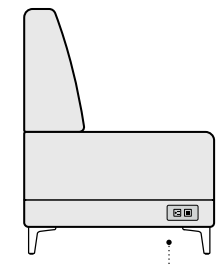

C14/C24

Front

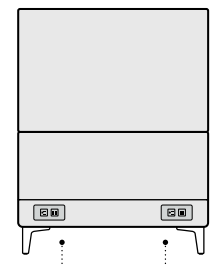

C13/C23

C12/C22

Left Side

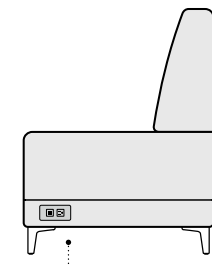

C11/C21

Back

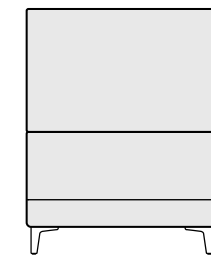

No Power Ports

Power Port Details

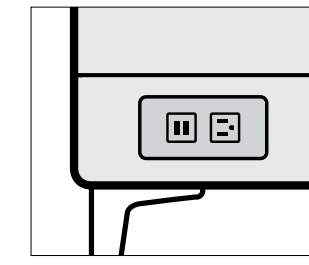

Power Plate

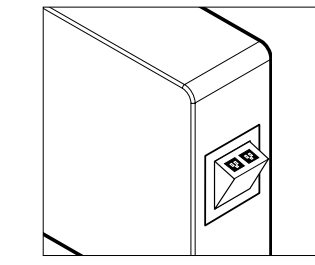

Knee Wall Flip Out Power

Benches

Power Port Options

Right Side

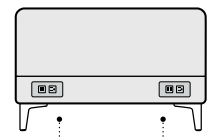

C15/C25

C14/C24

Front

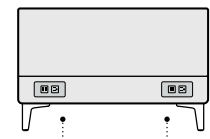

C13/C23

C12/C22

Left Side

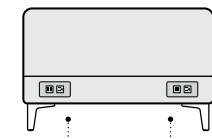

C11/C21

C18/C28

Back

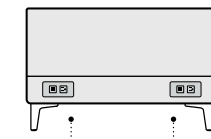

C17/C27

C16/C26

Accessories

Privacy Screen

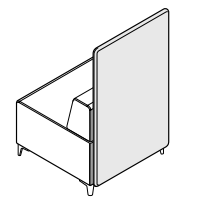

Cube Seats

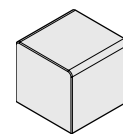

Leg Options

Corner Leg

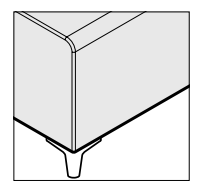

Round Leg

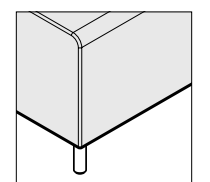

Wood Leg

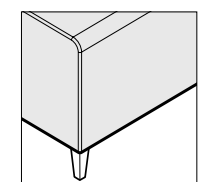

Ganging

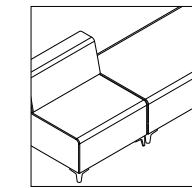

Cover Options

Standard

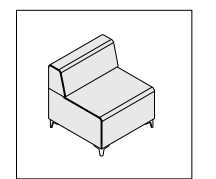

Waterline Mono-Color

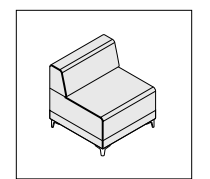

Waterline Dual-Color

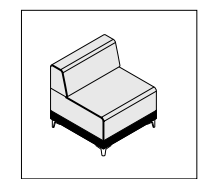

Seat & Back No Waterline

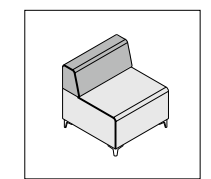

Seat & Back With Waterline

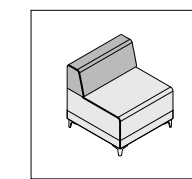

Tri-Color Upholstery Seat, Back & Waterline

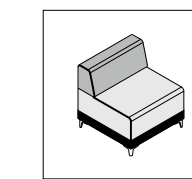

GENERAL INFORMATION

In-Seat Power Ports With 10' Or 20' Cord

Power Port Cord Length

C1× has a 10' power cord. C2× has a 20' power cord

Power Port Location

The power port location is determined by its last digit.

Examples:

- A C14 power port has a 10' power cord and is located on the right side of a chair or the right forward position of a bench.
- A C21 power port has a 20' power cord and is located on the left side of a chair or the left forward position of a bench.

Note:

Curved units may only have power ports located on the sides, not on the front or back. Power ports are not available on ottomans. Multiple power ports may be ordered per unit. The pricing shown is for each power port ordered.

In-Seat Power Port Finish

Power ports can be finished in any standard powder coat available.

Power In Chairs And Benches

Power receptacle offers three exposed power ports: 2 USB 2.1A ports and a standard, grounded 3-prong electrical outlet.

Power In Knee Walls

Power receptacle offers one-touch accessibility to two different power ports: a USB 2.1A port and a standard, grounded 3-prong electrical outlet.

Ganging

All individual units may be connected to one another with the use of a simple draw latch system.

Legs

Share is available with 3 leg options: angle, round, and wood. Angle and round legs are cast aluminum and may be polished or painted. The wood legs come in three standard finishes and are also available in custom finishes. Adjustable glides are standard.

Share

SPECIFICATION GUIDE: DIMENSIONS

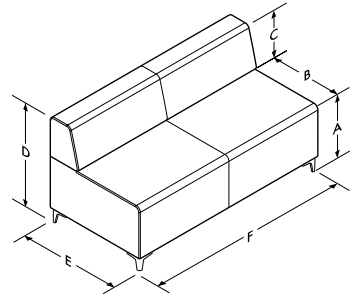
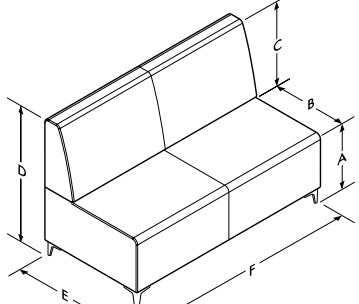
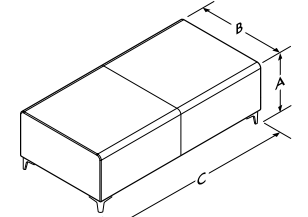
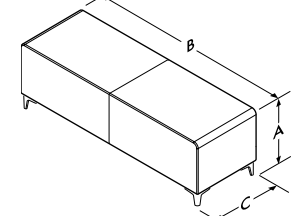
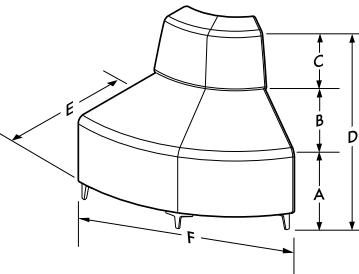
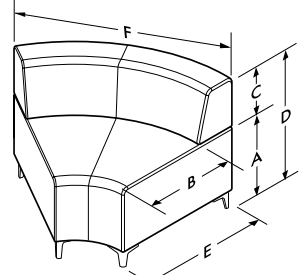
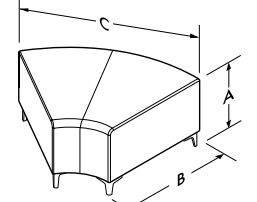
OVERVIEW	TASK HEIGHT			LOUNGE HEIGHT		
Chairs A. Seat Height B. Seat Depth C. Back Height D. Overall Height E. Overall Depth F. Overall Width 	Single-Seater A. 18" B. 19" C. 11" D. 29" E. 28" F. 28"	Two-Seater A. 18" B. 19" C. 11" D. 29" E. 28" F. 56"	Three-Seater A. 18" B. 19" C. 11" D. 29" E. 28" F. 84"	Single-Seater A. 16" B. 19" C. 13" D. 29" E. 28" F. 28"	Two-Seater A. 16" B. 19" C. 13" D. 29" E. 28" F. 56"	Three-Seater A. 16" B. 19" C. 13" D. 29" E. 28" F. 84"
Banquette Chairs A. Seat Height B. Seat Depth C. Back Height D. Overall Height E. Overall Depth F. Overall Width 	Single-Seater A. 18" B. 19" C. 18" D. 36" E. 28" F. 28"	Two-Seater A. 18" B. 19" C. 18" D. 36" E. 28" F. 56"	Three-Seater A. 18" B. 19" C. 18" D. 36" E. 28" F. 84"	-	-	-
Benches A. Overall/Seat Height B. Seat Depth C. Overall Width 	Single-Seater A. 18" B. 28" C. 28"	Two-Seater A. 18" B. 28" C. 56"	Three-Seater A. 18" B. 28" C. 84"	Single-Seater A. 16" B. 28" C. 28"	Two-Seater A. 16" B. 28" C. 56"	Three-Seater A. 16" B. 28" C. 84"
End Caps - Narrow A. Height B. Depth C. Width 	Single A. 18" B. 28" C. 19"	Double A. 18" B. 56" C. 19"	Double + A. 18" B. 57" C. 19"	Single A. 16" B. 28" C. 19"	Double A. 16" B. 56" C. 19"	Double + A. 16" B. 57" C. 19"
Curved Outside Chairs A. Seat Height B. Seat Depth C. Back Height D. Overall Height E. Overall Depth F. Overall Width 	30° A. 18" B. 19" C. 11" D. 29" E. 28" F. 35"	60° A. 18" B. 19" C. 11" D. 29" E. 28" F. 38.875"	90° A. 18" B. 19" C. 11" D. 29" E. 28" F. 56.25"	30° A. 16" B. 19" C. 13" D. 29" E. 28" F. 35"	60° A. 16" B. 19" C. 13" D. 29" E. 28" F. 38.875"	90° A. 16" B. 19" C. 13" D. 29" E. 28" F. 56.25"
Curved Inside Chairs A. Seat Height B. Seat Depth C. Back Height D. Overall Height E. Overall Depth F. Overall Width 	30° A. 18" B. 19" C. 11" D. 29" E. 28" F. 35"	60° A. 18" B. 19" C. 11" D. 29" E. 28" F. 39.75"	90° A. 18" B. 19" C. 11" D. 29" E. 28" F. 56.25"	30° A. 16" B. 19" C. 13" D. 29" E. 28" F. 35"	60° A. 16" B. 19" C. 13" D. 29" E. 28" F. 39.75"	90° A. 16" B. 19" C. 13" D. 29" E. 28" F. 56.25"
Curved Benches A. Height B. Depth C. Width 	30° A. 18" B. 28" C. 35"	60° A. 18" B. 28" C. 39.75"	90° A. 18" B. 28" C. 56.25"	30° A. 16" B. 28" C. 35"	60° A. 16" B. 28" C. 39.75"	90° A. 16" B. 28" C. 56.25"

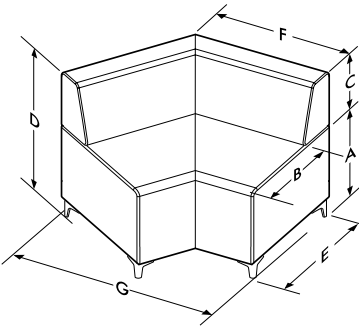
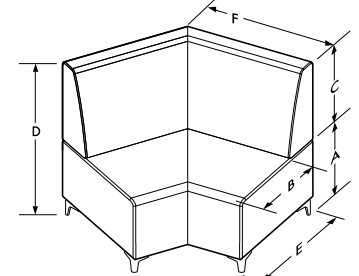
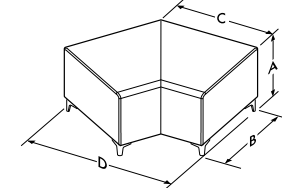
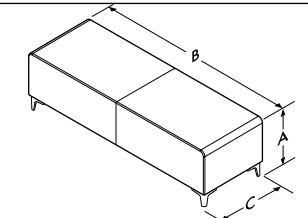
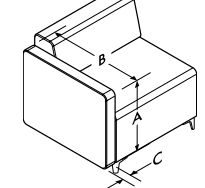
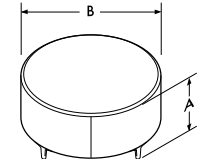
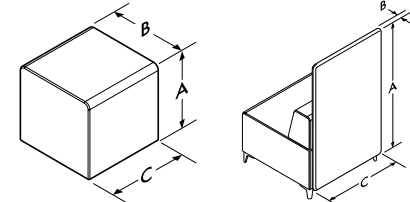
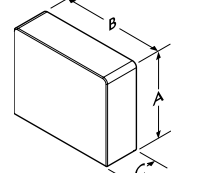
OVERVIEW	TASK HEIGHT		LOUNGE HEIGHT		
Corners A. Seat Height B. Seat Depth To Back C. Back Height D. Overall Height E. Overall Seat Depth F. Back Width G. Overall Width 	120° A. 18" B. 19" C. 11" D. 29" E. 28" F. 28" G. 42.5"	90° A. 18" B. 19" C. 11" D. 29" E. 28" F. 56"	120° A. 16" B. 19" C. 13" D. 29" E. 28" F. 28" G. 42.5"	90° A. 16" B. 19" C. 13" D. 29" E. 28" F. 56"	
Banquette Corners A. Seat Height B. Seat Depth To Back C. Back Height D. Overall Height E. Overall Seat Depth F. Back Width G. Overall Width 	120° A. 18" B. 19" C. 18" D. 36" E. 28" F. 28" G. 42.5"	90° A. 18" B. 19" C. 18" D. 36" E. 28" F. 56"	-	-	
Corner Benches A. Overall/Seat Height B. Seat Depth C. Seat Width D. Overall Width 	120° A. 18" B. 28" C. 28" D. 42.5"	Outside Corner A. 18" B. 28" C. 28" D. 28"	120° A. 16" B. 28" C. 28" D. 42.5"	Outside Corner A. 18" B. 28" C. 28" D. 28"	
End Caps - Wide A. Height B. Depth C. Width 	Double A. 16" B. 56" C. 28"	Double + A. 16" B. 57" C. 28"	Double A. 16" B. 56" C. 28"	Double + A. 16" B. 57" C. 28"	
Arms A. Height B. Depth C. Width 	26" A. 22" B. 28" C. 4"	-	24" A. 20" B. 28" C. 4"	-	
Round Ottoman A. Overall/Seat Height B. Overall Depth 	A. 18" B. 36"	-	A. 16" B. 36"	-	
Accessories A. Height B. Depth C. Width 	Cube Seat A. 18" B. 19" C. 19"	Privacy Screen A. 43" B. 1.25" C. 27"	Cube Seat A. 16" B. 19" C. 19"	-	
Knee Wells A. Height B. Depth C. Width 	Low A. 24" B. 28" C. 9"	Low A. 24" B. 28.5" C. 9"	High A. 29" B. 28" C. 9"	High A. 29" B. 28.5" C. 9"	-

Share

SPECIFICATION GUIDE: IDEA STARTERS

IDEA STARTERS

Idea Starter 1



Idea Starter 2



Idea Starter 3



Idea Starter 4



Idea Starter 5



Idea Starter 6



SPECIFICATION TOOLS

Idea Starters Online and in CET

At Stylex, we have a constant eye towards making our products easy to specify. Our Design Application team is working on layouts every day, so we have built an online library of the most requested layouts, with all the accompanying information, files, and pricing. We believe these will make our products easier to specify, and in turn help kick start your project. You can also find these in CET; please check out our 'Idea Starters' tab on for the easiest way to drag-and-drop right into your layout. Visit [Stylexdesign.com/idea-starters](https://stylexdesign.com/idea-starters) to get started.

Share

SPECIFICATION GUIDE: HOW TO ORDER

MODEL CODE BREAKDOWN - SEATING

Sample Model Code: SH1116L381C11YL1COM



SH

1116

L381

C11YL

U1

COM

1. Series	2. Series/Type/Seat	3. Leg	5. Options	6. Upholstery Style	7. Upholstery		
<p>Series</p> <p>SH SHARE</p>	<p>Series/Type/Seat</p> <p>1116 SINGLE SEATER CHAIR - LOUNGE HEIGHT 1118 SINGLE SEATER CHAIR - TASK HEIGHT 7118 SINGLE SEATER BANQUETTE - TASK HEIGHT 1126 TWO-SEATER CHAIR - LOUNGE HEIGHT 1128 TWO-SEATER CHAIR - TASK HEIGHT 7128 TWO-SEATER BANQUETTE - TASK HEIGHT 1136 THREE-SEATER CHAIR - LOUNGE HEIGHT 1138 THREE-SEATER CHAIR - TASK HEIGHT 7138 THREE-SEATER BANQUETTE - TASK HEIGHT 1226 90DEG CHAIR - LOUNGE HEIGHT 1228 90DEG CHAIR - TASK HEIGHT 7228 90DEG BANQUETTE - TASK HEIGHT 1246 120DEG CHAIR - LOUNGE HEIGHT 1248 120DEG CHAIR - TASK HEIGHT 7248 120DEG BANQUETTE - TASK HEIGHT 1556 OUT 30DEG CURVED CHAIR - LOUNGE HEIGHT 1558 OUT 30DEG CURVED CHAIR - TASK HEIGHT 1566 OUT 60DEG CURVED CHAIR - LOUNGE HEIGHT 1568 OUT 60DEG CURVED CHAIR - TASK HEIGHT 1576 OUT 90DEG CURVED CHAIR - LOUNGE HEIGHT 1578 OUT 90DEG CURVED CHAIR - TASK HEIGHT 1456 IN 30DEG CURVED CHAIR - LOUNGE HEIGHT 1458 IN 30DEG CURVED CHAIR - TASK HEIGHT 1466 IN 60DEG CURVED CHAIR - LOUNGE HEIGHT 1468 IN 60DEG CURVED CHAIR - TASK HEIGHT 1476 IN 90DEG CURVED CHAIR - LOUNGE HEIGHT 1478 IN 90DEG CURVED CHAIR - TASK HEIGHT 0116 SINGE SEATER BENCH - LOUNGE HEIGHT 0118 SINGLE SEATER BENCH - TASK HEIGHT 0126 TWO SEATER BENCH - LOUNGE HEIGHT 0128 TWO SEATER BENCH - TASK HEIGHT 0136 THREE SEATER BENCH - LOUNGE HEIGHT 0138 THREE SEATER BENCH - TASK HEIGHT</p>	<p>0246 120DEG BENCH - LOUNGE HEIGHT 0248 120DEG BENCH - TASK HEIGHT 0456 30DEG CURVED BENCH - LOUNGE HEIGHT 0458 30DEG CURVED BENCH - TASK HEIGHT 0466 60DEG CURVED BENCH - LOUNGE HEIGHT 0468 60DEG CURVED BENCH - TASK HEIGHT 0476 90DEG CURVED BENCH - LOUNGE HEIGHT 0478 90DEG CURVED BENCH - TASK HEIGHT 0486 ROUND OTTOMAN LOUNGE 0488 ROUND OTTOMAN TASK 0306 SINGLE NARROW END CAP - LOUNGE HEIGHT 0308 SINGLE NARROW END CAP - TASK HEIGHT 0316 DOUBLE NARROW END CAP - LOUNGE HEIGHT 0318 DOUBLE NARROW END CAP - TASK HEIGHT 0326 DOUBLE NARROW END CAP+ - LOUNGE HEIGHT 0328 DOUBLE NARROW END CAP+ - TASK HEIGHT 0346 DOUBLE WIDE END CAP - LOUNGE HEIGHT 0348 DOUBLE WIDE END CAP - TASK HEIGHT 0356 DOUBLE WIDE END CAP+ - LOUNGE HEIGHT 0358 DOUBLE WIDE END CAP+ - TASK HEIGHT 0616 OUTSIDE 90 CORNER BENCH LOUNGE HEIGHT 0618 OUTSIDE 90 CORNER BENCH TASK HEIGHT 241 24H LOW KNEE WALL 242 24H LOW KNEE WALL+ 546 24H LOUNGE CHAIR ARM 548 24H TASK CHAIR ARM 568 26H TASK CHAIR ARM 291 29H HIGH KNEE WALL 292 29H HIGH KNEE WALL+ 4106 CUBE - LOUNGE HEIGHT 4108 CUBE - TASK HEIGHT 3100 PRIVACY SCREEN</p>	<p>Leg</p> <p>L1 CORNER LEG L2 ROUND LEG L3 WOOD LEG</p> <p>Leg Finish</p> <p>Standard Powder Coat</p> <p>BL BLUE BM BLACK MATTE CP CHAMPAGNE DB DARK BRONZE DG DARK GRAY DP DUSTY PINK DS DARK SAGE LG LIGHT GRAY LL LILAC GRAY LP LIGHT PISTACHIO LR LIPSTICK RED MB MIDNIGHT BLUE MG MEADOW GREEN MK MILK MS METALLIC SILVER NK NICKEL OC OCHRE PY PALE YELLOW RO RED ORANGE RE RR RUSTY RED SB SOFT BLUE SD SAND TC TERRACOTTA TP TAUPE</p> <p>Polished Metal</p> <p>AL POLISHED ALUMINUM</p> <p>Wood</p> <p>81 WHITE OAK 83 NATURAL MAPLE 85 WALNUT 09 CUSTOM COLOR</p>	<p>Ganging</p> <p>SG GANGING</p> <p>Power Cord Length</p> <p>C1 10' CABLE C2 20' CABLE</p> <p>Power Port Position</p> <p>1 POSITION 1 2 POSITION 2 3 POSITION 3 4 POSITION 4 5 POSITION 5 6 POSITION 6 7 POSITION 7 8 POSITION 8</p> <p>Knee Wall</p> <p>Flip Out Power</p> <p>P10 9' CABLE P20 19' CABLE</p>	<p>Power Port Color</p> <p>Standard Powder Coat</p> <p>BL BLUE BM BLACK MATTE CP CHAMPAGNE DB DARK BRONZE DG DARK GRAY DP DUSTY PINK DS DARK SAGE LG LIGHT GRAY LL LILAC GRAY LP LIGHT PISTACHIO LR LIPSTICK RED MB MIDNIGHT BLUE MG MEADOW GREEN MK MILK MS METALLIC SILVER NK NICKEL OC OCHRE PY PALE YELLOW RO RED ORANGE RE RR RUSTY RED SB SOFT BLUE SD SAND TC TERRACOTTA TP TAUPE</p>	<p>Dual Upholstery</p> <p>U1 MONO-COLOR WATERLINE U2 DUAL-COLOR WATERLINE SEAT & BACK, NO WATERLINE U3 SEAT & BACK, WITH WATERLINE U4 TRI-COLOR - SEAT, BACK & WATERLINE</p>	<p>Textile Grades</p> <p>COM CUSTOMER'S OWN MATERIAL A GRADE A B GRADE B C GRADE C D GRADE D E GRADE E F GRADE F G GRADE G H GRADE H I GRADE I J GRADE J K GRADE K L GRADE L M GRADE M</p> <p>Note: Select highest grade in the case of dual upholstery</p>

Share

CHAIR: SINGLE-SEATER, LOUNGE HEIGHT

Textile Upholstery Grades

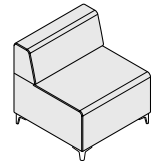
TITLE	SERIES	TYPE	SEAT	UPH	DIMENSIONS	YDG	COM	A	B	C	D	E	F	G	H	I	J	K	L	M	
 Chair, Single-Seater, Lounge Height	Standard Upholstery	SH	11	16	28W x 28D x 29H	2.8	2,227	2,462	2,592	2,720	2,846	2,976	3,119	3,262	3,429	3,643	3,901	4,009	4,254	4,458	
	Mono-Color Waterline	SH	11	16	U1	28W x 28D x 29H	2.8	2,417	2,655	2,783	2,912	3,040	3,169	3,312	3,454	3,620	3,836	4,093	4,200	4,444	4,649
	Dual-Color Waterline	SH	11	16	U2	28W x 28D x 29H	2.5 above Waterline 0.8 below Waterline	2,417	2,696	2,846	3,004	3,152	3,305	3,469	3,638	3,836	4,089	4,392	4,518	4,806	5,047
	No Waterline Back & Seat	SH	11	16	U3	28W x 28D x 29H	1.2 Back 1.6 Seat	2,227	2,462	2,592	2,720	2,846	2,976	3,119	3,262	3,429	3,643	3,901	4,009	4,254	4,458
	Waterline Back & Seat	SH	11	16	U4	28W x 28D x 29H	1.2 Back 1.6 Seat/below Waterline	2,417	2,655	2,783	2,912	3,040	3,169	3,312	3,454	3,620	3,836	4,093	4,200	4,444	4,649
	Triple-Back & Seat & Waterline	SH	11	16	U8	28W x 28D x 29H	0.8 below Waterline 1.2 Back 1.3 Seat/above Waterline	2,417	2,696	2,846	3,004	3,152	3,305	3,469	3,638	3,836	4,089	4,392	4,518	4,806	5,047

To Order Select Below

1. Series/Type/Seat

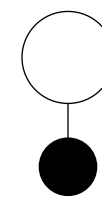

SH1116

Share
Chair, Single-Seater,
Lounge Height

2. Leg

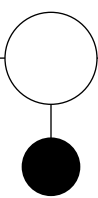

Leg

- L1 CORNER LEG, ADJ. PLASTIC GLIDES
- L2 ROUND LEG, ADJ. PLASTIC GLIDES
- L3 WOOD LEG

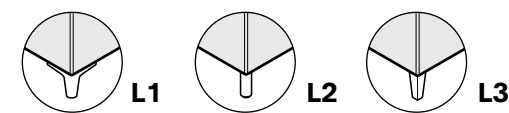

Mobility

The round leg glide has a larger diameter (1") than the corner leg for easier sliding on low pile carpet. Stylex is not responsible for damage to carpeting or floors.

3. Leg Finish

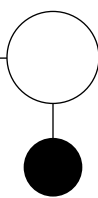

Standard Powder Coated Metal

- BL BLUE
- BM BLACK MATTE
- CP CHAMPAGNE
- DB DARK BRONZE
- DG DARK GRAY
- DP DUSTY PINK
- DS DARK SAGE
- LG LIGHT GRAY
- LL LILAC GRAY
- LP LIGHT PISTACHIO
- LR LIPSTICK RED
- MB MIDNIGHT BLUE

- MG MEADOW GREEN
- MK MILK
- MS METALLIC SILVER
- NK NICKEL
- OC OCHRE
- PY PALE YELLOW
- RO RED ORANGE
- RR RUSTY RED
- SB SOFT BLUE
- SD SAND
- TC TERRACOTTA
- TP TAUPE

4. Options

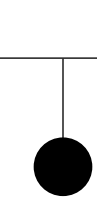

Polished Aluminum

- AL POLISHED ALUMINUM

Wood Finish +224

- 81 WHITE OAK
- 83 NATURAL MAPLE
- 85 WALNUT

Custom Color Match

- 09 CUSTOM COLOR

Per order per color - 20 chair minimum.
Contact customer service for details.

4. Options

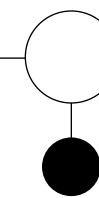

Ganging

- SG GANGING +53

Used to connect chairs to adjacent chairs or benches.

Power

- IN-SEAT POWER
C1X PORT W/10' CORD +452
- IN-SEAT POWER
C2X PORT W/20' CORD +485

See [page 7](#) for power port spec info.

Power Port Finish

Power ports can be finished in any standard powder coat available.

5. Upholstery Style

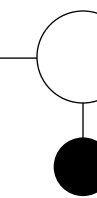

Upholstery Style

- U1 MONO-COLOR WATERLINE
- U2 DUAL-COLOR WATERLINE
- U3 SEAT & BACK, NO WATERLINE
- U4 SEAT & BACK, WITH WATERLINE
- U8 TRI-COLOR - SEAT, BACK & WATERLINE

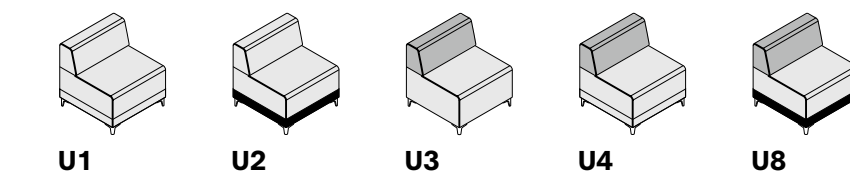

When pricing models with more than one fabric, the higher grade fabric will determine the overall grade of the specific product.

6. Upholstery

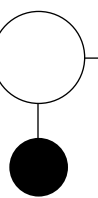

Upholstery

See [general information section](#) for details on textile program and COM/COL information.

Share will develop comfort wrinkles over time. The extent of these wrinkles is determined by the fabric specified.

Share

CHAIR: SINGLE-SEATER, TASK HEIGHT

Textile Upholstery Grades

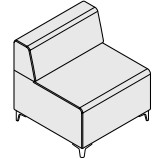
TITLE	SERIES	TYPE	SEAT	UPH	DIMENSIONS	YDG	COM	A	B	C	D	E	F	G	H	I	J	K	L	M	
Chair, Single-Seater, Task Height 	Standard Upholstery	SH	11	18	28W x 28D x 29H	2.8	2,227	2,462	2,592	2,720	2,846	2,976	3,119	3,262	3,429	3,643	3,901	4,009	4,254	4,458	
	Mono-Color Waterline	SH	11	18	U1	28W x 28D x 29H	2.8	2,417	2,655	2,783	2,912	3,040	3,169	3,312	3,454	3,620	3,836	4,093	4,200	4,444	4,649
	Dual-Color Waterline	SH	11	18	U2	28W x 28D x 29H	2.5 above Waterline 0.8 below Waterline	2,417	2,696	2,846	3,004	3,152	3,305	3,469	3,638	3,836	4,089	4,392	4,518	4,806	5,047
	No Waterline Back & Seat	SH	11	18	U3	28W x 28D x 29H	1.1 Back 1.7 Seat	2,227	2,462	2,592	2,720	2,846	2,976	3,119	3,262	3,429	3,643	3,901	4,009	4,254	4,458
	Waterline Back & Seat	SH	11	18	U4	28W x 28D x 29H	1.1 Back 1.7 Seat/below Waterline	2,417	2,655	2,783	2,912	3,040	3,169	3,312	3,454	3,620	3,836	4,093	4,200	4,444	4,649
	Triple-Back & Seat & Waterline	SH	11	18	U8	28W x 28D x 29H	0.8 below Waterline 1.1 Back 1.4 Seat/above Waterline	2,417	2,696	2,846	3,004	3,152	3,305	3,469	3,638	3,836	4,089	4,392	4,518	4,806	5,047

To Order Select Below

1. Series/Type/Seat

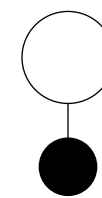

SH1118

Share
Chair, Single-Seater,
Task Height

2. Leg

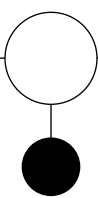

Leg

- L1 CORNER LEG, ADJ. PLASTIC GLIDES
- L2 ROUND LEG, ADJ. PLASTIC GLIDES
- L3 WOOD LEG

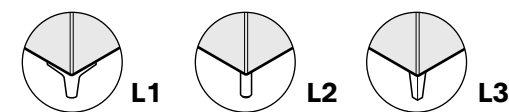

Mobility

The round leg glide has a larger diameter (1") than the corner leg for easier sliding on low pile carpet. Stylex is not responsible for damage to carpeting or floors.

3. Leg Finish

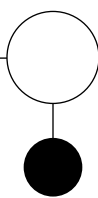

Standard Powder Coated Metal

- BL BLUE
- BM BLACK MATTE
- CP CHAMPAGNE
- DB DARK BRONZE
- DG DARK GRAY
- DP DUSTY PINK
- DS DARK SAGE
- LG LIGHT GRAY
- LL LILAC GRAY
- LP LIGHT PISTACHIO
- LR LIPSTICK RED
- MB MIDNIGHT BLUE

- MG MEADOW GREEN
- MK MILK
- MS METALLIC SILVER
- NK NICKEL
- OC OCHRE
- PY PALE YELLOW
- RO RED ORANGE
- RR RUSTY RED
- SB SOFT BLUE
- SD SAND
- TC TERRACOTTA
- TP TAUPE

4. Options

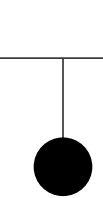

Polished Aluminum

- AL POLISHED ALUMINUM

Wood Finish +224

- 81 WHITE OAK
- 83 NATURAL MAPLE
- 85 WALNUT

Custom Color Match

- 09 CUSTOM COLOR

Per order per color - 20 chair minimum.
Contact customer service for details.

4. Options

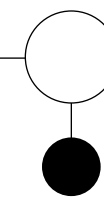

Ganging

- SG GANGING **+53**

Used to connect chairs to adjacent chairs or benches.

Power

- IN-SEAT POWER
C1X PORT W/10' CORD **+452**
- IN-SEAT POWER
C2X PORT W/20' CORD **+485**

See [page 7](#) for power port spec info.

Power Port Finish

Power ports can be finished in any standard powder coat available.

5. Upholstery Style

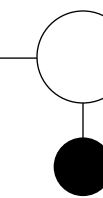

Upholstery Style

- U1 MONO-COLOR WATERLINE
- U2 DUAL-COLOR WATERLINE
- U3 SEAT & BACK, NO WATERLINE
- U4 SEAT & BACK, WITH WATERLINE
- U8 TRI-COLOR - SEAT, BACK & WATERLINE

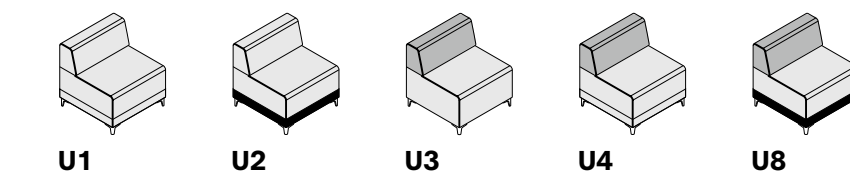

When pricing models with more than one fabric, the higher grade fabric will determine the overall grade of the specific product.

6. Upholstery

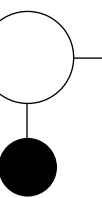

Upholstery

See [general information section](#) for details on textile program and COM/COL information.

Share will develop comfort wrinkles over time. The extent of these wrinkles is determined by the fabric specified.

Share

CHAIR: SINGLE-SEATER, BANQUETTE HEIGHT

Textile Upholstery Grades

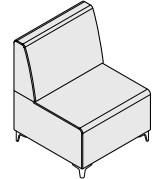
TITLE	SERIES	TYPE	SEAT	UPH	DIMENSIONS	YDG	COM	A	B	C	D	E	F	G	H	I	J	K	L	M	
 Chair, Single-Seater, Banquette Height	Standard Upholstery	SH	71	18	28W x 28D x 36H	3.1	2,525	2,788	2,931	3,069	3,212	3,356	3,512	3,671	3,853	4,096	4,380	4,487	4,760	4,957	
	Mono-Color Waterline	SH	71	18	U1	28W x 28D x 36H	3.1	2,715	2,978	3,122	3,261	3,404	3,546	3,703	3,860	4,046	4,286	4,572	4,671	4,941	5,144
	Dual-Color Waterline	SH	71	18	U2	28W x 28D x 36H	2.8 above Waterline 0.8 below Waterline	2,715	3,020	3,187	3,348	3,513	3,681	3,863	4,046	4,260	4,539	4,870	5,002	5,319	5,549
	No Waterline Back & Seat	SH	71	18	U3	28W x 28D x 36H	1.4 Back 1.7 Seat	2,525	2,788	2,931	3,069	3,212	3,356	3,512	3,671	3,853	4,096	4,380	4,487	4,760	4,957
	Waterline Back & Seat	SH	71	18	U4	28W x 28D x 36H	1.4 Back 1.8 Seat/below Waterline	2,715	2,978	3,122	3,261	3,404	3,546	3,703	3,860	4,046	4,286	4,572	4,671	4,941	5,144
	Triple-Back & Seat & Waterline	SH	71	18	U8	28W x 28D x 36H	0.8 below Waterline 1.4 Back 1.4 Seat/above Waterline	2,715	3,020	3,187	3,348	3,513	3,681	3,863	4,046	4,260	4,539	4,870	5,002	5,319	5,549

To Order Select Below

1. Series/Type/Seat

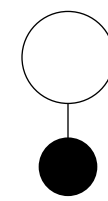

SH7118

Share
Chair, Single-Seater,
Banquette Height

2. Leg

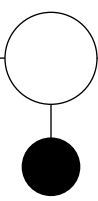

Leg

- L1 CORNER LEG, ADJ. PLASTIC GLIDES
- L2 ROUND LEG, ADJ. PLASTIC GLIDES
- L3 WOOD LEG

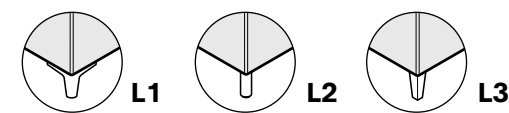

Mobility

The round leg glide has a larger diameter (1") than the corner leg for easier sliding on low pile carpet. Stylex is not responsible for damage to carpeting or floors.

3. Leg Finish

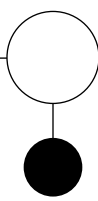

Standard Powder Coated Metal

- BL BLUE
- BM BLACK MATTE
- CP CHAMPAGNE
- DB DARK BRONZE
- DG DARK GRAY
- DP DUSTY PINK
- DS DARK SAGE
- LG LIGHT GRAY
- LL LILAC GRAY
- LP LIGHT PISTACHIO
- LR LIPSTICK RED
- MB MIDNIGHT BLUE

- MG MEADOW GREEN
- MK MILK
- MS METALLIC SILVER
- NK NICKEL
- OC OCHRE
- PY PALE YELLOW
- RO RED ORANGE
- RR RUSTY RED
- SB SOFT BLUE
- SD SAND
- TC TERRACOTTA
- TP TAUPE

4. Options

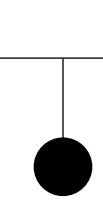

Polished Aluminum

- AL POLISHED ALUMINUM

Wood Finish +224

- 81 WHITE OAK
- 83 NATURAL MAPLE
- 85 WALNUT

Custom Color Match

- 09 CUSTOM COLOR

Per order per color - 20 chair minimum.
Contact customer service for details.

4. Options

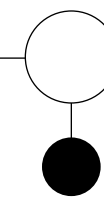

Ganging

- SG GANGING +53

Used to connect chairs to adjacent chairs or benches.

Power

- IN-SEAT POWER
C1X PORT W/10' CORD +452
- IN-SEAT POWER
C2X PORT W/20' CORD +485

See [page 7](#) for power port spec info.

Power Port Finish

Power ports can be finished in any standard powder coat available.

5. Upholstery Style

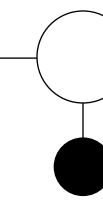

Upholstery Style

- U1 MONO-COLOR WATERLINE
- U2 DUAL-COLOR WATERLINE
- U3 SEAT & BACK, NO WATERLINE
- U4 SEAT & BACK, WITH WATERLINE
- U8 TRI-COLOR - SEAT, BACK & WATERLINE

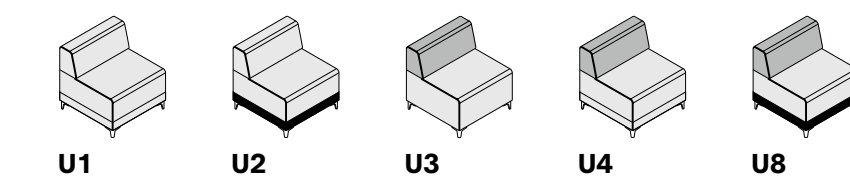

When pricing models with more than one fabric, the higher grade fabric will determine the overall grade of the specific product.

6. Upholstery

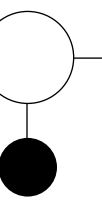

Upholstery

See [general information section](#) for details on textile program and COM/COL information.

Share will develop comfort wrinkles over time. The extent of these wrinkles is determined by the fabric specified.

Share

CHAIR: TWO-SEATER, LOUNGE HEIGHT

Textile Upholstery Grades

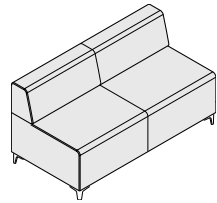
TITLE	SERIES	TYPE	SEAT	UPH	DIMENSIONS	YDG	COM	A	B	C	D	E	F	G	H	I	J	K	L	M	
 <p>Chair, Two-Seater, Lounge Height</p>	Standard Upholstery	SH	11	26	56W x 28D x 29H	5.6	3,684	4,156	4,412	4,671	4,929	5,188	5,471	5,758	6,089	6,518	7,036	7,249	7,739	8,147	
	Mono-Color Waterline	SH	11	26	U1	56W x 28D x 29H	5.7	3,951	4,434	4,697	4,957	5,220	5,482	5,770	6,062	6,400	6,840	7,362	7,580	8,078	8,494
	Dual-Color Waterline	SH	11	26	U2	56W x 28D x 29H	4.9 above Waterline 0.9 below Waterline	3,951	4,441	4,708	4,977	5,243	5,510	5,803	6,098	6,444	6,889	7,424	7,644	8,150	8,574
	No Waterline Back & Seat	SH	11	26	U3	56W x 28D x 29H	2.4 Back 3.2 Seat	3,684	4,156	4,412	4,671	4,929	5,188	5,471	5,758	6,089	6,518	7,036	7,249	7,739	8,147
	Waterline Back & Seat	SH	11	26	U4	56W x 28D x 29H	2.4 Back 3.2 Seat/below Waterline	3,951	4,434	4,697	4,957	5,220	5,482	5,770	6,062	6,400	6,840	7,362	7,516	8,006	8,415
	Triple-Back & Seat & Waterline	SH	11	26	U8	56W x 28D x 29H	0.9 below Waterline 2.4 Back 2.5 Seat/above Waterline	3,951	4,441	4,708	4,977	5,243	5,510	5,803	6,098	6,444	6,889	7,424	7,644	8,150	8,574

To Order Select Below

1. Series/Type/Seat

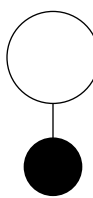

SH1126

**Share
Chair, Two-Seater,
Lounge Height**

2. Leg

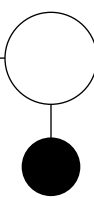

Leg

- L1 CORNER LEG, ADJ. PLASTIC GLIDES
- L2 ROUND LEG, ADJ. PLASTIC GLIDES
- L3 WOOD LEG

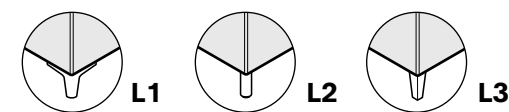

Mobility

The round leg glide has a larger diameter (1") than the corner leg for easier sliding on low pile carpet. Stylex is not responsible for damage to carpeting or floors.

3. Leg Finish

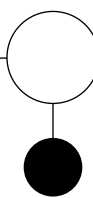

Standard Powder Coated Metal

- BL BLUE
- BM BLACK MATTE
- CP CHAMPAGNE
- DB DARK BRONZE
- DG DARK GRAY
- DP DUSTY PINK
- DS DARK SAGE
- LG LIGHT GRAY
- LL LILAC GRAY
- LP LIGHT PISTACHIO
- LR LIPSTICK RED
- MB MIDNIGHT BLUE

- MG MEADOW GREEN
- MK MILK
- MS METALLIC SILVER
- NK NICKEL
- OC OCHRE
- PY PALE YELLOW
- RO RED ORANGE
- RR RUSTY RED
- SB SOFT BLUE
- SD SAND
- TC TERRACOTTA
- TP TAUPE

4. Options

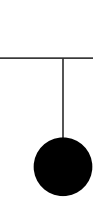

Polished Aluminum

- AL POLISHED ALUMINUM

Wood Finish +224

- 81 WHITE OAK
- 83 NATURAL MAPLE
- 85 WALNUT

Custom Color Match

- 09 CUSTOM COLOR

Per order per color - 20 chair minimum.
Contact customer service for details.

4. Options

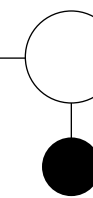

Ganging

- SG GANGING **+53**

Used to connect chairs to adjacent chairs or benches.

Power

- IN-SEAT POWER
C1X PORT W/10' CORD **+452**
- IN-SEAT POWER
C2X PORT W/20' CORD **+485**

See [page 7](#) for power port spec info.

Power Port Finish

Power ports can be finished in any standard powder coat available.

5. Upholstery Style

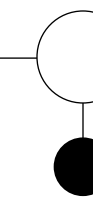

Upholstery Style

- U1 MONO-COLOR WATERLINE
- U2 DUAL-COLOR WATERLINE
- U3 SEAT & BACK, NO WATERLINE
- U4 SEAT & BACK, WITH WATERLINE
- U8 TRI-COLOR - SEAT, BACK & WATERLINE

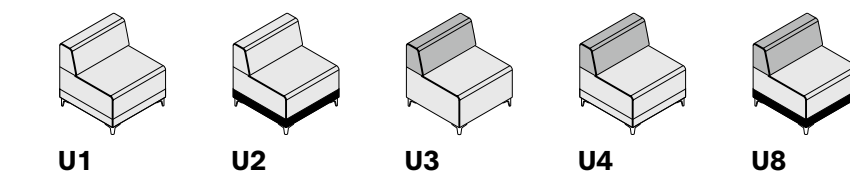

When pricing models with more than one fabric, the higher grade fabric will determine the overall grade of the specific product.

6. Upholstery

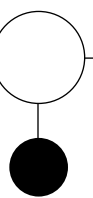

Upholstery

See general information section for details on textile program and COM/COL information.

Share will develop comfort wrinkles over time. The extent of these wrinkles is determined by the fabric specified.

Share

CHAIR: TWO-SEATER, TASK HEIGHT

Textile Upholstery Grades

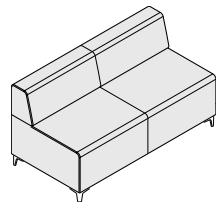
TITLE	SERIES	TYPE	SEAT	UPH	DIMENSIONS	YDG	COM	A	B	C	D	E	F	G	H	I	J	K	L	M	
Chair, Two-Seater, Task Height 	Standard Upholstery	SH	11	28	56W x 28D x 29H	5.6	3,684	4,156	4,412	4,671	4,929	5,188	5,471	5,758	6,089	6,518	7,036	7,249	7,739	8,147	
	Mono-Color Waterline	SH	11	28	U1	56W x 28D x 29H	5.7	3,951	4,434	4,697	4,957	5,220	5,482	5,770	6,062	6,400	6,840	7,362	7,580	8,078	8,494
	Dual-Color Waterline	SH	11	28	U2	56W x 28D x 29H	4.9 above Waterline 0.9 below Waterline	3,951	4,441	4,708	4,977	5,243	5,510	5,803	6,098	6,444	6,889	7,424	7,644	8,150	8,574
	No Waterline Back & Seat	SH	11	28	U3	56W x 28D x 29H	2.2 Back 3.4 Seat	3,684	4,156	4,412	4,671	4,929	5,188	5,471	5,758	6,089	6,518	7,036	7,249	7,739	8,147
	Waterline Back & Seat	SH	11	28	U4	56W x 28D x 29H	2.2 Back 3.4 Seat/below Waterline	3,951	4,434	4,697	4,957	5,220	5,482	5,770	6,062	6,400	6,840	7,362	7,516	8,006	8,415
	Triple-Back & Seat & Waterline	SH	11	28	U8	56W x 28D x 29H	0.9 below Waterline 2.2 Back 2.7 Seat/above Waterline	3,951	4,441	4,708	4,977	5,243	5,510	5,803	6,098	6,444	6,889	7,424	7,644	8,150	8,574

To Order Select Below

1. Series/Type/Seat

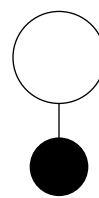

SH1128

Share
Chair, Two-Seater,
Task Height

2. Leg

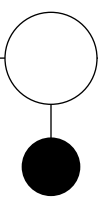

Leg

- L1 CORNER LEG, ADJ. PLASTIC GLIDES
- L2 ROUND LEG, ADJ. PLASTIC GLIDES
- L3 WOOD LEG

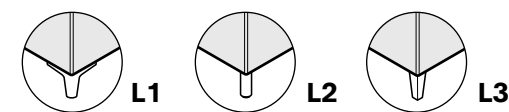

Mobility

The round leg glide has a larger diameter (1") than the corner leg for easier sliding on low pile carpet. Stylex is not responsible for damage to carpeting or floors.

3. Leg Finish

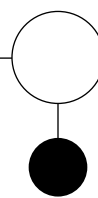

Standard Powder Coated Metal

- BL BLUE
- BM BLACK MATTE
- CP CHAMPAGNE
- DB DARK BRONZE
- DG DARK GRAY
- DP DUSTY PINK
- DS DARK SAGE
- LG LIGHT GRAY
- LL LILAC GRAY
- LP LIGHT PISTACHIO
- LR LIPSTICK RED
- MB MIDNIGHT BLUE

- MG MEADOW GREEN
- MK MILK
- MS METALLIC SILVER
- NK NICKEL
- OC OCHRE
- PY PALE YELLOW
- RO RED ORANGE
- RR RUSTY RED
- SB SOFT BLUE
- SD SAND
- TC TERRACOTTA
- TP TAUPE

4. Options

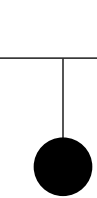

Polished Aluminum

- AL POLISHED ALUMINUM

Wood Finish +224

- 81 WHITE OAK
- 83 NATURAL MAPLE
- 85 WALNUT

Custom Color Match

- 09 CUSTOM COLOR

Per order per color - 20 chair minimum.
Contact customer service for details.

4. Options

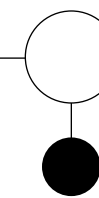

Ganging

- SG GANGING +53

Used to connect chairs to adjacent chairs or benches.

Power

- IN-SEAT POWER
C1X PORT W/10' CORD +452
- IN-SEAT POWER
C2X PORT W/20' CORD +485

See [page 7](#) for power port spec info.

Power Port Finish

Power ports can be finished in any standard powder coat available.

5. Upholstery Style

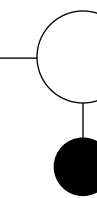

Upholstery Style

- U1 MONO-COLOR WATERLINE
- U2 DUAL-COLOR WATERLINE
- U3 SEAT & BACK, NO WATERLINE
- U4 SEAT & BACK, WITH WATERLINE
- U8 TRI-COLOR - SEAT, BACK & WATERLINE

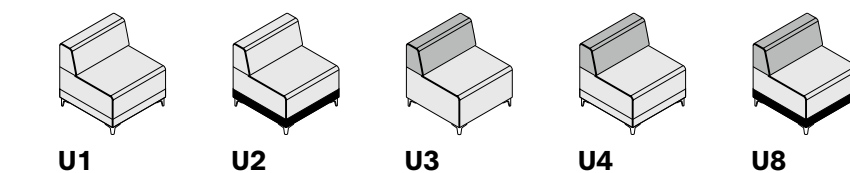

When pricing models with more than one fabric, the higher grade fabric will determine the overall grade of the specific product.

6. Upholstery

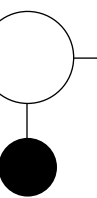

Upholstery

See [general information section](#) for details on textile program and COM/COL information.

Share will develop comfort wrinkles over time. The extent of these wrinkles is determined by the fabric specified.

Share

CHAIR: TWO-SEATER, BANQUETTE HEIGHT

Textile Upholstery Grades

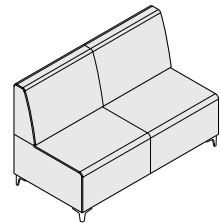
TITLE	SERIES	TYPE	SEAT	UPH	DIMENSIONS	YDG	COM	A	B	C	D	E	F	G	H	I	J	K	L	M
Chair, Two-Seater, Banquette Height 	Standard Upholstery	SH	71	28	56W x 28D x 36H	6.2	4,279	4,806	5,092	5,368	5,656	5,942	6,255	6,571	6,940	7,420	7,992	8,236	8,778	9,176
	Mono-Color Waterline	SH	71	28	56W x 28D x 36H	6.1	4,547	5,067	5,349	5,620	5,901	6,182	6,491	6,801	7,165	7,639	8,199	8,427	8,961	9,355
	Dual-Color Waterline	SH	71	28	56W x 28D x 36H	5.4 above Waterline 0.9 below Waterline	4,547	5,081	5,375	5,654	5,947	6,238	6,556	6,875	7,251	7,739	8,320	8,561	9,110	9,518
	No Waterline Back & Seat	SH	71	28	56W x 28D x 36H	2.7 Back 3.4 Seat	4,279	4,806	5,092	5,368	5,656	5,942	6,255	6,571	6,940	7,420	7,992	8,236	8,778	9,176
	Waterline Back & Seat	SH	71	28	56W x 28D x 36H	2.7 Back 3.5 Seat/below Waterline	4,547	5,067	5,349	5,620	5,901	6,182	6,491	6,801	7,165	7,639	8,199	8,427	8,961	9,355
	Triple-Back & Seat & Waterline	SH	71	28	56W x 28D x 36H	0.9 below Waterline 2.7 Back 2.7 Seat/above Waterline	4,547	5,081	5,375	5,654	5,947	6,238	6,556	6,875	7,251	7,739	8,320	8,561	9,110	9,518

To Order Select Below

1. Series/Type/Seat

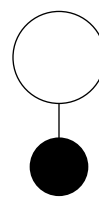

SH7128

Share
Chair, Two-Seater,
Banquette Height

2. Leg

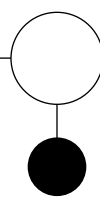

Leg

- L1 CORNER LEG, ADJ. PLASTIC GLIDES
- L2 ROUND LEG, ADJ. PLASTIC GLIDES
- L3 WOOD LEG

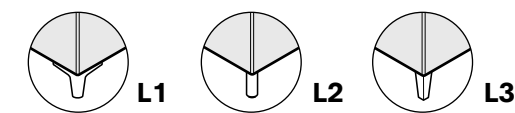

Mobility

The round leg glide has a larger diameter (1") than the corner leg for easier sliding on low pile carpet. Stylex is not responsible for damage to carpeting or floors.

3. Leg Finish

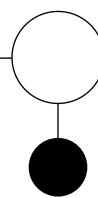

Standard Powder Coated Metal

- BL BLUE
- BM BLACK MATTE
- CP CHAMPAGNE
- DB DARK BRONZE
- DG DARK GRAY
- DP DUSTY PINK
- DS DARK SAGE
- LG LIGHT GRAY
- LL LILAC GRAY
- LP LIGHT PISTACHIO
- LR LIPSTICK RED
- MB MIDNIGHT BLUE

- MG MEADOW GREEN
- MK MILK
- MS METALLIC SILVER
- NK NICKEL
- OC OCHRE
- PY PALE YELLOW
- RO RED ORANGE
- RR RUSTY RED
- SB SOFT BLUE
- SD SAND
- TC TERRACOTTA
- TP TAUPE

4. Options

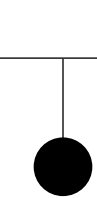

Polished Aluminum

- AL POLISHED ALUMINUM

Wood Finish +224

- 81 WHITE OAK
- 83 NATURAL MAPLE
- 85 WALNUT

Custom Color Match

- 09 CUSTOM COLOR

Per order per color - 20 chair minimum.
Contact customer service for details.

4. Options

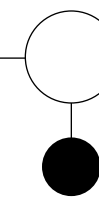

Ganging

- SG GANGING **+53**

Used to connect chairs to adjacent chairs or benches.

Power

- IN-SEAT POWER
C1X PORT W/10' CORD **+452**
- IN-SEAT POWER
C2X PORT W/20' CORD **+485**

See [page 7](#) for power port spec info.

Power Port Finish

Power ports can be finished in any standard powder coat available.

5. Upholstery Style

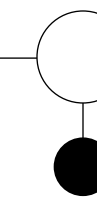

Upholstery Style

- U1 MONO-COLOR WATERLINE
- U2 DUAL-COLOR WATERLINE
- U3 SEAT & BACK, NO WATERLINE
- U4 SEAT & BACK, WITH WATERLINE
- U8 TRI-COLOR - SEAT, BACK & WATERLINE

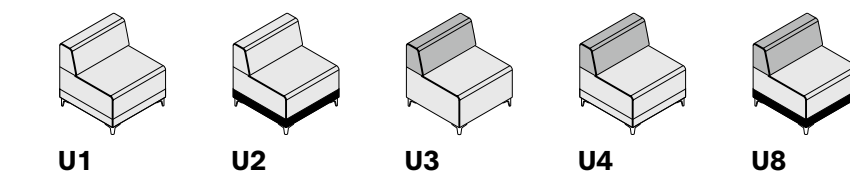

When pricing models with more than one fabric, the higher grade fabric will determine the overall grade of the specific product.

6. Upholstery

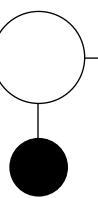

Upholstery

See [general information section](#) for details on textile program and COM/COL information.

Share will develop comfort wrinkles over time. The extent of these wrinkles is determined by the fabric specified.

Share

CHAIR: THREE-SEATER, LOUNGE HEIGHT

Textile Upholstery Grades

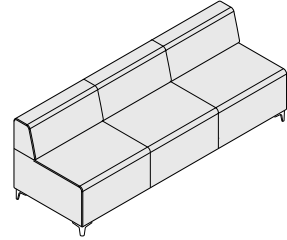
TITLE	SERIES	TYPE	SEAT	UPH	DIMENSIONS	YDG	COM	A	B	C	D	E	F	G	H	I	J	K	L	M	
Chair, Three-Seater, Lounge Height 	Standard Upholstery	SH	11	36	84W x 28D x 29H	8.5	5,065	5,782	6,176	6,563	6,958	7,346	7,777	8,209	8,715	9,369	10,152	10,476	11,220	11,839	
	Mono-Color Waterline	SH	11	36	U1	84W x 28D x 29H	8.5	5,450	6,166	6,557	6,951	7,339	7,733	8,163	8,595	9,101	9,754	10,536	10,861	11,604	12,224
	Dual-Color Waterline	SH	11	36	U2	84W x 28D x 29H	7.3 above Waterline 1.6 below Waterline	5,450	6,198	6,609	7,019	7,429	7,838	8,290	8,740	9,273	9,955	10,774	11,116	11,893	12,543
	No Waterline Back & Seat	SH	11	36	U3	84W x 28D x 29H	3.6 Back 4.9 Seat	5,065	5,782	6,176	6,563	6,958	7,346	7,777	8,209	8,715	9,369	10,152	10,476	11,220	11,839
	Waterline Back & Seat	SH	11	36	U4	84W x 28D x 29H	3.6 Back 4.9 Seat/below Waterline	5,450	6,166	6,557	6,951	7,339	7,733	8,163	8,595	9,101	9,754	10,536	10,861	11,604	12,224
	Triple-Back & Seat & Waterline	SH	11	36	U8	84W x 28D x 29H	1.6 below Waterline 3.6 Back 3.7 Seat/above Waterline	5,450	6,198	6,609	7,019	7,429	7,838	8,290	8,740	9,273	9,955	10,774	11,116	11,893	12,543

To Order Select Below

1. Series/Type/Seat

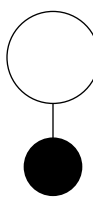

SH1136

Share
Chair, Three-Seater,
Lounge Height

2. Leg

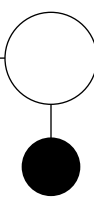

Leg

- L1 CORNER LEG, ADJ. PLASTIC GLIDES
- L2 ROUND LEG, ADJ. PLASTIC GLIDES
- L3 WOOD LEG

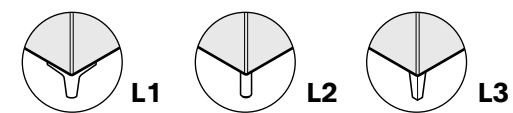

Mobility

The round leg glide has a larger diameter (1") than the corner leg for easier sliding on low pile carpet. Stylex is not responsible for damage to carpeting or floors.

3. Leg Finish

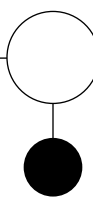

Standard Powder Coated Metal

- BL BLUE
- BM BLACK MATTE
- CP CHAMPAGNE
- DB DARK BRONZE
- DG DARK GRAY
- DP DUSTY PINK
- DS DARK SAGE
- LG LIGHT GRAY
- LL LILAC GRAY
- LP LIGHT PISTACHIO
- LR LIPSTICK RED
- MB MIDNIGHT BLUE

- MG MEADOW GREEN
- MK MILK
- MS METALLIC SILVER
- NK NICKEL
- OC OCHRE
- PY PALE YELLOW
- RO RED ORANGE
- RR RUSTY RED
- SB SOFT BLUE
- SD SAND
- TC TERRACOTTA
- TP TAUPE

4. Options

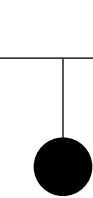

Polished Aluminum

- AL POLISHED ALUMINUM

Wood Finish +224

- 81 WHITE OAK
- 83 NATURAL MAPLE
- 85 WALNUT

Custom Color Match

- 09 CUSTOM COLOR

Per order per color - 20 chair minimum.
Contact customer service for details.

4. Options

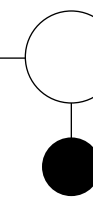

Ganging

- SG GANGING +53

Used to connect chairs to adjacent chairs or benches.

Power

- IN-SEAT POWER
C1X PORT W/10' CORD +452
- IN-SEAT POWER
C2X PORT W/20' CORD +485

See [page 7](#) for power port spec info.

Power Port Finish

Power ports can be finished in any standard powder coat available.

5. Upholstery Style



Upholstery Style

- U1 MONO-COLOR WATERLINE
- U2 DUAL-COLOR WATERLINE
- U3 SEAT & BACK, NO WATERLINE
- U4 SEAT & BACK, WITH WATERLINE
- U8 TRI-COLOR - SEAT, BACK & WATERLINE

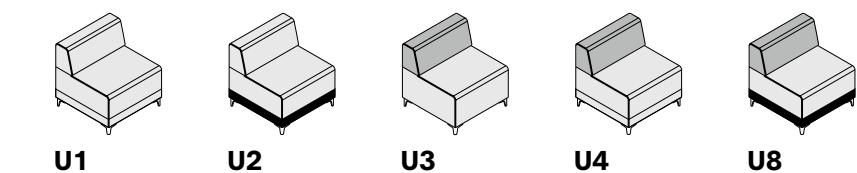

When pricing models with more than one fabric, the higher grade fabric will determine the overall grade of the specific product.

6. Upholstery

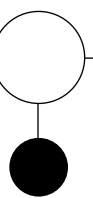

Upholstery

See [general information section](#) for details on textile program and COM/COL information.

Share will develop comfort wrinkles over time. The extent of these wrinkles is determined by the fabric specified.

Share

CHAIR: THREE-SEATER, TASK HEIGHT

Textile Upholstery Grades

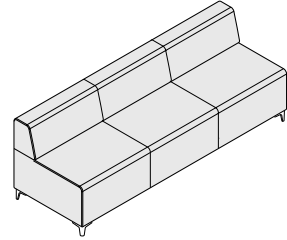
TITLE	SERIES	TYPE	SEAT	UPH	DIMENSIONS	YDG	COM	A	B	C	D	E	F	G	H	I	J	K	L	M	
Chair, Three-Seater, Task Height 	Standard Upholstery	SH	11	38	84W x 28D x 29H	8.5	5,065	5,782	6,176	6,563	6,958	7,346	7,777	8,209	8,715	9,369	10,152	10,476	11,220	11,839	
	Mono-Color Waterline	SH	11	38	U1	84W x 28D x 29H	8.5	5,450	6,166	6,557	6,951	7,339	7,733	8,163	8,595	9,101	9,754	10,536	10,861	11,604	12,224
	Dual-Color Waterline	SH	11	38	U2	84W x 28D x 29H	7.3 above Waterline 1.6 below Waterline	5,450	6,198	6,609	7,019	7,429	7,838	8,290	8,740	9,273	9,955	10,774	11,116	11,893	12,543
	No Waterline Back & Seat	SH	11	38	U3	84W x 28D x 29H	3.3 Back 5.2 Seat	5,065	5,782	6,176	6,563	6,958	7,346	7,777	8,209	8,715	9,369	10,152	10,476	11,220	11,839
	Waterline Back & Seat	SH	11	38	U4	84W x 28D x 29H	3.3 Back 5.2 Seat/below Waterline	5,450	6,166	6,557	6,951	7,339	7,733	8,163	8,595	9,101	9,754	10,536	10,861	11,604	12,224
	Triple-Back & Seat & Waterline	SH	11	38	U8	84W x 28D x 29H	1.6 below Waterline 3.3 Back 4 Seat/above Waterline	5,450	6,198	6,609	7,019	7,429	7,838	8,290	8,740	9,273	9,955	10,774	11,116	11,893	12,543

To Order Select Below

1. Series/Type/Seat

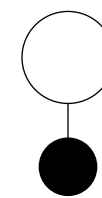

SH1138

Share
Chair, Three-Seater,
Task Height

2. Leg

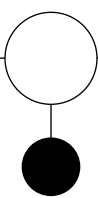

Leg

- L1 CORNER LEG, ADJ. PLASTIC GLIDES
- L2 ROUND LEG, ADJ. PLASTIC GLIDES
- L3 WOOD LEG

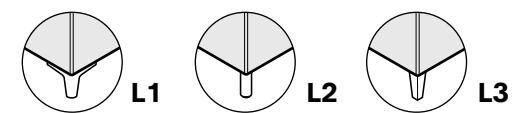

Mobility

The round leg glide has a larger diameter (1") than the corner leg for easier sliding on low pile carpet. Stylex is not responsible for damage to carpeting or floors.

3. Leg Finish

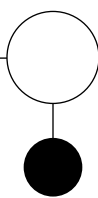

Standard Powder Coated Metal

- BL BLUE
- BM BLACK MATTE
- CP CHAMPAGNE
- DB DARK BRONZE
- DG DARK GRAY
- DP DUSTY PINK
- DS DARK SAGE
- LG LIGHT GRAY
- LL LILAC GRAY
- LP LIGHT PISTACHIO
- LR LIPSTICK RED
- MB MIDNIGHT BLUE

- MG MEADOW GREEN
- MK MILK
- MS METALLIC SILVER
- NK NICKEL
- OC OCHRE
- PY PALE YELLOW
- RO RED ORANGE
- RR RUSTY RED
- SB SOFT BLUE
- SD SAND
- TC TERRACOTTA
- TP TAUPE

4. Options

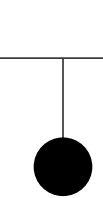

Polished Aluminum

- AL POLISHED ALUMINUM

Wood Finish +224

- 81 WHITE OAK
- 83 NATURAL MAPLE
- 85 WALNUT

Custom Color Match

- 09 CUSTOM COLOR

Per order per color - 20 chair minimum.
Contact customer service for details.

5. Upholstery Style

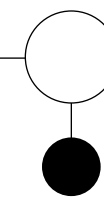

Ganging

- SG GANGING +53

Used to connect chairs to adjacent chairs or benches.

Power

- IN-SEAT POWER
C1X PORT W/10' CORD +452
- IN-SEAT POWER
C2X PORT W/20' CORD +485

See [page 7](#) for power port spec info.

Power Port Finish

Power ports can be finished in any standard powder coat available.

6. Upholstery

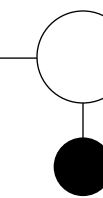

Upholstery Style

- U1 MONO-COLOR WATERLINE
- U2 DUAL-COLOR WATERLINE
- U3 SEAT & BACK, NO WATERLINE
- U4 SEAT & BACK, WITH WATERLINE
- U8 TRI-COLOR - SEAT, BACK & WATERLINE

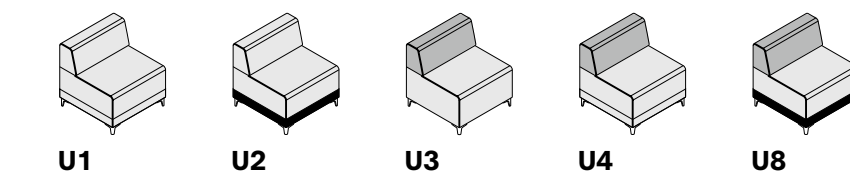

When pricing models with more than one fabric, the higher grade fabric will determine the overall grade of the specific product.

Upholstery

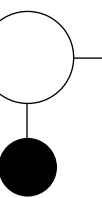

Upholstery

See [general information section](#) for details on textile program and COM/COL information.

Share will develop comfort wrinkles over time. The extent of these wrinkles is determined by the fabric specified.

Share

CHAIR: THREE-SEATER, BANQUETTE HEIGHT

Textile Upholstery Grades

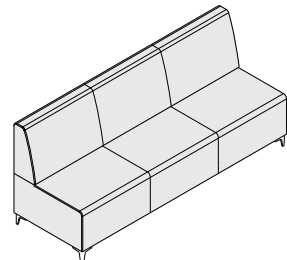
TITLE	SERIES	TYPE	SEAT	UPH	DIMENSIONS	YDG	COM	A	B	C	D	E	F	G	H	I	J	K	L	M
 <p>Chair, Three-Seater, Banquette Height</p>	Standard Upholstery	SH	71	38	84W x 28D x 36H	9.2	5,958	6,739	7,165	7,575	8,002	8,426	8,891	9,359	9,907	10,618	11,467	11,846	12,647	13,242
	Mono-Color Waterline	SH	71	38	84W x 28D x 36H	9.1	6,225	7,000	7,420	7,826	8,247	8,667	9,128	9,588	10,132	10,837	11,676	12,035	12,832	13,418
	Dual-Color Waterline	SH	71	38	84W x 28D x 36H	8 above Waterline 1.6 below Waterline	6,225	7,041	7,485	7,913	8,357	8,800	9,285	9,775	10,347	11,091	11,976	12,368	13,208	13,826
	No Waterline Back & Seat	SH	71	38	84W x 28D x 36H	4 Back 5.1 Seat	5,958	6,739	7,165	7,575	8,002	8,426	8,891	9,359	9,907	10,618	11,467	11,846	12,647	13,242
	Waterline Back & Seat	SH	71	38	84W x 28D x 36H	4 Back 5.2 Seat/below Waterline	6,225	7,000	7,420	7,826	8,247	8,667	9,128	9,588	10,132	10,837	11,676	12,035	12,832	13,418
	Triple-Back & Seat & Waterline	SH	71	38	84W x 28D x 36H	1.6 below Waterline 4 Back 4 Seat/above Waterline	6,225	7,041	7,485	7,913	8,357	8,800	9,285	9,775	10,347	11,091	11,976	12,368	13,208	13,826

To Order Select Below

1. Series/Type/Seat

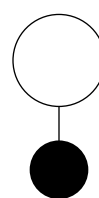

SH7138

**Share
Chair, Three-Seater,
Banquette Height**

2. Leg

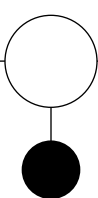

Leg

L1 CORNER LEG, ADJ. PLASTIC GLIDES

L2 ROUND LEG, ADJ. PLASTIC GLIDES

L3 WOOD LEG

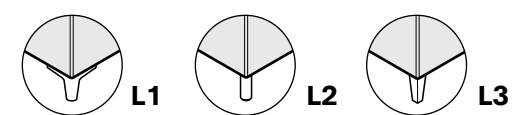

Mobility

The round leg glide has a larger diameter (1") than the corner leg for easier sliding on low pile carpet. Stylex is not responsible for damage to carpeting or floors.

3. Leg Finish

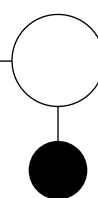

Standard Powder Coated Metal

BL BLUE

BM BLACK MATTE

CP CHAMPAGNE

DB DARK BRONZE

DG DARK GRAY

DP DUSTY PINK

DS DARK SAGE

LG LIGHT GRAY

LL LILAC GRAY

LP LIGHT PISTACHIO

LR LIPSTICK RED

MB MIDNIGHT BLUE

MG MEADOW GREEN

MK MILK

MS METALLIC SILVER

NK NICKEL

OC OCHRE

PY PALE YELLOW

RO RED ORANGE

RR RUSTY RED

SB SOFT BLUE

SD SAND

TC TERRACOTTA

TP TAUPE

4. Options

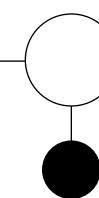

Ganging

SG GANGING **+53**

Used to connect chairs to adjacent chairs or benches.

Power

IN-SEAT POWER
C1X PORT W/10' CORD **+452**

IN-SEAT POWER
C2X PORT W/20' CORD **+485**

See [page 7](#) for power port spec info.

Power Port Finish

Power ports can be finished in any standard powder coat available.

5. Upholstery Style

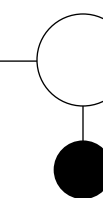

Upholstery Style

U1 MONO-COLOR WATERLINE

U2 DUAL-COLOR WATERLINE

U3 SEAT & BACK, NO WATERLINE

U4 SEAT & BACK, WITH WATERLINE

U8 TRI-COLOR - SEAT, BACK & WATERLINE

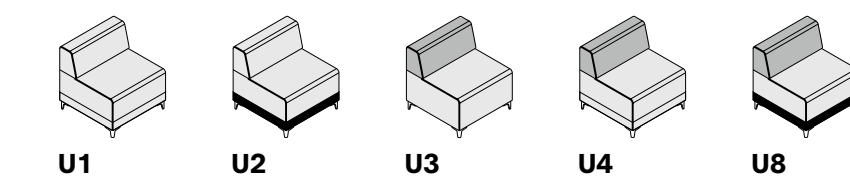

When pricing models with more than one fabric, the higher grade fabric will determine the overall grade of the specific product.

6. Upholstery

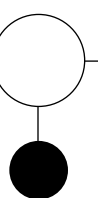

Upholstery

See [general information section](#) for details on textile program and COM/COL information.

Share will develop comfort wrinkles over time. The extent of these wrinkles is determined by the fabric specified.

Share

CHAIR: 90° CORNER, LOUNGE HEIGHT

Textile Upholstery Grades

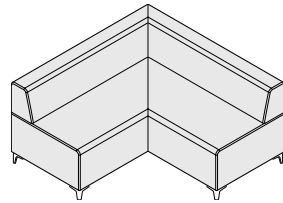
TITLE	SERIES	TYPE	SEAT	UPH	DIMENSIONS	YDG	COM	A	B	C	D	E	F	G	H	I	J	K	L	M
Chair, 90° Corner, Lounge Height 	Standard Upholstery	SH	12	26	56W x 28D x 29H	8	5,524	6,198	6,567	6,938	7,306	7,672	8,079	8,485	8,963	9,575	10,314	10,617	11,316	11,901
	Mono-Color Waterline	SH	12	26	56W x 28D x 29H	8.1	5,909	6,593	6,964	7,338	7,711	8,084	8,493	8,904	9,390	10,010	10,757	11,067	11,774	12,365
	Dual-Color Waterline	SH	12	26	56W x 28D x 29H	6.9 above Waterline 1.6 below Waterline	5,909	6,627	7,017	7,409	7,799	8,191	8,623	9,053	9,563	10,213	10,995	11,320	12,064	12,684
	No Waterline Back & Seat	SH	12	26	56W x 28D x 29H	3.6 Back 4.4 Seat	5,524	6,198	6,567	6,938	7,306	7,672	8,079	8,485	8,963	9,575	10,314	10,617	11,316	11,901
	Waterline Back & Seat	SH	12	26	56W x 28D x 29H	3.6 Back 4.4 Seat/below Waterline	5,909	6,593	6,964	7,338	7,711	8,084	8,493	8,904	9,390	10,010	10,757	11,002	11,701	12,286
	Triple-Back & Seat & Waterline	SH	12	26	56W x 28D x 29H	1.6 below Waterline 3.6 Back 3.3 Seat/above Waterline	5,909	6,627	7,017	7,409	7,799	8,191	8,623	9,053	9,563	10,213	10,995	11,320	12,064	12,684

To Order Select Below

1. Series/Type/Seat

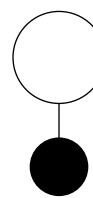

SH1226

Share
Chair, 90° Corner
Lounge Height

2. Leg

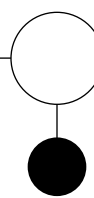

Leg

- L1 CORNER LEG, ADJ. PLASTIC GLIDES
- L2 ROUND LEG, ADJ. PLASTIC GLIDES
- L3 WOOD LEG

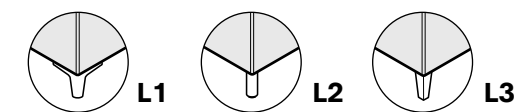

Mobility

The round leg glide has a larger diameter (1") than the corner leg for easier sliding on low pile carpet. Stylex is not responsible for damage to carpeting or floors.

3. Leg Finish

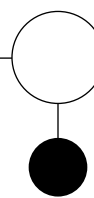

Standard Powder Coated Metal

- BL BLUE
- BM BLACK MATTE
- CP CHAMPAGNE
- DB DARK BRONZE
- DG DARK GRAY
- DP DUSTY PINK
- DS DARK SAGE
- LG LIGHT GRAY
- LL LILAC GRAY
- LP LIGHT PISTACHIO
- LR LIPSTICK RED
- MB MIDNIGHT BLUE

- MG MEADOW GREEN
- MK MILK
- MS METALLIC SILVER
- NK NICKEL
- OC OCHRE
- PY PALE YELLOW
- RO RED ORANGE
- RR RUSTY RED
- SB SOFT BLUE
- SD SAND
- TC TERRACOTTA
- TP TAUPE

4. Options

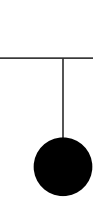

Polished Aluminum

- AL POLISHED ALUMINUM

Wood Finish +224

- 81 WHITE OAK
- 83 NATURAL MAPLE
- 85 WALNUT

Custom Color Match

- 09 CUSTOM COLOR

Per order per color - 20 chair minimum.
Contact customer service for details.

5. Upholstery Style

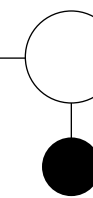

Ganging

- SG GANGING +53

Used to connect chairs to adjacent chairs or benches.

Power

- IN-SEAT POWER
C1X PORT W/10' CORD +452
- IN-SEAT POWER
C2X PORT W/20' CORD +485

See [page 7](#) for power port spec info.

Power Port Finish

Power ports can be finished in any standard powder coat available.

6. Upholstery

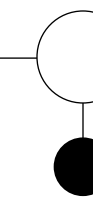

Upholstery Style

- U1 MONO-COLOR WATERLINE
- U2 DUAL-COLOR WATERLINE
- U3 SEAT & BACK, NO WATERLINE
- U4 SEAT & BACK, WITH WATERLINE
- U8 TRI-COLOR - SEAT, BACK & WATERLINE

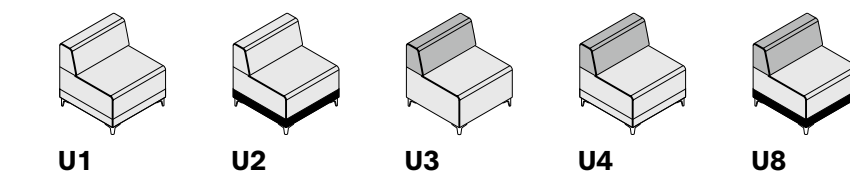

When pricing models with more than one fabric, the higher grade fabric will determine the overall grade of the specific product.

Upholstery

See [general information section](#) for details on textile program and COM/COL information.

Share will develop comfort wrinkles over time. The extent of these wrinkles is determined by the fabric specified.

Share

CHAIR: 90° CORNER, TASK HEIGHT

Textile Upholstery Grades

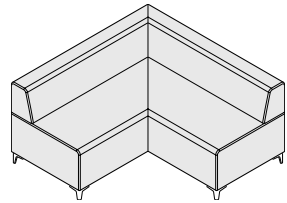
TITLE	SERIES	TYPE	SEAT	UPH	DIMENSIONS	YDG	COM	A	B	C	D	E	F	G	H	I	J	K	L	M	
Chair, 90° Corner, Task Height 	Standard Upholstery	SH	12	28	56W x 28D x 29H	8.5	5,524	6,244	6,636	7,026	7,417	7,811	8,238	8,668	9,175	9,829	10,611	10,936	11,679	12,299	
	Mono-Color Waterline	SH	12	28	U1	56W x 28D x 29H	8.5	5,909	6,627	7,017	7,409	7,799	8,191	8,623	9,053	9,563	10,213	10,995	11,320	12,064	12,684
	Dual-Color Waterline	SH	12	28	U2	56W x 28D x 29H	7.4 above Waterline 1.6 below Waterline	5,909	6,666	7,081	7,497	7,911	8,326	8,783	9,237	9,776	10,466	11,293	11,640	12,426	13,082
	No Waterline Back & Seat	SH	12	28	U3	56W x 28D x 29H	3.7 Back 4.8 Seat	5,524	6,244	6,636	7,026	7,417	7,811	8,238	8,668	9,175	9,829	10,611	10,936	11,679	12,299
	Waterline Back & Seat	SH	12	28	U4	56W x 28D x 29H	3.7 Back 4.8 Seat/below Waterline	5,909	6,627	7,017	7,409	7,799	8,191	8,623	9,053	9,563	10,213	10,995	11,320	12,064	12,684
	Triple-Back & Seat & Waterline	SH	12	28	U8	56W x 28D x 29H	1.6 below Waterline 3.7 Back 3.7 Seat/above Waterline	5,909	6,666	7,081	7,497	7,911	8,326	8,783	9,237	9,776	10,466	11,293	11,640	12,426	13,082

To Order Select Below

1. Series/Type/Seat

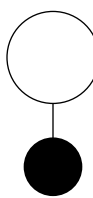

SH1228

Share
Chair, 90° Corner
Task Height

2. Leg

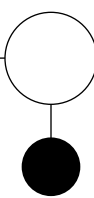

Leg

- L1 CORNER LEG, ADJ. PLASTIC GLIDES
- L2 ROUND LEG, ADJ. PLASTIC GLIDES
- L3 WOOD LEG

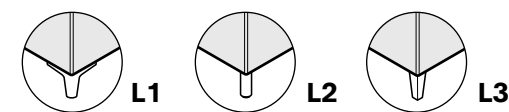

Mobility

The round leg glide has a larger diameter (1") than the corner leg for easier sliding on low pile carpet. Stylex is not responsible for damage to carpeting or floors.

3. Leg Finish

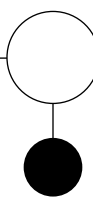

Standard Powder Coated Metal

- BL BLUE
- BM BLACK MATTE
- CP CHAMPAGNE
- DB DARK BRONZE
- DG DARK GRAY
- DP DUSTY PINK
- DS DARK SAGE
- LG LIGHT GRAY
- LL LILAC GRAY
- LP LIGHT PISTACHIO
- LR LIPSTICK RED
- MB MIDNIGHT BLUE

- MG MEADOW GREEN
- MK MILK
- MS METALLIC SILVER
- NK NICKEL
- OC OCHRE
- PY PALE YELLOW
- RO RED ORANGE
- RR RUSTY RED
- SB SOFT BLUE
- SD SAND
- TC TERRACOTTA
- TP TAUPE

4. Options

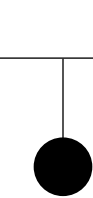

Polished Aluminum

- AL POLISHED ALUMINUM

Wood Finish +224

- 81 WHITE OAK
- 83 NATURAL MAPLE
- 85 WALNUT

Custom Color Match

- 09 CUSTOM COLOR

Per order per color - 20 chair minimum.
Contact customer service for details.

4. Options

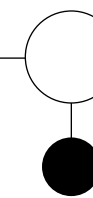

Ganging

- SG GANGING +53

Used to connect chairs to adjacent chairs or benches.

Power

- IN-SEAT POWER
C1X PORT W/10' CORD +452
- IN-SEAT POWER
C2X PORT W/20' CORD +485

See [page 7](#) for power port spec info.

Power Port Finish

Power ports can be finished in any standard powder coat available.

5. Upholstery Style

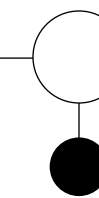

Upholstery Style

- U1 MONO-COLOR WATERLINE
- U2 DUAL-COLOR WATERLINE
- U3 SEAT & BACK, NO WATERLINE
- U4 SEAT & BACK, WITH WATERLINE
- U8 TRI-COLOR - SEAT, BACK & WATERLINE

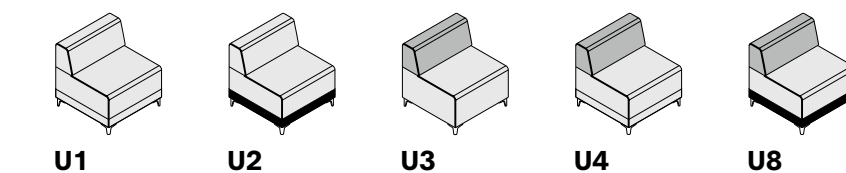

When pricing models with more than one fabric, the higher grade fabric will determine the overall grade of the specific product.

6. Upholstery

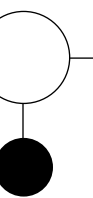

Upholstery

See [general information section](#) for details on textile program and COM/COL information.

Share will develop comfort wrinkles over time. The extent of these wrinkles is determined by the fabric specified.

Share

CHAIR: 90° CORNER, BANQUETTE HEIGHT

Textile Upholstery Grades

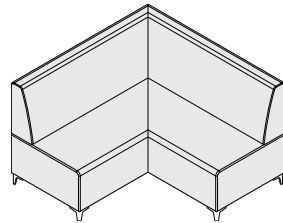
TITLE	SERIES	TYPE	SEAT	UPH	DIMENSIONS	YDG	COM	A	B	C	D	E	F	G	H	I	J	K	L	M	
Chair, 90° Corner, Banquette Height 	Standard Upholstery	SH	72	28	56W x 28D x 36H	9.2	6,717	7,497	7,925	8,336	8,759	9,185	9,651	10,116	10,664	11,378	12,226	12,575	13,380	13,970	
	Mono-Color Waterline	SH	72	28	U1	56W x 28D x 36H	9.1	7,101	7,875	8,296	8,702	9,122	9,541	10,002	10,463	11,006	11,710	12,551	12,876	13,674	14,259
	Dual-Color Waterline	SH	72	28	U2	56W x 28D x 36H	8.1 above Waterline 1.6 below Waterline	7,101	7,926	8,372	8,805	9,254	9,701	10,195	10,685	11,263	12,015	12,912	13,278	14,124	14,747
	No Waterline Back & Seat	SH	72	28	U3	56W x 28D x 36H	4.4 Back 4.8 Seat	6,717	7,497	7,925	8,336	8,759	9,185	9,651	10,116	10,664	11,378	12,226	12,575	13,380	13,970
	Waterline Back & Seat	SH	72	28	U4	56W x 28D x 36H	4.4 Back 4.9 Seat/below Waterline	7,101	7,875	8,296	8,702	9,122	9,541	10,002	10,463	11,006	11,710	12,551	12,876	13,674	14,259
	Triple-Back & Seat & Waterline	SH	72	28	U8	56W x 28D x 36H	1.6 below Waterline 4.4 Back 3.7 Seat/above Waterline	7,101	7,926	8,372	8,805	9,254	9,701	10,195	10,685	11,263	12,015	12,912	13,278	14,124	14,747

To Order Select Below

1. Series/Type/Seat

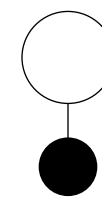

SH7228

Share
Chair, 90° Corner
Banquette Height

2. Leg

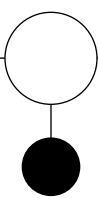

Leg

- L1 CORNER LEG, ADJ. PLASTIC GLIDES
- L2 ROUND LEG, ADJ. PLASTIC GLIDES
- L3 WOOD LEG

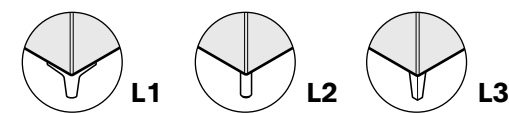

Mobility

The round leg glide has a larger diameter (1") than the corner leg for easier sliding on low pile carpet. Stylex is not responsible for damage to carpeting or floors.

3. Leg Finish

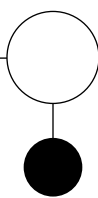

Standard Powder Coated Metal

- BL BLUE
- BM BLACK MATTE
- CP CHAMPAGNE
- DB DARK BRONZE
- DG DARK GRAY
- DP DUSTY PINK
- DS DARK SAGE
- LG LIGHT GRAY
- LL LILAC GRAY
- LP LIGHT PISTACHIO
- LR LIPSTICK RED
- MB MIDNIGHT BLUE

- MG MEADOW GREEN
- MK MILK
- MS METALLIC SILVER
- NK NICKEL
- OC OCHRE
- PY PALE YELLOW
- RO RED ORANGE
- RR RUSTY RED
- SB SOFT BLUE
- SD SAND
- TC TERRACOTTA
- TP TAUPE

4. Options

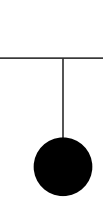

Polished Aluminum

- AL POLISHED ALUMINUM

Wood Finish +224

- 81 WHITE OAK
- 83 NATURAL MAPLE
- 85 WALNUT

Custom Color Match

- 09 CUSTOM COLOR

Per order per color - 20 chair minimum.
Contact customer service for details.

4. Options

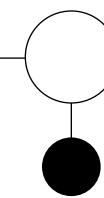

Ganging

- SG GANGING **+53**

Used to connect chairs to adjacent chairs or benches.

Power

- IN-SEAT POWER
C1X PORT W/10' CORD **+452**
- IN-SEAT POWER
C2X PORT W/20' CORD **+485**

See [page 7](#) for power port spec info.

Power Port Finish

Power ports can be finished in any standard powder coat available.

5. Upholstery Style

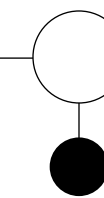

Upholstery Style

- U1 MONO-COLOR WATERLINE
- U2 DUAL-COLOR WATERLINE
- U3 SEAT & BACK, NO WATERLINE
- U4 SEAT & BACK, WITH WATERLINE
- U8 TRI-COLOR - SEAT, BACK & WATERLINE

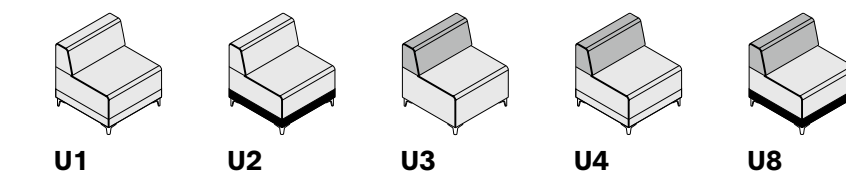

When pricing models with more than one fabric, the higher grade fabric will determine the overall grade of the specific product.

6. Upholstery

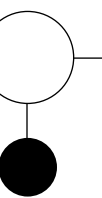

Upholstery

See [general information section](#) for details on textile program and COM/COL information.

Share will develop comfort wrinkles over time. The extent of these wrinkles is determined by the fabric specified.

Share

CHAIR: 120° CORNER, LOUNGE HEIGHT

Textile Upholstery Grades

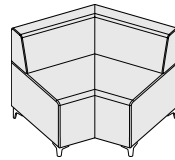
TITLE	SERIES	TYPE	SEAT	UPH	DIMENSIONS	YDG	COM	A	B	C	D	E	F	G	H	I	J	K	L	M
	Standard Upholstery	SH	12	46	42.5W x 28D x 29H	4.1	3,716	4,064	4,253	4,437	4,627	4,814	5,022	5,232	5,476	5,793	6,172	6,326	6,684	6,984
	Mono-Color Waterline	SH	12	46	42.5W x 28D x 29H	3.8	3,983	4,305	4,480	4,650	4,829	5,002	5,195	5,387	5,615	5,909	6,262	6,402	6,735	7,012
	Dual-Color Waterline	SH	12	46	42.5W x 28D x 29H	3.4 above Waterline 0.8 below Waterline	3,983	4,341	4,535	4,722	4,917	5,111	5,324	5,537	5,786	6,112	6,501	6,657	7,024	7,331
	No Waterline Back & Seat	SH	12	46	42.5W x 28D x 29H	1.7 Back 2.4 Seat	3,716	4,064	4,253	4,437	4,627	4,814	5,022	5,232	5,476	5,793	6,172	6,326	6,684	6,984
	Waterline Back & Seat	SH	12	46	42.5W x 28D x 29H	1.7 Back 2.4 Seat/below Waterline	3,983	4,305	4,480	4,650	4,829	5,002	5,195	5,387	5,615	5,909	6,262	6,594	6,951	7,251
	Triple-Back & Seat & Waterline	SH	12	46	42.5W x 28D x 29H	0.8 below Waterline 1.7 Back 1.7 Seat/above Waterline	3,983	4,341	4,535	4,722	4,917	5,111	5,324	5,537	5,786	6,112	6,501	6,657	7,024	7,331

To Order Select Below

1. Series/Type/Seat

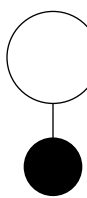

SH1246

Share
Chair, 120° Corner
Lounge Height

2. Leg

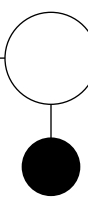

Leg

- L1 CORNER LEG, ADJ. PLASTIC GLIDES
- L2 ROUND LEG, ADJ. PLASTIC GLIDES
- L3 WOOD LEG

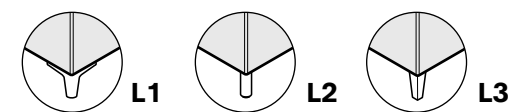

Mobility

The round leg glide has a larger diameter (1") than the corner leg for easier sliding on low pile carpet. Stylex is not responsible for damage to carpeting or floors.

3. Leg Finish

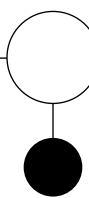

Standard Powder Coated Metal

- BL BLUE
- BM BLACK MATTE
- CP CHAMPAGNE
- DB DARK BRONZE
- DG DARK GRAY
- DP DUSTY PINK
- DS DARK SAGE
- LG LIGHT GRAY
- LL LILAC GRAY
- LP LIGHT PISTACHIO
- LR LIPSTICK RED
- MB MIDNIGHT BLUE

- MG MEADOW GREEN
- MK MILK
- MS METALLIC SILVER
- NK NICKEL
- OC OCHRE
- PY PALE YELLOW
- RO RED ORANGE
- RR RUSTY RED
- SB SOFT BLUE
- SD SAND
- TC TERRACOTTA
- TP TAUPE

4. Options

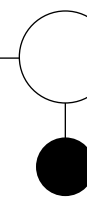

Ganging

- SG GANGING **+53**

Used to connect chairs to adjacent chairs or benches.

Power

- C1X IN-SEAT POWER PORT W/10' CORD **+452**
- C2X IN-SEAT POWER PORT W/20' CORD **+485**

See [page 7](#) for power port spec info.

Power Port Finish

Power ports can be finished in any standard powder coat available.

5. Upholstery Style

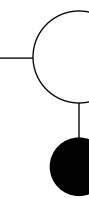

Upholstery Style

- U1 MONO-COLOR WATERLINE
- U2 DUAL-COLOR WATERLINE
- U3 SEAT & BACK, NO WATERLINE
- U4 SEAT & BACK, WITH WATERLINE
- U8 TRI-COLOR - SEAT, BACK & WATERLINE

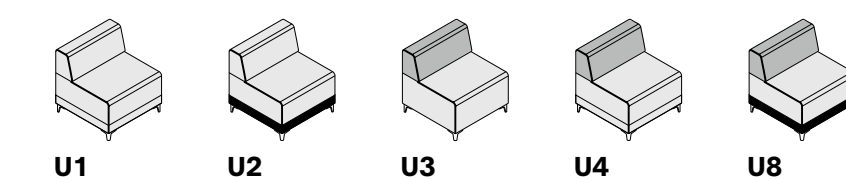

When pricing models with more than one fabric, the higher grade fabric will determine the overall grade of the specific product.

6. Upholstery

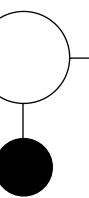

Upholstery

See [general information section](#) for details on textile program and COM/COL information.

Share will develop comfort wrinkles over time. The extent of these wrinkles is determined by the fabric specified.

Share

CHAIR: 120° CORNER, TASK HEIGHT

Textile Upholstery Grades

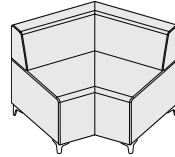
TITLE	SERIES	TYPE	SEAT	UPH	DIMENSIONS	YDG	COM	A	B	C	D	E	F	G	H	I	J	K	L	M	
Chair, 120° Corner, Task Height 	Standard Upholstery	SH	12	48		42.5W x 28D x 29H	4.1	3,716	4,064	4,253	4,437	4,627	4,814	5,022	5,232	5,476	5,793	6,172	6,326	6,684	6,984
	Mono-Color Waterline	SH	12	48	U1	42.5W x 28D x 29H	3.8	3,983	4,305	4,480	4,650	4,829	5,002	5,195	5,387	5,615	5,909	6,262	6,402	6,735	7,012
	Dual-Color Waterline	SH	12	48	U2	42.5W x 28D x 29H	3.5 above Waterline 0.8 below Waterline	3,983	4,341	4,535	4,722	4,917	5,111	5,324	5,537	5,786	6,112	6,501	6,720	7,097	7,410
	No Waterline Back & Seat	SH	12	48	U3	42.5W x 28D x 29H	1.6 Back 2.5 Seat	3,716	4,064	4,253	4,437	4,627	4,814	5,022	5,232	5,476	5,793	6,172	6,326	6,684	6,984
	Waterline Back & Seat	SH	12	48	U4	42.5W x 28D x 29H	1.6 Back 2.5 Seat/below Waterline	3,983	4,305	4,480	4,650	4,829	5,002	5,195	5,387	5,615	5,909	6,262	6,594	6,951	7,251
	Triple-Back & Seat & Waterline	SH	12	48	U8	42.5W x 28D x 29H	0.8 below Waterline 1.6 Back 1.9 Seat/above Waterline	3,983	4,341	4,535	4,722	4,917	5,111	5,324	5,537	5,786	6,112	6,501	6,720	7,097	7,410

To Order Select Below

1. Series/Type/Seat

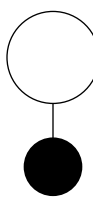

SH1248

Share
Chair, 120° Corner
Task Height

2. Leg

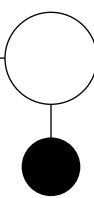

Leg

- L1 CORNER LEG, ADJ. PLASTIC GLIDES
- L2 ROUND LEG, ADJ. PLASTIC GLIDES
- L3 WOOD LEG

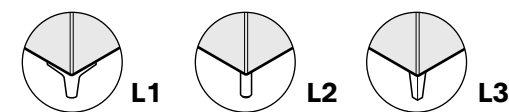

Mobility

The round leg glide has a larger diameter (1") than the corner leg for easier sliding on low pile carpet. Stylex is not responsible for damage to carpeting or floors.

3. Leg Finish

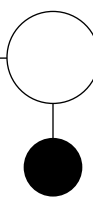

Standard Powder Coated Metal

- BL BLUE
- BM BLACK MATTE
- CP CHAMPAGNE
- DB DARK BRONZE
- DG DARK GRAY
- DP DUSTY PINK
- DS DARK SAGE
- LG LIGHT GRAY
- LL LILAC GRAY
- LP LIGHT PISTACHIO
- LR LIPSTICK RED
- MB MIDNIGHT BLUE

- MG MEADOW GREEN
- MK MILK
- MS METALLIC SILVER
- NK NICKEL
- OC OCHRE
- PY PALE YELLOW
- RO RED ORANGE
- RR RUSTY RED
- SB SOFT BLUE
- SD SAND
- TC TERRACOTTA
- TP TAUPE

4. Options

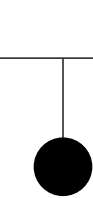

Polished Aluminum

- AL POLISHED ALUMINUM

Wood Finish +224

- 81 WHITE OAK
- 83 NATURAL MAPLE
- 85 WALNUT

Custom Color Match

- 09 CUSTOM COLOR

Per order per color - 20 chair minimum.
Contact customer service for details.

4. Options

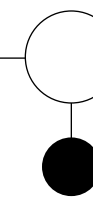

Ganging

- SG GANGING +53

Used to connect chairs to adjacent chairs or benches.

Power

- IN-SEAT POWER
C1X PORT W/10' CORD +452
- IN-SEAT POWER
C2X PORT W/20' CORD +485

See [page 7](#) for power port spec info.

Power Port Finish

Power ports can be finished in any standard powder coat available.

5. Upholstery Style

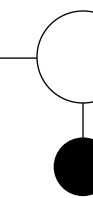

Upholstery Style

- U1 MONO-COLOR WATERLINE
- U2 DUAL-COLOR WATERLINE
- U3 SEAT & BACK, NO WATERLINE
- U4 SEAT & BACK, WITH WATERLINE
- U8 TRI-COLOR - SEAT, BACK & WATERLINE

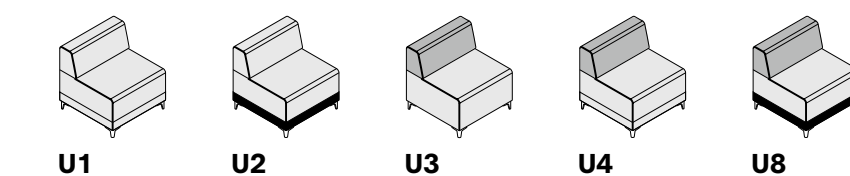

When pricing models with more than one fabric, the higher grade fabric will determine the overall grade of the specific product.

6. Upholstery

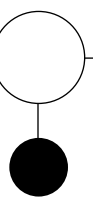

Upholstery

See [general information section](#) for details on textile program and COM/COL information.

Share will develop comfort wrinkles over time. The extent of these wrinkles is determined by the fabric specified.

Share

CHAIR: 120° CORNER, BANQUETTE HEIGHT

Textile Upholstery Grades

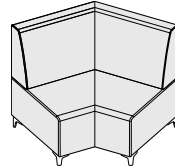
TITLE	SERIES	TYPE	SEAT	UPH	DIMENSIONS	YDG	COM	A	B	C	D	E	F	G	H	I	J	K	L	M	
 Chair, 120° Corner, Banquette Height	Standard Upholstery	SH	72	48	42.5W x 28D x 36H	5	4,314	4,735	4,967	5,191	5,423	5,652	5,906	6,160	6,457	6,845	7,307	7,770	8,223	8,560	
	Mono-Color Waterline	SH	72	48	U1	42.5W x 28D x 36H	4.7	4,581	4,981	5,195	5,409	5,622	5,841	6,078	6,315	6,596	6,961	7,395	7,830	8,257	8,570
	Dual-Color Waterline	SH	72	48	U2	42.5W x 28D x 36H	4.4 above Waterline 0.8 below Waterline	4,581	5,021	5,261	5,495	5,735	5,975	6,239	6,502	6,812	7,214	7,695	8,173	8,649	8,997
	No Waterline Back & Seat	SH	72	48	U3	42.5W x 28D x 36H	2.5 Back 2.5 Seat	4,314	4,735	4,967	5,191	5,423	5,652	5,906	6,160	6,457	6,845	7,307	7,770	8,223	8,560
	Waterline Back & Seat	SH	72	48	U4	42.5W x 28D x 36H	2.5 Back 2.2 Seat/below Waterline	4,581	4,981	5,195	5,409	5,622	5,841	6,078	6,315	6,596	6,961	7,395	7,830	8,257	8,570
	Triple-Back & Seat & Waterline	SH	72	48	U8	42.5W x 28D x 36H	0.8 below Waterline 2.5 Back 1.9 Seat/above Waterline	4,581	5,021	5,261	5,495	5,735	5,975	6,239	6,502	6,812	7,214	7,695	8,173	8,649	8,997

To Order Select Below

1. Series/Type/Seat

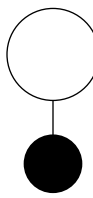

SH7248

Share
Chair, 120° Corner
Banquette Height

2. Leg

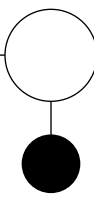

Leg

- L1 CORNER LEG, ADJ. PLASTIC GLIDES
- L2 ROUND LEG, ADJ. PLASTIC GLIDES
- L3 WOOD LEG

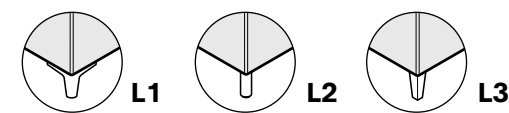

Mobility

The round leg glide has a larger diameter (1") than the corner leg for easier sliding on low pile carpet. Stylex is not responsible for damage to carpeting or floors.

3. Leg Finish

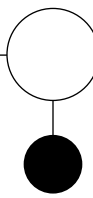

Standard Powder Coated Metal

- BL BLUE
- BM BLACK MATTE
- CP CHAMPAGNE
- DB DARK BRONZE
- DG DARK GRAY
- DP DUSTY PINK
- DS DARK SAGE
- LG LIGHT GRAY
- LL LILAC GRAY
- LP LIGHT PISTACHIO
- LR LIPSTICK RED
- MB MIDNIGHT BLUE

- MG MEADOW GREEN
- MK MILK
- MS METALLIC SILVER
- NK NICKEL
- OC OCHRE
- PY PALE YELLOW
- RO RED ORANGE
- RR RUSTY RED
- SB SOFT BLUE
- SD SAND
- TC TERRACOTTA
- TP TAUPE

4. Options

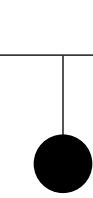

Polished Aluminum

- AL POLISHED ALUMINUM

Wood Finish +224

- 81 WHITE OAK
- 83 NATURAL MAPLE
- 85 WALNUT

Custom Color Match

- 09 CUSTOM COLOR

Per order per color - 20 chair minimum.
Contact customer service for details.

4. Options

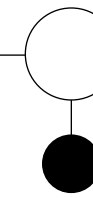

Ganging

- SG GANGING +53

Used to connect chairs to adjacent chairs or benches.

Power

- IN-SEAT POWER
C1X PORT W/10' CORD +452
- IN-SEAT POWER
C2X PORT W/20' CORD +485

See [page 7](#) for power port spec info.

Power Port Finish

Power ports can be finished in any standard powder coat available.

5. Upholstery Style



Upholstery Style

- U1 MONO-COLOR WATERLINE
- U2 DUAL-COLOR WATERLINE
- U3 SEAT & BACK, NO WATERLINE
- U4 SEAT & BACK, WITH WATERLINE
- U8 TRI-COLOR - SEAT, BACK & WATERLINE

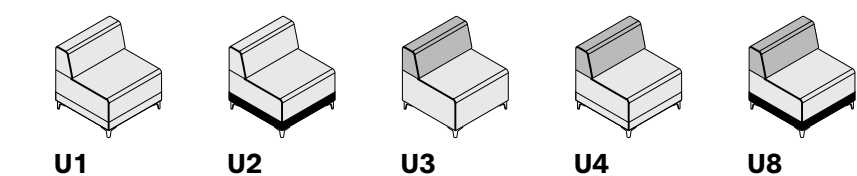

When pricing models with more than one fabric, the higher grade fabric will determine the overall grade of the specific product.

6. Upholstery

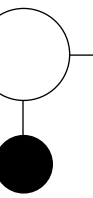

Upholstery

See [general information section](#) for details on textile program and COM/COL information.

Share will develop comfort wrinkles over time. The extent of these wrinkles is determined by the fabric specified.

Share

CHAIR: 30° INSIDE CURVED, LOUNGE HEIGHT

Textile Upholstery Grades

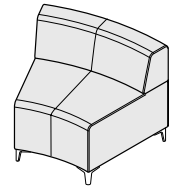
TITLE	SERIES	TYPE	SEAT	UPH	DIMENSIONS	YDG	COM	A	B	C	D	E	F	G	H	I	J	K	L	M	
 Chair, 30 Inside Curved, Lounge Height	Standard Upholstery	SH	14	56	35W x 28D x 29H	3.8	2,627	2,944	3,115	3,279	3,451	3,623	3,815	4,001	4,223	4,513	4,855	4,998	5,325	5,657	
	Mono-Color Waterline	SH	14	56	U1	35W x 28D x 29H	3.8	2,822	3,139	3,307	3,475	3,648	3,821	4,008	4,196	4,417	4,707	5,049	5,188	5,512	5,843
	Dual-Color Waterline	SH	14	56	U2	35W x 28D x 29H	3.3 above Waterline 0.8 below Waterline	2,822	3,163	3,348	3,530	3,713	3,900	4,103	4,308	4,545	4,855	5,226	5,382	5,735	6,091
	No Waterline Back & Seat	SH	14	56	U3	35W x 28D x 29H	1.4 Back 2.4 Seat	2,627	2,944	3,115	3,279	3,451	3,623	3,815	4,001	4,223	4,513	4,855	4,998	5,325	5,657
	Waterline Back & Seat	SH	14	56	U4	35W x 28D x 29H	1.2 Back 1.6 Seat/below Waterline	2,822	3,139	3,307	3,475	3,648	3,821	4,008	4,196	4,417	4,707	5,049	5,188	5,512	5,843
	Triple-Back & Seat & Waterline	SH	14	56	U8	35W x 28D x 29H	0.8 below Waterline 1.2 Back 1.6 Seat/above Waterline	2,822	3,163	3,348	3,530	3,713	3,900	4,103	4,308	4,545	4,855	5,226	5,382	5,735	6,091

To Order Select Below

1. Series/Type/Seat

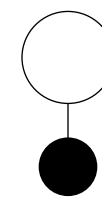

SH1456

Share
Chair, 30° Inside Curved,
Lounge Height

2. Leg

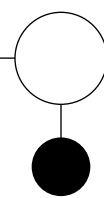

Leg

- L1 CORNER LEG, ADJ. PLASTIC GLIDES
- L2 ROUND LEG, ADJ. PLASTIC GLIDES
- L3 WOOD LEG

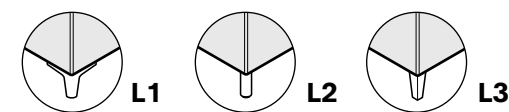

Mobility

The round leg glide has a larger diameter (1") than the corner leg for easier sliding on low pile carpet. Stylex is not responsible for damage to carpeting or floors.

3. Leg Finish

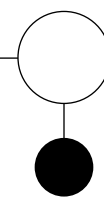

Standard Powder Coated Metal

- BL BLUE
- BM BLACK MATTE
- CP CHAMPAGNE
- DB DARK BRONZE
- DG DARK GRAY
- DP DUSTY PINK
- DS DARK SAGE
- LG LIGHT GRAY
- LL LILAC GRAY
- LP LIGHT PISTACHIO
- LR LIPSTICK RED
- MB MIDNIGHT BLUE

- MG MEADOW GREEN
- MK MILK
- MS METALLIC SILVER
- NK NICKEL
- OC OCHRE
- PY PALE YELLOW
- RO RED ORANGE
- RR RUSTY RED
- SB SOFT BLUE
- SD SAND
- TC TERRACOTTA
- TP TAUPE

4. Options

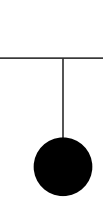

Polished Aluminum

- AL POLISHED ALUMINUM

Wood Finish +224

- 81 WHITE OAK
- 83 NATURAL MAPLE
- 85 WALNUT

Custom Color Match

- 09 CUSTOM COLOR

Per order per color - 20 chair minimum.
Contact customer service for details.

4. Options

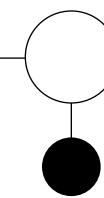

Ganging

- SG GANGING +53

Used to connect chairs to adjacent chairs or benches.

Power

- IN-SEAT POWER
C1X PORT W/10' CORD +452
- IN-SEAT POWER
C2X PORT W/20' CORD +485

See [page 7](#) for power port spec info.

Power Port Finish

Power ports can be finished in any standard powder coat available.

5. Upholstery Style

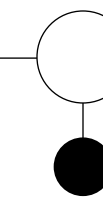

Upholstery Style

- U1 MONO-COLOR WATERLINE
- U2 DUAL-COLOR WATERLINE
- U3 SEAT & BACK, NO WATERLINE
- U4 SEAT & BACK, WITH WATERLINE
- U8 TRI-COLOR - SEAT, BACK & WATERLINE

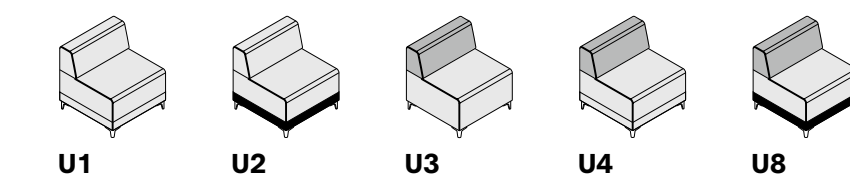

When pricing models with more than one fabric, the higher grade fabric will determine the overall grade of the specific product.

6. Upholstery

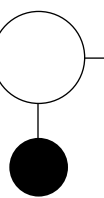

Upholstery

See [general information section](#) for details on textile program and COM/COL information.

Share will develop comfort wrinkles over time. The extent of these wrinkles is determined by the fabric specified.

Share

CHAIR: 30° INSIDE CURVED, TASK HEIGHT

Textile Upholstery Grades

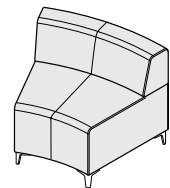
TITLE	SERIES	TYPE	SEAT	UPH	DIMENSIONS	YDG	COM	A	B	C	D	E	F	G	H	I	J	K	L	M	
 Chair, 30 Inside Curved, Task Height	Standard Upholstery	SH	14	58	35W x 28D x 29H	3.8	2,627	2,944	3,115	3,279	3,451	3,623	3,815	4,001	4,223	4,513	4,855	4,998	5,325	5,657	
	Mono-Color Waterline	SH	14	58	U1	35W x 28D x 29H	3.8	2,822	3,139	3,307	3,475	3,648	3,821	4,008	4,196	4,417	4,707	5,049	5,188	5,512	5,843
	Dual-Color Waterline	SH	14	58	U2	35W x 28D x 29H	3 above Waterline 0.8 below Waterline	2,822	3,139	3,307	3,475	3,648	3,821	4,008	4,196	4,417	4,707	5,049	5,188	5,512	5,843
	No Waterline Back & Seat	SH	14	58	U3	35W x 28D x 29H	1.4 Back 2.4 Seat	2,627	2,944	3,115	3,279	3,451	3,623	3,815	4,001	4,223	4,513	4,855	4,998	5,325	5,657
	Waterline Back & Seat	SH	14	58	U4	35W x 28D x 29H	1.1 Back 1.7 Seat/below Waterline	2,822	3,139	3,307	3,475	3,648	3,821	4,008	4,196	4,417	4,707	5,049	5,188	5,512	5,843
	Triple-Back & Seat & Waterline	SH	14	58	U8	35W x 28D x 29H	0.8 below Waterline 1.1 Back 1.7 Seat/above Waterline	2,822	3,139	3,307	3,475	3,648	3,821	4,008	4,196	4,417	4,707	5,049	5,188	5,512	5,843

To Order Select Below

1. Series/Type/Seat

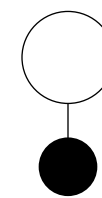

SH1458

Share
Chair, 30° Inside Curved
Task Height

2. Leg

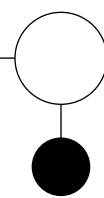

Leg

- L1 CORNER LEG, ADJ. PLASTIC GLIDES
- L2 ROUND LEG, ADJ. PLASTIC GLIDES
- L3 WOOD LEG

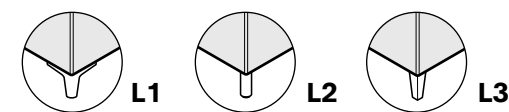

Mobility

The round leg glide has a larger diameter (1") than the corner leg for easier sliding on low pile carpet. Stylex is not responsible for damage to carpeting or floors.

3. Leg Finish

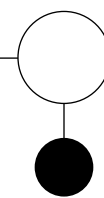

Standard Powder Coated Metal

- BL BLUE
- BM BLACK MATTE
- CP CHAMPAGNE
- DB DARK BRONZE
- DG DARK GRAY
- DP DUSTY PINK
- DS DARK SAGE
- LG LIGHT GRAY
- LL LILAC GRAY
- LP LIGHT PISTACHIO
- LR LIPSTICK RED
- MB MIDNIGHT BLUE

- MG MEADOW GREEN
- MK MILK
- MS METALLIC SILVER
- NK NICKEL
- OC OCHRE
- PY PALE YELLOW
- RO RED ORANGE
- RR RUSTY RED
- SB SOFT BLUE
- SD SAND
- TC TERRACOTTA
- TP TAUPE

4. Options

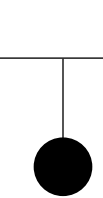

Polished Aluminum

- AL POLISHED ALUMINUM

Wood Finish +224

- 81 WHITE OAK
- 83 NATURAL MAPLE
- 85 WALNUT

Custom Color Match

- 09 CUSTOM COLOR

Per order per color - 20 chair minimum.
Contact customer service for details.

5. Upholstery Style

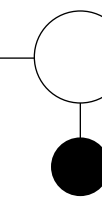

Ganging

- SG GANGING +53

Used to connect chairs to adjacent chairs or benches.

Power

- C1X IN-SEAT POWER PORT W/10' CORD +452

- C2X IN-SEAT POWER PORT W/20' CORD +485

See [page 7](#) for power port spec info.

Power Port Finish

Power ports can be finished in any standard powder coat available.

6. Upholstery

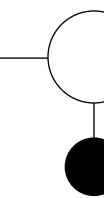

Upholstery Style

- U1 MONO-COLOR WATERLINE
- U2 DUAL-COLOR WATERLINE
- U3 SEAT & BACK, NO WATERLINE
- U4 SEAT & BACK, WITH WATERLINE
- U8 TRI-COLOR - SEAT, BACK & WATERLINE

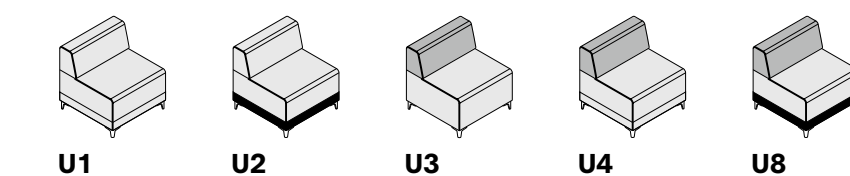

When pricing models with more than one fabric, the higher grade fabric will determine the overall grade of the specific product.

7. Upholstery

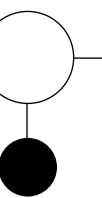

Upholstery

See [general information section](#) for details on textile program and COM/COL information.

Share will develop comfort wrinkles over time. The extent of these wrinkles is determined by the fabric specified.

Share

CHAIR: 30° OUTSIDE CURVED, LOUNGE HEIGHT

Textile Upholstery Grades

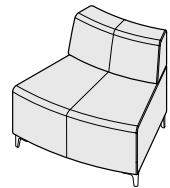
TITLE	SERIES	TYPE	SEAT	UPH	DIMENSIONS	YDG	COM	A	B	C	D	E	F	G	H	I	J	K	L	M	
 Chair, 30° Outside Curved, Lounge Height	Standard Upholstery	SH	15	56	35W x 28D x 29H	3.2	2,627	2,891	3,037	3,178	3,324	3,468	3,625	3,785	3,972	4,214	4,503	4,608	4,884	5,160	
	Mono-Color Waterline	SH	15	56	U1	35W x 28D x 29H	3.2	2,822	3,087	3,233	3,375	3,518	3,663	3,822	3,979	4,168	4,410	4,698	4,798	5,071	5,349
	Dual-Color Waterline	SH	15	56	U2	35W x 28D x 29H	2.7 above Waterline 0.8 below Waterline	2,822	3,115	3,271	3,425	3,583	3,742	3,915	4,088	4,293	4,557	4,874	4,993	5,293	5,596
	No Waterline Back & Seat	SH	15	56	U3	35W x 28D x 29H	1.54 Back 2.2 Seat	2,627	2,891	3,037	3,178	3,324	3,468	3,625	3,785	3,972	4,214	4,503	4,608	4,884	5,160
	Waterline Back & Seat	SH	15	56	U4	35W x 28D x 29H	1.4 Back 1.9 Seat/below Waterline	2,822	3,087	3,233	3,375	3,518	3,663	3,822	3,979	4,168	4,410	4,698	4,798	5,071	5,349
	Triple-Back & Seat & Waterline	SH	15	56	U8	35W x 28D x 29H	0.8 below Waterline 1.4 Back 1.9 Seat/above Waterline	2,822	3,115	3,271	3,425	3,583	3,742	3,915	4,088	4,293	4,557	4,874	4,993	5,293	5,596

To Order Select Below

1. Series/Type/Seat

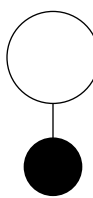

SH1556

Share
Chair, 30° Outside Curved,
Lounge Height

2. Leg

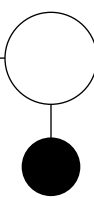

Leg

- L1 CORNER LEG, ADJ. PLASTIC GLIDES
- L2 ROUND LEG, ADJ. PLASTIC GLIDES
- L3 WOOD LEG

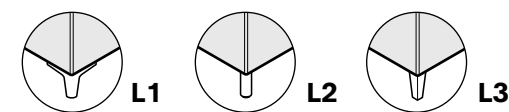

Mobility

The round leg glide has a larger diameter (1") than the corner leg for easier sliding on low pile carpet. Stylex is not responsible for damage to carpeting or floors.

3. Leg Finish

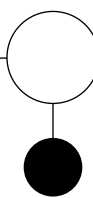

Standard Powder Coated Metal

- BL BLUE
- BM BLACK MATTE
- CP CHAMPAGNE
- DB DARK BRONZE
- DG DARK GRAY
- DP DUSTY PINK
- DS DARK SAGE
- LG LIGHT GRAY
- LL LILAC GRAY
- LP LIGHT PISTACHIO
- LR LIPSTICK RED
- MB MIDNIGHT BLUE

- MG MEADOW GREEN
- MK MILK
- MS METALLIC SILVER
- NK NICKEL
- OC OCHRE
- PY PALE YELLOW
- RO RED ORANGE
- RR RUSTY RED
- SB SOFT BLUE
- SD SAND
- TC TERRACOTTA
- TP TAUPE

4. Options

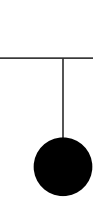

Polished Aluminum

- AL POLISHED ALUMINUM

Wood Finish +224

- 81 WHITE OAK
- 83 NATURAL MAPLE
- 85 WALNUT

Custom Color Match

- 09 CUSTOM COLOR

Per order per color - 20 chair minimum.
Contact customer service for details.

4. Options

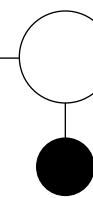

Ganging

- SG GANGING +53

Used to connect chairs to adjacent chairs or benches.

Power

- IN-SEAT POWER
C1X PORT W/10' CORD +452
- IN-SEAT POWER
C2X PORT W/20' CORD +485

See [page 7](#) for power port spec info.

Power Port Finish

Power ports can be finished in any standard powder coat available.

5. Upholstery Style

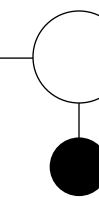

Upholstery Style

- U1 MONO-COLOR WATERLINE
- U2 DUAL-COLOR WATERLINE
- U3 SEAT & BACK, NO WATERLINE
- U4 SEAT & BACK, WITH WATERLINE
- U8 TRI-COLOR - SEAT, BACK & WATERLINE

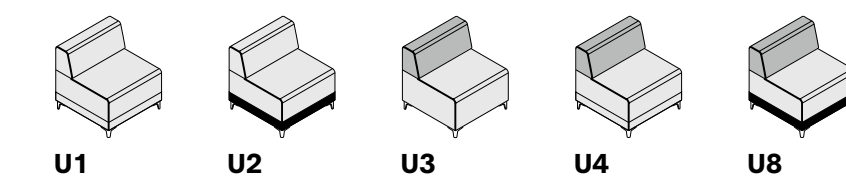

When pricing models with more than one fabric, the higher grade fabric will determine the overall grade of the specific product.

6. Upholstery

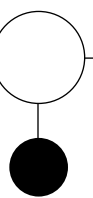

Upholstery

See [general information section](#) for details on textile program and COM/COL information.

Share will develop comfort wrinkles over time. The extent of these wrinkles is determined by the fabric specified.

Share

CHAIR: 30° OUTSIDE CURVED, TASK HEIGHT

Textile Upholstery Grades

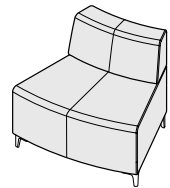
TITLE	SERIES	TYPE	SEAT	UPH	DIMENSIONS	YDG	COM	A	B	C	D	E	F	G	H	I	J	K	L	M	
 Chair, 30° Outside Curved, Task Height	Standard Upholstery	SH	15	58	35W x 28D x 29H	3.3	2,627	2,900	3,050	3,194	3,344	3,493	3,655	3,821	4,014	4,264	4,561	4,674	4,958	5,244	
	Mono-Color Waterline	SH	15	58	U1	35W x 28D x 29H	3.3	2,822	3,097	3,245	3,389	3,539	3,688	3,852	4,016	4,207	4,458	4,758	4,862	5,145	5,432
	Dual-Color Waterline	SH	15	58	U2	35W x 28D x 29H	2.5 above Waterline 0.8 below Waterline	2,822	3,097	3,245	3,389	3,539	3,688	3,852	4,016	4,207	4,458	4,758	4,862	5,145	5,432
	No Waterline Back & Seat	SH	15	58	U3	35W x 28D x 29H	1.54 Back 2.2 Seat	2,627	2,900	3,050	3,194	3,344	3,493	3,655	3,821	4,014	4,264	4,561	4,674	4,958	5,244
	Waterline Back & Seat	SH	15	58	U4	35W x 28D x 29H	1.4 Back 1.8 Seat/below Waterline	2,822	3,097	3,245	3,389	3,539	3,688	3,852	4,016	4,207	4,458	4,758	4,862	5,145	5,432
	Triple-Back & Seat & Waterline	SH	15	58	U8	35W x 28D x 29H	0.8 below Waterline 1.4 Back 1.8 Seat/above Waterline	2,822	3,097	3,245	3,389	3,539	3,688	3,852	4,016	4,207	4,458	4,758	4,862	5,145	5,432

To Order Select Below

1. Series/Type/Seat

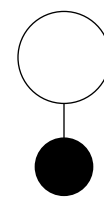

SH1558

Share
Chair, 30° Outside Curved,
Task Height

2. Leg

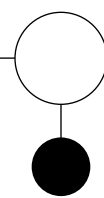

Leg

- L1 CORNER LEG, ADJ. PLASTIC GLIDES
- L2 ROUND LEG, ADJ. PLASTIC GLIDES
- L3 WOOD LEG

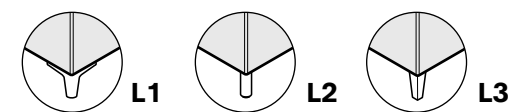

Mobility

The round leg glide has a larger diameter (1") than the corner leg for easier sliding on low pile carpet. Stylex is not responsible for damage to carpeting or floors.

3. Leg Finish

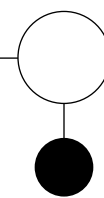

Standard Powder Coated Metal

- BL BLUE
- BM BLACK MATTE
- CP CHAMPAGNE
- DB DARK BRONZE
- DG DARK GRAY
- DP DUSTY PINK
- DS DARK SAGE
- LG LIGHT GRAY
- LL LILAC GRAY
- LP LIGHT PISTACHIO
- LR LIPSTICK RED
- MB MIDNIGHT BLUE

- MG MEADOW GREEN
- MK MILK
- MS METALLIC SILVER
- NK NICKEL
- OC OCHRE
- PY PALE YELLOW
- RO RED ORANGE
- RR RUSTY RED
- SB SOFT BLUE
- SD SAND
- TC TERRACOTTA
- TP TAUPE

4. Options

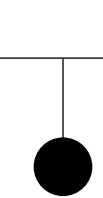

Polished Aluminum

- AL POLISHED ALUMINUM

Wood Finish +224

- 81 WHITE OAK
- 83 NATURAL MAPLE
- 85 WALNUT

Custom Color Match

- 09 CUSTOM COLOR

Per order per color - 20 chair minimum.
Contact customer service for details.

4. Options

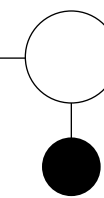

Ganging

- SG GANGING +53

Used to connect chairs to adjacent chairs or benches.

Power

- IN-SEAT POWER
C1X PORT W/10' CORD +452
- IN-SEAT POWER
C2X PORT W/20' CORD +485

See [page 7](#) for power port spec info.

Power Port Finish

Power ports can be finished in any standard powder coat available.

5. Upholstery Style

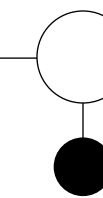

Upholstery Style

- U1 MONO-COLOR WATERLINE
- U2 DUAL-COLOR WATERLINE
- U3 SEAT & BACK, NO WATERLINE
- U4 SEAT & BACK, WITH WATERLINE
- U8 TRI-COLOR - SEAT, BACK & WATERLINE

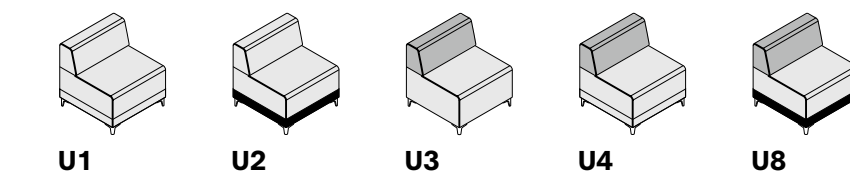

When pricing models with more than one fabric, the higher grade fabric will determine the overall grade of the specific product.

6. Upholstery

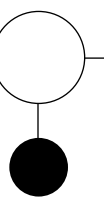

Upholstery

See [general information section](#) for details on textile program and COM/COL information.

Share will develop comfort wrinkles over time. The extent of these wrinkles is determined by the fabric specified.

Share

CHAIR: 60° INSIDE CURVED, LOUNGE HEIGHT

Textile Upholstery Grades

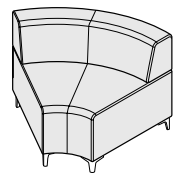
TITLE	SERIES	TYPE	SEAT	UPH	DIMENSIONS	YDG	COM	A	B	C	D	E	F	G	H	I	J	K	L	M	
 Chair, 60° Inside Curved, Lounge Height	Standard Upholstery	SH	14	66	39.75W x 28D x 29H	3.7	2,773	3,115	3,299	3,478	3,664	3,848	4,053	4,259	4,495	4,806	5,176	5,334	5,688	6,043	
	Mono-Color Waterline	SH	14	66	U1	39.75W x 28D x 29H	3.7	2,968	3,307	3,495	3,675	3,859	4,045	4,248	4,453	4,691	5,000	5,373	5,523	5,874	6,231
	Dual-Color Waterline	SH	14	66	U2	39.75W x 28D x 29H	3.5 above Waterline 0.8 below Waterline	2,968	3,326	3,519	3,709	3,904	4,098	4,311	4,524	4,774	5,103	5,490	5,653	6,022	6,395
	No Waterline Back & Seat	SH	14	66	U3	39.75W x 28D x 29H	1.5 Back 2.6 Seat	2,773	3,115	3,299	3,478	3,664	3,848	4,053	4,259	4,495	4,806	5,176	5,334	5,688	6,043
	Waterline Back & Seat	SH	14	66	U4	39.75W x 28D x 29H	1.1 Back 1.4 Seat/below Waterline	2,968	3,307	3,495	3,675	3,859	4,045	4,248	4,453	4,691	5,000	5,373	5,523	5,874	6,231
	Triple-Back & Seat & Waterline	SH	14	66	U8	39.75W x 28D x 29H	0.8 below Waterline 1.1 Back 1.4 Seat/above Waterline	2,968	3,326	3,519	3,709	3,904	4,098	4,311	4,524	4,774	5,103	5,490	5,653	6,022	6,395

To Order Select Below

1. Series/Type/Seat

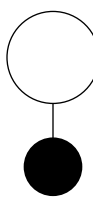

SH1466

Share
Chair, 60° Inside Curved,
Lounge Height

2. Leg

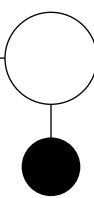

Leg

- L1 CORNER LEG, ADJ. PLASTIC GLIDES
- L2 ROUND LEG, ADJ. PLASTIC GLIDES
- L3 WOOD LEG

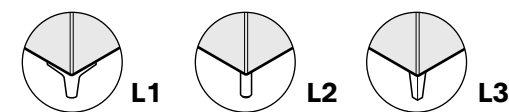

Mobility

The round leg glide has a larger diameter (1") than the corner leg for easier sliding on low pile carpet. Stylex is not responsible for damage to carpeting or floors.

3. Leg Finish

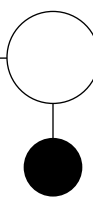

Standard Powder Coated Metal

- BL BLUE
- BM BLACK MATTE
- CP CHAMPAGNE
- DB DARK BRONZE
- DG DARK GRAY
- DP DUSTY PINK
- DS DARK SAGE
- LG LIGHT GRAY
- LL LILAC GRAY
- LP LIGHT PISTACHIO
- LR LIPSTICK RED
- MB MIDNIGHT BLUE

- MG MEADOW GREEN
- MK MILK
- MS METALLIC SILVER
- NK NICKEL
- OC OCHRE
- PY PALE YELLOW
- RO RED ORANGE
- RR RUSTY RED
- SB SOFT BLUE
- SD SAND
- TC TERRACOTTA
- TP TAUPE

4. Options

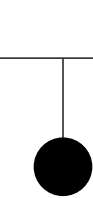

Polished Aluminum

- AL POLISHED ALUMINUM

Wood Finish +321

- 81 WHITE OAK
- 83 NATURAL MAPLE
- 85 WALNUT

Custom Color Match

- 09 CUSTOM COLOR

Per order per color - 20 chair minimum.
Contact customer service for details.

4. Options

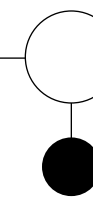

Ganging

- SG GANGING +53

Used to connect chairs to adjacent chairs or benches.

Power

- IN-SEAT POWER
C1X PORT W/10' CORD +452
- IN-SEAT POWER
C2X PORT W/20' CORD +485

See [page 7](#) for power port spec info.

Power Port Finish

Power ports can be finished in any standard powder coat available.

5. Upholstery Style

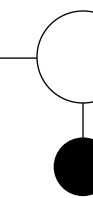

Upholstery Style

- U1 MONO-COLOR WATERLINE
- U2 DUAL-COLOR WATERLINE
- U3 SEAT & BACK, NO WATERLINE
- U4 SEAT & BACK, WITH WATERLINE
- U8 TRI-COLOR - SEAT, BACK & WATERLINE

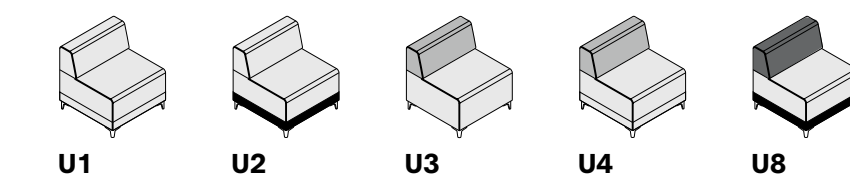

When pricing models with more than one fabric, the higher grade fabric will determine the overall grade of the specific product.

6. Upholstery

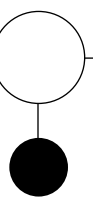

Upholstery

See [general information section](#) for details on textile program and COM/COL information.

Share will develop comfort wrinkles over time. The extent of these wrinkles is determined by the fabric specified.

Share

CHAIR: 60° INSIDE CURVED, TASK HEIGHT

Textile Upholstery Grades

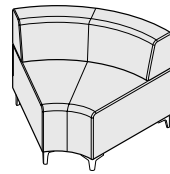
TITLE	SERIES	TYPE	SEAT	UPH	DIMENSIONS	YDG	COM	A	B	C	D	E	F	G	H	I	J	K	L	M	
 Chair, 60 Inside Curved, Task Height	Standard Upholstery	SH	14	68	39.75W x 28D x 29H	4.1	2,773	3,082	3,247	3,410	3,578	3,744	3,928	4,111	4,327	4,608	4,941	5,075	5,391	5,714	
	Mono-Color Waterline	SH	14	68	U1	39.75W x 28D x 29H	4.1	2,968	3,276	3,443	3,606	3,773	3,938	4,124	4,309	4,524	4,804	5,138	5,263	5,581	5,900
	Dual-Color Waterline	SH	14	68	U2	39.75W x 28D x 29H	3.8 above Waterline 0.8 below Waterline	2,968	3,350	3,558	3,760	3,968	4,177	4,405	4,633	4,900	5,250	5,665	6,081	6,491	6,908
	No Waterline Back & Seat	SH	14	68	U3	39.75W x 28D x 29H	1.3 Back 2.5 Seat	2,773	3,082	3,247	3,410	3,578	3,744	3,928	4,111	4,327	4,608	4,941	5,075	5,391	5,714
	Waterline Back & Seat	SH	14	68	U4	39.75W x 28D x 29H	1 Back 2 Seat/below Waterline	2,968	3,276	3,443	3,606	3,773	3,938	4,124	4,309	4,524	4,804	5,138	5,263	5,581	5,900
	Triple-Back & Seat & Waterline	SH	14	68	U8	39.75W x 28D x 29H	0.8 below Waterline 1 Back 2 Seat/above Waterline	2,968	3,350	3,558	3,760	3,968	4,177	4,405	4,633	4,900	5,250	5,665	6,081	6,491	6,908

To Order Select Below

1. Series/Type/Seat

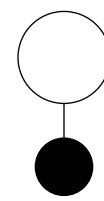

SH1468

Share
Chair, 60° Inside Curved
Task Height

2. Leg

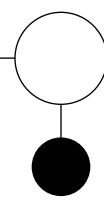

Leg

- L1 CORNER LEG, ADJ. PLASTIC GLIDES
- L2 ROUND LEG, ADJ. PLASTIC GLIDES
- L3 WOOD LEG

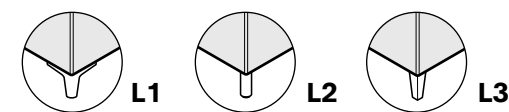

Mobility

The round leg glide has a larger diameter (1") than the corner leg for easier sliding on low pile carpet. Stylex is not responsible for damage to carpeting or floors.

3. Leg Finish

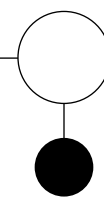

Standard Powder Coated Metal

- BL BLUE
- BM BLACK MATTE
- CP CHAMPAGNE
- DB DARK BRONZE
- DG DARK GRAY
- DP DUSTY PINK
- DS DARK SAGE
- LG LIGHT GRAY
- LL LILAC GRAY
- LP LIGHT PISTACHIO
- LR LIPSTICK RED
- MB MIDNIGHT BLUE

- MG MEADOW GREEN
- MK MILK
- MS METALLIC SILVER
- NK NICKEL
- OC OCHRE
- PY PALE YELLOW
- RO RED ORANGE
- RR RUSTY RED
- SB SOFT BLUE
- SD SAND
- TC TERRACOTTA
- TP TAUPE

4. Options

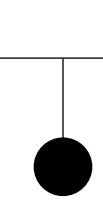

Polished Aluminum

- AL POLISHED ALUMINUM

Wood Finish +321

- 81 WHITE OAK
- 83 NATURAL MAPLE
- 85 WALNUT

Custom Color Match

- 09 CUSTOM COLOR

Per order per color - 20 chair minimum.
Contact customer service for details.

5. Upholstery Style

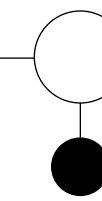

Ganging

- SG GANGING +53

Used to connect chairs to adjacent chairs or benches.

Power

- C1X IN-SEAT POWER PORT W/10' CORD +452
- C2X IN-SEAT POWER PORT W/20' CORD +485

See [page 7](#) for power port spec info.

Power Port Finish

Power ports can be finished in any standard powder coat available.

6. Upholstery

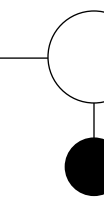

Upholstery Style

- U1 MONO-COLOR WATERLINE
- U2 DUAL-COLOR WATERLINE
- U3 SEAT & BACK, NO WATERLINE
- U4 SEAT & BACK, WITH WATERLINE
- U8 TRI-COLOR - SEAT, BACK & WATERLINE

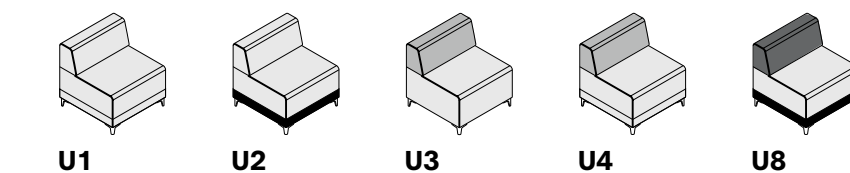

When pricing models with more than one fabric, the higher grade fabric will determine the overall grade of the specific product.

Upholstery

See [general information section](#) for details on textile program and COM/COL information.

Share will develop comfort wrinkles over time. The extent of these wrinkles is determined by the fabric specified.

Share

CHAIR: 60° OUTSIDE CURVED, LOUNGE HEIGHT

Textile Upholstery Grades

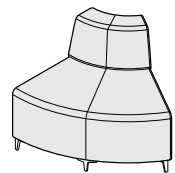
TITLE	SERIES	TYPE	SEAT	UPH	DIMENSIONS	YDG	COM	A	B	C	D	E	F	G	H	I	J	K	L	M	
Chair, 60° Outside Curved, Lounge Height 	Standard Upholstery	SH	15	66	39.75W x 28D x 29H	3.2	2,773	3,037	3,183	3,325	3,469	3,613	3,773	3,930	4,118	4,360	4,649	4,939	5,223	5,513	
	Mono-Color Waterline	SH	15	66	U1	39.75W x 28D x 29H	3.2	2,968	3,233	3,379	3,519	3,664	3,810	3,968	4,127	4,314	4,555	4,844	5,136	5,419	5,708
	Dual-Color Waterline	SH	15	66	U2	39.75W x 28D x 29H	2.4 above Waterline 0.8 below Waterline	2,968	3,233	3,379	3,519	3,664	3,810	3,968	4,127	4,314	4,555	4,844	5,136	5,419	5,708
	No Waterline Back & Seat	SH	15	66	U3	39.75W x 28D x 29H	1.65 Back 2.75 Seat	2,773	3,037	3,183	3,325	3,469	3,613	3,773	3,930	4,118	4,360	4,649	4,939	5,223	5,513
	Waterline Back & Seat	SH	15	66	U4	39.75W x 28D x 29H	1.5 Back 2 Seat/below Waterline	2,968	3,233	3,379	3,519	3,664	3,810	3,968	4,127	4,314	4,555	4,844	5,136	5,419	5,708
	Triple-Back & Seat & Waterline	SH	15	66	U8	39.75W x 28D x 29H	0.8 below Waterline 1.5 Back 2 Seat/above Waterline	2,968	3,233	3,379	3,519	3,664	3,810	3,968	4,127	4,314	4,555	4,844	5,136	5,419	5,708

To Order Select Below

1. Series/Type/Seat

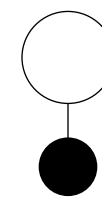

SH1566

Share
Chair, 60° Outside Curved, Lounge Height

2. Leg

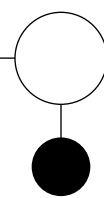

Leg

- L1 CORNER LEG, ADJ. PLASTIC GLIDES
- L2 ROUND LEG, ADJ. PLASTIC GLIDES
- L3 WOOD LEG

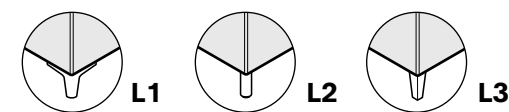

Mobility

The round leg glide has a larger diameter (1") than the corner leg for easier sliding on low pile carpet. Stylex is not responsible for damage to carpeting or floors.

3. Leg Finish

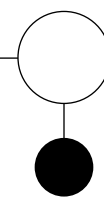

Standard Powder Coated Metal

- BL BLUE
- BM BLACK MATTE
- CP CHAMPAGNE
- DB DARK BRONZE
- DG DARK GRAY
- DP DUSTY PINK
- DS DARK SAGE
- LG LIGHT GRAY
- LL LILAC GRAY
- LP LIGHT PISTACHIO
- LR LIPSTICK RED
- MB MIDNIGHT BLUE

- MG MEADOW GREEN
- MK MILK
- MS METALLIC SILVER
- NK NICKEL
- OC OCHRE
- PY PALE YELLOW
- RO RED ORANGE
- RR RUSTY RED
- SB SOFT BLUE
- SD SAND
- TC TERRACOTTA
- TP TAUPE

4. Options

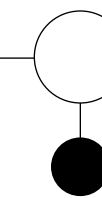

Ganging

- SG GANGING **+53**

Used to connect chairs to adjacent chairs or benches.

Power

- C1X IN-SEAT POWER PORT W/10' CORD **+452**
- C2X IN-SEAT POWER PORT W/20' CORD **+485**

See [page 7](#) for power port spec info.

Power Port Finish

Power ports can be finished in any standard powder coat available.

5. Upholstery Style

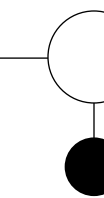

Upholstery Style

- U1 MONO-COLOR WATERLINE
- U2 DUAL-COLOR WATERLINE
- U3 SEAT & BACK, NO WATERLINE
- U4 SEAT & BACK, WITH WATERLINE
- U8 TRI-COLOR - SEAT, BACK & WATERLINE

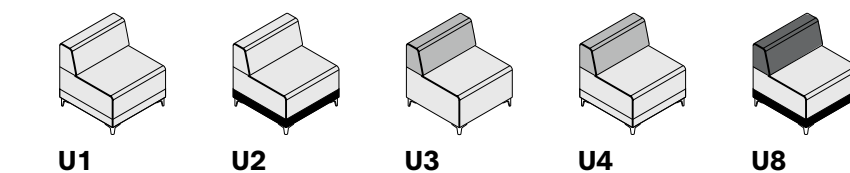

When pricing models with more than one fabric, the higher grade fabric will determine the overall grade of the specific product.

6. Upholstery

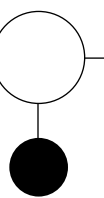

Upholstery

See [general information section](#) for details on textile program and COM/COL information.

Share will develop comfort wrinkles over time. The extent of these wrinkles is determined by the fabric specified.

Share

CHAIR: 60° OUTSIDE CURVED, TASK HEIGHT

Textile Upholstery Grades

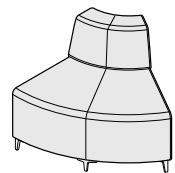
TITLE	SERIES	TYPE	SEAT	UPH	DIMENSIONS	YDG	COM	A	B	C	D	E	F	G	H	I	J	K	L	M	
Chair, 60° Outside Curved, Task Height 	Standard Upholstery	SH	15	68	39.75W x 28D x 29H	3.2	2,773	3,037	3,183	3,325	3,469	3,613	3,773	3,930	4,118	4,360	4,649	4,939	5,223	5,513	
	Mono-Color Waterline	SH	15	68	U1	39.75W x 28D x 29H	3.2	2,968	3,233	3,379	3,519	3,664	3,810	3,968	4,127	4,314	4,555	4,844	5,136	5,419	5,708
	Dual-Color Waterline	SH	15	68	U2	39.75W x 28D x 29H	2.8 above Waterline 0.8 below Waterline	2,968	3,267	3,432	3,588	3,750	3,914	4,091	4,271	4,481	4,755	5,079	5,404	5,726	6,051
	No Waterline Back & Seat	SH	15	68	U3	39.75W x 28D x 29H	1.54 Back 2.75 Seat	2,773	3,037	3,183	3,325	3,469	3,613	3,773	3,930	4,118	4,360	4,649	4,939	5,223	5,513
	Waterline Back & Seat	SH	15	68	U4	39.75W x 28D x 29H	1.4 Back 2.5 Seat/below Waterline	2,968	3,233	3,379	3,519	3,664	3,810	3,968	4,127	4,314	4,555	4,844	5,136	5,419	5,708
	Triple-Back & Seat & Waterline	SH	15	68	U8	39.75W x 28D x 29H	0.8 below Waterline 1.4 Back 2.5 Seat/above Waterline	2,968	3,267	3,432	3,588	3,750	3,914	4,091	4,271	4,481	4,755	5,079	5,404	5,726	6,051

To Order Select Below

1. Series/Type/Seat

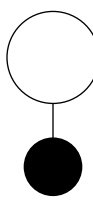

SH1568

Share
Chair, 60° Outside Curved,
Task Height

2. Leg

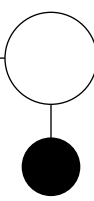

Leg

- L1 CORNER LEG, ADJ. PLASTIC GLIDES
- L2 ROUND LEG, ADJ. PLASTIC GLIDES
- L3 WOOD LEG

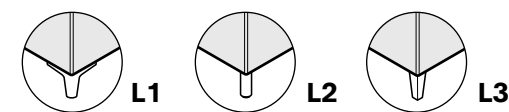

Mobility

The round leg glide has a larger diameter (1") than the corner leg for easier sliding on low pile carpet. Stylex is not responsible for damage to carpeting or floors.

3. Leg Finish

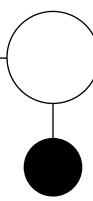

Standard Powder Coated Metal

- BL BLUE
- BM BLACK MATTE
- CP CHAMPAGNE
- DB DARK BRONZE
- DG DARK GRAY
- DP DUSTY PINK
- DS DARK SAGE
- LG LIGHT GRAY
- LL LILAC GRAY
- LP LIGHT PISTACHIO
- LR LIPSTICK RED
- MB MIDNIGHT BLUE

- MG MEADOW GREEN
- MK MILK
- MS METALLIC SILVER
- NK NICKEL
- OC OCHRE
- PY PALE YELLOW
- RO RED ORANGE
- RR RUSTY RED
- SB SOFT BLUE
- SD SAND
- TC TERRACOTTA
- TP TAUPE

4. Options

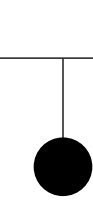

Polished Aluminum

- AL POLISHED ALUMINUM

Wood Finish +321

- 81 WHITE OAK
- 83 NATURAL MAPLE
- 85 WALNUT

Custom Color Match

- 09 CUSTOM COLOR

Per order per color - 20 chair minimum.
Contact customer service for details.

5. Upholstery Style

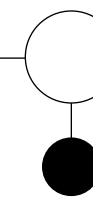

Ganging

- SG GANGING +53

Used to connect chairs to adjacent chairs or benches.

Power

- IN-SEAT POWER
C1X PORT W/10' CORD +452
- IN-SEAT POWER
C2X PORT W/20' CORD +485

See [page 7](#) for power port spec info.

Power Port Finish

Power ports can be finished in any standard powder coat available.

6. Upholstery

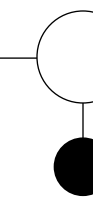

Upholstery Style

- U1 MONO-COLOR WATERLINE
- U2 DUAL-COLOR WATERLINE
- U3 SEAT & BACK, NO WATERLINE
- U4 SEAT & BACK, WITH WATERLINE
- U8 TRI-COLOR - SEAT, BACK & WATERLINE

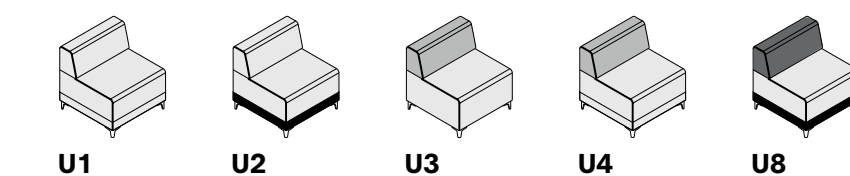

When pricing models with more than one fabric, the higher grade fabric will determine the overall grade of the specific product.

Upholstery

See [general information section](#) for details on textile program and COM/COL information.

Share will develop comfort wrinkles over time. The extent of these wrinkles is determined by the fabric specified.

Share

CHAIR: 90° INSIDE CURVED, LOUNGE HEIGHT

Textile Upholstery Grades

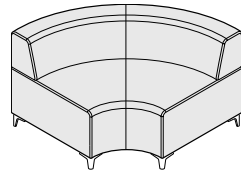
TITLE	SERIES	TYPE	SEAT	UPH	DIMENSIONS	YDG	COM	A	B	C	D	E	F	G	H	I	J	K	L	M
Chair, 90° Inside Curved, Lounge Height 	Standard Upholstery	SH	14	76	56.25W x 28D x 29H	5.6	3,648	4,112	4,368	4,612	4,865	5,118	5,396	5,673	6,003	6,425	6,935	7,154	7,632	8,119
	Mono-Color Waterline	SH	14	76	56.25W x 28D x 29H	5.6	3,844	4,310	4,561	4,807	5,061	5,313	5,593	5,871	6,196	6,622	7,127	7,341	7,821	8,308
	Dual-Color Waterline	SH	14	76	56.25W x 28D x 29H	5.3 above Waterline 0.8 below Waterline	3,844	4,350	4,627	4,895	5,170	5,445	5,746	6,051	6,406	6,870	7,422	7,666	8,190	8,720
	No Waterline Back & Seat	SH	14	76	56.25W x 28D x 29H	2.1 Back 3.5 Seat	3,648	4,112	4,368	4,612	4,865	5,118	5,396	5,673	6,003	6,425	6,935	7,154	7,632	8,119
	Waterline Back & Seat	SH	14	76	56.25W x 28D x 29H	1.5 Back 2.3 Seat/below Waterline	3,844	4,310	4,561	4,807	5,061	5,313	5,593	5,871	6,196	6,622	7,127	7,341	7,821	8,308
	Triple-Back & Seat & Waterline	SH	14	76	56.25W x 28D x 29H	1 below Waterline 1.5 Back 2.3 Seat/above Waterline	3,844	4,350	4,627	4,895	5,170	5,445	5,746	6,051	6,406	6,870	7,422	7,666	8,190	8,720

To Order Select Below

1. Series/Type/Seat

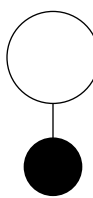

SH1476

Share
Chair, 90° Inside Curved,
Lounge Height

2. Leg

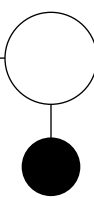

Leg

- L1 CORNER LEG, ADJ. PLASTIC GLIDES
- L2 ROUND LEG, ADJ. PLASTIC GLIDES
- L3 WOOD LEG

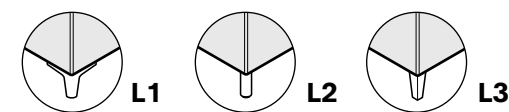

Mobility

The round leg glide has a larger diameter (1") than the corner leg for easier sliding on low pile carpet. Stylex is not responsible for damage to carpeting or floors.

3. Leg Finish

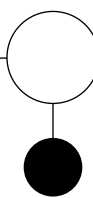

Standard Powder Coated Metal

- BL BLUE
- BM BLACK MATTE
- CP CHAMPAGNE
- DB DARK BRONZE
- DG DARK GRAY
- DP DUSTY PINK
- DS DARK SAGE
- LG LIGHT GRAY
- LL LILAC GRAY
- LP LIGHT PISTACHIO
- LR LIPSTICK RED
- MB MIDNIGHT BLUE

- MG MEADOW GREEN
- MK MILK
- MS METALLIC SILVER
- NK NICKEL
- OC OCHRE
- PY PALE YELLOW
- RO RED ORANGE
- RR RUSTY RED
- SB SOFT BLUE
- SD SAND
- TC TERRACOTTA
- TP TAUPE

4. Options

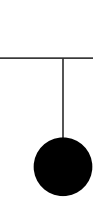

Polished Aluminum

- AL POLISHED ALUMINUM

Wood Finish +321

- 81 WHITE OAK
- 83 NATURAL MAPLE
- 85 WALNUT

Custom Color Match

- 09 CUSTOM COLOR

Per order per color - 20 chair minimum.
Contact customer service for details.

4. Options

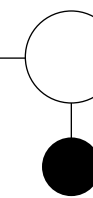

Ganging

- SG GANGING +53

Used to connect chairs to adjacent chairs or benches.

Power

- IN-SEAT POWER
C1X PORT W/10' CORD +452
- IN-SEAT POWER
C2X PORT W/20' CORD +485

See [page 7](#) for power port spec info.

Power Port Finish

Power ports can be finished in any standard powder coat available.

5. Upholstery Style

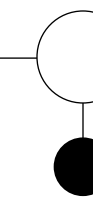

Upholstery Style

- U1 MONO-COLOR WATERLINE
- U2 DUAL-COLOR WATERLINE
- U3 SEAT & BACK, NO WATERLINE
- U4 SEAT & BACK, WITH WATERLINE
- U8 TRI-COLOR - SEAT, BACK & WATERLINE

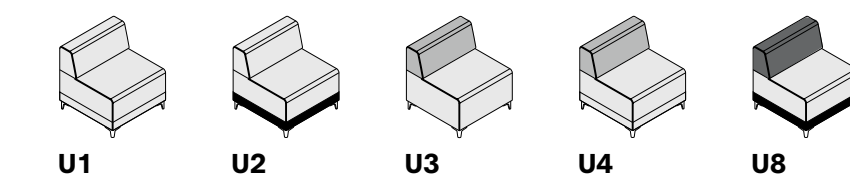

When pricing models with more than one fabric, the higher grade fabric will determine the overall grade of the specific product.

6. Upholstery

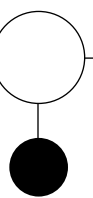

Upholstery

See [general information section](#) for details on textile program and COM/COL information.

Share will develop comfort wrinkles over time. The extent of these wrinkles is determined by the fabric specified.

Share

CHAIR: 90° INSIDE CURVED, TASK HEIGHT

Textile Upholstery Grades

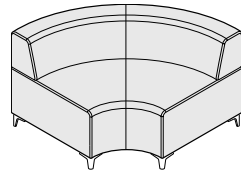
TITLE	SERIES	TYPE	SEAT	UPH	DIMENSIONS	YDG	COM	A	B	C	D	E	F	G	H	I	J	K	L	M	
Chair, 90° Inside Curved, Task Height 	Standard Upholstery	SH	14	78	56.25W x 28D x 29H	5.6	3,648	4,112	4,368	4,612	4,865	5,118	5,396	5,673	6,003	6,425	6,935	7,154	7,632	8,119	
	Mono-Color Waterline	SH	14	78	U1	56.25W x 28D x 29H	5.6	3,844	4,310	4,561	4,807	5,061	5,313	5,593	5,871	6,196	6,622	7,127	7,341	7,821	8,308
	Dual-Color Waterline	SH	14	78	U2	56.25W x 28D x 29H	4.8 above Waterline 0.9 below Waterline	3,844	4,317	4,577	4,826	5,081	5,341	5,624	5,906	6,241	6,671	7,185	7,407	7,894	8,389
	No Waterline Back & Seat	SH	14	78	U3	56.25W x 28D x 29H	1.8 Back 3.5 Seat	3,648	4,112	4,368	4,612	4,865	5,118	5,396	5,673	6,003	6,425	6,935	7,154	7,632	8,119
	Waterline Back & Seat	SH	14	78	U4	56.25W x 28D x 29H	1.3 Back 2.4 Seat/below Waterline	3,844	4,310	4,561	4,807	5,061	5,313	5,593	5,871	6,196	6,622	7,127	7,341	7,821	8,308
	Triple-Back & Seat & Waterline	SH	14	78	U8	56.25W x 28D x 29H	1 below Waterline 1.3 Back 2.4 Seat/above Waterline	3,844	4,317	4,577	4,826	5,081	5,341	5,624	5,906	6,241	6,671	7,185	7,407	7,894	8,389

To Order Select Below

1. Series/Type/Seat

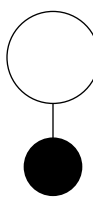

SH1478

Share
Chair, 90° Inside Curved
Task Height

2. Leg

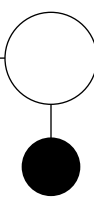

Leg

- L1 CORNER LEG, ADJ. PLASTIC GLIDES
- L2 ROUND LEG, ADJ. PLASTIC GLIDES
- L3 WOOD LEG

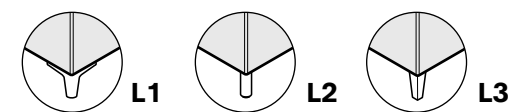

Mobility

The round leg glide has a larger diameter (1") than the corner leg for easier sliding on low pile carpet. Stylex is not responsible for damage to carpeting or floors.

3. Leg Finish

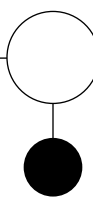

Standard Powder Coated Metal

- BL BLUE
- BM BLACK MATTE
- CP CHAMPAGNE
- DB DARK BRONZE
- DG DARK GRAY
- DP DUSTY PINK
- DS DARK SAGE
- LG LIGHT GRAY
- LL LILAC GRAY
- LP LIGHT PISTACHIO
- LR LIPSTICK RED
- MB MIDNIGHT BLUE

- MG MEADOW GREEN
- MK MILK
- MS METALLIC SILVER
- NK NICKEL
- OC OCHRE
- PY PALE YELLOW
- RO RED ORANGE
- RR RUSTY RED
- SB SOFT BLUE
- SD SAND
- TC TERRACOTTA
- TP TAUPE

4. Options

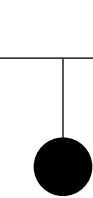

Polished Aluminum

- AL POLISHED ALUMINUM

Wood Finish +321

- 81 WHITE OAK
- 83 NATURAL MAPLE
- 85 WALNUT

Custom Color Match

- 09 CUSTOM COLOR

Per order per color - 20 chair minimum.
Contact customer service for details.

4. Options

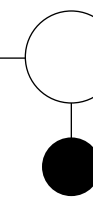

Ganging

- SG GANGING +53

Used to connect chairs to adjacent chairs or benches.

Power

- IN-SEAT POWER
C1X PORT W/10' CORD +452
- IN-SEAT POWER
C2X PORT W/20' CORD +485

See [page 7](#) for power port spec info.

Power Port Finish

Power ports can be finished in any standard powder coat available.

5. Upholstery Style

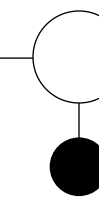

Upholstery Style

- U1 MONO-COLOR WATERLINE
- U2 DUAL-COLOR WATERLINE
- U3 SEAT & BACK, NO WATERLINE
- U4 SEAT & BACK, WITH WATERLINE
- U8 TRI-COLOR - SEAT, BACK & WATERLINE

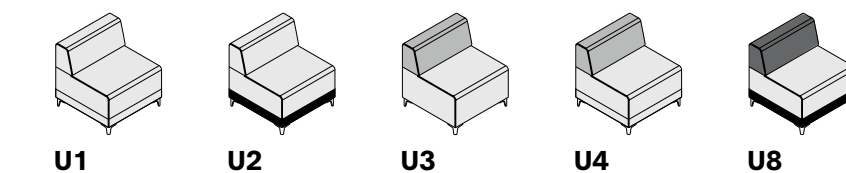

When pricing models with more than one fabric, the higher grade fabric will determine the overall grade of the specific product.

6. Upholstery

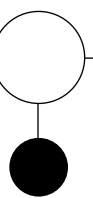

Upholstery

See [general information section](#) for details on textile program and COM/COL information.

Share will develop comfort wrinkles over time. The extent of these wrinkles is determined by the fabric specified.

Share

CHAIR: 90° OUTSIDE CURVED, LOUNGE HEIGHT

Textile Upholstery Grades

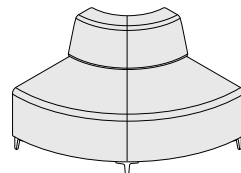
TITLE	SERIES	TYPE	SEAT	UPH	DIMENSIONS	YDG	COM	A	B	C	D	E	F	G	H	I	J	K	L	M
Chair, 90° Outside Curved, Lounge Height 	Standard Upholstery	SH	15	76	56.25W x 28D x 29H	4.5	3,209	3,584	3,788	3,986	4,190	4,393	4,616	4,839	5,103	5,443	5,849	6,256	6,658	7,066
	Mono-Color Waterline	SH	15	76	56.25W x 28D x 29H	4.5	3,473	3,847	4,052	4,248	4,453	4,656	4,878	5,103	5,364	5,705	6,112	6,520	6,920	7,329
	Dual-Color Waterline	SH	15	76	56.25W x 28D x 29H	3.8 above Waterline 1 below Waterline	3,473	3,872	4,088	4,299	4,516	4,733	4,972	5,210	5,488	5,854	6,290	6,722	7,150	7,584
	No Waterline Back & Seat	SH	15	76	56.25W x 28D x 29H	2.53 Back 3.3 Seat	3,209	3,584	3,788	3,986	4,190	4,393	4,616	4,839	5,103	5,443	5,849	6,256	6,658	7,066
	Waterline Back & Seat	SH	15	76	56.25W x 28D x 29H	2.3 Back 3 Seat/below Waterline	3,473	3,847	4,052	4,248	4,453	4,656	4,878	5,103	5,364	5,705	6,112	6,520	6,920	7,329
	Triple-Back & Seat & Waterline	SH	15	76	56.25W x 28D x 29H	0.8 below Waterline 2.3 Back 3 Seat/above Waterline	3,473	3,872	4,088	4,299	4,516	4,733	4,972	5,210	5,488	5,854	6,290	6,722	7,150	7,584

To Order Select Below

1. Series/Type/Seat

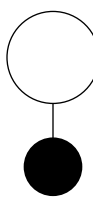

SH1576

Share
Chair, 90° Outside Curved,
Lounge Height

2. Leg

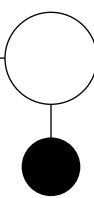

Leg

- L1 CORNER LEG, ADJ. PLASTIC GLIDES
- L2 ROUND LEG, ADJ. PLASTIC GLIDES
- L3 WOOD LEG

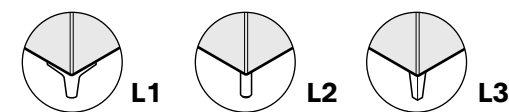

Mobility

The round leg glide has a larger diameter (1") than the corner leg for easier sliding on low pile carpet. Stylex is not responsible for damage to carpeting or floors.

3. Leg Finish

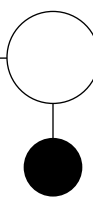

Standard Powder Coated Metal

- BL BLUE
- BM BLACK MATTE
- CP CHAMPAGNE
- DB DARK BRONZE
- DG DARK GRAY
- DP DUSTY PINK
- DS DARK SAGE
- LG LIGHT GRAY
- LL LILAC GRAY
- LP LIGHT PISTACHIO
- LR LIPSTICK RED
- MB MIDNIGHT BLUE

- MG MEADOW GREEN
- MK MILK
- MS METALLIC SILVER
- NK NICKEL
- OC OCHRE
- PY PALE YELLOW
- RO RED ORANGE
- RR RUSTY RED
- SB SOFT BLUE
- SD SAND
- TC TERRACOTTA
- TP TAUPE

4. Options

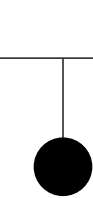

Polished Aluminum

- AL POLISHED ALUMINUM

Wood Finish +321

- 81 WHITE OAK
- 83 NATURAL MAPLE
- 85 WALNUT

Custom Color Match

- 09 CUSTOM COLOR

Per order per color - 20 chair minimum.
Contact customer service for details.

4. Options

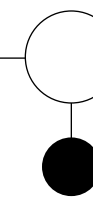

Ganging

- SG GANGING +53

Used to connect chairs to adjacent chairs or benches.

Power

- IN-SEAT POWER
C1X PORT W/10' CORD +452
- IN-SEAT POWER
C2X PORT W/20' CORD +485

See [page 7](#) for power port spec info.

Power Port Finish

Power ports can be finished in any standard powder coat available.

5. Upholstery Style

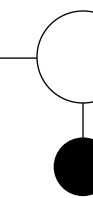

Upholstery Style

- U1 MONO-COLOR WATERLINE
- U2 DUAL-COLOR WATERLINE
- U3 SEAT & BACK, NO WATERLINE
- U4 SEAT & BACK, WITH WATERLINE
- U8 TRI-COLOR - SEAT, BACK & WATERLINE

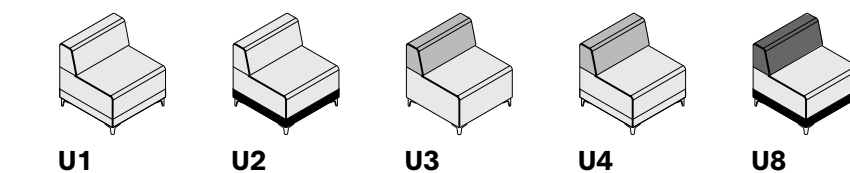

When pricing models with more than one fabric, the higher grade fabric will determine the overall grade of the specific product.

6. Upholstery

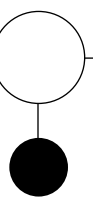

Upholstery

See [general information section](#) for details on textile program and COM/COL information.

Share will develop comfort wrinkles over time. The extent of these wrinkles is determined by the fabric specified.

Share

CHAIR: 90° OUTSIDE CURVED, TASK HEIGHT

Textile Upholstery Grades

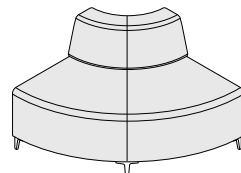
TITLE	SERIES	TYPE	SEAT	UPH	DIMENSIONS	YDG	COM	A	B	C	D	E	F	G	H	I	J	K	L	M
Chair, 90° Outside Curved, Task Height 	Standard Upholstery	SH	15	78	56.25W x 28D x 29H	4.5	3,209	3,584	3,788	3,986	4,190	4,393	4,616	4,839	5,103	5,443	5,849	6,256	6,658	7,066
	Mono-Color Waterline	SH	15	78	56.25W x 28D x 29H	4.5	3,473	3,847	4,052	4,248	4,453	4,656	4,878	5,103	5,364	5,705	6,112	6,520	6,920	7,329
	Dual-Color Waterline	SH	15	78	56.25W x 28D x 29H	3.7 above Waterline 1 below Waterline	3,473	3,864	4,077	4,283	4,494	4,707	4,940	5,174	5,450	5,804	6,229	6,655	7,074	7,497
	No Waterline Back & Seat	SH	15	78	56.25W x 28D x 29H	2.31 Back 3.3 Seat	3,209	3,584	3,788	3,986	4,190	4,393	4,616	4,839	5,103	5,443	5,849	6,256	6,658	7,066
	Waterline Back & Seat	SH	15	78	56.25W x 28D x 29H	2.1 Back 2.7 Seat/below Waterline	3,473	3,847	4,052	4,248	4,453	4,656	4,878	5,103	5,364	5,705	6,112	6,520	6,920	7,329
	Triple-Back & Seat & Waterline	SH	15	78	56.25W x 28D x 29H	0.9 below Waterline 2.1 Back 2.7 Seat/above Waterline	3,473	3,864	4,077	4,283	4,494	4,707	4,940	5,174	5,450	5,804	6,229	6,655	7,074	7,497

To Order Select Below

1. Series/Type/Seat

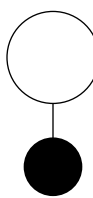

SH1578

Share
Chair, 90° Outside Curved,
Task Height

2. Leg

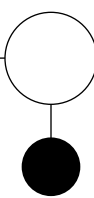

Leg

- L1 CORNER LEG, ADJ. PLASTIC GLIDES
- L2 ROUND LEG, ADJ. PLASTIC GLIDES
- L3 WOOD LEG

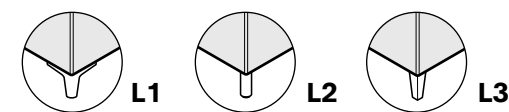

Mobility

The round leg glide has a larger diameter (1") than the corner leg for easier sliding on low pile carpet. Stylex is not responsible for damage to carpeting or floors.

3. Leg Finish

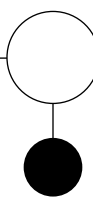

Standard Powder Coated Metal

- BL BLUE
- BM BLACK MATTE
- CP CHAMPAGNE
- DB DARK BRONZE
- DG DARK GRAY
- DP DUSTY PINK
- DS DARK SAGE
- LG LIGHT GRAY
- LL LILAC GRAY
- LP LIGHT PISTACHIO
- LR LIPSTICK RED
- MB MIDNIGHT BLUE

- MG MEADOW GREEN
- MK MILK
- MS METALLIC SILVER
- NK NICKEL
- OC OCHRE
- PY PALE YELLOW
- RO RED ORANGE
- RR RUSTY RED
- SB SOFT BLUE
- SD SAND
- TC TERRACOTTA
- TP TAUPE

4. Options

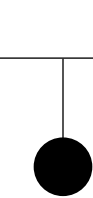

Polished Aluminum

- AL POLISHED ALUMINUM

Wood Finish +321

- 81 WHITE OAK
- 83 NATURAL MAPLE
- 85 WALNUT

Custom Color Match

- 09 CUSTOM COLOR

Per order per color - 20 chair minimum.
Contact customer service for details.

4. Options

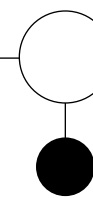

Ganging

- SG GANGING +53

Used to connect chairs to adjacent chairs or benches.

Power

- C1X IN-SEAT POWER PORT W/10' CORD +452
- C2X IN-SEAT POWER PORT W/20' CORD +485

See [page 7](#) for power port spec info.

Power Port Finish

Power ports can be finished in any standard powder coat available.

5. Upholstery Style

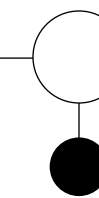

Upholstery Style

- U1 MONO-COLOR WATERLINE
- U2 DUAL-COLOR WATERLINE
- U3 SEAT & BACK, NO WATERLINE
- U4 SEAT & BACK, WITH WATERLINE
- U8 TRI-COLOR - SEAT, BACK & WATERLINE

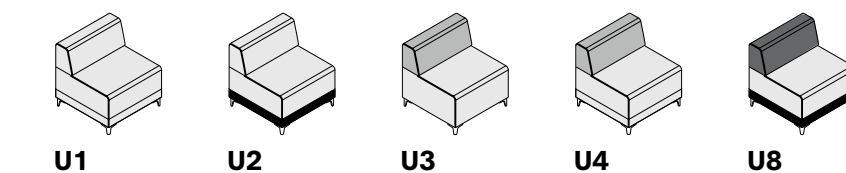

When pricing models with more than one fabric, the higher grade fabric will determine the overall grade of the specific product.

6. Upholstery

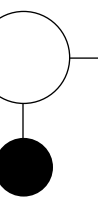

Upholstery

See [general information section](#) for details on textile program and COM/COL information.

Share will develop comfort wrinkles over time. The extent of these wrinkles is determined by the fabric specified.

Share

BENCH: SINGLE-SEATER

Textile Upholstery Grades

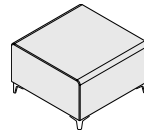
TITLE		SERIES	TYPE	SEAT	UPH	DIMENSIONS	YDG	COM	A	B	C	D	E	F	G	H	I	J	K	L	M
 Bench, Single-Seater, Lounge Height	Standard Upholstery	SH	01	16		28W x 28D x 16H	1.6	1,459	1,593	1,667	1,741	1,813	1,888	1,970	2,051	2,147	2,267	2,416	2,477	2,618	2,734
	Mono-Color Waterline	SH	01	16	U1	28W x 28D x 16H	1.7	1,574	1,708	1,783	1,854	1,929	2,004	2,084	2,165	2,261	2,385	2,530	2,656	2,805	2,929
	Dual-Color Waterline	SH	01	16	U2	28W x 28D x 16H	1.3 above Waterline 0.8 below Waterline	1,574	1,750	1,848	1,944	2,040	2,138	2,243	2,350	2,474	2,637	2,892	2,911	3,094	3,247
Bench, Single-Seater, Task Height	Standard Upholstery	SH	01	18		28W x 28D x 18H	1.6	1,459	1,603	1,681	1,757	1,837	1,915	2,003	2,088	2,187	2,318	2,474	2,477	2,618	2,734
	Mono-Color Waterline	SH	01	18	U1	28W x 28D x 18H	1.7	1,574	1,717	1,796	1,874	1,951	2,032	2,116	2,202	2,305	2,434	2,592	2,656	2,805	2,929
	Dual-Color Waterline	SH	01	18	U2	28W x 28D x 18H	1.4 above Waterline 0.8 below Waterline	1,574	1,757	1,861	1,960	2,060	2,163	2,274	2,387	2,519	2,687	2,948	2,974	3,167	3,327

To Order Select Below

1. Series/Type/Seat

- SH0116
Share Bench, Single-Seater, Lounge Height
- SH0118
Share Bench, Single-Seater, Task Height

2. Leg

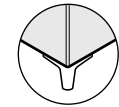
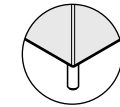
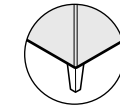
- Leg**
 - L1 CORNER LEG, ADJ. PLASTIC GLIDES
 - L2 ROUND LEG, ADJ. PLASTIC GLIDES
 - L3 WOOD LEG
- 
- 
- 
- Mobility**
The round leg glide has a larger diameter (1") than the corner leg for easier sliding on low pile carpet. Stylex is not responsible for damage to carpeting or floors.

3. Leg Finish

- Standard Powder Coated Metal**
- BL BLUE
- BM BLACK MATTE
- CP CHAMPAGNE
- DB DARK BRONZE
- DG DARK GRAY
- DP DUSTY PINK
- DS DARK SAGE
- LG LIGHT GRAY
- LL LILAC GRAY
- LP LIGHT PISTACHIO
- LR LIPSTICK RED
- MB MIDNIGHT BLUE
- MG MEADOW GREEN
- MK MILK
- MS METALLIC SILVER
- NK NICKEL
- OC OCHRE
- PY PALE YELLOW
- RO RED ORANGE
- RR RUSTY RED
- SB SOFT BLUE
- SD SAND
- TC TERRACOTTA
- TP TAUPE

4. Options

- Polished Aluminum**
 - AL POLISHED ALUMINUM
 - Wood Finish +224**
 - 81 WHITE OAK
 - 83 NATURAL MAPLE
 - 85 WALNUT
 - Custom Color Match**
 - 09 CUSTOM COLOR
- Per order per color - 20 chair minimum.
Contact customer service for details.

Ganging

- SG GANGING **+53**

Used to connect chairs to adjacent chairs or benches.

Power

- C1X IN-SEAT POWER PORT W/10' CORD **+452**
- C2X IN-SEAT POWER PORT W/20' CORD **+485**

See [page 7](#) for power port spec info.

Power Port Finish

Power ports can be finished in any standard powder coat available.

5. Upholstery Style

- Upholstery Style**
- U1 MONO-COLOR WATERLINE
- U2 DUAL-COLOR WATERLINE

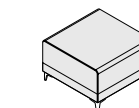

U1

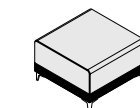

U2

When pricing models with more than one fabric, the higher grade fabric will determine the overall grade of the specific product.

6. Upholstery

- Upholstery**
- See general information section for details on textile program and COM/COL information.**

Share will develop comfort wrinkles over time. The extent of these wrinkles is determined by the fabric specified.

Share

BENCH: TWO-SEATER

Textile Upholstery Grades

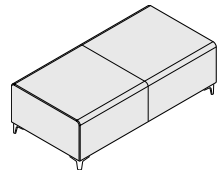
TITLE	SERIES	TYPE	SEAT	UPH	DIMENSIONS	YDG	COM	A	B	C	D	E	F	G	H	I	J	K	L	M
Bench, Two-Seater, Lounge Height 	Standard Upholstery	SH	01	26	56W x 28D x 16H	3.2	2,227	2,495	2,642	2,790	2,936	3,085	3,246	3,409	3,600	3,846	4,141	4,264	4,544	4,777
	Mono-Color Waterline	SH	01	26	56W x 28D x 16H	3.2	2,494	2,763	2,912	3,060	3,205	3,355	3,515	3,676	3,868	4,113	4,409	4,531	4,811	5,044
	Dual-Color Waterline	SH	01	26	56W x 28D x 16H	2.5 above Waterline 0.9 below Waterline	2,494	2,782	2,936	3,094	3,249	3,407	3,580	3,751	3,953	4,215	4,530	4,658	4,956	5,204
Bench, Two-Seater, Task Height	Standard Upholstery	SH	01	28	56W x 28D x 18H	3.4	2,227	2,512	2,669	2,827	2,980	3,139	3,312	3,482	3,687	3,948	4,260	4,391	4,688	4,937
	Mono-Color Waterline	SH	01	28	56W x 28D x 18H	3.4	2,494	2,782	2,936	3,094	3,249	3,407	3,580	3,751	3,953	4,215	4,530	4,658	4,956	5,204
	Dual-Color Waterline	SH	01	28	56W x 28D x 18H	2.7 above Waterline 0.9 below Waterline	2,494	2,799	2,964	3,129	3,294	3,460	3,643	3,827	4,039	4,318	4,648	4,786	5,100	5,363

To Order Select Below

1. Series/Type/Seat

SH0126

Share Bench, Two-Seater, Lounge Height

SH0128

Share Bench, Two-Seater, Task Height

2. Leg

Leg

L1 CORNER LEG, ADJ. PLASTIC GLIDES

L2 ROUND LEG, ADJ. PLASTIC GLIDES

L3 WOOD LEG

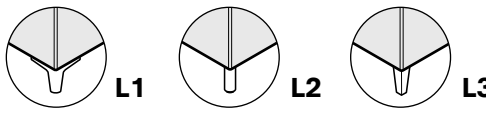

Mobility
The round leg glide has a larger diameter (1") than the corner leg for easier sliding on low pile carpet. Stylex is not responsible for damage to carpeting or floors.

3. Leg Finish

Standard Powder Coated Metal

BL BLUE

BM BLACK MATTE

CP CHAMPAGNE

DB DARK BRONZE

DG DARK GRAY

DP DUSTY PINK

DS DARK SAGE

LG LIGHT GRAY

LL LILAC GRAY

LP LIGHT PISTACHIO

LR LIPSTICK RED

MB MIDNIGHT BLUE

MG MEADOW GREEN

MK MILK

MS METALLIC SILVER

NK NICKEL

OC OCHRE

PY PALE YELLOW

RO RED ORANGE

RR RUSTY RED

SB SOFT BLUE

SD SAND

TC TERRACOTTA

TP TAUPE

4. Options

Ganging

SG GANGING **+53**

Used to connect chairs to adjacent chairs or benches.

Power

IN-SEAT POWER
C1X PORT W/10' CORD **+452**

IN-SEAT POWER
C2X PORT W/20' CORD **+485**

See [page 7](#) for power port spec info.

Power Port Finish
Power ports can be finished in any standard powder coat available.

5. Upholstery Style

Upholstery Style

U1 MONO-COLOR WATERLINE

U2 DUAL-COLOR WATERLINE

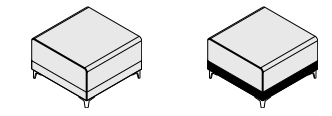

U1 **U2**

When pricing models with more than one fabric, the higher grade fabric will determine the overall grade of the specific product.

6. Upholstery

Upholstery

See general information section for details on textile program and COM/COL information.

Share will develop comfort wrinkles over time. The extent of these wrinkles is determined by the fabric specified.

Share

BENCH: THREE-SEATER

Textile Upholstery Grades

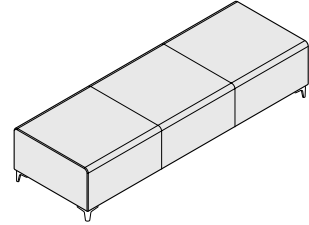
TITLE		SERIES	TYPE	SEAT	UPH	DIMENSIONS	YDG	COM	A	B	C	D	E	F	G	H	I	J	K	L	M
Bench, Three-Seater, Lounge Height 	Standard Upholstery	SH	01	36		84W x 28D x 16H	4.9	3,530	3,946	4,170	4,395	4,620	4,846	5,094	5,340	5,635	6,011	6,462	6,650	7,077	7,435
	Mono-Color Waterline	SH	01	36	U1	84W x 28D x 16H	4.9	3,916	4,328	4,552	4,778	5,003	5,229	5,478	5,726	6,020	6,395	6,847	7,036	7,463	7,821
	Dual-Color Waterline	SH	01	36	U2	84W x 28D x 16H	3.7 above Waterline 1.6 below Waterline	3,916	4,362	4,605	4,850	5,094	5,335	5,605	5,873	6,190	6,596	7,086	7,290	7,753	8,140
Bench, Three-Seater, Task Height	Standard Upholstery	SH	01	38		84W x 28D x 18H	5.2	3,530	3,970	4,207	4,447	4,687	4,925	5,190	5,453	5,765	6,162	6,642	6,840	7,295	7,674
	Mono-Color Waterline	SH	01	38	U1	84W x 28D x 18H	5.2	3,916	4,352	4,591	4,831	5,070	5,310	5,573	5,836	6,148	6,548	7,026	7,226	7,680	8,060
	Dual-Color Waterline	SH	01	38	U2	84W x 28D x 18H	4 above Waterline 1.6 below Waterline	3,916	4,388	4,645	4,904	5,159	5,416	5,700	5,985	6,321	6,750	7,265	7,481	7,971	8,379

To Order Select Below

1. Series/Type/Seat

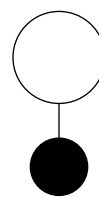

SH0136

**Share
Bench, Three-Seater,
Lounge Height**

SH0138

**Share
Bench, Three-Seater,
Task Height**

2. Leg

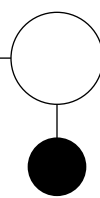

Leg

L1 CORNER LEG, ADJ. PLASTIC GLIDES

L2 ROUND LEG, ADJ. PLASTIC GLIDES

L3 WOOD LEG

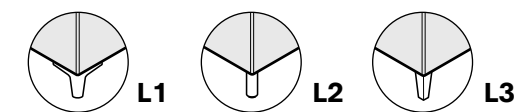

Mobility

The round leg glide has a larger diameter (1") than the corner leg for easier sliding on low pile carpet. Stylex is not responsible for damage to carpeting or floors.

3. Leg Finish

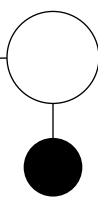

Standard Powder Coated Metal

BL BLUE

BM BLACK MATTE

CP CHAMPAGNE

DB DARK BRONZE

DG DARK GRAY

DP DUSTY PINK

DS DARK SAGE

LG LIGHT GRAY

LL LILAC GRAY

LP LIGHT PISTACHIO

LR LIPSTICK RED

MB MIDNIGHT BLUE

MG MEADOW GREEN

MK MILK

MS METALLIC SILVER

NK NICKEL

OC OCHRE

PY PALE YELLOW

RO RED ORANGE

RR RUSTY RED

SB SOFT BLUE

SD SAND

TC TERRACOTTA

TP TAUPE

4. Options

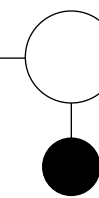

Ganging

SG GANGING **+53**

Used to connect chairs to adjacent chairs or benches.

Power

IN-SEAT POWER
C1X PORT W/10' CORD **+452**

IN-SEAT POWER
C2X PORT W/20' CORD **+485**

See [page 7](#) for power port spec info.

Power Port Finish

Power ports can be finished in any standard powder coat available.

5. Upholstery Style

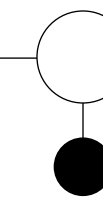

Upholstery Style

U1 MONO-COLOR WATERLINE

U2 DUAL-COLOR WATERLINE

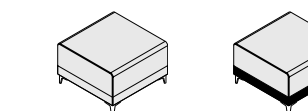

U1

U2

When pricing models with more than one fabric, the higher grade fabric will determine the overall grade of the specific product.

6. Upholstery

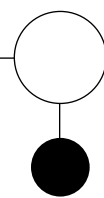

Upholstery

See general information section for details on textile program and COM/COL information.

Share will develop comfort wrinkles over time. The extent of these wrinkles is determined by the fabric specified.

Share

BENCH: 120° CORNER

Textile Upholstery Grades

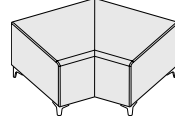
TITLE		SERIES	TYPE	SEAT	UPH	DIMENSIONS	YDG	COM	A	B	C	D	E	F	G	H	I	J	K	L	M
 Bench, 120° Corner, Lounge Height	Standard Upholstery	SH	02	46		42.5W x 28D x 16H	2.4	2,979	3,178	3,283	3,390	3,499	3,606	3,724	3,843	3,981	4,159	4,374	4,506	4,716	4,891
	Mono-Color Waterline	SH	02	46	U1	42.5W x 28D x 16H	2.1	3,241	3,411	3,507	3,600	3,694	3,788	3,891	3,994	4,118	4,273	4,462	4,578	4,761	4,914
	Dual-Color Waterline	SH	02	46	U2	42.5W x 28D x 16H	1.7 above Waterline 0.8 below Waterline	3,241	3,446	3,556	3,669	3,779	3,892	4,015	4,139	4,285	4,470	4,694	4,832	5,050	5,233
Bench, 120° Corner, Task Height	Standard Upholstery	SH	02	48		42.5W x 28D x 18H	2.5	2,979	3,184	3,297	3,408	3,519	3,631	3,755	3,879	4,023	4,208	4,432	4,570	4,788	4,971
	Mono-Color Waterline	SH	02	48	U1	42.5W x 28D x 18H	2.2	3,241	3,421	3,518	3,617	3,716	3,815	3,923	4,030	4,158	4,323	4,518	4,642	4,834	4,994
	Dual-Color Waterline	SH	02	48	U2	42.5W x 28D x 18H	1.9 above Waterline 0.8 below Waterline	3,241	3,460	3,583	3,704	3,822	3,946	4,078	4,210	4,366	4,568	4,809	4,960	5,196	5,392

To Order Select Below

1. Series/Type/Seat

SH0246

Share
Bench, 120° Corner, Lounge Height

SH0248

Share
Bench, 120° Corner, Task Height

2. Leg

Leg

L1 CORNER LEG, ADJ. PLASTIC GLIDES
L2 ROUND LEG, ADJ. PLASTIC GLIDES
L3 WOOD LEG

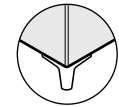
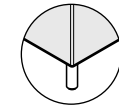
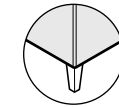
Mobility
The round leg glide has a larger diameter (1") than the corner leg for easier sliding on low pile carpet. Stylex is not responsible for damage to carpeting or floors.

3. Leg Finish

Standard Powder Coated Metal

BL BLUE
BM BLACK MATTE
CP CHAMPAGNE
DB DARK BRONZE
DG DARK GRAY
DP DUSTY PINK
DS DARK SAGE
LG LIGHT GRAY
LL LILAC GRAY
LP LIGHT PISTACHIO
LR LIPSTICK RED
MB MIDNIGHT BLUE

MG MEADOW GREEN
MK MILK
MS METALLIC SILVER
NK NICKEL
OC OCHRE
PY PALE YELLOW
RO RED ORANGE
RR RUSTY RED
SB SOFT BLUE
SD SAND
TC TERRACOTTA
TP TAUPE

Polished Aluminum

AL POLISHED ALUMINUM

Wood Finish +224

81 WHITE OAK
83 NATURAL MAPLE
85 WALNUT

Custom Color Match

09 CUSTOM COLOR

Per order per color - 20 chair minimum.
Contact customer service for details.

4. Options

Ganging

SG GANGING **+53**

Used to connect chairs to adjacent chairs or benches.

Power

IN-SEAT POWER
C1X PORT W/10' CORD **+452**

IN-SEAT POWER
C2X PORT W/20' CORD **+485**

See [page 7](#) for power port spec info.

Power Port Finish

Power ports can be finished in any standard powder coat available.

5. Upholstery Style

Upholstery Style

U1 MONO-COLOR WATERLINE
U2 DUAL-COLOR WATERLINE

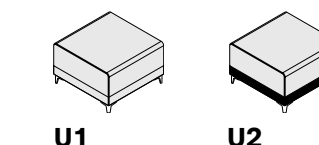

U1

U2

When pricing models with more than one fabric, the higher grade fabric will determine the overall grade of the specific product.

6. Upholstery

Upholstery

See general information section for details on textile program and COM/COL information.

Share will develop comfort wrinkles over time. The extent of these wrinkles is determined by the fabric specified.

Share

BENCH: 30° INSIDE CORNER

Textile Upholstery Grades

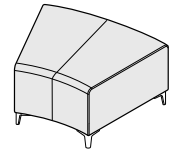
TITLE		SERIES	TYPE	SEAT	UPH	DIMENSIONS	YDG	COM	A	B	C	D	E	F	G	H	I	J	K	L	M
 Bench, 30° Inside Curved, Lounge Height	Standard Upholstery	SH	04	56		35W x 28D x 16H	2.4	2,462	2,466	2,580	2,694	2,809	2,926	3,050	3,178	3,326	3,519	3,751	3,830	4,049	4,272
	Mono-Color Waterline	SH	04	56	U1	35W x 28D x 16H	2.4	2,462	2,673	2,789	2,900	3,018	3,132	3,259	3,386	3,536	3,730	3,959	4,032	4,249	4,472
	Dual-Color Waterline	SH	04	56	U2	35W x 28D x 16H	1.9 above Waterline 0.8 below Waterline	2,462	2,701	2,833	2,956	3,085	3,217	3,360	3,503	3,668	3,888	4,145	4,238	4,484	4,734
Bench, 30° Inside Curved, Task Height	Standard Upholstery	SH	04	58		35W x 28D x 18H	2.4	2,462	2,466	2,580	2,694	2,809	2,926	3,050	3,178	3,326	3,519	3,751	3,830	4,049	4,272
	Mono-Color Waterline	SH	04	58	U1	35W x 28D x 18H	2.4	2,462	2,673	2,789	2,900	3,018	3,132	3,259	3,386	3,536	3,730	3,959	4,032	4,249	4,472
	Dual-Color Waterline	SH	04	58	U2	35W x 28D x 18H	1.6 above Waterline 0.8 below Waterline	2,462	2,673	2,789	2,900	3,018	3,132	3,259	3,386	3,536	3,730	3,959	4,032	4,249	4,472

To Order Select Below

1. Series/Type/Seat

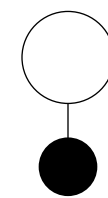

SH0456

Share
Bench, 30° Inside Curved, Lounge Height

SH0458

Share
Bench, 30° Inside Curved, Task Height

2. Leg

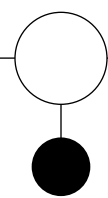

Leg

L1 CORNER LEG, ADJ. PLASTIC GLIDES

L2 ROUND LEG, ADJ. PLASTIC GLIDES

L3 WOOD LEG

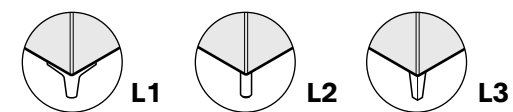

Mobility

The round leg glide has a larger diameter (1") than the corner leg for easier sliding on low pile carpet. Stylex is not responsible for damage to carpeting or floors.

3. Leg Finish

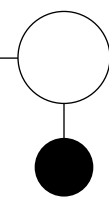

Standard Powder Coated Metal

BL BLUE

BM BLACK MATTE

CP CHAMPAGNE

DB DARK BRONZE

DG DARK GRAY

DP DUSTY PINK

DS DARK SAGE

LG LIGHT GRAY

LL LILAC GRAY

LP LIGHT PISTACHIO

LR LIPSTICK RED

MB MIDNIGHT BLUE

MG MEADOW GREEN

MK MILK

MS METALLIC SILVER

NK NICKEL

OC OCHRE

PY PALE YELLOW

RO RED ORANGE

RR RUSTY RED

SB SOFT BLUE

SD SAND

TC TERRACOTTA

TP TAUPE

4. Options

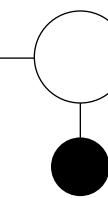

Ganging

SG GANGING **+53**

Used to connect chairs to adjacent chairs or benches.

Power

IN-SEAT POWER
C1X PORT W/10' CORD **+452**

IN-SEAT POWER
C2X PORT W/20' CORD **+485**

See [page 7](#) for power port spec info.

Power Port Finish

Power ports can be finished in any standard powder coat available.

5. Upholstery Style

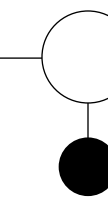

Upholstery Style

U1 MONO-COLOR WATERLINE

U2 DUAL-COLOR WATERLINE

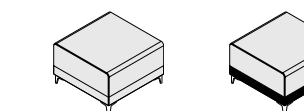

U1

U2

When pricing models with more than one fabric, the higher grade fabric will determine the overall grade of the specific product.

6. Upholstery

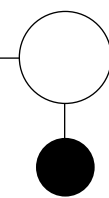

Upholstery

See general information section for details on textile program and COM/COL information.

Share will develop comfort wrinkles over time. The extent of these wrinkles is determined by the fabric specified.

Share

BENCH: 60° INSIDE CORNER

Textile Upholstery Grades

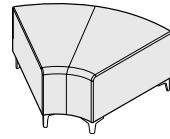
TITLE	SERIES	TYPE	SEAT	UPH	DIMENSIONS	YDG	COM	A	B	C	D	E	F	G	H	I	J	K	L	M	
 Bench, 60° Inside Curved, Lounge Height	Standard Upholstery	SH	04	66	39.75W x 28D x 16H	2.5	2,695	2,714	2,842	2,963	3,086	3,214	3,351	3,488	3,649	3,858	4,109	4,191	4,429	4,670	
	Mono-Color Waterline	SH	04	66	U1	39.75W x 28D x 16H	2.5	2,695	2,926	3,049	3,171	3,295	3,421	3,558	3,696	3,857	4,068	4,319	4,393	4,631	4,871
	Dual-Color Waterline	SH	04	66	U2	39.75W x 28D x 16H	2 above Waterline 0.8 below Waterline	2,695	2,944	3,076	3,207	3,342	3,478	3,625	3,773	3,948	4,172	4,445	4,532	4,787	5,046
Bench, 60° Inside Curved, Task Height	Standard Upholstery	SH	04	68	39.75W x 28D x 18H	2.6	2,695	2,787	2,907	3,022	3,143	3,262	3,397	3,528	3,685	3,884	4,127	4,200	4,427	4,658	
	Mono-Color Waterline	SH	04	68	U1	39.75W x 28D x 18H	2.6	2,695	2,993	3,114	3,230	3,353	3,472	3,603	3,736	3,890	4,092	4,332	4,398	4,628	4,860
	Dual-Color Waterline	SH	04	68	U2	39.75W x 28D x 18H	2.5 above Waterline 0.8 below Waterline	2,772	3,065	3,223	3,377	3,538	3,695	3,870	4,042	4,249	4,515	4,835	4,952	5,256	5,560

To Order Select Below

1. Series/Type/Seat

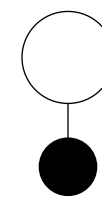

SH0466

Share
Bench, 60° Inside Curved, Lounge Height

SH0468

Share
Bench, 60° Inside Curved, Task Height

2. Leg

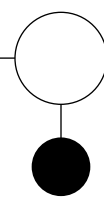

Leg

L1 CORNER LEG, ADJ. PLASTIC GLIDES

L2 ROUND LEG, ADJ. PLASTIC GLIDES

L3 WOOD LEG

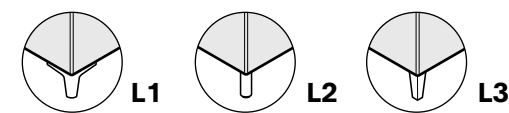

Mobility

The round leg glide has a larger diameter (1") than the corner leg for easier sliding on low pile carpet. Stylex is not responsible for damage to carpeting or floors.

3. Leg Finish

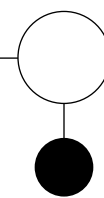

Standard Powder Coated Metal

BL BLUE

BM BLACK MATTE

CP CHAMPAGNE

DB DARK BRONZE

DG DARK GRAY

DP DUSTY PINK

DS DARK SAGE

LG LIGHT GRAY

LL LILAC GRAY

LP LIGHT PISTACHIO

LR LIPSTICK RED

MB MIDNIGHT BLUE

MG MEADOW GREEN

MK MILK

MS METALLIC SILVER

NK NICKEL

OC OCHRE

PY PALE YELLOW

RO RED ORANGE

RR RUSTY RED

SB SOFT BLUE

SD SAND

TC TERRACOTTA

TP TAUPE

4. Options

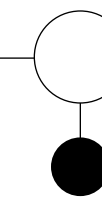

Ganging

SG GANGING **+53**

Used to connect chairs to adjacent chairs or benches.

Power

IN-SEAT POWER
C1X PORT W/10' CORD **+452**

IN-SEAT POWER
C2X PORT W/20' CORD **+485**

See [page 7](#) for power port spec info.

Power Port Finish

Power ports can be finished in any standard powder coat available.

5. Upholstery Style

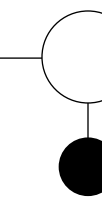

Upholstery Style

U1 MONO-COLOR WATERLINE

U2 DUAL-COLOR WATERLINE

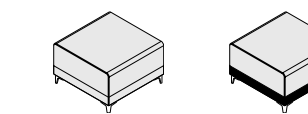

U1

U2

When pricing models with more than one fabric, the higher grade fabric will determine the overall grade of the specific product.

6. Upholstery

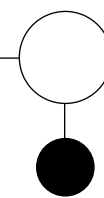

Upholstery

See general information section for details on textile program and COM/COL information.

Share will develop comfort wrinkles over time. The extent of these wrinkles is determined by the fabric specified.

Share

BENCH: 90° INSIDE CORNER

Textile Upholstery Grades

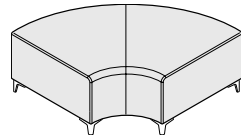
TITLE		SERIES	TYPE	SEAT	UPH	DIMENSIONS	YDG	COM	A	B	C	D	E	F	G	H	I	J	K	L	M
Bench, 90° Inside Curved, Lounge Height 	Standard Upholstery	SH	04	76		56.25W x 28D x 16H	3.5	3,387	3,418	3,586	3,749	3,919	4,086	4,271	4,455	4,673	4,958	5,294	5,414	5,735	6,058
	Mono-Color Waterline	SH	04	76	U1	56.25W x 28D x 16H	3.5	3,387	3,698	3,865	4,031	4,198	4,367	4,550	4,735	4,952	5,237	5,573	5,683	6,004	6,327
	Dual-Color Waterline	SH	04	76	U2	56.25W x 28D x 16H	3 above Waterline 0.8 below Waterline	3,387	3,726	3,906	4,082	4,265	4,449	4,651	4,851	5,088	5,396	5,762	5,891	6,238	6,592
Bench, 90° Inside Curved, Task Height	Standard Upholstery	SH	04	78		56.25W x 28D x 18H	3.5	3,387	3,498	3,664	3,827	3,997	4,165	4,349	4,535	4,752	5,035	5,371	5,489	5,808	6,133
	Mono-Color Waterline	SH	04	78	U1	56.25W x 28D x 18H	3.5	3,387	3,776	3,944	4,107	4,276	4,445	4,629	4,813	5,030	5,313	5,652	5,757	6,077	6,401
	Dual-Color Waterline	SH	04	78	U2	56.25W x 28D x 18H	2.7 above Waterline 0.8 below Waterline	3,466	3,776	3,944	4,107	4,276	4,445	4,629	4,813	5,030	5,313	5,652	5,757	6,077	6,401

To Order Select Below

1. Series/Type/Seat

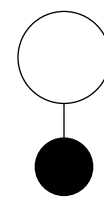

SH0476

Share
Bench, 90° Inside Curved, Lounge Height

SH0478

Share
Bench, 90° Inside Curved, Task Height

2. Leg

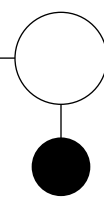

Leg

L1 CORNER LEG, ADJ. PLASTIC GLIDES

L2 ROUND LEG, ADJ. PLASTIC GLIDES

L3 WOOD LEG

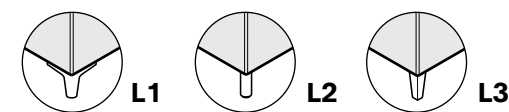

Mobility

The round leg glide has a larger diameter (1") than the corner leg for easier sliding on low pile carpet. Stylex is not responsible for damage to carpeting or floors.

3. Leg Finish

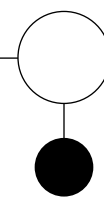

Standard Powder Coated Metal

BL BLUE

BM BLACK MATTE

CP CHAMPAGNE

DB DARK BRONZE

DG DARK GRAY

DP DUSTY PINK

DS DARK SAGE

LG LIGHT GRAY

LL LILAC GRAY

LP LIGHT PISTACHIO

LR LIPSTICK RED

MB MIDNIGHT BLUE

MG MEADOW GREEN

MK MILK

MS METALLIC SILVER

NK NICKEL

OC OCHRE

PY PALE YELLOW

RO RED ORANGE

RR RUSTY RED

SB SOFT BLUE

SD SAND

TC TERRACOTTA

TP TAUPE

4. Options

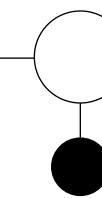

Ganging

SG GANGING **+53**

Used to connect chairs to adjacent chairs or benches.

Power

IN-SEAT POWER
C1X PORT W/10' CORD **+452**

IN-SEAT POWER
C2X PORT W/20' CORD **+485**

See [page 7](#) for power port spec info.

Power Port Finish

Power ports can be finished in any standard powder coat available.

5. Upholstery Style

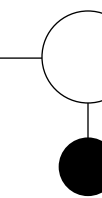

Upholstery Style

U1 MONO-COLOR WATERLINE

U2 DUAL-COLOR WATERLINE

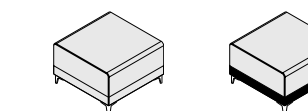

U1

U2

When pricing models with more than one fabric, the higher grade fabric will determine the overall grade of the specific product.

6. Upholstery

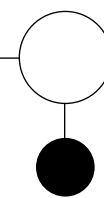

Upholstery

See general information section for details on textile program and COM/COL information.

Share will develop comfort wrinkles over time. The extent of these wrinkles is determined by the fabric specified.

Share

BENCH: OUTSIDE CORNER

Textile Upholstery Grades

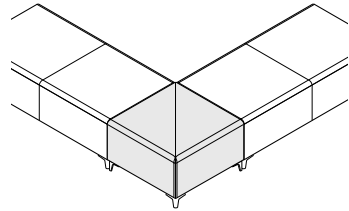
TITLE	SERIES	TYPE	SEAT	UPH	DIMENSIONS	YDG	COM	A	B	C	D	E	F	G	H	I	J	K	L	M	
Bench, Outside Corner, Lounge Height 	Standard Upholstery	SH	06	16	28W x 28D x 16H	2	1,459	1,629	1,720	1,811	1,903	1,996	2,096	2,198	2,317	2,470	2,657	2,731	2,907	3,036	
	Mono-Color Waterline	SH	06	16	U1	28W x 28D x 16H	2	1,574	1,744	1,835	1,925	2,017	2,111	2,211	2,313	2,432	2,584	2,771	2,841	3,018	3,146
	Dual-Color Waterline	SH	06	16	U2	28W x 28D x 16H	1.6 above Waterline 0.9 below Waterline	1,574	1,786	1,900	2,011	2,128	2,243	2,372	2,496	2,647	2,839	3,070	3,174	3,394	3,554
Bench, Outside Corner, Task Height	Standard Upholstery	SH	06	18	28W x 28D x 18H	2.2	1,459	1,644	1,748	1,846	1,947	2,050	2,159	2,272	2,403	2,574	2,775	2,865	3,057	3,198	
	Mono-Color Waterline	SH	06	18	U1	28W x 28D x 18H	2.2	1,574	1,759	1,863	1,960	2,060	2,163	2,274	2,387	2,519	2,687	2,891	2,975	3,167	3,309
	Dual-Color Waterline	SH	06	18	U2	28W x 28D x 18H	1.7 above Waterline 0.9 below Waterline	1,574	1,795	1,915	2,032	2,150	2,271	2,401	2,533	2,689	2,891	3,130	3,241	3,468	3,637

To Order Select Below

1. Series/Type/Seat

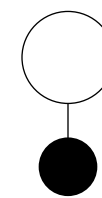

SH0616

Share
Bench, Outside Corner,
Lounge Height

SH0618

Share
Bench, Outside Corner,
Task Height

2. Leg

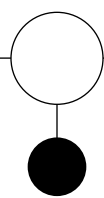

Leg

L1 CORNER LEG, ADJ. PLASTIC GLIDES

L2 ROUND LEG, ADJ. PLASTIC GLIDES

L3 WOOD LEG

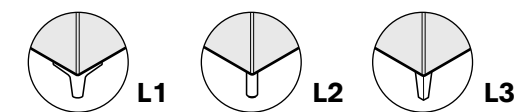

Mobility

The round leg glide has a larger diameter (1") than the corner leg for easier sliding on low pile carpet. Stylex is not responsible for damage to carpeting or floors.

3. Leg Finish

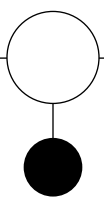

Standard Powder Coated Metal

BL BLUE

BM BLACK MATTE

CP CHAMPAGNE

DB DARK BRONZE

DG DARK GRAY

DP DUSTY PINK

DS DARK SAGE

LG LIGHT GRAY

LL LILAC GRAY

LP LIGHT PISTACHIO

LR LIPSTICK RED

MB MIDNIGHT BLUE

MG MEADOW GREEN

MK MILK

MS METALLIC SILVER

NK NICKEL

OC OCHRE

PY PALE YELLOW

RO RED ORANGE

RR RUSTY RED

SB SOFT BLUE

SD SAND

TC TERRACOTTA

TP TAUPE

4. Options

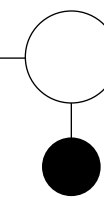

Ganging

SG GANGING **+53**

Used to connect chairs to adjacent chairs or benches.

Power

IN-SEAT POWER
C1X PORT W/10' CORD **+452**

IN-SEAT POWER
C2X PORT W/20' CORD **+485**

See [page 7](#) for power port spec info.

Power Port Finish

Power ports can be finished in any standard powder coat available.

5. Upholstery Style

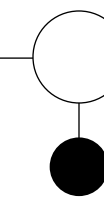

Upholstery Style

U1 MONO-COLOR WATERLINE

U2 DUAL-COLOR WATERLINE

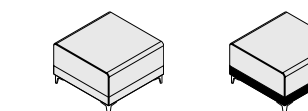

U1

U2

When pricing models with more than one fabric, the higher grade fabric will determine the overall grade of the specific product.

6. Upholstery

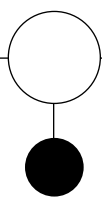

Upholstery

See general information section for details on textile program and COM/COL information.

Share will develop comfort wrinkles over time. The extent of these wrinkles is determined by the fabric specified.

Share

END CAP: SINGLE NARROW

Textile Upholstery Grades

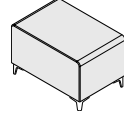
TITLE		SERIES	TYPE	SEAT	UPH	DIMENSIONS	YDG	COM	A	B	C	D	E	F	G	H	I	J	K	L	M
 End Cap, Single Narrow, Lounge Height	Standard Upholstery	SH	03	06		19W x 28D x 16H	1.6	1,306	1,439	1,514	1,588	1,661	1,737	1,814	1,897	1,992	2,114	2,262	2,324	2,465	2,581
	Mono-Color Waterline	SH	03	06	U1	19W x 28D x 16H	1.3	1,494	1,607	1,666	1,724	1,785	1,846	1,913	1,977	2,054	2,154	2,273	2,322	2,436	2,530
	Dual-Color Waterline	SH	03	06	U2	19W x 28D x 16H	1.3 above Waterline 0.4 below Waterline	1,494	1,640	1,717	1,797	1,874	1,952	2,038	2,124	2,228	2,357	2,513	2,577	2,726	2,850
End Cap, Single Narrow, Task Height	Standard Upholstery	SH	03	08		19W x 28D x 18H	1.7	1,306	1,448	1,527	1,606	1,682	1,761	1,848	1,931	2,036	2,165	2,320	2,389	2,538	2,661
	Mono-Color Waterline	SH	03	08	U1	19W x 28D x 18H	1.4	1,494	1,613	1,679	1,744	1,809	1,873	1,943	2,013	2,097	2,205	2,335	2,386	2,508	2,610
	Dual-Color Waterline	SH	03	08	U2	19W x 28D x 18H	1.4 above Waterline 0.4 below Waterline	1,494	1,649	1,731	1,813	1,897	1,979	2,071	2,161	2,270	2,408	2,574	2,641	2,798	2,929

To Order Select Below

1. Series/Type/Seat

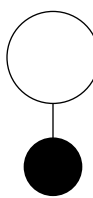

SH0306

Share
End Cap, Single Narrow,
Lounge Height

SH0308

Share
End Cap, Single Narrow,
Task Height

2. Leg

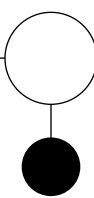

Leg

L1 CORNER LEG, ADJ. PLASTIC GLIDES

L2 ROUND LEG, ADJ. PLASTIC GLIDES

L3 WOOD LEG

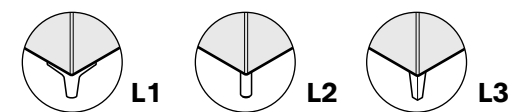

Mobility

The round leg glide has a larger diameter (1") than the corner leg for easier sliding on low pile carpet. Stylex is not responsible for damage to carpeting or floors.

3. Leg Finish

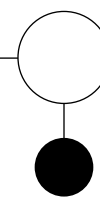

Standard Powder Coated Metal

BL BLUE

BM BLACK MATTE

CP CHAMPAGNE

DB DARK BRONZE

DG DARK GRAY

DP DUSTY PINK

DS DARK SAGE

LG LIGHT GRAY

LL LILAC GRAY

LP LIGHT PISTACHIO

LR LIPSTICK RED

MB MIDNIGHT BLUE

MG MEADOW GREEN

MK MILK

MS METALLIC SILVER

NK NICKEL

OC OCHRE

PY PALE YELLOW

RO RED ORANGE

RR RUSTY RED

SB SOFT BLUE

SD SAND

TC TERRACOTTA

TP TAUPE

4. Options

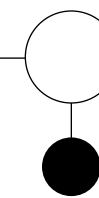

Ganging

SG GANGING **+53**

Used to connect chairs to adjacent chairs or benches.

Power

IN-SEAT POWER
C1X PORT W/10' CORD **+452**

IN-SEAT POWER
C2X PORT W/20' CORD **+485**

See [page 7](#) for power port spec info.

Power Port Finish

Power ports can be finished in any standard powder coat available.

5. Upholstery Style

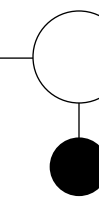

Upholstery Style

U1 MONO-COLOR WATERLINE

U2 DUAL-COLOR WATERLINE

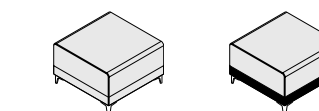

U1

U2

When pricing models with more than one fabric, the higher grade fabric will determine the overall grade of the specific product.

6. Upholstery

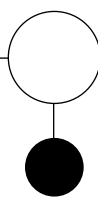

Upholstery

See general information section for details on textile program and COM/COL information.

Share will develop comfort wrinkles over time. The extent of these wrinkles is determined by the fabric specified.

Share

END CAP: DOUBLE NARROW

Textile Upholstery Grades

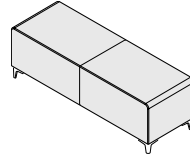
TITLE	SERIES	TYPE	SEAT	UPH	DIMENSIONS	YDG	COM	A	B	C	D	E	F	G	H	I	J	K	L	M	
 End Cap, Double Narrow, Lounge Height	Standard Upholstery	SH	03	16	19W x 56D x 16H	2	1,920	2,088	2,181	2,271	2,361	2,455	2,556	2,658	2,777	2,931	3,116	3,193	3,368	3,514	
	Mono-Color Waterline	SH	03	16	U1	19W x 56D x 16H	2	2,149	2,317	2,409	2,501	2,595	2,686	2,787	2,888	3,009	3,162	3,346	3,422	3,596	3,743
	Dual-Color Waterline	SH	03	16	U2	19W x 56D x 16H	1.8 above Waterline 0.8 below Waterline	2,149	2,368	2,489	2,607	2,726	2,845	2,978	3,109	3,268	3,466	3,704	3,804	4,031	4,221
End Cap, Double Narrow, Task Height	Standard Upholstery	SH	03	18	19W x 56D x 18H	2.1	1,920	2,095	2,192	2,288	2,386	2,484	2,585	2,695	2,820	2,980	3,174	3,257	3,440	3,593	
	Mono-Color Waterline	SH	03	18	U1	19W x 56D x 18H	2.2	2,149	2,335	2,436	2,537	2,638	2,741	2,852	2,963	3,094	3,264	3,466	3,550	3,742	3,902
	Dual-Color Waterline	SH	03	18	U2	19W x 56D x 18H	1.9 above Waterline 0.8 below Waterline	2,149	2,376	2,499	2,625	2,751	2,874	3,010	3,146	3,311	3,515	3,763	3,868	4,104	4,300

To Order Select Below

1. Series/Type/Seat

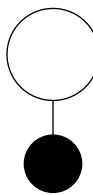

SH0316
Share
End Cap, Double Narrow, Lounge Height

SH0318
Share
End Cap, Double Narrow Task Height

2. Leg

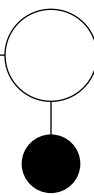

Leg

- L1 CORNER LEG, ADJ. PLASTIC GLIDES
- L2 ROUND LEG, ADJ. PLASTIC GLIDES
- L3 WOOD LEG

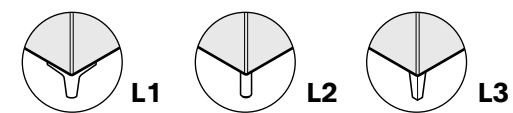

Mobility

The round leg glide has a larger diameter (1") than the corner leg for easier sliding on low pile carpet. Stylex is not responsible for damage to carpeting or floors.

3. Leg Finish

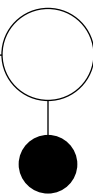

Standard Powder Coated Metal

- BL BLUE
- BM BLACK MATTE
- CP CHAMPAGNE
- DB DARK BRONZE
- DG DARK GRAY
- DP DUSTY PINK
- DS DARK SAGE
- LG LIGHT GRAY
- LL LILAC GRAY
- LP LIGHT PISTACHIO
- LR LIPSTICK RED
- MB MIDNIGHT BLUE

- MG MEADOW GREEN
- MK MILK
- MS METALLIC SILVER
- NK NICKEL
- OC OCHRE
- PY PALE YELLOW
- RO RED ORANGE
- RR RUSTY RED
- SB SOFT BLUE
- SD SAND
- TC TERRACOTTA
- TP TAUPE

Polished Aluminum

- AL POLISHED ALUMINUM

Wood Finish +224

- 81 WHITE OAK
- 83 NATURAL MAPLE
- 85 WALNUT

Custom Color Match

- 09 CUSTOM COLOR

Per order per color - 20 chair minimum.
Contact customer service for details.

4. Options

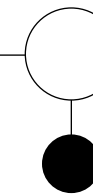

Ganging

- SG GANGING **+53**

Used to connect chairs to adjacent chairs or benches.

Power

- C1X IN-SEAT POWER PORT W/10' CORD **+452**
- C2X IN-SEAT POWER PORT W/20' CORD **+485**

See [page 7](#) for power port spec info.

Power Port Finish

Power ports can be finished in any standard powder coat available.

5. Upholstery Style

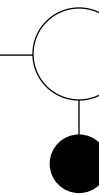

Upholstery Style

- U1 MONO-COLOR WATERLINE
- U2 DUAL-COLOR WATERLINE

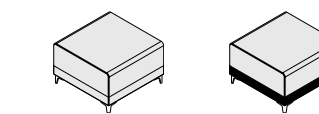

U1 U2

When pricing models with more than one fabric, the higher grade fabric will determine the overall grade of the specific product.

6. Upholstery

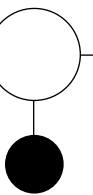

Upholstery

See general information section for details on textile program and COM/COL information.

Share will develop comfort wrinkles over time. The extent of these wrinkles is determined by the fabric specified.

Share

END CAP: DOUBLE NARROW +

Textile Upholstery Grades

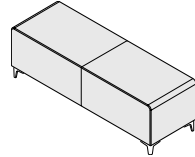
TITLE		SERIES	TYPE	SEAT	UPH	DIMENSIONS	YDG	COM	A	B	C	D	E	F	G	H	I	J	K	L	M
 End Cap, Double Narrow +, Lounge Height	Standard Upholstery	SH	03	26		19W x 57D x 16H	2.1	1,996	2,172	2,270	2,367	2,463	2,560	2,666	2,771	2,898	3,060	3,252	3,333	3,516	3,669
	Mono-Color Waterline	SH	03	26	U1	19W x 57D x 16H	2.1	2,227	2,401	2,497	2,596	2,693	2,789	2,895	3,005	3,127	3,287	3,482	3,564	3,747	3,900
	Dual-Color Waterline	SH	03	26	U2	19W x 57D x 16H	1.9 above Waterline 0.8 below Waterline	2,227	2,452	2,578	2,702	2,829	2,948	3,089	3,227	3,385	3,591	3,842	3,946	4,182	4,378
End Cap, Double Narrow +, Task Height	Standard Upholstery	SH	03	28		19W x 57D x 18H	2.1	1,996	2,172	2,270	2,367	2,463	2,560	2,666	2,771	2,898	3,060	3,252	3,333	3,516	3,669
	Mono-Color Waterline	SH	03	28	U1	19W x 57D x 18H	2.2	2,227	2,411	2,512	2,614	2,715	2,816	2,929	3,040	3,171	3,340	3,541	3,628	3,820	3,980
	Dual-Color Waterline	SH	03	28	U2	19W x 57D x 18H	1.9 above Waterline 0.8 below Waterline	2,227	2,452	2,578	2,702	2,829	2,948	3,089	3,227	3,385	3,591	3,842	3,946	4,182	4,378

To Order Select Below

1. Series/Type/Seat

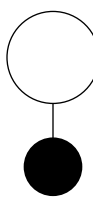

SH0326
Share End Cap, Double Narrow +, Lounge Height

SH0328
Share End Cap, Double Narrow +, Task Height

2. Leg

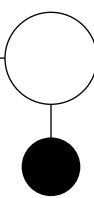

Leg

- L1 CORNER LEG, ADJ. PLASTIC GLIDES
- L2 ROUND LEG, ADJ. PLASTIC GLIDES
- L3 WOOD LEG

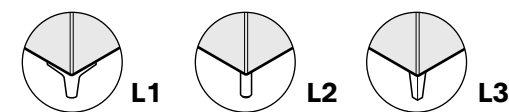

Mobility

The round leg glide has a larger diameter (1") than the corner leg for easier sliding on low pile carpet. Stylex is not responsible for damage to carpeting or floors.

3. Leg Finish

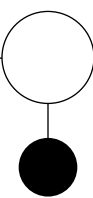

Standard Powder Coated Metal

- BL BLUE
- BM BLACK MATTE
- CP CHAMPAGNE
- DB DARK BRONZE
- DG DARK GRAY
- DP DUSTY PINK
- DS DARK SAGE
- LG LIGHT GRAY
- LL LILAC GRAY
- LP LIGHT PISTACHIO
- LR LIPSTICK RED
- MB MIDNIGHT BLUE

- MG MEADOW GREEN
- MK MILK
- MS METALLIC SILVER
- NK NICKEL
- OC OCHRE
- PY PALE YELLOW
- RO RED ORANGE
- RR RUSTY RED
- SB SOFT BLUE
- SD SAND
- TC TERRACOTTA
- TP TAUPE

4. Options

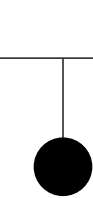

Polished Aluminum

- AL POLISHED ALUMINUM

Wood Finish +224

- 81 WHITE OAK
- 83 NATURAL MAPLE
- 85 WALNUT

Custom Color Match

- 09 CUSTOM COLOR

Per order per color - 20 chair minimum.
Contact customer service for details.

4. Options

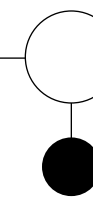

Ganging

- SG GANGING **+53**

Used to connect chairs to adjacent chairs or benches.

Power

- C1X IN-SEAT POWER PORT W/10' CORD **+452**
- C2X IN-SEAT POWER PORT W/20' CORD **+485**

See [page 7](#) for power port spec info.

Power Port Finish

Power ports can be finished in any standard powder coat available.

5. Upholstery Style

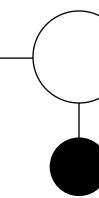

Upholstery Style

- U1 MONO-COLOR WATERLINE
- U2 DUAL-COLOR WATERLINE

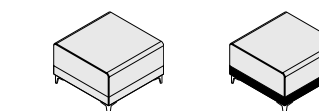

U1 U2

When pricing models with more than one fabric, the higher grade fabric will determine the overall grade of the specific product.

6. Upholstery

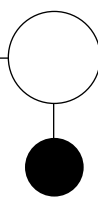

Upholstery

See general information section for details on textile program and COM/COL information.

Share will develop comfort wrinkles over time. The extent of these wrinkles is determined by the fabric specified.

Share

END CAP: DOUBLE WIDE

Textile Upholstery Grades

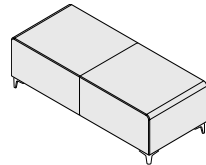
TITLE	SERIES	TYPE	SEAT	UPH	DIMENSIONS	YDG	COM	A	B	C	D	E	F	G	H	I	J	K	L	M	
End Cap, Double Wide, Lounge Height 	Standard Upholstery	SH	03	46	19W x 56D x 16H	2.8	2,227	2,462	2,592	2,720	2,846	2,976	3,119	3,262	3,429	3,643	3,901	4,009	4,254	4,458	
	Mono-Color Waterline	SH	03	46	U1	19W x 56D x 16H	2.4	2,494	2,696	2,805	2,918	3,027	3,139	3,261	3,381	3,525	3,712	3,931	4,022	4,232	4,406
	Dual-Color Waterline	SH	03	46	U2	19W x 56D x 16H	2 above Waterline 0.8 below Waterline	2,494	2,728	2,860	2,988	3,117	3,245	3,387	3,530	3,696	3,911	4,170	4,276	4,521	4,726
End Cap, Double Wide, Task Height	Standard Upholstery	SH	03	48	19W x 56D x 18H	2.9	2,227	2,468	2,604	2,737	2,870	3,006	3,151	3,298	3,470	3,692	3,960	4,073	4,326	4,538	
	Mono-Color Waterline	SH	03	48	U1	19W x 56D x 18H	2.6	2,494	2,713	2,833	2,954	3,071	3,191	3,323	3,455	3,612	3,808	4,050	4,150	4,376	4,567
	Dual-Color Waterline	SH	03	48	U2	19W x 56D x 18H	2.2 above Waterline 0.8 below Waterline	2,494	2,749	2,885	3,023	3,162	3,300	3,451	3,603	3,785	4,013	4,289	4,404	4,666	4,885

To Order Select Below

1. Series/Type/Seat

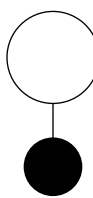

SH0346

Share
End Cap, Double Wide,
Lounge Height

SH0348

Share
End Cap, Double Wide,
Task Height

2. Leg

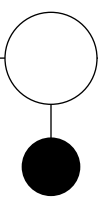

Leg

L1 CORNER LEG, ADJ. PLASTIC GLIDES

L2 ROUND LEG, ADJ. PLASTIC GLIDES

L3 WOOD LEG

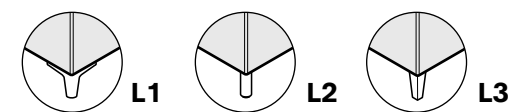

Mobility

The round leg glide has a larger diameter (1") than the corner leg for easier sliding on low pile carpet. Stylex is not responsible for damage to carpeting or floors.

3. Leg Finish

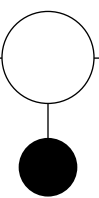

Standard Powder Coated Metal

BL BLUE

BM BLACK MATTE

CP CHAMPAGNE

DB DARK BRONZE

DG DARK GRAY

DP DUSTY PINK

DS DARK SAGE

LG LIGHT GRAY

LL LILAC GRAY

LP LIGHT PISTACHIO

LR LIPSTICK RED

MB MIDNIGHT BLUE

MG MEADOW GREEN

MK MILK

MS METALLIC SILVER

NK NICKEL

OC OCHRE

PY PALE YELLOW

RO RED ORANGE

RR RUSTY RED

SB SOFT BLUE

SD SAND

TC TERRACOTTA

TP TAUPE

4. Options

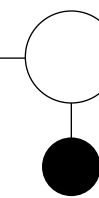

Ganging

SG GANGING **+53**

Used to connect chairs to adjacent chairs or benches.

Power

IN-SEAT POWER
C1X PORT W/10' CORD **+452**

IN-SEAT POWER
C2X PORT W/20' CORD **+485**

See [page 7](#) for power port spec info.

Power Port Finish

Power ports can be finished in any standard powder coat available.

5. Upholstery Style

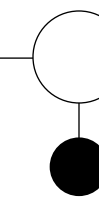

Upholstery Style

U1 MONO-COLOR WATERLINE

U2 DUAL-COLOR WATERLINE

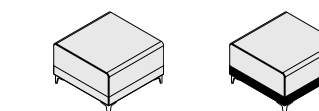

U1

U2

When pricing models with more than one fabric, the higher grade fabric will determine the overall grade of the specific product.

6. Upholstery

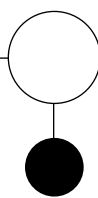

Upholstery

See general information section for details on textile program and COM/COL information.

Share will develop comfort wrinkles over time. The extent of these wrinkles is determined by the fabric specified.

Share

END CAP: DOUBLE WIDE +

Textile Upholstery Grades

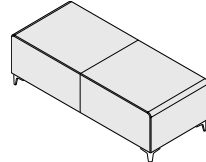
TITLE		SERIES	TYPE	SEAT	UPH	DIMENSIONS	YDG	COM	A	B	C	D	E	F	G	H	I	J	K	L	M
 End Cap, Double Wide +, Lounge Height	Standard Upholstery	SH	03	56		19W x 57D x 16H	2.9	2,302	2,547	2,681	2,815	2,946	3,082	3,229	3,376	3,547	3,772	4,037	4,148	4,401	4,612
	Mono-Color Waterline	SH	03	56	U1	19W x 57D x 16H	2.5	2,570	2,783	2,896	3,011	3,127	3,242	3,370	3,495	3,644	3,837	4,066	4,161	4,379	4,562
	Dual-Color Waterline	SH	03	56	U2	19W x 57D x 16H	2.1 above Waterline 0.9 below Waterline	2,570	2,825	2,963	3,100	3,238	3,377	3,529	3,681	3,859	4,091	4,365	4,480	4,742	4,961
End Cap, Double Wide +, Task Height	Standard Upholstery	SH	03	58		19W x 57D x 18H	3	2,302	2,554	2,694	2,832	2,971	3,106	3,261	3,411	3,588	3,821	4,098	4,212	4,474	4,692
	Mono-Color Waterline	SH	03	58	U1	19W x 57D x 18H	2.6	2,570	2,790	2,910	3,028	3,150	3,270	3,402	3,534	3,688	3,888	4,127	4,226	4,452	4,643
	Dual-Color Waterline	SH	03	58	U2	19W x 57D x 18H	2.2 above Waterline 0.9 below Waterline	2,570	2,833	2,975	3,117	3,261	3,404	3,559	3,718	3,902	4,141	4,427	4,544	4,814	5,041

To Order Select Below

1. Series/Type/Seat

SH0356

Share
End Cap, Double Wide +,
Lounge Height

SH0358

Share
End Cap, Double Wide +,
Task Height

2. Leg

Leg

L1 CORNER LEG, ADJ. PLASTIC GLIDES
L2 ROUND LEG, ADJ. PLASTIC GLIDES
L3 WOOD LEG

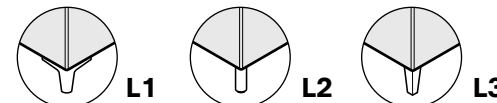

Mobility
The round leg glide has a larger diameter (1") than the corner leg for easier sliding on low pile carpet. Stylex is not responsible for damage to carpeting or floors.

3. Leg Finish

Standard Powder Coated Metal

BL BLUE
BM BLACK MATTE
CP CHAMPAGNE
DB DARK BRONZE
DG DARK GRAY
DP DUSTY PINK
DS DARK SAGE
LG LIGHT GRAY
LL LILAC GRAY
LP LIGHT PISTACHIO
LR LIPSTICK RED
MB MIDNIGHT BLUE

MG MEADOW GREEN
MK MILK
MS METALLIC SILVER
NK NICKEL
OC OCHRE
PY PALE YELLOW
RO RED ORANGE
RR RUSTY RED
SB SOFT BLUE
SD SAND
TC TERRACOTTA
TP TAUPE

4. Options

Ganging

SG GANGING **+53**

Used to connect chairs to adjacent chairs or benches.

Power

C1X IN-SEAT POWER PORT W/10' CORD **+452**
C2X IN-SEAT POWER PORT W/20' CORD **+485**

See [page 7](#) for power port spec info.

Power Port Finish
Power ports can be finished in any standard powder coat available.

5. Upholstery Style

Upholstery Style

U1 MONO-COLOR WATERLINE
U2 DUAL-COLOR WATERLINE

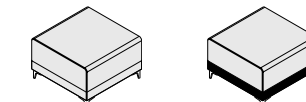

U1 **U2**

When pricing models with more than one fabric, the higher grade fabric will determine the overall grade of the specific product.

6. Upholstery

Upholstery

See general information section for details on textile program and COM/COL information.

Share will develop comfort wrinkles over time. The extent of these wrinkles is determined by the fabric specified.

Share

KNEE WALL: 24H

Textile Upholstery Grades

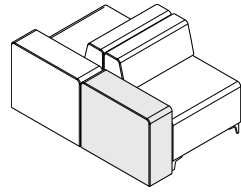
TITLE		SERIES	TYPE	SEAT	UPH	DIMENSIONS	YDG	COM	A	B	C	D	E	F	G	H	I	J	K	L	M	
	Knee Wall, 24 Low	Standard Upholstery	SH	24	1		9W x 28D x 24H	1.6	1,076	1,208	1,283	1,356	1,431	1,502	1,586	1,667	1,761	1,884	2,034	2,095	2,235	2,351
		Mono-Color Waterline	SH	24	1	U1	9W x 28D x 24H	1.5	1,267	1,395	1,462	1,531	1,602	1,669	1,745	1,822	1,912	2,025	2,163	2,221	2,352	2,463
		Dual-Color Waterline	SH	24	1	U2	9W x 28D x 24H	0.9 above Waterline 0.6 below Waterline	1,267	1,395	1,462	1,531	1,602	1,669	1,745	1,822	1,912	2,025	2,163	2,221	2,352	2,463
	Knee Wall, 24 Low +	Standard Upholstery	SH	24	2		9W x 28.5D x 24H	1.6	1,076	1,208	1,283	1,356	1,431	1,502	1,586	1,667	1,761	1,884	2,034	2,095	2,235	2,351
		Mono-Color Waterline	SH	24	2	U1	9W x 28.5D x 24H	1.5	1,267	1,395	1,462	1,531	1,602	1,669	1,745	1,822	1,912	2,025	2,163	2,221	2,352	2,463
		Dual-Color Waterline	SH	24	2	U2	9W x 28.5D x 24H	0.9 above Waterline 0.6 below Waterline	1,267	1,395	1,462	1,531	1,602	1,669	1,745	1,822	1,912	2,025	2,163	2,221	2,352	2,463

To Order Select Below

1. Series/Type/Seat

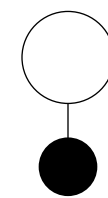

SH241

Share
Knee Wall, 24H Low

SH242

Share
Knee Wall, 24H Low +

2. Location

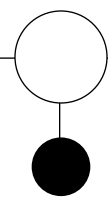

Location

L LEFT HAND
R RIGHT HAND
M MIDDLE

Knee walls include required ganging.
They must be specified left, right or middle.

Location is from the seated perspective.

3. Power Port

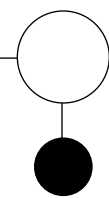

Power Port

P10 9' POWER CORD **+500**
P20 19' POWER CORD **+580**

Knee Wall Flip Out Power
Soft Touch Anodized Cover
1 Grounded 3-Prong
Electrical Outlet
1 USB 2.1A Port

4. Upholstery Style

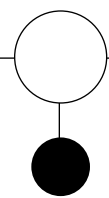

Upholstery Style

U1 MONO-COLOR WATERLINE
U2 DUAL-COLOR WATERLINE

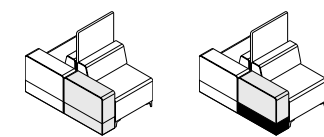

U1

U2

When pricing models with more than one fabric, the higher grade fabric will determine the overall grade of the specific product.

5. Upholstery

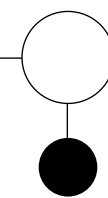

Upholstery

See general information section for details on textile program and COM/COL information.

Share will develop comfort wrinkles over time. The extent of these wrinkles is determined by the fabric specified.

Share

KNEE WALL: 29H

Textile Upholstery Grades

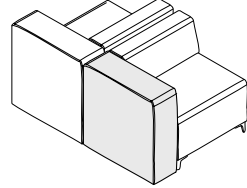
TITLE		SERIES	TYPE	SEAT	UPH	DIMENSIONS	YDG	COM	A	B	C	D	E	F	G	H	I	J	K	L	M
 Knee Wall, 29 High	Standard Upholstery	SH	29	1		9W x 28D x 29H	1.7	1,151	1,295	1,373	1,451	1,530	1,608	1,694	1,782	1,882	2,010	2,168	2,234	2,383	2,506
	Mono-Color Waterline	SH	29	1	U1	9W x 28D x 29H	2	1,342	1,513	1,604	1,697	1,787	1,880	1,980	2,083	2,202	2,356	2,540	2,615	2,789	2,936
	Dual-Color Waterline	SH	29	1	U2	9W x 28D x 29H	1.4 above Waterline 0.6 below Waterline	1,342	1,513	1,604	1,697	1,787	1,880	1,980	2,083	2,202	2,356	2,540	2,615	2,789	2,936
Knee Wall, 29 High +	Standard Upholstery	SH	29	2		9W x 28.5D x 29H	1.7	1,151	1,295	1,373	1,451	1,530	1,608	1,694	1,782	1,882	2,010	2,168	2,234	2,383	2,506
	Mono-Color Waterline	SH	29	2	U1	9W x 28.5D x 29H	2	1,342	1,513	1,604	1,697	1,787	1,880	1,980	2,083	2,202	2,356	2,540	2,615	2,789	2,936
	Dual-Color Waterline	SH	29	2	U2	9W x 28.5D x 29H	1.4 above Waterline 0.6 below Waterline	1,342	1,513	1,604	1,697	1,787	1,880	1,980	2,083	2,202	2,356	2,540	2,615	2,789	2,936

To Order Select Below

1. Series/Type/Seat

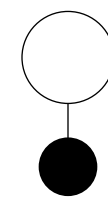

SH291

Share
Knee Wall, 29 High

SH292

Share
Knee Wall, 29 High +

2. Location

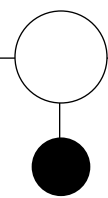

Location

- L LEFT HAND
- R RIGHT HAND
- M MIDDLE

Knee walls include required ganging.
They must be specified left, right or middle.

Location is from the seated perspective.

3. Power Port

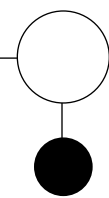

Power Port

- P10 9' POWER CORD **+500**
- P20 19' POWER CORD **+580**

Knee Wall Flip Out Power
Soft Touch Anodized Cover
1 Grounded 3-Prong
Electrical Outlet
1 USB 2.1A Port

4. Upholstery Style

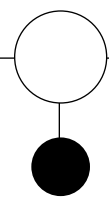

Upholstery Style

- U1 MONO-COLOR WATERLINE
- U2 DUAL-COLOR WATERLINE

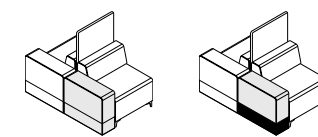

U1 **U2**

When pricing models with more than one fabric, the higher grade fabric will determine the overall grade of the specific product.

5. Upholstery

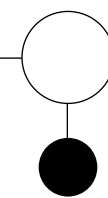

Upholstery

See general information section for details on textile program and COM/COL information.

Share will develop comfort wrinkles over time. The extent of these wrinkles is determined by the fabric specified.

Share

ARM

Textile Upholstery Grades

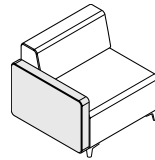
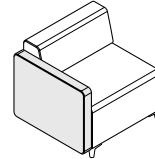
TITLE	SERIES	TYPE	SEAT	UPH	DIMENSIONS	YDG	COM	A	B	C	D	E	F	G	H	I	J	K	L	M	
	Standard Upholstery	SH	54	6	4W x 28D x 20H	2.1	446	625	722	816	914	1,009	1,117	1,224	1,350	1,512	1,706	1,826	2,009	2,146	
	Mono-Color Waterline	SH	54	6	U1	4W x 28D x 20H	1.8	625	780	861	943	1,025	1,110	1,198	1,292	1,399	1,537	1,704	1,797	1,957	2,071
	Dual-Color Waterline	SH	54	6	U2	4W x 28D x 20H	1.8 above Waterline 0.9 below Waterline	625	856	980	1,099	1,225	1,351	1,487	1,623	1,785	1,994	2,243	2,314	2,560	2,741
	Standard Upholstery	SH	56	8	4W x 28D x 22H	2.2	446	625	722	816	914	1,009	1,117	1,224	1,350	1,512	1,706	1,826	2,009	2,146	
	Mono-Color Waterline	SH	56	8	U1	4W x 28D x 22H	1.9	625	780	861	943	1,025	1,110	1,198	1,292	1,399	1,537	1,704	1,797	1,957	2,071
	Dual-Color Waterline	SH	56	8	U2	4W x 28D x 22H	1.9 above Waterline 0.9 below Waterline	625	856	980	1,099	1,225	1,351	1,487	1,623	1,785	1,994	2,243	2,314	2,560	2,741

To Order Select Below

1. Series/Type/Seat

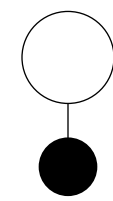

SH546

**Share
Arm, 24H**

SH568

**Share
Arm, 26H**

24H Arms are for Lounge Height Seats.
26H Arms are for Task Height Seats.

The 24H arm and 26H arm are primarily intended to be used to create club chairs, loveseats, and sofas based on the modular one, two, and three seat units.

2. Arm Location

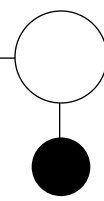

Arm Location

L LEFT HAND

R RIGHT HAND

M MID

Location is from the seated perspective.

3. Upholstery Style

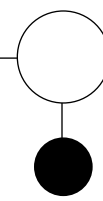

Upholstery Style

U1 MONO-COLOR WATERLINE

U2 DUAL-COLOR WATERLINE

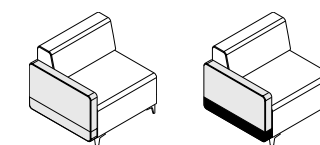

U1

U2

When pricing models with more than one fabric, the higher grade fabric will determine the overall grade of the specific product.

4. Upholstery

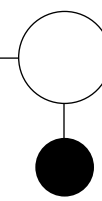

Upholstery

See general information section for details on textile program and COM/COL information.

Share will develop comfort wrinkles over time. The extent of these wrinkles is determined by the fabric specified.

Share

ROUND OTTOMAN

Textile Upholstery Grades

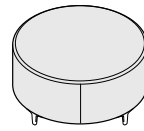
TITLE		SERIES	TYPE	SEAT	UPH	DIMENSIONS	YDG	COM	A	B	C	D	E	F	G	H	I	J	K	L	M
 Round Ottoman, Lounge Height	Standard Upholstery	SH	04	86		36D x 16H	3.4	2,921	2,944	3,105	3,264	3,428	3,593	3,773	3,951	4,164	4,439	4,764	4,897	5,205	5,522
	Mono-Color Waterline	SH	04	86	U1	36D x 16H	3.4	2,921	3,223	3,386	3,544	3,709	3,874	4,052	4,230	4,442	4,717	5,044	5,167	5,475	5,791
	Dual-Color Waterline	SH	04	86	U2	36D x 16H	2.6 above Waterline 1 below Waterline	2,921	3,240	3,413	3,582	3,754	3,927	4,118	4,309	4,533	4,824	5,169	5,305	5,634	5,966
Round Ottoman, Task Height	Standard Upholstery	SH	04	88		36D x 18H	3.6	2,921	3,038	3,212	3,379	3,553	3,727	3,916	4,107	4,328	4,622	4,967	5,110	5,439	5,772
	Mono-Color Waterline	SH	04	88	U1	36D x 18H	3.6	2,921	3,318	3,491	3,660	3,831	4,004	4,193	4,386	4,610	4,899	5,248	5,378	5,706	6,040
	Dual-Color Waterline	SH	04	88	U2	36D x 18H	2.8 above Waterline 1 below Waterline	3,698	4,035	4,217	4,394	4,578	4,760	4,962	5,163	5,398	5,705	6,070	6,189	6,536	6,889

To Order Select Below

1. Series/Type/Seat

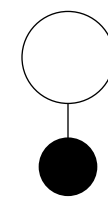

SH0486

Share Round Ottoman, Lounge Height

SH0488

Share Round Ottoman, Task Height

2. Leg

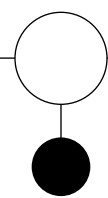

Leg

L1 CORNER LEG, ADJ. PLASTIC GLIDES

L2 ROUND LEG, ADJ. PLASTIC GLIDES

L3 WOOD LEG

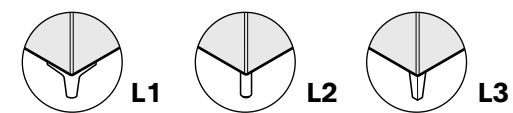

Mobility

The round leg glide has a larger diameter (1") than the corner leg for easier sliding on low pile carpet. Stylex is not responsible for damage to carpeting or floors.

3. Leg Finish

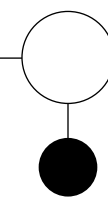

Standard Powder Coated Metal

BL BLUE

BM BLACK MATTE

CP CHAMPAGNE

DB DARK BRONZE

DG DARK GRAY

DP DUSTY PINK

DS DARK SAGE

LG LIGHT GRAY

LL LILAC GRAY

LP LIGHT PISTACHIO

LR LIPSTICK RED

MB MIDNIGHT BLUE

MG MEADOW GREEN

MK MILK

MS METALLIC SILVER

NK NICKEL

OC OCHRE

PY PALE YELLOW

RO RED ORANGE

RR RUSTY RED

SB SOFT BLUE

SD SAND

TC TERRACOTTA

TP TAUPE

4. Upholstery Style

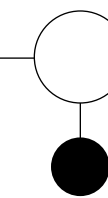

Upholstery Style

U1 MONO-COLOR WATERLINE

U2 DUAL-COLOR WATERLINE

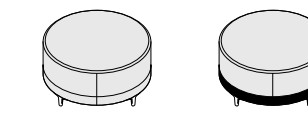

U1

U2

When pricing models with more than one fabric, the higher grade fabric will determine the overall grade of the specific product.

5. Upholstery

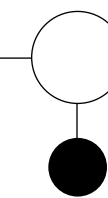

Upholstery

See general information section for details on textile program and COM/COL information.

Share will develop comfort wrinkles over time. The extent of these wrinkles is determined by the fabric specified.

Share

ACCESSORIES: CUBE SEAT

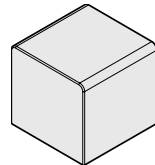
								Textile Upholstery Grades													
TITLE		SERIES	TYPE	SEAT	UPH	DIMENSIONS	YDG	COM	A	B	C	D	E	F	G	H	I	J	K	L	M
 Accessories, Cube Seat, Lounge Height	Standard Upholstery	SH	41	06		19W x 19D x 16H	1.4	920	1,038	1,104	1,167	1,231	1,296	1,369	1,439	1,524	1,631	1,757	1,812	1,934	2,036
	Mono-Color Waterline	SH	41	06	U1	19W x 19D x 16H	1	1,114	1,196	1,241	1,289	1,336	1,381	1,432	1,483	1,542	1,619	1,710	1,750	1,838	1,910
	Dual-Color Waterline	SH	41	06	U2	19W x 19D x 16H	1 above Waterline 0.4 below Waterline	1,114	1,229	1,295	1,361	1,426	1,489	1,560	1,631	1,715	1,822	1,949	2,005	2,128	2,230
Accessories, Cube Seat, Task Height	Standard Upholstery	SH	41	08		19W x 19D x 18H	1.5	920	1,048	1,117	1,185	1,256	1,324	1,400	1,477	1,566	1,681	1,819	1,875	2,006	2,116
	Mono-Color Waterline	SH	41	08	U1	19W x 19D x 18H	1.1	1,114	1,205	1,257	1,307	1,356	1,406	1,462	1,522	1,586	1,669	1,772	1,814	1,910	1,991
	Dual-Color Waterline	SH	41	08	U2	19W x 19D x 18H	1 above Waterline 0.4 below Waterline	1,114	1,239	1,308	1,375	1,447	1,515	1,592	1,667	1,754	1,873	2,009	2,005	2,128	2,230

To Order Select Below

1. Series/Type/Seat

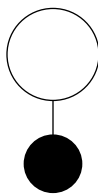

SH4106

**Share
Accessories, Cube Seat,
Lounge Height**

SH4108

**Share
Accessories, Cube Seat,
Task Height**

The light weight cube seat can be stowed along side other share pieces and easily moved as required.

2. Upholstery Style

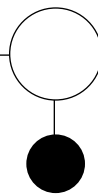

Upholstery Style

U1 MONO-COLOR WATERLINE

U2 DUAL-COLOR WATERLINE

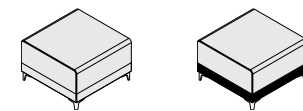

U1

U2

When pricing models with more than one fabric, the higher grade fabric will determine the overall grade of the specific product.

3. Upholstery

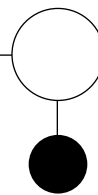

Upholstery

See general information section for details on textile program and COM/COL information.

Share will develop comfort wrinkles over time. The extent of these wrinkles is determined by the fabric specified.

Share

ACCESSORIES: PRIVACY SCREEN

Textile Upholstery Grades

TITLE	SERIES	TYPE	SEAT	UPH	DIMENSIONS	YDG	COM	A	B	C	D	E	F	G	H	I	J	K	L	M
Accessories, Privacy Screen	Standard Upholstery	SH	31	00	27W x 1.25D x 43H	1.6	769	903	976	1,050	1,123	1,196	1,278	1,361	1,455	1,577	1,724	1,787	1,927	2,044
					Overall Height: 47 Height Above Back: 18 Height Above Back on Banquette Chairs: 11															

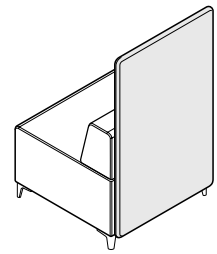

To Order Select Below

1. Series/Type/Seat/Height

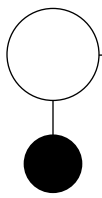

SH31006

**Share
Accessories, Privacy Screen,
Lounge Height**

SH31008

**Share
Accessories, Privacy Screen,
Task Height**

Important Information
Share privacy screens are field installed on chairs. Each seat takes one screen. Screens can be removed without damage to chair upholstery. To simplify screen installation brackets are pre-installed at the factory based on floor plans submitted with an order.

Note: Privacy screens are unavailable on curved units.

2. Upholstery Style

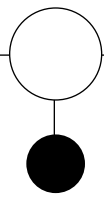

Upholstery Style

U1 MONO-COLOR WATERLINE

U2 DUAL-COLOR WATERLINE

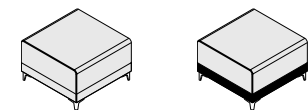

U1 U2

When pricing models with more than one fabric, the higher grade fabric will determine the overall grade of the specific product.

3. Upholstery

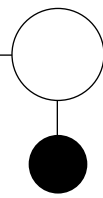

Upholstery

See general information section for details on textile program and COM/COL information.

Share will develop comfort wrinkles over time. The extent of these wrinkles is determined by the fabric specified.