

stylex

Sava

PRICE LIST
Effective January 17, 2024

General Information

STYLEX PRICE LIST

GENERAL INFORMATION

Terms

Net 30 days from date of invoice,
F. O. B . Delanco, New Jersey.

Damaged Shipments

All Stylex products are carefully inspected before they are packed in sturdy cartons designed to satisfy shipping requirements. Stylex is not responsible for damage in shipment. The transportation company assumes responsibility for delivering products to you in good condition when the bill of lading is signed. You protect yourself by refusing shipments showing damage or shortage until transportation company has noted on the delivery sheet the extent of damage or shortage. Concealed damage should be reported to the carrier as soon as discovered, but no later than 5 days after receiving shipment.

Return/Restocking Policy

Return shipments will not be accepted unless specifically authorized by Stylex in writing. The Return Authorization number should be clearly marked on the carton. The customer returning Stylex products is responsible for return shipping costs. Merchandise must be returned unused. Returned merchandise is subject to a 35% restocking fee.

Custom Products

Modifications to standard products will be considered for large runs. Contact factory for price quotations.

Design Changes

In keeping with modern manufacturing advances, Stylex reserves the right to incorporate minor modifications and design changes in products without notice.

Cancellation/Change Order Policy

Regarding requests for order cancellation and/or order modification, please be advised that no charges will be applied before production, unless inventory has been specifically requisitioned to fulfill your order. Once orders proceed to the production phase, they cannot be altered or canceled under any circumstances. All requests for order cancellations or order changes must be submitted in writing and will only be considered valid upon approval by Stylex.

WARRANTY

Except as provided below, Stylex warrants exclusively to the original Purchaser of our product that all parts, under normal use and service, will be free from defects in workmanship and material for a period of ten (10) years from the date of purchase. "Normal use and service" means that the product will be used in a typical office environment for 40-45 hours per week.

This warranty is subject to the following limitations, exclusions and provisions:

Limitations involving materials and components:

Wood components of plywood stacking chairs
(such as Brooks and Welcome)
5 years

Upholstery

(including mesh used for Click, F4, Insight, and Zephyr Mesh)
3 years

SAVA Mesh

10 years

COM Upholstery

No warranty
Stylex makes every effort to ensure that the COM Upholstery it approves is suitable for the intended use. Nevertheless, we will not warrant, and assume no responsibility for, the durability or tailoring quality of any COM or COL. If you have any concerns about the ultimate appearance of any covering, please order an upholstered sample.

Painted Stack Chair Frames

No Warranty

We will not warrant the finish of painted stack chair frames against damage from stacking. Please order chrome frames for chairs that will be stacked.

Felt Glides

No warranty

Due to the different surfaces on which felt glides may be used, we cannot warrant their durability over time.

If this product fails during normal use and service within the applicable warranty period (other than through normal wear and tear), please send a description of the relevant part and the nature of the defect, together with proof of purchase of the product to qm@stylexdesign.com. PLEASE DO NOT RETURN PARTS OR THE PRODUCT TO STYLEX UNLESS INSTRUCTED TO DO SO BY STYLEX. Stylex will, at its discretion, either repair or replace the defective product or part at no cost. Labor requests must receive approval and will be authorized on a case-by-case basis. We will only reimburse for labor costs directly incurred, excluding any travel-related expenses. Purchaser may be required (at the option of Stylex) to return to Stylex at Purchaser's expense any defective part with all freight or shipping charges prepaid. The foregoing warranty shall be void if the product has been altered or repaired (other than by Stylex). The warranty does not cover damage to the product caused by accident, neglect, misuse, abuse, modification to the product by anyone other than Stylex or damage caused by use of the product for a purpose other than that for which it was designed. This warranty extends only to the original Purchaser of the product.

No Other Warranties

This warranty is in lieu of all other warranties, expressed or implied, including, but not limited to, implied warranties of merchantability and fitness for a particular purpose. The rights and remedies provided herein are the exclusive rights and remedies of the original purchaser of the product.

No Liability For Damages

In no event shall Stylex or its suppliers be responsible or liable for any special, indirect, consequential, or incidental damages. In no event shall the liability of Stylex exceed the actual purchase price paid to Stylex for the product.

Out of Warranty Products

For all products no longer covered by our warranty, please refer to our Design for Durability and Upgradability Policy. Contact Customer Service if you would like to purchase any replaceable components to further extend the life of any Stylex seating product. This warranty applies to all Stylex products purchased on April 13, 2018, and thereafter.

PRODUCT TAKE BACK PROGRAM

In order to be good stewards of our products, Stylex offers a pathway towards a Product Take Back Program as a more viable solution to the end of our products' originally intended life.

Stylex supports the sustainable programs of ANEW and offers their added value to our clients through a comprehensive take-back solution for surplus office furniture and materials of any kind, in any condition. ANEW is a 501(c)(3) non-profit organization that exists to provide companies with smart, cost effective alternatives for their surplus furniture and other items with the priority of matching it to non-profits, public agencies and the underserved, within the local community of the project site. Corporate Social Responsibility is raised while the impact on the environment is lowered by diverting products and materials otherwise destined for landfill.

Stylex is proud to offer ANEW to customers dedicated to strengthening their community network by repurposing their furniture, fixtures and architectural materials to those in need. In 2014, Stylex committed to making this relationship a part of our strategic sales strategy. Visit www.anewfound.org to find out more.

To initiate a Product Take Back strategy through ANEW, contact Stylex Customer Service at 800-257-5742.

For other end of life recovery options, please see our Product Disassembly Instructions and End of Life Recovery Options documents available on our website in the resources section of each product in our line.

FREIGHT PROGRAM

Freight charges will be calculated as a percentage of the net product price and added to the invoice at the time of shipment. The continental United States has been divided into three zones. Please use the map below to determine freight charges for the product's destination. Minimum freight charge is \$150. Please let us know if you will be shipping to a residential address or require inside delivery as this requires an additional fee. Also please note we need to be made aware if a liftgate is required prior to delivery. If any requests are made at the time of delivery, applicable charges will apply.



ZONE 1 - 4%

Connecticut
Delaware
New York
New Jersey
Maryland
Massachusetts
North Carolina
Ohio
Pennsylvania
Rhode Island
Virginia
Washington D.C.
West Virginia

ZONE 2 - 5%

Alabama
Arkansas
Canada, Ontario
Canada, Quebec
Florida
Georgia
Iowa
Illinois
Indiana
Kansas
Kentucky
Louisiana
Nebraska
New Hampshire
Oklahoma
Maine
Michigan
Minnesota
Missouri
Mississippi
South Carolina
Tennessee
Texas
Vermont
Wisconsin

ZONE 3 - 6%

Arizona
California
Colorado
Idaho
Montana
Nevada
New Mexico
North Dakota
Oregon
South Dakota
Utah
Washington
Wyoming

Quote Per Project

Alaska
Hawaii
Canada
(outside Ontario & Quebec)
Mexico

General Information

STYLEX PRICE LIST

TEXTILE PARTNERS & APPROVALS

Textile Partners

To customize your furniture performance needs and design vision, Stylex offers a wide selection of in-graded leathers and textiles from Grades A through Y. We've partnered with leading manufacturers on the options, focusing on color, price, durability, and construction. To view our partners and explore our digital carded program with broadly approved textiles, visit [this page](#). We stand by these textiles: They're tried and tested, and will effortlessly fit into any design aesthetic.

Textile Approvals

All textiles must be approved for the product you are specifying. For the related approved textile lists, visit [this page](#).

CAL 117 AND 133 COMPLIANCE

CAL 117-2013

All Stylex seating satisfies the requirements of CAL 117-2013 so long as one of our standard or in-graded fabrics is applied. COM textiles cannot be so guaranteed. Please contact the supplier of COM's directly to determine the fire retardancy of any COM supplied to us.

CAL 133

Most Stylex seating can be ordered to meet the requirements of CAL 133. When ordering, simply specify "CAL 133 compliance required". The upcharge for this option is \$54 list per yard. Please refer to the COM yardage of each model to determine the number of yards required. We do frequently require full-scale burn tests in order to certify CAL 133 before an order will be accepted. Such burn tests may increase normal lead times and do carry additional charges. Please contact customer service for details.

CUSTOMER'S OWN MATERIAL/LEATHER

Customer's own material (COM) and customer's own leather (COL) will generally be upholstered at the price designated in each product's price list. Please be advised, however, that we specifically reserve the right to charge a higher price when we determine that special circumstances, such as unusual repeats or challenging materials, present themselves. All orders for custom coverings must be approved by Stylex before they will be accepted for production. To submit proposed textile for approval, please use the COM form [here](#).

Special Note:

We assume no responsibility for the durability or tailoring quality of any COM or COL. Directional covers in particular may not meet your satisfaction due to the design of certain products. Please be advised that COM and COL orders are not subject to return. If you have doubts about the ultimate appearance of certain coverings, please order a sample done with that specific COM or COL. In addition, while we inspect fabrics for mill imperfections, some are difficult to recognize. We cannot be responsible for defects, color inaccuracies, dye lot variations, or other flaws.

Under no circumstances will we be responsible for COM shortages, flaws, or other such problems. Finally, it is not our responsibility to police the receipt of COM's in order to meet delivery deadlines, and we assume our customers are aware of any undue delay in the shipment of their COM fabrics.

COM fabric and COL leather should be sent prepaid to: Stylex

**Attn: COM/COL - [Your PO #]
740 Coopertown Road
Delanco, NJ 08075**

Clearly mark fabric or leather with the dealers name, purchase order number, and furniture model number of the item to be covered. Actual furniture orders should include the same information, as well as a description of the fabric or leather, including pattern and color number, in order to provide a cross reference.

Yardage requirements shown in the price list are based on non-directional goods of 54" width. Fabrics less than 54" wide or those requiring matching (stripes, prints, or large patterned designs) call for additional yardage. We will be happy to supply yardage requirements for large quantities where economies may be realized.

Add the following yardage for stripes, plaids, or patterns with repeats:

Fabric Width	Plain Fabric	2-14" Repeat	15-24" Repeat	25-27" Repeat	28-36" Repeat
54"	0%	10%	15%	20%	25%
50"	10%	20%	25%	30%	35%
48"	15%	25%	30%	35%	40%
45"	40%	50%	55%	60%	65%
36"	50%	60%	65%	70%	75%

COM/COL FORM

To avoid delay in processing COM orders we request that you submit a sample of your COM fabric stapled to this form which can be downloaded [here](#). If a fabric has a stripe or design, the size of the repeat should be indicated. Please indicate the fabric supplier's name, fabric number, and color. Also indicate the Stylex product on which the fabric will be used.

The fabric supplier must indicate on his shipping labels the dealer name and purchase order number as well as the Stylex model number.

Please Note:

No order may be entered into production or have a shipping date assigned until all related COM is received at the factory.



CENTER OF STRIPE OR DESIGN

TOP OF CHAIR	TOP OF CHAIR
--------------	--------------

1. Size of Repeat

2. Fabric Supplier

3. Fabric Number

4. Color

5. Stylex Product

Contents

<hr/>		<hr/>	
COLORS, MATERIALS, AND FINISHES	5	MEDIUM BACK: MESH BACK	9
STATEMENT OF LINE	6	MEDIUM BACK: STANDARD UPHOLSTERY BACK	15
DIMENSIONS	7	MEDIUM BACK: EURO UPHOLSTERY BACK	18
HOW TO ORDER	8	HIGH BACK	21
<hr/>		<hr/>	

CLICK THE TITLES ABOVE TO NAVIGATE THROUGH THE DOCUMENT
PRODUCT HEADERS ON SUBSEQUENT PAGES LINK BACK TO THIS PAGE

Sava

COLORS, MATERIALS, AND FINISHES

MESH COLORS

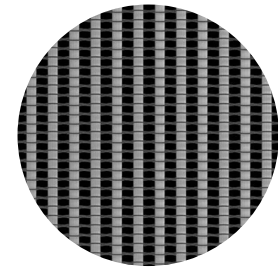

SILVER WHITE
(M3)

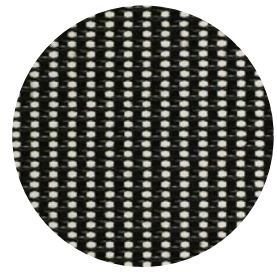

BLACK
(M1)

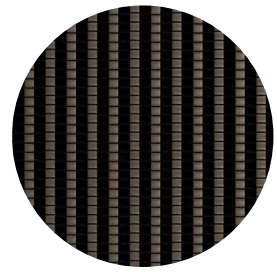

BRONZE
(M2)

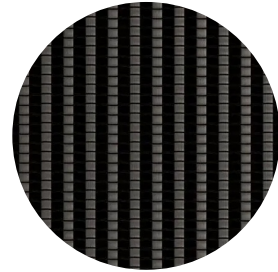

WARM GRAY
(M4)

POLISHED METAL

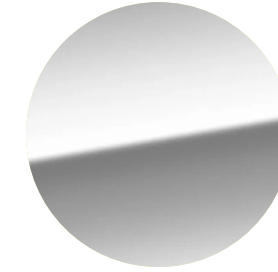



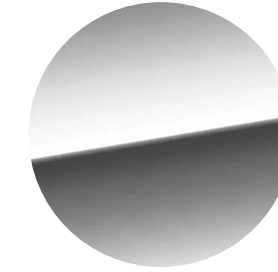





POLISHED
ALUMINUM
(AL)

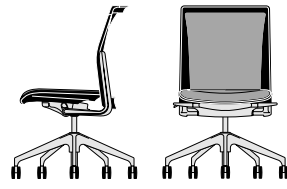
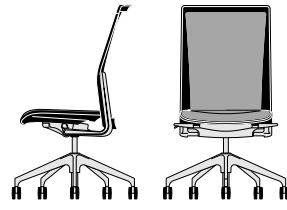
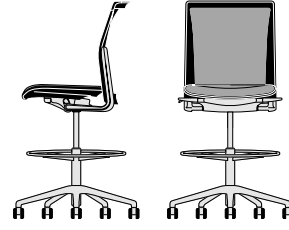
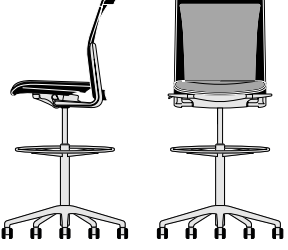
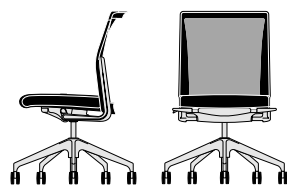
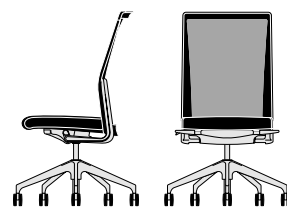
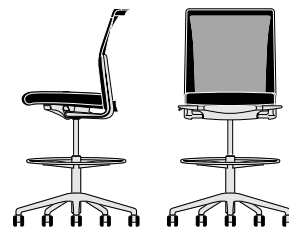
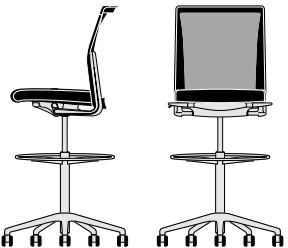
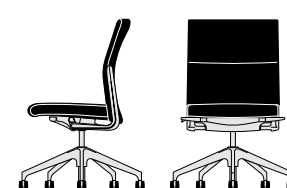
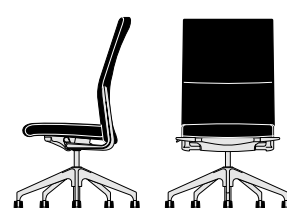
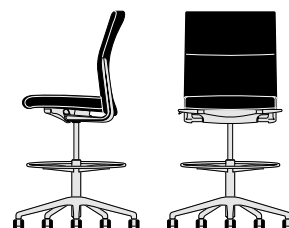
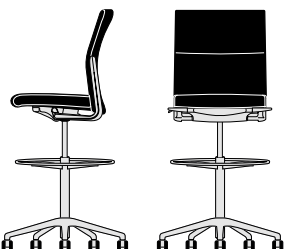

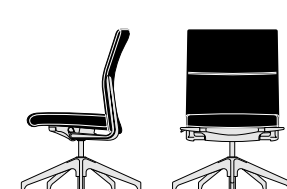
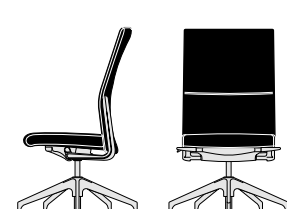

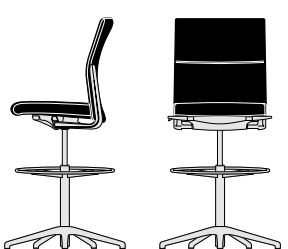
CHROME
(CH)

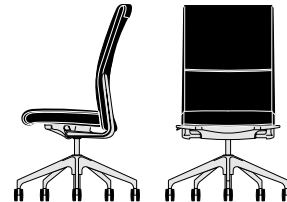
Sava

SPECIFICATION GUIDE: STATEMENT OF LINE

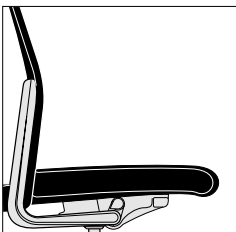
OVERVIEW	MEDIUM BACK CHAIR	HIGH BACK CHAIR	COUNTER STOOL	BAR STOOL
Mesh Back, Mesh Seat				
Mesh Back, Upholstered Seat				
Standard Upholstery Back, Upholstered Seat				
 Euro Upholstery Back, Euro Upholstery Seat				
 Thin Pad Back, Thin Pad Seat				
				

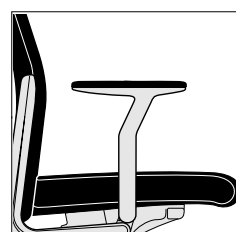
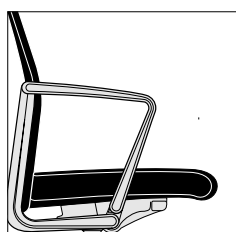
OPTION OVERVIEW	Armless	Height Adjustable Arm	Fixed Height T-Arm	Fixed-Height D-Arm
Arm Choices				

Options	Upholstered Arm Caps Black Plastic Arm Caps for D-Arm	Contrasting Thread for Upholstered Seats/Backs	Lumbar Support for Mesh Backs	Casters and Glide Options
----------------	--	--	-------------------------------	---------------------------

GENERAL INFORMATION

Design

Sava Cvek

Controls

On upholstered seats, multi-task control offers four adjustments – seat height, seat depth, tilt tension, and tilt lock. Conference models have two adjustments: seat height and tilt lock. Single Paddle mechanisms offer the same superior comfort as the multi-task control, but, other than seat height, they are not user-adjustable. All Sava chairs offer seat height adjustment lock-out. This function is user-friendly and may be easily adjusted in the field.

Back Supports

Back supports, attached to the control by metal fasteners, are aluminum.

Arms

Adjustable arms are primarily cast aluminum. Caps are self-skinned black polyurethane foam that may be optionally upholstered. Fixed T-arms are cast aluminum. Caps are self-skinned black polyurethane foam that may be optionally upholstered. Fixed D-arms are cast aluminum and may be specified with plastic caps. D-arms may be upholstered in leather, vinyl, or polyurethane.

Bases

Bases are cast aluminum.

Use

Designed for indoor use only.

Performance Standards

Manufactured to comply with:
ANSI/BIFMA X5.1 General-Purpose Office Chairs - Tests

Certifications

GREENGUARD Gold
LEVEL® 2

Sava

SPECIFICATION GUIDE: DIMENSIONS

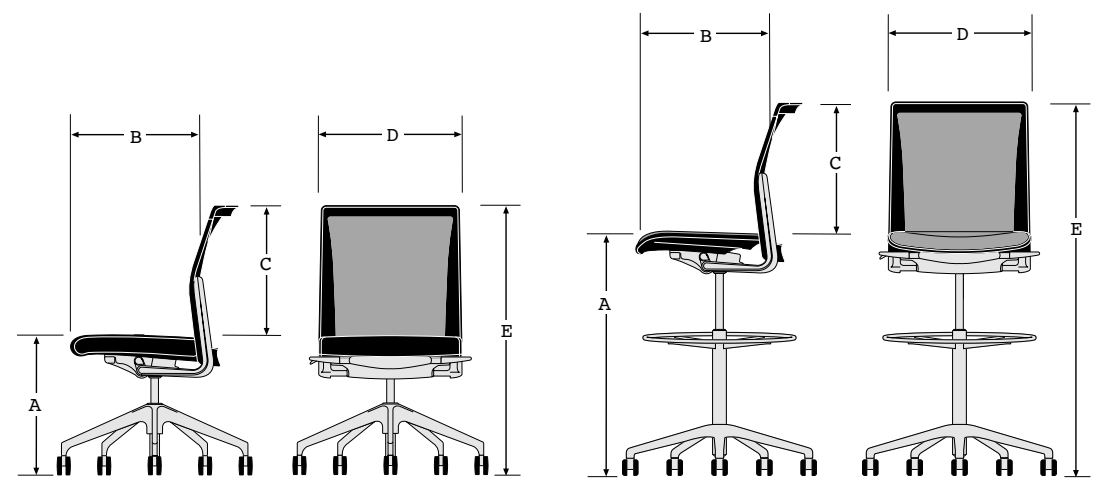
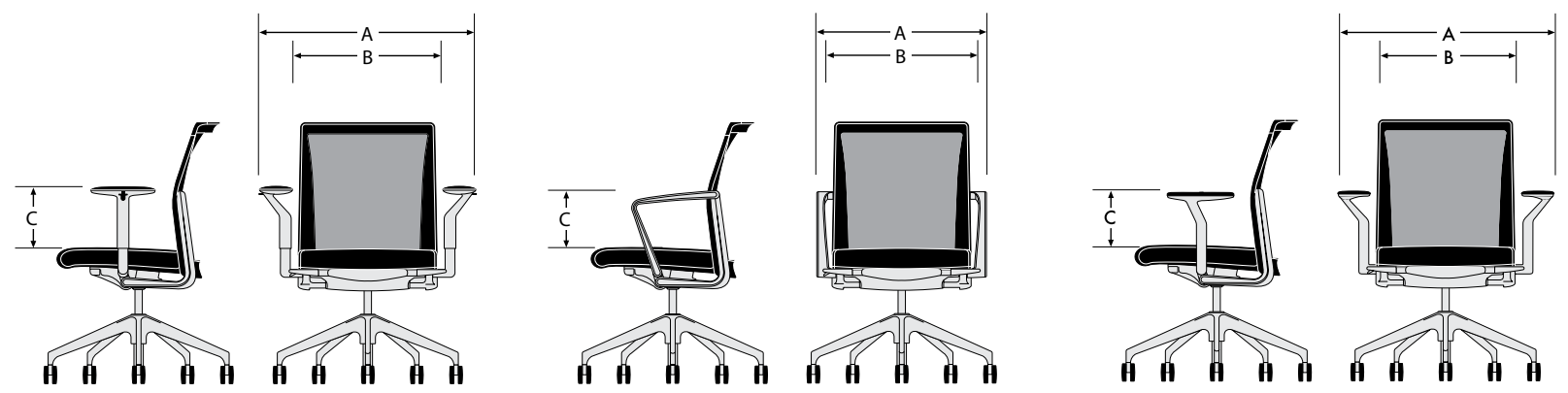
OVERVIEW	CHAIR		STOOL	
<p>Dimensions</p> <ul style="list-style-type: none"> A. Seat Height* B. Seat Depth C. Back Height D. Seat Width & Overall Width (Armless) E. Maximum Overall Height* <p>* Measurements given are for most controls, upholstered seats, and mesh backs. Specific models may vary slightly.</p> 	<p>Medium Back</p> <ul style="list-style-type: none"> A. 16-21 B. 16.5-18.5 C. 17.5 D. 19 E. 33-38 	<p>High Back</p> <ul style="list-style-type: none"> A. 16-21 B. 16.5-18.5 C. 22.5 D. 19 E. 37.5-42.5 	<p>Counter Stool</p> <ul style="list-style-type: none"> A. 21-28 B. 16.5-18.5 C. 17.5 D. 19 E. 38.5-45.5 	<p>Bar Stool</p> <ul style="list-style-type: none"> A. 23.25-33.25 B. 16.5-18.5 C. 17.5 D. 19 E. 40.75-50.75
<p>Arm Choice</p> <ul style="list-style-type: none"> A. Overall Width B. Distance Between Arms C. Arm Height 	<p>Height Adjustable Arm</p> <ul style="list-style-type: none"> A. 27.5 B. 20.5 C. 6-9 <p>Arms rotate inward 45°</p>	<p>Fixed Height D-Arm</p> <ul style="list-style-type: none"> A. 23.5 B. 21 C. 7.75 	<p>Fixed Height T-Arm</p> <ul style="list-style-type: none"> A. 27.5 B. 20.5 C. 7.5 	

Sava

SPECIFICATION GUIDE: HOW TO ORDER

MODEL CODE BREAKDOWN

Sample Model Code: **SV16105M305UCLUBSALCOM**

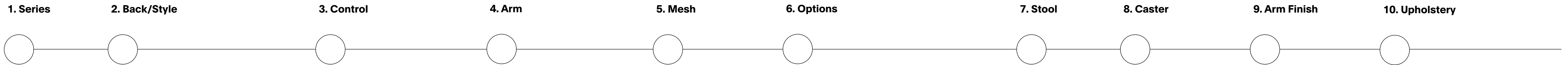

SV **16** **1** **05** **M3** **05UC LU** **~** **BS** **AL** **COM**



1. Series	2. Back/Style	3. Control	4. Arm	5. Mesh	6. Options	7. Stool	8. Caster	9. Arm Finish	10. Upholstery
Series SV SAVA	Medium Back 16 MESH BACK MESH SEAT 26 MESH BACK UPHOLSTERED SEAT 46 STANDARD UPHOLSTERED BACK UPHOLSTERED SEAT 56 EURO UPHOLSTERY BACK EURO UPHOLSTERY SEAT High Back 18 MESH BACK MESH SEAT 28 MESH BACK UPHOLSTERED SEAT 48 STANDARD UPHOLSTERED BACK UPHOLSTERED SEAT 58 EURO UPHOLSTERY BACK EURO UPHOLSTERY SEAT 78 THIN PAD BACK THIN PAD SEAT	Control 1 SINGLE PADDLE 2 CONFERENCE 4 MULTI-TASK (UPHOLSTERED SEAT)	Arm 00 ARMLESS 01 HEIGHT ADJUSTABLE ARM 05 FIXED HEIGHT T-ARM 07 FIXED HEIGHT D-ARM	Mesh M1 BLACK M2 BRONZE M3 SILVER WHITE M4 WARM GREY	Options 01UC UPHOLSTERED ARM CAPS FOR HEIGHT ADJUSTABLE ARMS 05UC UPHOLSTERED ARM CAPS FOR FIXED HEIGHT T-ARMS 07UC UPHOLSTERED ARM CAPS FOR FIXED HEIGHT D-ARMS AC BLACK PLASTIC ARM CAPS FOR FIXED HEIGHT D-ARMS LU ADJUSTABLE LUMBAR SUPPORT CT CONTRASTING THREAD <small>Adjustable lumbar support for mesh back chairs only. Upholstered arm caps must be leather, vinyl, or polyurethane. Height adjustment lock-out comes standard on all Sava chairs.</small>	Stool M COUNTER H BAR	Caster BC BLACK HARD WHEEL BS BLACK SOFT WHEEL CC CHROME TRIM CS CHROME TRIM SOFT WHEEL GA GLIDES W/ ABS PADS GF GLIDES W/ FELT PADS	Arm Finish AL POLISHED ALUMINUM BM BLACK MATTE CH CHROME <small>Black Matte finish is only available on the Single Paddle control. Black Matte finish on arms is only available on Fixed Height T-Arm (05) or D-Arm (07).</small> <small>Chrome finish is only available on Fixed Height D-Arms (07)</small>	Textile Grades COM CUSTOMER'S OWN MATERIAL A GRADE A B GRADE B C GRADE C D GRADE D E GRADE E F GRADE F G GRADE G H GRADE H I GRADE I J GRADE J K GRADE K L GRADE L M GRADE M Leather Grades COL CUSTOMER'S OWN LEATHER W GRADE W X GRADE X Y GRADE Y E1 GRADE E1 E2 GRADE E2

Sava

MEDIUM BACK: MESH BACK, MESH SEAT, CONFERENCE MECHANISM

TITLE	STYLE	CTRL	ARM	HEIGHT	DIMENSIONS	YDG	SQFT	Textile Upholstery Grades										Leather Upholstery Grades									
								COM	COL	COM	COL	A	B	C	D	E	F	G	H	I	J	K	L	M	W	X	Y
	Armless	SV16	2	00		19W x 26.5D x 33-38H	0	0	1847																		
		SV16	2	00	M	19W x 26.5D x 38.5-45.5H	0	0	2000																		
		SV16	2	00	H	19W x 26.5D x 40.75-50.75H	0	0	2000																		
	Adjustable Arm	SV16	2	01		27.5W x 26.5D x 33-38H	0	0	2294																		
		SV16	2	01	M	27.5W x 26.5D x 38.5-45.5H	0	0	2448																		
		SV16	2	01	H	27.5W x 26.5D x 40.75-50.75H	0	0	2448																		
	Fixed T-Arm	SV16	2	05		27.5W x 26.5D x 33-38H	0	0	2080																		
		SV16	2	05	M	27.5W x 26.5D x 38.5-45.5H	0	0	2233																		
		SV16	2	05	H	27.5W x 26.5D x 40.75-50.75H	0	0	2233																		
	Fixed D-Arm	SV16	2	07	0	23.5W x 26.5D x 33-38H	0	0	2010																		
		SV16	2	07	M	23.5W x 26.5D x 38.5-45.5H	0	0	2163																		
		SV16	2	07	H	23.5W x 26.5D x 40.75-50.75H	0	0	2163																		

To Order Select Below

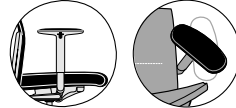
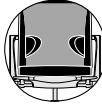

<p>1. Series/Back/Style</p> <p>SV16</p> <p>Sava Chair Medium Back, Mesh Back, Mesh Seat</p>	<p>2. Control</p> <p>2 CONFERENCE MECHANISM</p> <p>Adjustments Preset Recline Tension Pneumatic Seat Height Tilt Lock</p>	<p>3. Arm</p> <p>00 ARMLESS 01 HEIGHT ADJUSTABLE ARMS 05 FIXED HEIGHT T-ARM 07 FIXED HEIGHT D-ARM</p> <p> Armless  T-Arm  D-Arm</p> <p> Height Adjustable Arms</p> <p>Height adjustable arms come standard with 45° inward rotation and urethane caps.</p>	<p>4. Mesh</p> <p>M1 BLACK M2 BRONZE M3 SILVER WHITE M4 WARM GRAY</p>	<p>5. Options</p> <p>01UC UPHOLSTERED ARM CAP FOR HEIGHT ADJUSTABLE ARM +72</p> <p>05UC UPHOLSTERED ARM CAP FOR T-ARM +72</p> <p>07UC UPHOLSTERED ARM CAP FOR D-ARM +173</p> <p>AC BLACK PLASTIC ARM CAP FOR D-ARM +32</p> <p>LU ADJUSTABLE LUMBAR PADS +58</p> <p> Adjustable lumbar pads for Mesh Backs</p> <p>Upholstered arm caps must be leather, vinyl, or polyurethane. Height adjustment lock-out comes standard on all Sava chairs.</p>	<p>6. Stool</p> <p>M COUNTER STOOL H BAR STOOL</p> <p>Stool Heights available with Medium Back only.</p>	<p>7. Caster</p> <p>BC BLACK HARD WHEEL BS BLACK SOFT WHEEL +42 CC CHROME TRIM +98 CS CHROME TRIM SOFT WHEEL +123 GA GLIDES W/ABS PADS +98 GF GLIDES W/FELT PADS +98</p>	<p>8. Arm Finish</p> <p>AL POLISHED ALUMINUM CH CHROME +473</p> <p>Chrome finish is only available on Fixed Height D-Arms (07)</p>	<p>9. Upholstery</p> <p>See general information section for details on textile program and COM/ COL information.</p>
---	---	---	--	---	---	--	--	---

Sava

MEDIUM BACK: MESH BACK, MESH SEAT, SINGLE PADDLE MECHANISM

TITLE	STYLE	CTRL	ARM	HEIGHT	DIMENSIONS	YDG	SQFT	Textile Upholstery Grades										Leather Upholstery Grades									
								COM	COL	COM	COL	A	B	C	D	E	F	G	H	I	J	K	L	M	W	X	Y
 Medium Back, Mesh Back, Mesh Seat, Single Paddle Mechanism	Armless	SV16	1	00		19W x 26.5D x 33-38H	0	0	1570																		
		SV16	1	00	M	19W x 26.5D x 38.5-45.5H	0	0	1723																		
		SV16	1	00	H	19W x 26.5D x 40.75-50.75H	0	0	1723																		
	Adjustable Arm	SV16	1	01		27.5W x 26.5D x 33-38H	0	0	2016																		
		SV16	1	01	M	27.5W x 26.5D x 38.5-45.5H	0	0	2169																		
		SV16	1	01	H	27.5W x 26.5D x 40.75-50.75H	0	0	2169																		
	Fixed T-Arm	SV16	1	05		27.5W x 26.5D x 33-38H	0	0	1801																		
		SV16	1	05	M	27.5W x 26.5D x 38.5-45.5H	0	0	1954																		
		SV16	1	05	H	27.5W x 26.5D x 40.75-50.75H	0	0	1954																		
	Fixed D-Arm	SV16	1	07		23.5W x 26.5D x 33-38H	0	0	1730																		
		SV16	1	07	M	23.5W x 26.5D x 38.5-45.5H	0	0	1884																		
		SV16	1	07	H	23.5W x 26.5D x 40.75-50.75H	0	0	1884																		

To Order Select Below

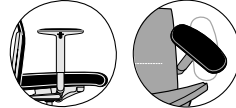
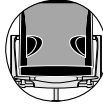

<p>1. Series/Back/Style</p> <p>SV16</p> <p>Sava Chair Medium Back, Mesh Back, Mesh Seat</p>	<p>2. Control</p> <p>1 SINGLE PADDLE MECHANISM</p> <p>Adjustments Preset Recline Tension Pneumatic Seat Height</p>	<p>3. Arm</p> <p>00 ARMLESS 01 HEIGHT ADJUSTABLE ARMS 05 FIXED HEIGHT T-ARM 07 FIXED HEIGHT D-ARM</p> <p> Armless  T-Arm  D-Arm</p> <p> Height Adjustable Arms</p> <p>Height adjustable arms come standard with 45° inward rotation and urethane caps.</p>	<p>4. Mesh</p> <p>M1 BLACK M2 BRONZE M3 SILVER WHITE M4 WARM GRAY</p>	<p>5. Options</p> <p>01UC UPHOLSTERED ARM CAP FOR HEIGHT ADJUSTABLE ARM +72</p> <p>05UC UPHOLSTERED ARM CAP FOR T-ARM +72</p> <p>07UC UPHOLSTERED ARM CAP FOR D-ARM +173</p> <p>AC BLACK PLASTIC ARM CAP FOR D-ARM +32</p> <p>LU ADJUSTABLE LUMBAR PADS +58</p> <p> Adjustable lumbar pads for Mesh Backs</p> <p>Upholstered arm caps must be leather, vinyl, or polyurethane. Height adjustment lock-out comes standard on all Sava chairs.</p>	<p>6. Stool</p> <p>M COUNTER STOOL H BAR STOOL</p> <p>Stool Heights available with Medium Back only.</p>	<p>7. Caster</p> <p>BC BLACK HARD WHEEL BS BLACK SOFT WHEEL +42 CC CHROME TRIM +98 CS CHROME TRIM SOFT WHEEL +123 GA GLIDES W/ABS PADS +98 GF GLIDES W/FELT PADS +98</p>	<p>8. Arm Finish</p> <p>AL POLISHED ALUMINUM CH CHROME +473 BM BLACK MATTE</p> <p>Chrome finish is only available on Fixed Height D-Arms (07).</p> <p>Black Matte finish is only available on the Single Paddle control. Black Matte finish on arms is only available on Fixed Height T-Arm (05) or D-Arm (07).</p>	<p>9. Upholstery</p> <p>See general information section for details on textile program and COM/ COL information.</p>
---	--	---	--	---	---	--	---	---

Sava

MEDIUM BACK: MESH BACK, UPHOLSTERED SEAT, CONFERENCE MECHANISM

TITLE	STYLE	CTRL	ARM	HEIGHT	DIMENSIONS	YDG	SQFT	Textile Upholstery Grades										Leather Upholstery Grades							
								COM	COL	COM	COL	A	B	C	D	E	F	G	H	I	J	K	L	M	W
 <p>Medium Back, Mesh Back, Upholstered Seat, Conference Mechanism</p>	Armless	2	00		19W x 26.5D x 33-38H	0.8	10	1662	1700	1739	1775	1812	1853	1891	1938	1985	2038	2116	2181	2244	1929	1967	2184	2271	2418
				M	19W x 26.5D x 38.5-45.5H	0.8	10	1815	1853	1892	1928	1966	2007	2044	2092	2138	2191	2270	2335	2398	2082	2120	2337	2424	2571
				H	19W x 26.5D x 40.75-50.75H	0.8	10	1815	1853	1892	1928	1966	2007	2044	2092	2138	2191	2270	2335	2398	2082	2120	2337	2424	2571
	Adjustable Arm	2	01		27.5W x 26.5D x 33-38H	0.8	10	2111	2146	2184	2223	2259	2298	2336	2385	2430	2485	2562	2627	2689	2375	2414	2659	2745	2890
				M	27.5W x 26.5D x 38.5-45.5H	0.8	10	2264	2300	2337	2376	2412	2452	2490	2538	2583	2639	2716	2780	2843	2528	2567	2812	2898	3043
				H	27.5W x 26.5D x 40.75-50.75H	0.8	10	2264	2300	2337	2376	2412	2452	2490	2538	2583	2639	2716	2780	2843	2528	2567	2812	2898	3043
	Fixed T-Arm	2	05		27.5W x 26.5D x 33-38H	0.8	10	1895	1933	1970	2007	2044	2084	2123	2170	2217	2270	2348	2413	2476	2161	2198	2430	2519	2662
				M	27.5W x 26.5D x 38.5-45.5H	0.8	10	2049	2086	2123	2160	2198	2238	2276	2324	2370	2423	2501	2566	2629	2314	2351	2583	2672	2815
				H	27.5W x 26.5D x 40.75-50.75H	0.8	10	2049	2086	2123	2160	2198	2238	2276	2324	2370	2423	2501	2566	2629	2314	2351	2583	2672	2815
	Fixed D-Arm	2	07		23.5W x 26.5D x 33-38H	0.8	10	1825	1862	1901	1938	1975	2016	2054	2100	2148	2202	2280	2345	2408	2094	2130	2358	2443	2590
				M	23.5W x 26.5D x 38.5-45.5H	0.8	10	1978	2015	2054	2092	2128	2169	2207	2253	2302	2355	2433	2499	2562	2247	2284	2512	2597	2744
				H	23.5W x 26.5D x 40.75-50.75H	0.8	10	1978	2015	2054	2092	2128	2169	2207	2253	2302	2355	2433	2499	2562	2247	2284	2512	2597	2744

To Order Select Below

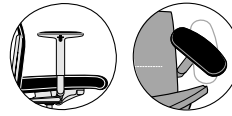
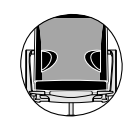





<p>1. Series/Back/Style</p> <p>SV26</p> <p>Sava Chair Medium Back, Mesh Back, Upholstered Seat</p>	<p>2. Control</p> <p>2 CONFERENCE MECHANISM</p> <p>Adjustments Preset Recline Tension Pneumatic Seat Height Tilt Lock</p>	<p>3. Arm</p> <p>00 ARMLESS 01 HEIGHT ADJUSTABLE ARMS 05 FIXED HEIGHT T-ARM 07 FIXED HEIGHT D-ARM</p> <p> Armless  T-Arm  D-Arm</p> <p> Height Adjustable Arms</p> <p>Height adjustable arms come standard with 45° inward rotation and urethane caps.</p>	<p>4. Mesh</p> <p>M1 BLACK M2 BRONZE M3 SILVER WHITE M4 WARM GRAY</p>	<p>5. Options</p> <p>01UC UPHOLSTERED ARM CAP FOR HEIGHT ADJUSTABLE ARM +72</p> <p>05UC UPHOLSTERED ARM CAP FOR T-ARM +72</p> <p>07UC UPHOLSTERED ARM CAP FOR D-ARM +173</p> <p>AC BLACK PLASTIC ARM CAP FOR D-ARM +32</p> <p>LU ADJUSTABLE LUMBAR PADS +58</p> <p>CT CONTRASTING THREAD</p> <p> Adjustable lumbar pads for Mesh Backs</p> <p>Upholstered arm caps must be leather, vinyl, or polyurethane. Height adjustment lock-out comes standard on all Sava chairs.</p>	<p>6. Stool</p> <p>M COUNTER STOOL H BAR STOOL</p> <p>Stool Heights available with Medium Back only.</p>	<p>7. Caster</p> <p>BC BLACK HARD WHEEL BS BLACK SOFT WHEEL +42 CC CHROME TRIM +98 CS CHROME TRIM SOFT WHEEL +123 GA GLIDES W/ABS PADS +98 GF GLIDES W/FELT PADS +98</p>	<p>8. Arm Finish</p> <p>AL POLISHED ALUMINUM CH CHROME +473</p> <p>Chrome finish is only available on Fixed Height D-Arms (07)</p>	<p>9. Upholstery</p> <p>See general information section for details on textile program and COM/ COL information.</p>
--	---	---	--	--	---	--	--	---

Sava

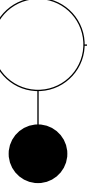
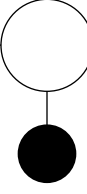
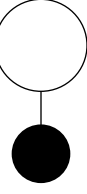
MEDIUM BACK: MESH BACK, UPHOLSTERED SEAT, MULTI-TASK MECHANISM

TITLE	STYLE	CTRL	ARM	HEIGHT	DIMENSIONS	YDG	SQFT	Textile Upholstery Grades										Leather Upholstery Grades								
								COM	COL	COM	COL	A	B	C	D	E	F	G	H	I	J	K	L	M	W	X
 Medium Back, Mesh Back, Upholstered Seat, Multi-Task Mechanism	Armless	SV26	4	00		19W x 26.5D x 33-38H	0.8	10	1782	1819	1856	1894	1931	1971	2010	2056	2103	2158	2235	2300	2363	2048	2085	2311	2397	2542
		SV26	4	00	M	19W x 26.5D x 38.5-45.5H	0.8	10	1935	1972	2010	2048	2084	2124	2163	2209	2256	2311	2388	2453	2516	2201	2239	2464	2550	2695
		SV26	4	00	H	19W x 26.5D x 40.75-50.75H	0.8	10	1935	1972	2010	2048	2084	2124	2163	2209	2256	2311	2388	2453	2516	2201	2239	2464	2550	2695
	Adjustable Arm	SV26	4	01		27.5W x 26.5D x 33-38H	0.8	10	2229	2266	2303	2340	2377	2419	2456	2503	2552	2604	2682	2747	2810	2495	2533	2784	2872	3017
		SV26	4	01	M	27.5W x 26.5D x 38.5-45.5H	0.8	10	2382	2419	2456	2494	2531	2573	2609	2657	2705	2757	2836	2901	2964	2648	2686	2937	3025	3170
		SV26	4	01	H	27.5W x 26.5D x 40.75-50.75H	0.8	10	2382	2419	2456	2494	2531	2573	2609	2657	2705	2757	2836	2901	2964	2648	2686	2937	3025	3170
	Fixed T-Arm	SV26	4	05		27.5W x 26.5D x 33-38H	0.8	10	2013	2051	2087	2127	2163	2203	2241	2290	2335	2391	2468	2534	2597	2281	2318	2558	2642	2790
		SV26	4	05	M	27.5W x 26.5D x 38.5-45.5H	0.8	10	2166	2204	2241	2281	2316	2356	2394	2443	2489	2544	2622	2687	2750	2434	2472	2711	2795	2943
		SV26	4	05	H	27.5W x 26.5D x 40.75-50.75H	0.8	10	2166	2204	2241	2281	2316	2356	2394	2443	2489	2544	2622	2687	2750	2434	2472	2711	2795	2943
	Fixed D-Arm	SV26	4	07		23.5W x 26.5D x 33-38H	0.8	10	1946	1983	2019	2056	2095	2135	2172	2223	2268	2322	2400	2465	2529	2211	2249	2484	2569	2717
		SV26	4	07	M	23.5W x 26.5D x 38.5-45.5H	0.8	10	2099	2137	2172	2209	2248	2288	2326	2376	2421	2475	2553	2618	2682	2365	2402	2638	2723	2871
		SV26	4	07	H	23.5W x 26.5D x 40.75-50.75H	0.8	10	2099	2137	2172	2209	2248	2288	2326	2376	2421	2475	2553	2618	2682	2365	2402	2638	2723	2871

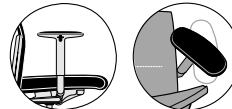
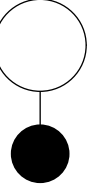
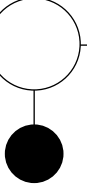
To Order Select Below

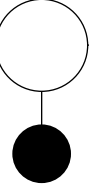
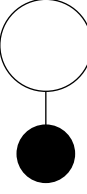
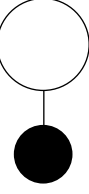
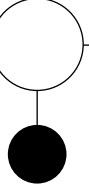







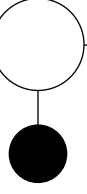
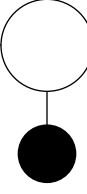
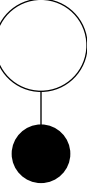

<p>1. Series/Back/Style</p>  <p>SV26</p> <p>Sava Chair Medium Back, Mesh Back, Upholstered Seat</p>	<p>2. Control</p>  <p>Control</p> <p>4 MULTI-TASK MECHANISM</p> <p>Adjustments 4-Position Tilt Tension Pneumatic Seat Height Tilt Lock Seat Depth</p>	<p>3. Arm</p>  <p>Arm</p> <p>00 ARMLESS 01 HEIGHT ADJUSTABLE ARMS 05 FIXED HEIGHT T-ARM 07 FIXED HEIGHT D-ARM</p> <p> Armless  T-Arm  D-Arm</p> <p> Height Adjustable Arms</p> <p>Height adjustable arms come standard with 45° inward rotation and urethane caps.</p>	<p>4. Mesh</p>  <p>Mesh</p> <p>M1 BLACK M2 BRONZE M3 SILVER WHITE M4 WARM GRAY</p>	<p>5. Options</p>  <p>Options</p> <p>01UC UPHOLSTERED ARM CAP FOR HEIGHT ADJUSTABLE ARM +72</p> <p>05UC UPHOLSTERED ARM CAP FOR T-ARM +72</p> <p>07UC UPHOLSTERED ARM CAP FOR D-ARM +173</p> <p>AC BLACK PLASTIC ARM CAP FOR D-ARM +32</p> <p>LU ADJUSTABLE LUMBAR PADS +58</p> <p>CT CONTRASTING THREAD</p> <p> Adjustable lumbar pads for Mesh Backs</p> <p>Upholstered arm caps must be leather, vinyl, or polyurethane. Height adjustment lock-out comes standard on all Sava chairs.</p>	<p>6. Stool</p>  <p>Stool</p> <p>M COUNTER STOOL</p> <p>H BAR STOOL</p> <p>Stool Heights available with Medium Back only.</p>	<p>7. Caster</p>  <p>Caster</p> <p>BC BLACK HARD WHEEL BS BLACK SOFT WHEEL +42 CC CHROME TRIM +98 CS CHROME TRIM SOFT WHEEL +123 GA GLIDES W/ABS PADS +98 GF GLIDES W/FELT PADS +98</p>	<p>8. Arm Finish</p>  <p>Arm Finish</p> <p>AL POLISHED ALUMINUM CH CHROME +473</p> <p>Chrome finish is only available on Fixed Height D-Arms (07)</p>	<p>9. Upholstery</p>  <p>See general information section for details on textile program and COM/ COL information.</p>
---	---	---	---	--	--	---	---	--

Sava

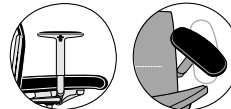
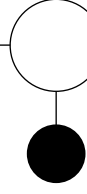
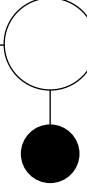
MEDIUM BACK: MESH BACK, UPHOLSTERED SEAT, SINGLE PADDLE MECHANISM

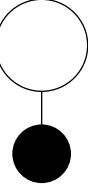
TITLE	STYLE	CTRL	ARM	HEIGHT	DIMENSIONS	YDG	SQFT	Textile Upholstery Grades										Leather Upholstery Grades								
								COM	COL	COM	COL	A	B	C	D	E	F	G	H	I	J	K	L	M	W	X
 Medium Back, Mesh Back, Upholstered Seat, Single Paddle Mechanism	Armless	SV26	1	00		19W x 26.5D x 33-38H	0.8	10	1386	1423	1460	1496	1533	1575	1614	1660	1707	1760	1838	1903	1966	1651	1687	1890	1979	2122
		SV26	1	00	M	19W x 26.5D x 38.5-45.5H	0.8	10	1539	1576	1613	1650	1686	1728	1767	1813	1861	1913	1991	2056	2119	1804	1841	2043	2133	2275
		SV26	1	00	H	19W x 26.5D x 40.75-50.75H	0.8	10	1539	1576	1613	1650	1686	1728	1767	1813	1861	1913	1991	2056	2119	1804	1841	2043	2133	2275
	Adjustable Arm	SV26	1	01		27.5W x 26.5D x 33-38H	0.8	10	1831	1869	1908	1945	1981	2021	2058	2106	2153	2207	2284	2349	2412	2098	2136	2365	2452	2595
		SV26	1	01	M	27.5W x 26.5D x 38.5-45.5H	0.8	10	1985	2022	2061	2098	2135	2175	2211	2260	2306	2360	2437	2502	2565	2251	2289	2518	2605	2748
		SV26	1	01	H	27.5W x 26.5D x 40.75-50.75H	0.8	10	1985	2022	2061	2098	2135	2175	2211	2260	2306	2360	2437	2502	2565	2251	2289	2518	2605	2748
	Fixed T-Arm	SV26	1	05		27.5W x 26.5D x 33-38H	0.8	10	1618	1656	1692	1728	1766	1808	1846	1893	1938	1993	2070	2135	2198	1884	1919	2136	2224	2368
		SV26	1	05	M	27.5W x 26.5D x 38.5-45.5H	0.8	10	1771	1809	1845	1882	1919	1961	1999	2046	2092	2146	2224	2289	2352	2037	2073	2289	2377	2521
		SV26	1	05	H	27.5W x 26.5D x 40.75-50.75H	0.8	10	1771	1809	1845	1882	1919	1961	1999	2046	2092	2146	2224	2289	2352	2037	2073	2289	2377	2521
Fixed D-Arm	SV26	1	07		23.5W x 26.5D x 33-38H	0.8	10	1548	1586	1622	1660	1697	1739	1776	1823	1870	1924	2002	2067	2130	1815	1853	2065	2150	2295	
	SV26	1	07	M	23.5W x 26.5D x 38.5-45.5H	0.8	10	1701	1739	1776	1813	1850	1892	1929	1976	2023	2077	2155	2220	2283	1969	2007	2219	2304	2449	
	SV26	1	07	H	23.5W x 26.5D x 40.75-50.75H	0.8	10	1701	1739	1776	1813	1850	1892	1929	1976	2023	2077	2155	2220	2283	1969	2007	2219	2304	2449	

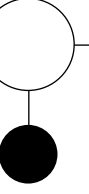
To Order Select Below



<p>1. Series/Back/Style</p>  <p>SV26</p> <p>Sava Chair Medium Back, Mesh Back, Upholstered Seat</p>	<p>2. Control</p>  <p>Control</p> <p>1 SINGLE PADDLE MECHANISM</p> <p>Adjustments Preset Recline Tension Pneumatic Seat Height</p>	<p>3. Arm</p>  <p>Arm</p> <p>00 ARMLESS 01 HEIGHT ADJUSTABLE ARMS 05 FIXED HEIGHT T-ARM 07 FIXED HEIGHT D-ARM</p> <p> Armless  T-Arm  D-Arm</p> <p> Height Adjustable Arms</p> <p>Height adjustable arms come standard with 45° inward rotation and urethane caps.</p>	<p>4. Mesh</p>  <p>Mesh</p> <p>M1 BLACK M2 BRONZE M3 SILVER WHITE M4 WARM GRAY</p>	<p>5. Options</p>  <p>Options</p> <p>01UC UPHOLSTERED ARM CAP FOR HEIGHT ADJUSTABLE ARM +72</p> <p>05UC UPHOLSTERED ARM CAP FOR T-ARM +72</p> <p>07UC UPHOLSTERED ARM CAP FOR D-ARM +173</p> <p>AC BLACK PLASTIC ARM CAP FOR D-ARM +32</p> <p>LU ADJUSTABLE LUMBAR PADS +58</p> <p>CT CONTRASTING THREAD</p> <p> Adjustable lumbar pads for Mesh Backs</p> <p>Upholstered arm caps must be leather, vinyl, or polyurethane. Height adjustment lock-out comes standard on all Sava chairs.</p>	<p>6. Stool</p>  <p>Stool</p> <p>M COUNTER STOOL H BAR STOOL</p> <p>Stool Heights available with Medium Back only.</p>	<p>7. Caster</p>  <p>Caster</p> <p>BC BLACK HARD WHEEL BS BLACK SOFT WHEEL +42 CC CHROME TRIM +98 CS CHROME TRIM SOFT WHEEL +123 GA GLIDES W/ABS PADS +98 GF GLIDES W/FELT PADS +98</p>	<p>8. Arm Finish</p>  <p>Arm Finish</p> <p>AL POLISHED ALUMINUM CH CHROME +473 BM BLACK MATTE</p> <p>Chrome finish is only available on Fixed Height D-Arms (07).</p> <p>Black Matte finish is only available on the Single Paddle control. Black Matte finish on arms is only available on Fixed Height T-Arm (05) or D-Arm (07).</p>	<p>9. Upholstery</p>  <p>See general information section for details on textile program and COM/ COL information.</p>
---	---	--	--	---	--	--	---	---

Sava

MEDIUM BACK: STANDARD UPHOLSTERY BACK, UPHOLSTERED SEAT, CONFERENCE MECHANISM

TITLE	STYLE	CTRL	ARM	HEIGHT	DIMENSIONS	YDG	SQFT	Textile Upholstery Grades										Leather Upholstery Grades							
								COM	COL	COM	COL	A	B	C	D	E	F	G	H	I	J	K	L	M	W
 <p>Medium Back, Standard Upholstery Back, Upholstered Seat, Conference Mechanism</p>	Armless	2	00		19W x 26.5D x 33-38H	1.5	24	1870	1943	2013	2083	2156	2231	2307	2397	2490	2586	2738	2862	2983	2567	2657	3068	3360	3631
				M	19W x 26.5D x 38.5-45.5H	1.5	24	2023	2096	2166	2237	2309	2385	2460	2550	2643	2739	2891	3015	3136	2721	2810	3221	3513	3784
				H	19W x 26.5D x 40.75-50.75H	1.5	24	2023	2096	2166	2237	2309	2385	2460	2550	2643	2739	2891	3015	3136	2721	2810	3221	3513	3784
	Adjustable Arm	2	01		27.5W x 26.5D x 33-38H	1.5	24	2324	2397	2469	2539	2611	2687	2764	2852	2943	3043	3194	3319	3439	3022	3113	3549	3842	4113
				M	27.5W x 26.5D x 38.5-45.5H	1.5	24	2477	2550	2622	2692	2765	2840	2917	3005	3096	3196	3347	3472	3592	3175	3267	3702	3995	4266
				H	27.5W x 26.5D x 40.75-50.75H	1.5	24	2477	2550	2622	2692	2765	2840	2917	3005	3096	3196	3347	3472	3592	3175	3267	3702	3995	4266
	Fixed T-Arm	2	05		27.5W x 26.5D x 33-38H	1.5	24	2106	2179	2249	2321	2393	2469	2542	2633	2724	2822	2973	3097	3218	2804	2893	3318	3610	3882
				M	27.5W x 26.5D x 38.5-45.5H	1.5	24	2260	2332	2402	2474	2546	2622	2695	2787	2877	2976	3127	3251	3371	2957	3046	3471	3763	4035
				H	27.5W x 26.5D x 40.75-50.75H	1.5	24	2260	2332	2402	2474	2546	2622	2695	2787	2877	2976	3127	3251	3371	2957	3046	3471	3763	4035
	Fixed D-Arm	2	07		23.5W x 26.5D x 33-38H	1.5	24	2037	2109	2180	2249	2323	2398	2472	2565	2654	2754	2904	3029	3149	2733	2822	3246	3534	3808
				M	23.5W x 26.5D x 38.5-45.5H	1.5	24	2190	2263	2333	2402	2476	2552	2625	2718	2808	2907	3058	3182	3303	2886	2976	3399	3688	3962
				H	23.5W x 26.5D x 40.75-50.75H	1.5	24	2190	2263	2333	2402	2476	2552	2625	2718	2808	2907	3058	3182	3303	2886	2976	3399	3688	3962

To Order Select Below

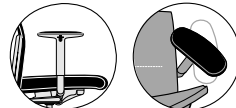



<p>1. Series/Back/Style</p> <p>SV46</p> <p>Sava Chair Medium Back, Standard Upholstery Back, Upholstered Seat</p>	<p>2. Control</p> <p>2 CONFERENCE MECHANISM</p> <p>Adjustments Preset Recline Tension Pneumatic Seat Height Tilt Lock</p>	<p>3. Arm</p> <p>00 ARMLESS 01 HEIGHT ADJUSTABLE ARMS 05 FIXED HEIGHT T-ARM 07 FIXED HEIGHT D-ARM</p> <p> Armless  T-Arm  D-Arm</p> <p> Height Adjustable Arms</p> <p>Height adjustable arms come standard with 45° inward rotation and urethane caps.</p>	<p>4. Options</p> <p>01UC UPHOLSTERED ARM CAP FOR HEIGHT ADJUSTABLE ARM +72</p> <p>05UC UPHOLSTERED ARM CAP FOR T-ARM +72</p> <p>07UC UPHOLSTERED ARM CAP FOR D-ARM +173</p> <p>AC BLACK PLASTIC ARM CAP FOR D-ARM +32</p> <p>CT CONTRASTING THREAD</p> <p>Upholstered arm caps must be leather, vinyl, or polyurethane. Height adjustment lock-out comes standard on all Sava chairs.</p>	<p>5. Stool</p> <p>M COUNTER STOOL</p> <p>H BAR STOOL</p> <p>Stool Heights available with Medium Back only.</p>	<p>7. Caster</p> <p>BC BLACK HARD WHEEL BS BLACK SOFT WHEEL +42 CC CHROME TRIM +98 CS CHROME TRIM SOFT WHEEL +123 GA GLIDES W/ABS PADS +98 GF GLIDES W/FELT PADS +98</p>	<p>8. Arm Finish</p> <p>AL POLISHED ALUMINUM CH CHROME +473</p> <p>Chrome finish is only available on Fixed Height D-Arms (07)</p>	<p>8. Upholstery</p> <p>See general information section for details on textile program and COM/ COL information.</p>
---	---	---	---	--	--	--	---

Sava

MEDIUM BACK: STANDARD UPHOLSTERY BACK, UPHOLSTERED SEAT, MULTI-TASK MECHANISM

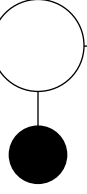
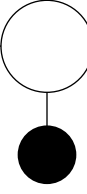
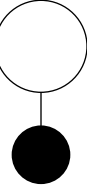
TITLE	STYLE	CTRL	ARM	HEIGHT	DIMENSIONS	YDG	SQFT	Textile Upholstery Grades										Leather Upholstery Grades							
								COM	COL	COM	COL	A	B	C	D	E	F	G	H	I	J	K	L	M	W
 <p>Medium Back, Standard Upholstery Back, Upholstered Seat, Multi-Task Mechanism</p>	Armless	4	00		19W x 26.5D x 33-38H	1.5	24	1990	2063	2135	2205	2277	2354	2428	2519	2608	2707	2859	2983	3103	2689	2778	3198	3488	3761
				M	19W x 26.5D x 38.5-45.5H	1.5	24	2143	2217	2288	2358	2431	2507	2581	2672	2762	2860	3012	3136	3256	2842	2932	3352	3641	3914
				H	19W x 26.5D x 40.75-50.75H	1.5	24	2143	2217	2288	2358	2431	2507	2581	2672	2762	2860	3012	3136	3256	2842	2932	3352	3641	3914
	Adjustable Arm	4	01		27.5W x 26.5D x 33-38H	1.5	24	2444	2519	2590	2660	2732	2809	2882	2974	3064	3164	3315	3439	3560	3145	3232	3679	3968	4242
				M	27.5W x 26.5D x 38.5-45.5H	1.5	24	2598	2672	2744	2813	2885	2962	3036	3127	3217	3317	3468	3592	3713	3298	3385	3833	4121	4395
				H	27.5W x 26.5D x 40.75-50.75H	1.5	24	2598	2672	2744	2813	2885	2962	3036	3127	3217	3317	3468	3592	3713	3298	3385	3833	4121	4395
	Fixed T-Arm	4	05		27.5W x 26.5D x 33-38H	1.5	24	2227	2298	2370	2441	2515	2590	2664	2754	2846	2944	3096	3220	3341	2925	3016	3446	3738	4012
				M	27.5W x 26.5D x 38.5-45.5H	1.5	24	2380	2452	2523	2595	2668	2744	2817	2907	2999	3098	3249	3374	3494	3079	3169	3599	3891	4165
				H	27.5W x 26.5D x 40.75-50.75H	1.5	24	2380	2452	2523	2595	2668	2744	2817	2907	2999	3098	3249	3374	3494	3079	3169	3599	3891	4165
	Fixed D-Arm	4	07		23.5W x 26.5D x 33-38H	1.5	24	2158	2230	2302	2372	2443	2520	2594	2685	2776	2876	3026	3151	3271	2855	2946	3375	3663	3938
				M	23.5W x 26.5D x 38.5-45.5H	1.5	24	2311	2384	2455	2525	2597	2673	2747	2838	2930	3029	3179	3304	3424	3008	3100	3528	3817	4091
				H	23.5W x 26.5D x 40.75-50.75H	1.5	24	2311	2384	2455	2525	2597	2673	2747	2838	2930	3029	3179	3304	3424	3008	3100	3528	3817	4091

To Order Select Below

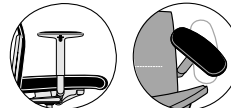
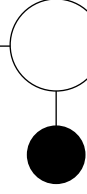
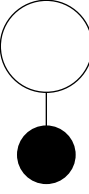
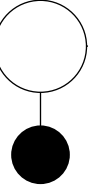
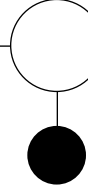
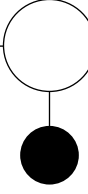

<p>1. Series/Back/Style</p>  <p>SV46</p> <p>Sava Chair Medium Back, Standard Upholstery Back, Upholstered Seat</p>	<p>2. Control</p>  <p>Control</p> <p>4 MULTI-TASK MECHANISM</p> <p>Adjustments 4-Position Tilt Tension Pneumatic Seat Height Tilt Lock Seat Depth</p>	<p>3. Arm</p>  <p>Arm</p> <p>00 ARMLESS 01 HEIGHT ADJUSTABLE ARMS 05 FIXED HEIGHT T-ARM 07 FIXED HEIGHT D-ARM</p> <p> Armless  T-Arm  D-Arm</p> <p> Height Adjustable Arms</p> <p>Height adjustable arms come standard with 45° inward rotation and urethane caps.</p>	<p>4. Options</p>  <p>Options</p> <p>01UC UPHOLSTERED ARM CAP FOR HEIGHT ADJUSTABLE ARM +72</p> <p>05UC UPHOLSTERED ARM CAP FOR T-ARM +72</p> <p>07UC UPHOLSTERED ARM CAP FOR D-ARM +173</p> <p>AC BLACK PLASTIC ARM CAP FOR D-ARM +32</p> <p>CT CONTRASTING THREAD</p> <p>Upholstered arm caps must be leather, vinyl, or polyurethane. Height adjustment lock-out comes standard on all Sava chairs.</p>	<p>5. Stool</p>  <p>Stool</p> <p>M COUNTER STOOL H BAR STOOL</p> <p>Stool Heights available with Medium Back only.</p>	<p>7. Caster</p>  <p>Caster</p> <p>BC BLACK HARD WHEEL BS BLACK SOFT WHEEL +42 CC CHROME TRIM +98 CS CHROME TRIM SOFT WHEEL +123 GA GLIDES W/ABS PADS +98 GF GLIDES W/FELT PADS +98</p>	<p>8. Arm Finish</p>  <p>Arm Finish</p> <p>AL POLISHED ALUMINUM CH CHROME +473</p> <p>Chrome finish is only available on Fixed Height D-Arms (07)</p>	<p>8. Upholstery</p>  <p>See general information section for details on textile program and COM/ COL information.</p>
--	---	---	---	---	---	---	--

Sava

MEDIUM BACK: STANDARD UPHOLSTERY BACK, UPHOLSTERED SEAT, SINGLE PADDLE MECHANISM

TITLE	STYLE	CTRL	ARM	HEIGHT	DIMENSIONS	YDG	SQFT	Textile Upholstery Grades										Leather Upholstery Grades							
								COM	COL	COM	COL	A	B	C	D	E	F	G	H	I	J	K	L	M	W
 Medium Back, Standard Upholstery Back, Upholstered Seat, Single Paddle Mechanism	Armless	1	00		19W x 26.5D x 33-38H	1.5	24	1586	1658	1729	1801	1873	1948	2022	2113	2205	2305	2455	2580	2700	2284	2373	2768	3060	3332
				M	19W x 26.5D x 38.5-45.5H	1.5	24	1739	1811	1883	1954	2027	2101	2176	2266	2358	2458	2608	2733	2853	2437	2526	2921	3213	3485
				H	19W x 26.5D x 40.75-50.75H	1.5	24	1739	1811	1883	1954	2027	2101	2176	2266	2358	2458	2608	2733	2853	2437	2526	2921	3213	3485
	Adjustable Arm	1	01		27.5W x 26.5D x 33-38H	1.5	24	2041	2113	2184	2255	2329	2405	2479	2568	2660	2758	2910	3034	3155	2739	2829	3250	3543	3814
				M	27.5W x 26.5D x 38.5-45.5H	1.5	24	2195	2266	2337	2409	2482	2558	2632	2722	2813	2912	3063	3188	3308	2893	2982	3403	3696	3967
				H	27.5W x 26.5D x 40.75-50.75H	1.5	24	2195	2266	2337	2409	2482	2558	2632	2722	2813	2912	3063	3188	3308	2893	2982	3403	3696	3967
	Fixed T-Arm	1	05		27.5W x 26.5D x 33-38H	1.5	24	1823	1895	1968	2037	2109	2184	2260	2350	2441	2540	2691	2815	2935	2521	2609	3019	3309	3582
				M	27.5W x 26.5D x 38.5-45.5H	1.5	24	1976	2049	2121	2190	2263	2337	2413	2503	2595	2693	2844	2968	3088	2674	2763	3172	3462	3735
				H	27.5W x 26.5D x 40.75-50.75H	1.5	24	1976	2049	2121	2190	2263	2337	2413	2503	2595	2693	2844	2968	3088	2674	2763	3172	3462	3735
	Fixed D-Arm	1	07		23.5W x 26.5D x 33-38H	1.5	24	1755	1826	1896	1968	2040	2115	2191	2282	2370	2471	2621	2745	2866	2452	2540	2946	3235	3509
				M	23.5W x 26.5D x 38.5-45.5H	1.5	24	1908	1979	2050	2121	2193	2268	2345	2435	2523	2624	2774	2899	3019	2605	2693	3100	3388	3662
				H	23.5W x 26.5D x 40.75-50.75H	1.5	24	1908	1979	2050	2121	2193	2268	2345	2435	2523	2624	2774	2899	3019	2605	2693	3100	3388	3662

To Order Select Below

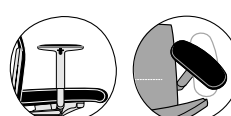





<p>1. Series/Back/Style</p> <p>SV46</p> <p>Sava Chair Medium Back, Standard Upholstery Back, Upholstered Seat</p>	<p>2. Control</p> <p>1 SINGLE PADDLE MECHANISM</p> <p>Adjustments Preset Recline Tension Pneumatic Seat Height</p>	<p>3. Arm</p> <p>00 ARMLESS 01 HEIGHT ADJUSTABLE ARMS 05 FIXED HEIGHT T-ARM 07 FIXED HEIGHT D-ARM</p> <p>  Armless  T-Arm  D-Arm </p> <p>  Height Adjustable Arms </p> <p>Height adjustable arms come standard with 45° inward rotation and urethane caps.</p>	<p>4. Options</p> <p>01UC UPHOLSTERED ARM CAP FOR HEIGHT ADJUSTABLE ARM +72</p> <p>05UC UPHOLSTERED ARM CAP FOR T-ARM +72</p> <p>07UC UPHOLSTERED ARM CAP FOR D-ARM +173</p> <p>AC BLACK PLASTIC ARM CAP FOR D-ARM +32</p> <p>CT CONTRASTING THREAD</p> <p>Upholstered arm caps must be leather, vinyl, or polyurethane. Height adjustment lock-out comes standard on all Sava chairs.</p>	<p>5. Stool</p> <p>M COUNTER STOOL</p> <p>H BAR STOOL</p> <p>Stool Heights available with Medium Back only.</p>	<p>7. Caster</p> <p>BC BLACK HARD WHEEL BS BLACK SOFT WHEEL +42 CC CHROME TRIM +98 CS CHROME TRIM SOFT WHEEL +123 GA GLIDES W/ABS PADS +98 GF GLIDES W/FELT PADS +98</p>	<p>7. Arm Finish</p> <p>AL POLISHED ALUMINUM CH CHROME +473 BM BLACK MATTE</p> <p>Chrome finish is only available on Fixed Height D-Arms (07)</p> <p>Black Matte finish is only available on the Single Paddle control. Black Matte finish on arms is only available on Fixed Height T-Arm (05) or D-Arm (07).</p>	<p>8. Upholstery</p> <p>See general information section for details on textile program and COM/ COL information.</p>
---	--	---	---	--	--	--	---

Sava

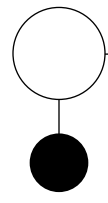
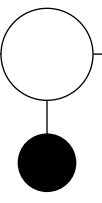
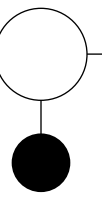
MEDIUM BACK: EURO UPHOLSTERY BACK, EURO UPHOLSTERY SEAT, CONFERENCE MECHANISM

TITLE	STYLE	CTRL	ARM	HEIGHT	DIMENSIONS	YDG	SQFT	Textile Upholstery Grades										Leather Upholstery Grades								
								COM	COL	COM	COL	A	B	C	D	E	F	G	H	I	J	K	L	M	W	X
	Armless	SV56	2	00		19W x 26.5D x 33-38H	1.5	24	1870	1943	2013	2083	2156	2231	2307	2397	2490	2586	2738	2862	2983	2567	2657	3068	3360	3631
		SV56	2	00	M	19W x 26.5D x 38.5-45.5H	1.5	24	2023	2096	2166	2237	2309	2385	2460	2550	2643	2739	2891	3015	3136	2721	2810	3221	3513	3784
		SV56	2	00	H	19W x 26.5D x 40.75-50.75H	1.5	24	2023	2096	2166	2237	2309	2385	2460	2550	2643	2739	2891	3015	3136	2721	2810	3221	3513	3784
	Adjustable Arm	SV56	2	01		27.5W x 26.5D x 33-38H	1.5	24	2324	2397	2469	2539	2611	2687	2764	2852	2943	3043	3194	3319	3439	3022	3113	3549	3842	4113
		SV56	2	01	M	27.5W x 26.5D x 38.5-45.5H	1.5	24	2477	2550	2622	2692	2765	2840	2917	3005	3096	3196	3347	3472	3592	3175	3267	3702	3995	4266
		SV56	2	01	H	27.5W x 26.5D x 40.75-50.75H	1.5	24	2477	2550	2622	2692	2765	2840	2917	3005	3096	3196	3347	3472	3592	3175	3267	3702	3995	4266
	Fixed T-Arm	SV56	2	05		27.5W x 26.5D x 33-38H	1.5	24	2106	2179	2249	2321	2393	2469	2542	2633	2724	2822	2973	3097	3218	2804	2893	3318	3610	3882
		SV56	2	05	M	27.5W x 26.5D x 38.5-45.5H	1.5	24	2260	2332	2402	2474	2546	2622	2695	2787	2877	2976	3127	3251	3371	2957	3046	3471	3763	4035
		SV56	2	05	H	27.5W x 26.5D x 40.75-50.75H	1.5	24	2260	2332	2402	2474	2546	2622	2695	2787	2877	2976	3127	3251	3371	2957	3046	3471	3763	4035
	Fixed D-Arm	SV56	2	07		23.5W x 26.5D x 33-38H	1.5	24	2037	2109	2180	2249	2323	2398	2472	2565	2654	2754	2904	3029	3149	2733	2822	3246	3534	3808
		SV56	2	07	M	23.5W x 26.5D x 38.5-45.5H	1.5	24	2190	2263	2333	2402	2476	2552	2625	2718	2808	2907	3058	3182	3303	2886	2976	3399	3688	3962
		SV56	2	07	H	23.5W x 26.5D x 40.75-50.75H	1.5	24	2190	2263	2333	2402	2476	2552	2625	2718	2808	2907	3058	3182	3303	2886	2976	3399	3688	3962

To Order Select Below

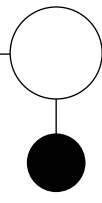
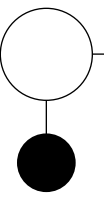
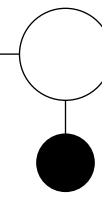
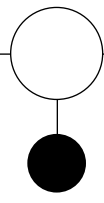
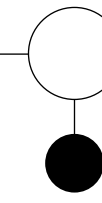



<p>1. Series/Back/Style</p>  <p>SV56</p> <p>Sava Chair Medium Back, Euro Upholstery Back, Euro Upholstered Seat</p>	<p>2. Control</p>  <p>2 CONFERENCE MECHANISM</p> <p>Adjustments Preset Recline Tension Pneumatic Seat Height Tilt Lock</p>	<p>3. Arm</p>  <p>00 ARMLESS 01 HEIGHT ADJUSTABLE ARMS 05 FIXED HEIGHT T-ARM 07 FIXED HEIGHT D-ARM</p> <div style="display: flex; justify-content: space-around;">  Armless  T-Arm  D-Arm </div> <div style="display: flex; justify-content: space-around; margin-top: 10px;">   </div> <p>Height adjustable arms come standard with 45° inward rotation and urethane caps.</p>	<p>4. Options</p>  <p>01UC UPHOLSTERED ARM CAP FOR HEIGHT ADJUSTABLE ARM +72</p> <p>05UC UPHOLSTERED ARM CAP FOR T-ARM +72</p> <p>07UC UPHOLSTERED ARM CAP FOR D-ARM +173</p> <p>AC BLACK PLASTIC ARM CAP FOR D-ARM +32</p> <p>CT CONTRASTING THREAD</p> <p>Upholstered arm caps must be leather, vinyl, or polyurethane. Height adjustment lock-out comes standard on all Sava chairs.</p>	<p>5. Stool</p>  <p>M COUNTER STOOL</p> <p>H BAR STOOL</p> <p>Stool Heights available with Medium Back only.</p>	<p>7. Caster</p>  <p>BC BLACK HARD WHEEL BS BLACK SOFT WHEEL +42 CC CHROME TRIM +98 CS CHROME TRIM SOFT WHEEL +123 GA GLIDES W/ABS PADS +98 GF GLIDES W/FELT PADS +98</p>	<p>8. Arm Finish</p>  <p>AL POLISHED ALUMINUM CH CHROME +473</p> <p>Chrome finish is only available on Fixed Height D-Arms (07)</p>	<p>8. Upholstery</p>  <p>See general information section for details on textile program and COM/ COL information.</p>
---	---	--	---	--	--	--	---

Sava

MEDIUM BACK: EURO UPHOLSTERY BACK, EURO UPHOLSTERY SEAT, MULTI-TASK MECHANISM

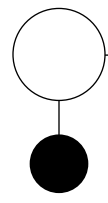
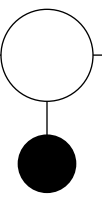
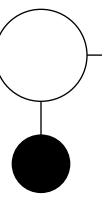
TITLE	STYLE	CTRL	ARM	HEIGHT	DIMENSIONS	YDG	SQFT	Textile Upholstery Grades										Leather Upholstery Grades								
								COM	COL	COM	COL	A	B	C	D	E	F	G	H	I	J	K	L	M	W	X
 Medium Back, Euro Upholstery Back, Euro Upholstery Seat, Multi-Task Mechanism	Armless	SV56	4	00		19W x 26.5D x 33-38H	1.5	24	1990	2063	2135	2205	2277	2354	2428	2519	2608	2707	2859	2983	3103	2689	2778	3198	3488	3761
		SV56	4	00	M	19W x 26.5D x 38.5-45.5H	1.5	24	2143	2217	2288	2358	2431	2507	2581	2672	2762	2860	3012	3136	3256	2842	2932	3352	3641	3914
		SV56	4	00	H	19W x 26.5D x 40.75-50.75H	1.5	24	2143	2217	2288	2358	2431	2507	2581	2672	2762	2860	3012	3136	3256	2842	2932	3352	3641	3914
	Adjustable Arm	SV56	4	01		27.5W x 26.5D x 33-38H	1.5	24	2444	2519	2590	2660	2732	2809	2882	2974	3064	3164	3315	3439	3560	3145	3232	3679	3968	4242
		SV56	4	01	M	27.5W x 26.5D x 38.5-45.5H	1.5	24	2598	2672	2744	2813	2885	2962	3036	3127	3217	3317	3468	3592	3713	3298	3385	3833	4121	4395
		SV56	4	01	H	27.5W x 26.5D x 40.75-50.75H	1.5	24	2598	2672	2744	2813	2885	2962	3036	3127	3217	3317	3468	3592	3713	3298	3385	3833	4121	4395
	Fixed T-Arm	SV56	4	05		27.5W x 26.5D x 33-38H	1.5	24	2227	2298	2370	2441	2515	2590	2664	2754	2846	2944	3096	3220	3341	2925	3016	3446	3738	4012
		SV56	4	05	M	27.5W x 26.5D x 38.5-45.5H	1.5	24	2380	2452	2523	2595	2668	2744	2817	2907	2999	3098	3249	3374	3494	3079	3169	3599	3891	4165
		SV56	4	05	H	27.5W x 26.5D x 40.75-50.75H	1.5	24	2380	2452	2523	2595	2668	2744	2817	2907	2999	3098	3249	3374	3494	3079	3169	3599	3891	4165
	Fixed D-Arm	SV56	4	07		23.5W x 26.5D x 33-38H	1.5	24	2158	2230	2302	2372	2443	2520	2594	2685	2776	2876	3026	3151	3271	2855	2946	3375	3663	3938
		SV56	4	07	M	23.5W x 26.5D x 38.5-45.5H	1.5	24	2311	2384	2455	2525	2597	2673	2747	2838	2930	3029	3179	3304	3424	3008	3100	3528	3817	4091
		SV56	4	07	H	23.5W x 26.5D x 40.75-50.75H	1.5	24	2311	2384	2455	2525	2597	2673	2747	2838	2930	3029	3179	3304	3424	3008	3100	3528	3817	4091

To Order Select Below

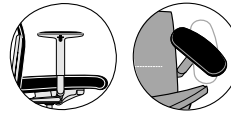
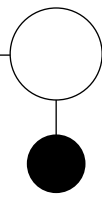
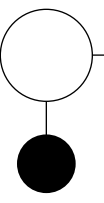
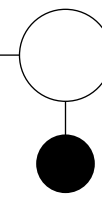
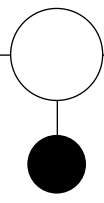
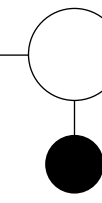



<p>1. Series/Back/Style</p>  <p>SV56</p> <p>Sava Chair, Medium Back, Euro Upholstery Back, Euro Upholstery Seat</p>	<p>2. Control</p>  <p>Control</p> <p>4 MULTI-TASK MECHANISM</p> <p>Adjustments 4-Position Tilt Tension Pneumatic Seat Height Tilt Lock Seat Depth</p>	<p>3. Arm</p>  <p>Arm</p> <p>00 ARMLESS 01 HEIGHT ADJUSTABLE ARMS 05 FIXED HEIGHT T-ARM 07 FIXED HEIGHT D-ARM</p> <p> Armless  T-Arm  D-Arm</p> <p> Height Adjustable Arms</p> <p>Height adjustable arms come standard with 45° inward rotation and urethane caps.</p>	<p>4. Options</p>  <p>Options</p> <p>01UC UPHOLSTERED ARM CAP FOR HEIGHT ADJUSTABLE ARM +72</p> <p>05UC UPHOLSTERED ARM CAP FOR T-ARM +72</p> <p>07UC UPHOLSTERED ARM CAP FOR D-ARM +173</p> <p>AC BLACK PLASTIC ARM CAP FOR D-ARM +32</p> <p>CT CONTRASTING THREAD</p> <p>Upholstered arm caps must be leather, vinyl, or polyurethane. Height adjustment lock-out comes standard on all Sava chairs.</p>	<p>5. Stool</p>  <p>Stool</p> <p>M COUNTER STOOL H BAR STOOL</p> <p>Stool Heights available with Medium Back only.</p>	<p>7. Caster</p>  <p>Caster</p> <p>BC BLACK HARD WHEEL BS BLACK SOFT WHEEL +42 CC CHROME TRIM +98 CS CHROME TRIM SOFT WHEEL +123 GA GLIDES W/ABS PADS +98 GF GLIDES W/FELT PADS +98</p>	<p>8. Arm Finish</p>  <p>Arm Finish</p> <p>AL POLISHED ALUMINUM CH CHROME +473</p> <p>Chrome finish is only available on Fixed Height D-Arms (07)</p>	<p>8. Upholstery</p>  <p>See general information section for details on textile program and COM/ COL information.</p>
---	---	---	---	---	---	---	--

Sava

MEDIUM BACK: EURO UPHOLSTERY BACK, EURO UPHOLSTERY SEAT, SINGLE PADDLE MECHANISM

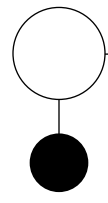
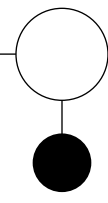
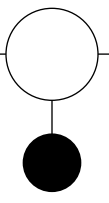
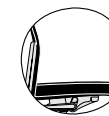
TITLE	STYLE	CTRL	ARM	HEIGHT	DIMENSIONS	YDG	SQFT	Textile Upholstery Grades										Leather Upholstery Grades							
								COM	COL	COM	COL	A	B	C	D	E	F	G	H	I	J	K	L	M	W
 Medium Back, Euro Upholstery Back, Euro Upholstery Seat, Single Paddle Mechanism	Armless	1	00		19W x 26.5D x 33-38H	1.5	24	1586	1658	1729	1801	1873	1948	2022	2113	2205	2305	2455	2580	2700	2284	2373	2768	3060	3332
				M	19W x 26.5D x 38.5-45.5H	1.5	24	1739	1811	1883	1954	2027	2101	2176	2266	2358	2458	2608	2733	2853	2437	2526	2921	3213	3485
				H	19W x 26.5D x 40.75-50.75H	1.5	24	1739	1811	1883	1954	2027	2101	2176	2266	2358	2458	2608	2733	2853	2437	2526	2921	3213	3485
	Adjustable Arm	1	01		27.5W x 26.5D x 33-38H	1.5	24	2041	2113	2184	2255	2329	2405	2479	2568	2660	2758	2910	3034	3155	2739	2829	3250	3543	3814
				M	27.5W x 26.5D x 38.5-45.5H	1.5	24	2195	2266	2337	2409	2482	2558	2632	2722	2813	2912	3063	3188	3308	2893	2982	3403	3696	3967
				H	27.5W x 26.5D x 40.75-50.75H	1.5	24	2195	2266	2337	2409	2482	2558	2632	2722	2813	2912	3063	3188	3308	2893	2982	3403	3696	3967
	Fixed T-Arm	1	05		27.5W x 26.5D x 33-38H	1.5	24	1823	1895	1968	2037	2109	2184	2260	2350	2441	2540	2691	2815	2935	2521	2609	3019	3309	3582
				M	27.5W x 26.5D x 38.5-45.5H	1.5	24	1976	2049	2121	2190	2263	2337	2413	2503	2595	2693	2844	2968	3088	2674	2763	3172	3462	3735
				H	27.5W x 26.5D x 40.75-50.75H	1.5	24	1976	2049	2121	2190	2263	2337	2413	2503	2595	2693	2844	2968	3088	2674	2763	3172	3462	3735
	Fixed D-Arm	1	07		23.5W x 26.5D x 33-38H	1.5	24	1755	1826	1896	1968	2040	2115	2191	2282	2370	2471	2621	2745	2866	2452	2540	2946	3235	3509
				M	23.5W x 26.5D x 38.5-45.5H	1.5	24	1908	1979	2050	2121	2193	2268	2345	2435	2523	2624	2774	2899	3019	2605	2693	3100	3388	3662
				H	23.5W x 26.5D x 40.75-50.75H	1.5	24	1908	1979	2050	2121	2193	2268	2345	2435	2523	2624	2774	2899	3019	2605	2693	3100	3388	3662

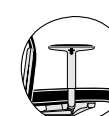
To Order Select Below

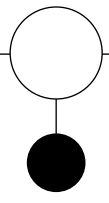
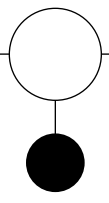
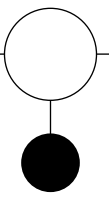
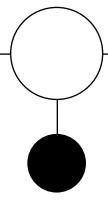
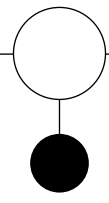





<p>1. Series/Back/Style</p>  <p>SV56</p> <p>Sava Chair Medium Back, Euro Upholstery Back, Euro Upholstery Seat</p>	<p>2. Control</p>  <p>1 SINGLE PADDLE MECHANISM</p> <p>Adjustments Preset Recline Tension Pneumatic Seat Height</p>	<p>3. Arm</p>  <p>00 ARMLESS 01 HEIGHT ADJUSTABLE ARMS 05 FIXED HEIGHT T-ARM 07 FIXED HEIGHT D-ARM</p> <div style="display: flex; justify-content: space-around; align-items: center;">  Armless  T-Arm  D-Arm </div> <div style="display: flex; justify-content: space-around; align-items: center; margin-top: 10px;">   Height Adjustable Arms </div> <p>Height adjustable arms come standard with 45° inward rotation and urethane caps.</p>	<p>4. Options</p>  <p>01UC UPHOLSTERED ARM CAP FOR HEIGHT ADJUSTABLE ARM +72</p> <p>05UC UPHOLSTERED ARM CAP FOR T-ARM +72</p> <p>07UC UPHOLSTERED ARM CAP FOR D-ARM +173</p> <p>AC BLACK PLASTIC ARM CAP FOR D-ARM +32</p> <p>CT CONTRASTING THREAD</p> <p>Upholstered arm caps must be leather, vinyl, or polyurethane. Height adjustment lock-out comes standard on all Sava chairs.</p>	<p>5. Stool</p>  <p>M COUNTER STOOL</p> <p>H BAR STOOL</p> <p>Stool Heights available with Medium Back only.</p>	<p>7. Caster</p>  <p>BC BLACK HARD WHEEL BS BLACK SOFT WHEEL +42 CC CHROME TRIM +98 CS CHROME TRIM SOFT WHEEL +123 GA GLIDES W/ABS PADS +98 GF GLIDES W/FELT PADS +98</p>	<p>7. Arm Finish</p>  <p>AL POLISHED ALUMINUM CH CHROME +473 BM BLACK MATTE</p> <p>Chrome finish is only available on Fixed Height D-Arms (07)</p> <p>Black Matte finish is only available on the Single Paddle control. Black Matte finish on arms is only available on Fixed Height T-Arm (05) or D-Arm (07).</p>	<p>8. Upholstery</p>  <p>See general information section for details on textile program and COM/ COL information.</p>
--	--	---	---	--	--	--	---

Sava

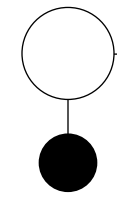
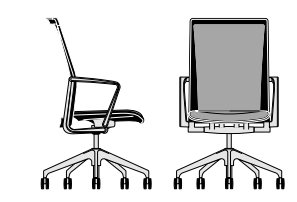
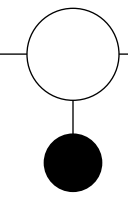
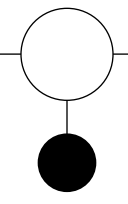
HIGH BACK: MESH BACK, MESH SEAT

TITLE	STYLE	CTRL	ARM	HEIGHT	DIMENSIONS	YDG	SQFT	Textile Upholstery Grades										Leather Upholstery Grades							
								COM	COL	COM	COL	A	B	C	D	E	F	G	H	I	J	K	L	M	W
High Back, Mesh Back, Mesh Seat, Conference Mechanism	Armless	SV18	2	00		19W x 26.5D x 37.5-42.5H	0	0	1884																
	Adjustable Arm	SV18	2	01		27.5W x 26.5D x 37.5-42.5H	0	0	2330																
	Fixed T-Arm	SV18	2	05		27.5W x 26.5D x 37.5-42.5H	0	0	2116																
	Fixed D-Arm	SV18	2	07		23.5W x 26.5D x 37.5-42.5H	0	0	2046																
High Back, Mesh Back, Mesh Seat, Single Paddle Mechanism	Armless	SV18	1	00		19W x 26.5D x 37.5-42.5H	0	0	1607																
	Adjustable Arm	SV18	1	01		27.5W x 26.5D x 37.5-42.5H	0	0	2053																
	Fixed T-Arm	SV18	1	05		27.5W x 26.5D x 37.5-42.5H	0	0	1838																
	Fixed D-Arm	SV18	1	07		23.5W x 26.5D x 37.5-42.5H	0	0	1769																

To Order Select Below

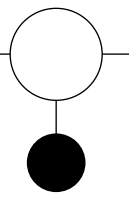
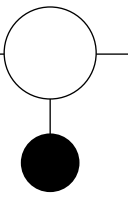
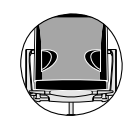
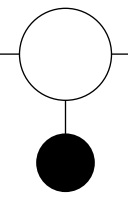
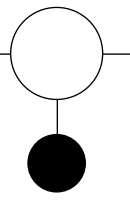
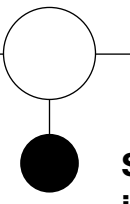



<p>1. Series/Back/Style</p>  <p>SV18</p> <p>Sava Chair High Back, Mesh Back, Mesh Seat</p> 	<p>2. Control</p>  <p>Control</p> <table border="0"> <tr> <td>2</td> <td>CONFERENCE MECHANISM</td> </tr> <tr> <td>1</td> <td>SINGLE PADDLE MECHANISM</td> </tr> </table> <p>Conference Adjustments Preset Recline Tension Pneumatic Seat Height Tilt Lock</p> <p>Single Paddle Adjustments Preset Recline Tension Pneumatic Seat Height</p>	2	CONFERENCE MECHANISM	1	SINGLE PADDLE MECHANISM	<p>3. Arm</p>  <p>Arm</p> <table border="0"> <tr> <td>00</td> <td>ARMLESS</td> </tr> <tr> <td>01</td> <td>HEIGHT ADJUSTABLE ARMS</td> </tr> <tr> <td>05</td> <td>FIXED HEIGHT T-ARM</td> </tr> <tr> <td>07</td> <td>FIXED HEIGHT D-ARM</td> </tr> </table> <div style="display: flex; justify-content: space-around; align-items: center;">  Armless  T-Arm  D-Arm </div> <div style="display: flex; justify-content: space-around; align-items: center;">   Height Adjustable Arms </div> <p>Height adjustable arms come standard with 45° inward rotation and urethane caps.</p>	00	ARMLESS	01	HEIGHT ADJUSTABLE ARMS	05	FIXED HEIGHT T-ARM	07	FIXED HEIGHT D-ARM	<p>4. Mesh</p>  <p>Mesh</p> <table border="0"> <tr> <td>M1</td> <td>BLACK</td> </tr> <tr> <td>M2</td> <td>BRONZE</td> </tr> <tr> <td>M3</td> <td>SILVER WHITE</td> </tr> <tr> <td>M4</td> <td>WARM GRAY</td> </tr> </table>	M1	BLACK	M2	BRONZE	M3	SILVER WHITE	M4	WARM GRAY	<p>5. Options</p>  <p>Options</p> <table border="0"> <tr> <td>01UC</td> <td>UPHOLSTERED ARM CAP FOR HEIGHT ADJUSTABLE ARM</td> <td>+72</td> </tr> <tr> <td>05UC</td> <td>UPHOLSTERED ARM CAP FOR T-ARM</td> <td>+72</td> </tr> <tr> <td>07UC</td> <td>UPHOLSTERED ARM CAP FOR D-ARM</td> <td>+173</td> </tr> <tr> <td>AC</td> <td>BLACK PLASTIC ARM CAP FOR D-ARM</td> <td>+32</td> </tr> <tr> <td>LU</td> <td>ADJUSTABLE LUMBAR PADS</td> <td>+58</td> </tr> </table> <div style="display: flex; align-items: center; margin-top: 10px;">  <div style="margin-left: 5px;">Adjustable lumbar pads for Mesh Backs</div> </div> <p>Upholstered arm caps must be leather, vinyl, or polyurethane. Height adjustment lock-out comes standard on all Sava chairs.</p>	01UC	UPHOLSTERED ARM CAP FOR HEIGHT ADJUSTABLE ARM	+72	05UC	UPHOLSTERED ARM CAP FOR T-ARM	+72	07UC	UPHOLSTERED ARM CAP FOR D-ARM	+173	AC	BLACK PLASTIC ARM CAP FOR D-ARM	+32	LU	ADJUSTABLE LUMBAR PADS	+58	<p>6. Caster</p>  <p>Caster</p> <table border="0"> <tr> <td>BC</td> <td>BLACK HARD WHEEL</td> </tr> <tr> <td>BS</td> <td>BLACK SOFT WHEEL +42</td> </tr> <tr> <td>CC</td> <td>CHROME TRIM +98</td> </tr> <tr> <td>CS</td> <td>CHROME TRIM SOFT WHEEL +123</td> </tr> <tr> <td>GA</td> <td>GLIDES W/ABS PADS +98</td> </tr> <tr> <td>GF</td> <td>GLIDES W/FELT PADS +98</td> </tr> </table>	BC	BLACK HARD WHEEL	BS	BLACK SOFT WHEEL +42	CC	CHROME TRIM +98	CS	CHROME TRIM SOFT WHEEL +123	GA	GLIDES W/ABS PADS +98	GF	GLIDES W/FELT PADS +98	<p>7. Arm Finish</p>  <p>Arm Finish</p> <table border="0"> <tr> <td>AL</td> <td>POLISHED ALUMINUM</td> </tr> <tr> <td>CH</td> <td>CHROME +473</td> </tr> <tr> <td>BM</td> <td>BLACK MATTE</td> </tr> </table> <p>Chrome finish is only available on Fixed Height D-Arms (07)</p> <p>Black Matte finish is only available on the Single Paddle control. Black Matte finish on arms is only available on Fixed Height T-Arm (05) or D-Arm (07).</p>	AL	POLISHED ALUMINUM	CH	CHROME +473	BM	BLACK MATTE	<p>8. Upholstery</p>  <p>See general information section for details on textile program and COM/ COL information.</p>
2	CONFERENCE MECHANISM																																																											
1	SINGLE PADDLE MECHANISM																																																											
00	ARMLESS																																																											
01	HEIGHT ADJUSTABLE ARMS																																																											
05	FIXED HEIGHT T-ARM																																																											
07	FIXED HEIGHT D-ARM																																																											
M1	BLACK																																																											
M2	BRONZE																																																											
M3	SILVER WHITE																																																											
M4	WARM GRAY																																																											
01UC	UPHOLSTERED ARM CAP FOR HEIGHT ADJUSTABLE ARM	+72																																																										
05UC	UPHOLSTERED ARM CAP FOR T-ARM	+72																																																										
07UC	UPHOLSTERED ARM CAP FOR D-ARM	+173																																																										
AC	BLACK PLASTIC ARM CAP FOR D-ARM	+32																																																										
LU	ADJUSTABLE LUMBAR PADS	+58																																																										
BC	BLACK HARD WHEEL																																																											
BS	BLACK SOFT WHEEL +42																																																											
CC	CHROME TRIM +98																																																											
CS	CHROME TRIM SOFT WHEEL +123																																																											
GA	GLIDES W/ABS PADS +98																																																											
GF	GLIDES W/FELT PADS +98																																																											
AL	POLISHED ALUMINUM																																																											
CH	CHROME +473																																																											
BM	BLACK MATTE																																																											

Sava

HIGH BACK: MESH BACK, UPHOLSTERED SEAT

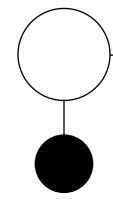
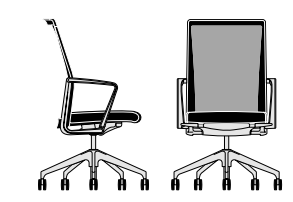
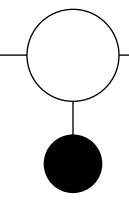
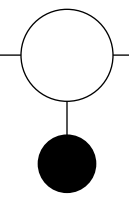
TITLE	STYLE	CTRL	ARM	HEIGHT	DIMENSIONS	YDG	SQFT	Textile Upholstery Grades										Leather Upholstery Grades								
								COM	COL	COM	COL	A	B	C	D	E	F	G	H	I	J	K	L	M	W	X
High Back, Mesh Back, Upholstered Seat, Conference Mechanism	Armless	SV28	2	00		19W x 26.5D x 37.5-42.5H	0.8	10	1696	1730	1769	1808	1845	1884	1922	1970	2016	2070	2148	2213	2276	1959	1998	2218	2306	2452
	Adjustable Arm	SV28	2	01		27.5W x 26.5D x 37.5-42.5H	0.8	10	2141	2180	2216	2253	2291	2330	2369	2418	2462	2518	2595	2660	2723	2407	2443	2691	2778	2922
	Fixed T-Arm	SV28	2	05		27.5W x 26.5D x 37.5-42.5H	0.8	10	1928	1962	2000	2038	2078	2116	2155	2202	2248	2302	2380	2445	2508	2193	2230	2464	2553	2695
	Fixed D-Arm	SV28	2	07		23.5W x 26.5D x 37.5-42.5H	0.8	10	1857	1895	1933	1970	2007	2046	2085	2133	2181	2233	2312	2377	2440	2125	2161	2392	2478	2624
High Back, Mesh Back, Upholstered Seat, Multi-Task Mechanism	Armless	SV28	4	00		19W x 26.5D x 37.5-42.5H	0.8	10	1813	1851	1888	1925	1960	2002	2042	2087	2135	2187	2265	2330	2393	2081	2117	2343	2432	2575
	Adjustable Arm	SV28	4	01		27.5W x 26.5D x 37.5-42.5H	0.8	10	2260	2297	2334	2371	2408	2450	2490	2535	2582	2634	2713	2778	2841	2527	2564	2818	2905	3046
	Fixed T-Arm	SV28	4	05		27.5W x 26.5D x 37.5-42.5H	0.8	10	2045	2083	2121	2158	2195	2234	2272	2322	2367	2421	2499	2564	2627	2312	2349	2590	2678	2821
	Fixed D-Arm	SV28	4	07		23.5W x 26.5D x 37.5-42.5H	0.8	10	1978	2013	2051	2087	2127	2166	2205	2253	2298	2353	2431	2496	2559	2242	2281	2519	2604	2748
High Back, Mesh Back, Upholstered Seat, Single Paddle Mechanism	Armless	SV28	1	00		19W x 26.5D x 37.5-42.5H	0.8	10	1419	1454	1491	1529	1566	1607	1644	1692	1739	1791	1869	1934	1997	1683	1720	1924	2012	2156
	Adjustable Arm	SV28	1	01		27.5W x 26.5D x 37.5-42.5H	0.8	10	1862	1901	1937	1975	2012	2053	2092	2138	2184	2238	2316	2381	2444	2129	2167	2396	2484	2628
	Fixed T-Arm	SV28	1	05		27.5W x 26.5D x 37.5-42.5H	0.8	10	1650	1685	1723	1760	1798	1838	1877	1924	1970	2023	2101	2166	2229	1915	1953	2169	2258	2401
	Fixed D-Arm	SV28	1	07		23.5W x 26.5D x 37.5-42.5H	0.8	10	1581	1618	1656	1692	1728	1769	1809	1855	1903	1955	2033	2098	2161	1847	1884	2097	2184	2330

To Order Select Below

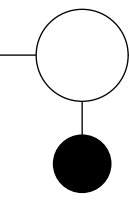
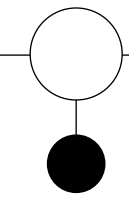
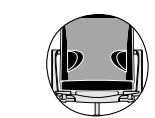
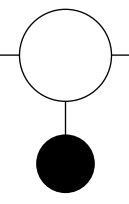
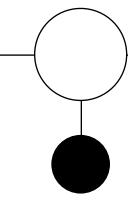
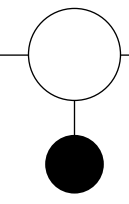



<p>1. Series/Back/Style</p>  <p>SV28</p> <p>Sava Chair High Back, Mesh Back, Upholstered Seat</p> 	<p>2. Control</p>  <p>Control</p> <table border="0"> <tr> <td>2</td> <td>CONFERENCE MECHANISM</td> </tr> <tr> <td>4</td> <td>MULTI-TASK MECHANISM</td> </tr> <tr> <td>1</td> <td>SINGLE PADDLE MECHANISM</td> </tr> </table> <p>Conference Adjustments Preset Recline Tension Pneumatic Seat Height Tilt Lock</p> <p>Multi-Task Adjustments 4-Position Tilt Tension Pneumatic Seat Height Tilt Lock Seat Depth</p> <p>Single Paddle Adjustments Preset Recline Tension Pneumatic Seat Height</p>	2	CONFERENCE MECHANISM	4	MULTI-TASK MECHANISM	1	SINGLE PADDLE MECHANISM	<p>3. Arm</p>  <p>Arm</p> <table border="0"> <tr> <td>00</td> <td>ARMLESS</td> </tr> <tr> <td>01</td> <td>HEIGHT ADJUSTABLE ARMS</td> </tr> <tr> <td>05</td> <td>FIXED HEIGHT T-ARM</td> </tr> <tr> <td>07</td> <td>FIXED HEIGHT D-ARM</td> </tr> </table> <div style="display: flex; justify-content: space-around; align-items: center;">  Armless  T-Arm  D-Arm </div> <div style="display: flex; justify-content: space-around; align-items: center;">  Height Adjustable Arms </div> <p>Height adjustable arms come standard with 45° inward rotation and urethane caps.</p>	00	ARMLESS	01	HEIGHT ADJUSTABLE ARMS	05	FIXED HEIGHT T-ARM	07	FIXED HEIGHT D-ARM	<p>4. Mesh</p>  <p>Mesh</p> <table border="0"> <tr> <td>M1</td> <td>BLACK</td> </tr> <tr> <td>M2</td> <td>BRONZE</td> </tr> <tr> <td>M3</td> <td>SILVER WHITE</td> </tr> <tr> <td>M4</td> <td>WARM GRAY</td> </tr> </table>	M1	BLACK	M2	BRONZE	M3	SILVER WHITE	M4	WARM GRAY	<p>5. Options</p>  <p>Options</p> <table border="0"> <tr> <td>01UC</td> <td>UPHOLSTERED ARM CAP FOR HEIGHT ADJUSTABLE ARM</td> <td>+72</td> </tr> <tr> <td>05UC</td> <td>UPHOLSTERED ARM CAP FOR T-ARM</td> <td>+72</td> </tr> <tr> <td>07UC</td> <td>UPHOLSTERED ARM CAP FOR D-ARM</td> <td>+173</td> </tr> <tr> <td>AC</td> <td>BLACK PLASTIC ARM CAP FOR D-ARM</td> <td>+32</td> </tr> <tr> <td>LU</td> <td>ADJUSTABLE LUMBAR PADS</td> <td>+58</td> </tr> <tr> <td>CT</td> <td>CONTRASTING THREAD</td> <td></td> </tr> </table>  <p>Adjustable lumbar pads for Mesh Backs</p> <p>Upholstered arm caps must be leather, vinyl, or polyurethane. Height adjustment lock-out comes standard on all Sava chairs.</p>	01UC	UPHOLSTERED ARM CAP FOR HEIGHT ADJUSTABLE ARM	+72	05UC	UPHOLSTERED ARM CAP FOR T-ARM	+72	07UC	UPHOLSTERED ARM CAP FOR D-ARM	+173	AC	BLACK PLASTIC ARM CAP FOR D-ARM	+32	LU	ADJUSTABLE LUMBAR PADS	+58	CT	CONTRASTING THREAD		<p>6. Caster</p>  <p>Caster</p> <table border="0"> <tr> <td>BC</td> <td>BLACK HARD WHEEL</td> </tr> <tr> <td>BS</td> <td>BLACK SOFT WHEEL +42</td> </tr> <tr> <td>CC</td> <td>CHROME TRIM +98</td> </tr> <tr> <td>CS</td> <td>CHROME TRIM SOFT WHEEL +123</td> </tr> <tr> <td>GA</td> <td>GLIDES W/ABS PADS +98</td> </tr> <tr> <td>GF</td> <td>GLIDES W/FELT PADS +98</td> </tr> </table>	BC	BLACK HARD WHEEL	BS	BLACK SOFT WHEEL +42	CC	CHROME TRIM +98	CS	CHROME TRIM SOFT WHEEL +123	GA	GLIDES W/ABS PADS +98	GF	GLIDES W/FELT PADS +98	<p>7. Arm Finish</p>  <p>Arm Finish</p> <table border="0"> <tr> <td>AL</td> <td>POLISHED ALUMINUM</td> </tr> <tr> <td>CH</td> <td>CHROME +473</td> </tr> <tr> <td>BM</td> <td>BLACK MATTE</td> </tr> </table> <p>Chrome finish is only available on Fixed Height D-Arms (07)</p> <p>Black Matte finish is only available on the Single Paddle control. Black Matte finish on arms is only available on Fixed Height T-Arm (05) or D-Arm (07).</p>	AL	POLISHED ALUMINUM	CH	CHROME +473	BM	BLACK MATTE	<p>8. Upholstery</p>  <p>See general information section for details on textile program and COM/ COL information.</p>
2	CONFERENCE MECHANISM																																																																
4	MULTI-TASK MECHANISM																																																																
1	SINGLE PADDLE MECHANISM																																																																
00	ARMLESS																																																																
01	HEIGHT ADJUSTABLE ARMS																																																																
05	FIXED HEIGHT T-ARM																																																																
07	FIXED HEIGHT D-ARM																																																																
M1	BLACK																																																																
M2	BRONZE																																																																
M3	SILVER WHITE																																																																
M4	WARM GRAY																																																																
01UC	UPHOLSTERED ARM CAP FOR HEIGHT ADJUSTABLE ARM	+72																																																															
05UC	UPHOLSTERED ARM CAP FOR T-ARM	+72																																																															
07UC	UPHOLSTERED ARM CAP FOR D-ARM	+173																																																															
AC	BLACK PLASTIC ARM CAP FOR D-ARM	+32																																																															
LU	ADJUSTABLE LUMBAR PADS	+58																																																															
CT	CONTRASTING THREAD																																																																
BC	BLACK HARD WHEEL																																																																
BS	BLACK SOFT WHEEL +42																																																																
CC	CHROME TRIM +98																																																																
CS	CHROME TRIM SOFT WHEEL +123																																																																
GA	GLIDES W/ABS PADS +98																																																																
GF	GLIDES W/FELT PADS +98																																																																
AL	POLISHED ALUMINUM																																																																
CH	CHROME +473																																																																
BM	BLACK MATTE																																																																

Sava

HIGH BACK: STANDARD UPHOLSTERY BACK, UPHOLSTERED SEAT

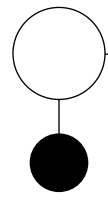
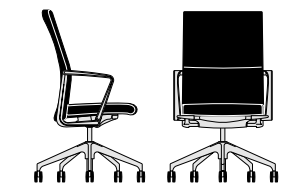
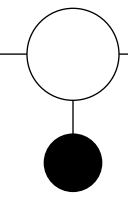
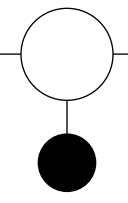
TITLE	STYLE	CTRL	ARM	HEIGHT	DIMENSIONS	YDG	SQFT	Textile Upholstery Grades				Leather Upholstery Grades													
								COM	COL	COM	COL	A	B	C	D	E	F	G	H	I	J	K	L	M	W
High Back, Standard Upholstery Back, Upholstered Seat, Conference Mechanism	Armless	SV48	2	00	19W x 26.5D x 37.5-42.5H	1.7	25	1924	2003	2084	2163	2246	2331	2418	2520	2621	2733	2904	3045	3181	2699	2804	3264	3510	3925
	Adjustable Arm	SV48	2	01	27.5W x 26.5D x 37.5-42.5H	1.7	25	2378	2460	2540	2619	2703	2787	2873	2976	3075	3190	3360	3501	3637	3155	3258	3749	3993	4407
	Fixed T-Arm	SV48	2	05	27.5W x 26.5D x 37.5-42.5H	1.7	25	2160	2241	2322	2399	2483	2567	2654	2755	2858	2972	3141	3282	3418	2936	3042	3514	3761	4176
	Fixed D-Arm	SV48	2	07	23.5W x 26.5D x 37.5-42.5H	1.7	25	2087	2171	2250	2330	2414	2498	2584	2687	2787	2901	3072	3213	3350	2867	2972	3443	3689	4100
High Back, Standard Upholstery Back, Upholstered Seat, Multi-Task Mechanism	Armless	SV48	4	00	19W x 26.5D x 37.5-42.5H	1.7	25	2043	2127	2206	2284	2368	2454	2539	2641	2742	2855	3026	3167	3303	2820	2925	3396	3641	4053
	Adjustable Arm	SV48	4	01	27.5W x 26.5D x 37.5-42.5H	1.7	25	2498	2582	2661	2739	2822	2910	2994	3099	3198	3309	3482	3622	3759	3275	3382	3878	4123	4535
	Fixed T-Arm	SV48	4	05	27.5W x 26.5D x 37.5-42.5H	1.7	25	2280	2363	2442	2521	2605	2690	2776	2879	2978	3091	3262	3403	3539	3057	3161	3645	3892	4304
	Fixed D-Arm	SV48	4	07	23.5W x 26.5D x 37.5-42.5H	1.7	25	2209	2293	2373	2453	2536	2621	2705	2809	2910	3022	3194	3335	3471	2986	3093	3570	3817	4228
High Back, Standard Upholstery Back, Upholstered Seat, Single Paddle Mechanism	Armless	SV48	1	00	19W x 26.5D x 37.5-42.5H	1.7	25	1642	1720	1803	1881	1966	2046	2135	2237	2337	2452	2621	2762	2898	2415	2521	2964	3210	3626
	Adjustable Arm	SV48	1	01	27.5W x 26.5D x 37.5-42.5H	1.7	25	2095	2178	2256	2335	2420	2503	2590	2691	2792	2907	3076	3217	3353	2872	2977	3446	3694	4108
	Fixed T-Arm	SV48	1	05	27.5W x 26.5D x 37.5-42.5H	1.7	25	1877	1956	2038	2116	2200	2284	2370	2472	2574	2687	2857	2998	3134	2653	2756	3215	3462	3875
	Fixed D-Arm	SV48	1	07	23.5W x 26.5D x 37.5-42.5H	1.7	25	1806	1887	1969	2045	2132	2216	2300	2405	2503	2618	2788	2929	3066	2584	2687	3144	3388	3801

To Order Select Below

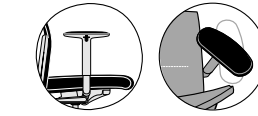
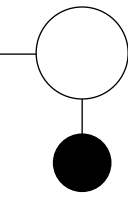
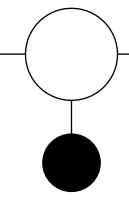
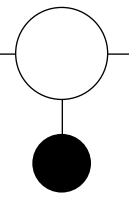
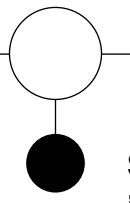



<p>1. Series/Back/Style</p>  <p>SV48</p> <p>Sava Chair High Back, Standard Upholstery Back, Upholstered Seat</p> 	<p>2. Control</p>  <p>Control</p> <p>2 CONFERENCE MECHANISM</p> <p>4 MULTI-TASK MECHANISM</p> <p>1 SINGLE PADDLE MECHANISM</p> <p>Conference Adjustments Preset Recline Tension Pneumatic Seat Height Tilt Lock</p> <p>Multi-Task Adjustments 4-Position Tilt Tension Pneumatic Seat Height Tilt Lock Seat Depth</p> <p>Single Paddle Adjustments Preset Recline Tension Pneumatic Seat Height</p>	<p>3. Arm</p>  <p>Arm</p> <p>00 ARMLESS</p> <p>01 HEIGHT ADJUSTABLE ARMS</p> <p>05 FIXED HEIGHT T-ARM</p> <p>07 FIXED HEIGHT D-ARM</p> <p> Armless  T-Arm  D-Arm</p> <p> Height Adjustable Arms</p> <p>Height adjustable arms come standard with 45° inward rotation and urethane caps.</p>	<p>4. Options</p>  <p>Options</p> <p>01UC UPHOLSTERED ARM CAP FOR HEIGHT ADJUSTABLE ARM +72</p> <p>05UC UPHOLSTERED ARM CAP FOR T-ARM +72</p> <p>07UC UPHOLSTERED ARM CAP FOR D-ARM +173</p> <p>AC BLACK PLASTIC ARM CAP FOR D-ARM +32</p> <p>CT CONTRASTING THREAD</p> <p>Upholstered arm caps must be leather, vinyl, or polyurethane. Height adjustment lock-out comes standard on all Sava chairs.</p>	<p>5. Caster</p>  <p>Caster</p> <p>BC BLACK HARD WHEEL</p> <p>BS BLACK SOFT WHEEL +42</p> <p>CC CHROME TRIM +98</p> <p>CS CHROME TRIM SOFT WHEEL +123</p> <p>GA GLIDES W/ABS PADS +98</p> <p>GF GLIDES W/FELT PADS +98</p>	<p>6. Arm Finish</p>  <p>Arm Finish</p> <p>AL POLISHED ALUMINUM</p> <p>CH CHROME +473</p> <p>BM BLACK MATTE</p> <p>Chrome finish is only available on Fixed Height D-Arms (07)</p> <p>Black Matte finish is only available on the Single Paddle control. Black Matte finish on arms is only available on Fixed Height T-Arm (05) or D-Arm (07).</p>	<p>7. Upholstery</p>  <p>See general information section for details on textile program and COM/ COL information.</p>
---	--	--	---	--	---	--

Sava

HIGH BACK: EURO UPHOLSTERY BACK, EURO UPHOLSTERY SEAT

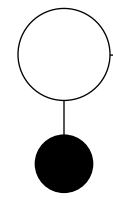
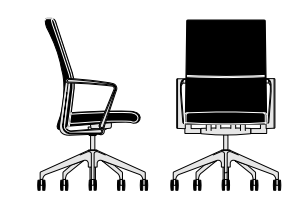
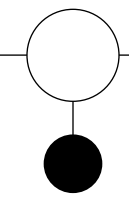
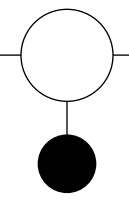
TITLE	STYLE	CTRL	ARM	HEIGHT	DIMENSIONS	YDG	SQFT	Textile Upholstery Grades										Leather Upholstery Grades							
								COM	COL	COM	COL	A	B	C	D	E	F	G	H	I	J	K	L	M	W
High Back, Euro Upholstery Back, Euro Upholstery Seat, Conference Mechanism	Armless	SV58	2	00	19W x 26.5D x 37.5-42.5H	1.7	25	1924	2003	2084	2163	2246	2331	2418	2520	2621	2733	2904	3045	3181	2699	2804	3264	3510	3925
	Adjustable Arm	SV58	2	01	27.5W x 26.5D x 37.5-42.5H	1.7	25	2378	2460	2540	2619	2703	2787	2873	2976	3075	3190	3360	3501	3637	3155	3258	3749	3993	4407
	Fixed T-Arm	SV58	2	05	27.5W x 26.5D x 37.5-42.5H	1.7	25	2160	2241	2322	2399	2483	2567	2654	2755	2858	2972	3141	3282	3418	2936	3042	3514	3761	4176
	Fixed D-Arm	SV58	2	07	23.5W x 26.5D x 37.5-42.5H	1.7	25	2087	2171	2250	2330	2414	2498	2584	2687	2787	2901	3072	3213	3350	2867	2972	3443	3689	4100
High Back, Euro Upholstery Back, Euro Upholstery Seat, Multi-Task Mechanism	Armless	SV58	4	00	19W x 26.5D x 37.5-42.5H	1.7	25	2043	2127	2206	2284	2368	2454	2539	2641	2742	2855	3026	3167	3303	2820	2925	3396	3641	4053
	Adjustable Arm	SV58	4	01	27.5W x 26.5D x 37.5-42.5H	1.7	25	2498	2582	2661	2739	2822	2910	2994	3099	3198	3309	3482	3622	3759	3275	3382	3878	4123	4535
	Fixed T-Arm	SV58	4	05	27.5W x 26.5D x 37.5-42.5H	1.7	25	2280	2363	2442	2521	2605	2690	2776	2879	2978	3091	3262	3403	3539	3057	3161	3645	3892	4304
	Fixed D-Arm	SV58	4	07	23.5W x 26.5D x 37.5-42.5H	1.7	25	2209	2293	2373	2453	2536	2621	2705	2809	2910	3022	3194	3335	3471	2986	3093	3570	3817	4228
High Back, Euro Upholstery Back, Euro Upholstery Seat, Single Paddle Mechanism	Armless	SV58	1	00	19W x 26.5D x 37.5-42.5H	1.7	25	1642	1720	1803	1881	1966	2046	2135	2237	2337	2452	2621	2762	2898	2415	2521	2964	3210	3626
	Adjustable Arm	SV58	1	01	27.5W x 26.5D x 37.5-42.5H	1.7	25	2095	2178	2256	2335	2420	2503	2590	2691	2792	2907	3076	3217	3353	2872	2977	3446	3694	4108
	Fixed T-Arm	SV58	1	05	27.5W x 26.5D x 37.5-42.5H	1.7	25	1877	1956	2038	2116	2200	2284	2370	2472	2574	2687	2857	2998	3134	2653	2756	3215	3462	3875
	Fixed D-Arm	SV58	1	07	23.5W x 26.5D x 37.5-42.5H	1.7	25	1806	1887	1969	2045	2132	2216	2300	2405	2503	2618	2788	2929	3066	2584	2687	3144	3388	3801

To Order Select Below

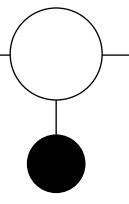
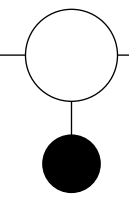
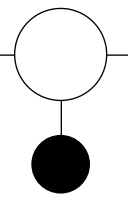
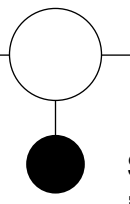



<p>1. Series/Back/Style</p>  <p>SV58</p> <p>Sava Chair High Back, Euro Upholstery Back Euro Upholstery Seat</p> 	<p>2. Control</p>  <p>Control</p> <table border="0"> <tr> <td>2</td> <td>CONFERENCE MECHANISM</td> </tr> <tr> <td>4</td> <td>MULTI-TASK MECHANISM</td> </tr> <tr> <td>1</td> <td>SINGLE PADDLE MECHANISM</td> </tr> </table> <p>Conference Adjustments Preset Recline Tension Pneumatic Seat Height Tilt Lock</p> <p>Multi-Task Adjustments 4-Position Tilt Tension Pneumatic Seat Height Tilt Lock Seat Depth</p> <p>Single Paddle Adjustments Preset Recline Tension Pneumatic Seat Height</p>	2	CONFERENCE MECHANISM	4	MULTI-TASK MECHANISM	1	SINGLE PADDLE MECHANISM	<p>3. Arm</p>  <p>Arm</p> <table border="0"> <tr> <td>00</td> <td>ARMLESS</td> </tr> <tr> <td>01</td> <td>HEIGHT ADJUSTABLE ARMS</td> </tr> <tr> <td>05</td> <td>FIXED HEIGHT T-ARM</td> </tr> <tr> <td>07</td> <td>FIXED HEIGHT D-ARM</td> </tr> </table> <div style="display: flex; justify-content: space-around; align-items: center;">  Armless  T-Arm  D-Arm </div> <div style="display: flex; justify-content: space-around; align-items: center;">  Height Adjustable Arms </div> <p>Height adjustable arms come standard with 45° inward rotation and urethane caps.</p>	00	ARMLESS	01	HEIGHT ADJUSTABLE ARMS	05	FIXED HEIGHT T-ARM	07	FIXED HEIGHT D-ARM	<p>4. Options</p>  <p>Options</p> <table border="0"> <tr> <td>01UC</td> <td>UPHOLSTERED ARM CAP FOR HEIGHT ADJUSTABLE ARM</td> <td>+72</td> </tr> <tr> <td>05UC</td> <td>UPHOLSTERED ARM CAP FOR T-ARM</td> <td>+72</td> </tr> <tr> <td>07UC</td> <td>UPHOLSTERED ARM CAP FOR D-ARM</td> <td>+173</td> </tr> <tr> <td>AC</td> <td>BLACK PLASTIC ARM CAP FOR D-ARM</td> <td>+32</td> </tr> <tr> <td>CT</td> <td>CONTRASTING THREAD</td> <td></td> </tr> </table> <p>Upholstered arm caps must be leather, vinyl, or polyurethane. Height adjustment lock-out comes standard on all Sava chairs.</p>	01UC	UPHOLSTERED ARM CAP FOR HEIGHT ADJUSTABLE ARM	+72	05UC	UPHOLSTERED ARM CAP FOR T-ARM	+72	07UC	UPHOLSTERED ARM CAP FOR D-ARM	+173	AC	BLACK PLASTIC ARM CAP FOR D-ARM	+32	CT	CONTRASTING THREAD		<p>5. Caster</p>  <p>Caster</p> <table border="0"> <tr> <td>BC</td> <td>BLACK HARD WHEEL</td> </tr> <tr> <td>BS</td> <td>BLACK SOFT WHEEL +42</td> </tr> <tr> <td>CC</td> <td>CHROME TRIM +98</td> </tr> <tr> <td>CS</td> <td>CHROME TRIM SOFT WHEEL +123</td> </tr> <tr> <td>GA</td> <td>GLIDES W/ABS PADS +98</td> </tr> <tr> <td>GF</td> <td>GLIDES W/FELT PADS +98</td> </tr> </table>	BC	BLACK HARD WHEEL	BS	BLACK SOFT WHEEL +42	CC	CHROME TRIM +98	CS	CHROME TRIM SOFT WHEEL +123	GA	GLIDES W/ABS PADS +98	GF	GLIDES W/FELT PADS +98	<p>6. Arm Finish</p>  <p>Arm Finish</p> <table border="0"> <tr> <td>AL</td> <td>POLISHED ALUMINUM</td> </tr> <tr> <td>CH</td> <td>CHROME +473</td> </tr> <tr> <td>BM</td> <td>BLACK MATTE</td> </tr> </table> <p>Chrome finish is only available on Fixed Height D-Arms (07)</p> <p>Black Matte finish is only available on the Single Paddle control. Black Matte finish on arms is only available on Fixed Height T-Arm (05) or D-Arm (07).</p>	AL	POLISHED ALUMINUM	CH	CHROME +473	BM	BLACK MATTE	<p>7. Upholstery</p>  <p>See general information section for details on textile program and COM/ COL information.</p>
2	CONFERENCE MECHANISM																																																				
4	MULTI-TASK MECHANISM																																																				
1	SINGLE PADDLE MECHANISM																																																				
00	ARMLESS																																																				
01	HEIGHT ADJUSTABLE ARMS																																																				
05	FIXED HEIGHT T-ARM																																																				
07	FIXED HEIGHT D-ARM																																																				
01UC	UPHOLSTERED ARM CAP FOR HEIGHT ADJUSTABLE ARM	+72																																																			
05UC	UPHOLSTERED ARM CAP FOR T-ARM	+72																																																			
07UC	UPHOLSTERED ARM CAP FOR D-ARM	+173																																																			
AC	BLACK PLASTIC ARM CAP FOR D-ARM	+32																																																			
CT	CONTRASTING THREAD																																																				
BC	BLACK HARD WHEEL																																																				
BS	BLACK SOFT WHEEL +42																																																				
CC	CHROME TRIM +98																																																				
CS	CHROME TRIM SOFT WHEEL +123																																																				
GA	GLIDES W/ABS PADS +98																																																				
GF	GLIDES W/FELT PADS +98																																																				
AL	POLISHED ALUMINUM																																																				
CH	CHROME +473																																																				
BM	BLACK MATTE																																																				

Sava

HIGH BACK: THIN PAD BACK, THIN PAD SEAT

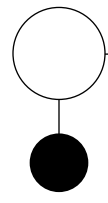
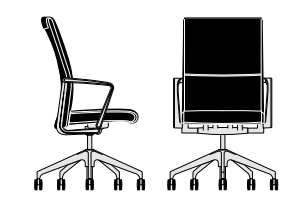
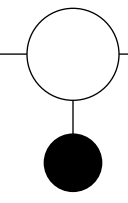
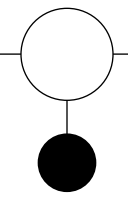
TITLE	STYLE	CTRL	ARM	HEIGHT	DIMENSIONS	YDG	SQFT	Textile Upholstery Grades										Leather Upholstery Grades								
								COM	COL	COM	COL	A	B	C	D	E	F	G	H	I	J	K	L	M	W	X
High Back, Thin Pad Back, Thin Pad Seat, Conference Mechanism	Armless	SV78	2	00		19W x 26.5D x 37.5-42.5H	2.2	40	2186	2305	2414	2523	2639	2754	2873	3018	3156	3311	3548	3743	3932	3335	3600	4194	4602	5338
	Adjustable Arm	SV78	2	01		27.5W x 26.5D x 37.5-42.5H	2.2	40	2674	2791	2901	3008	3123	3240	3360	3503	3640	3797	4033	4227	4416	3772	4039	4632	5040	5774
	Fixed T-Arm	SV78	2	05		27.5W x 26.5D x 37.5-42.5H	2.2	40	2441	2555	2667	2777	2891	3007	3125	3270	3407	3563	3800	3994	4182	3571	3837	4431	4837	5573
	Fixed D-Arm	SV78	2	07		23.5W x 26.5D x 37.5-42.5H	2.2	40	2367	2482	2592	2703	2818	2933	3051	3193	3332	3488	3724	3918	4106	3493	3761	4354	4763	5497
High Back, Thin Pad Back, Thin Pad Seat, Multi-Task Mechanism	Armless	SV78	4	00		19W x 26.5D x 37.5-42.5H	2.2	40	2318	2433	2543	2654	2767	2885	3004	3146	3283	3440	3676	3871	4059	3450	3717	4311	4718	5454
	Adjustable Arm	SV78	4	01		27.5W x 26.5D x 37.5-42.5H	2.2	40	2804	2918	3028	3142	3254	3371	3488	3631	3771	3926	4163	4357	4546	3888	4154	4749	5156	5892
	Fixed T-Arm	SV78	4	05		27.5W x 26.5D x 37.5-42.5H	2.2	40	2569	2685	2795	2906	3020	3138	3255	3400	3537	3692	3930	4125	4313	3688	3954	4548	4955	5689
	Fixed D-Arm	SV78	4	07		23.5W x 26.5D x 37.5-42.5H	2.2	40	2497	2611	2721	2833	2947	3064	3180	3322	3464	3618	3854	4049	4237	3610	3879	4473	4877	5613
High Back, Thin Pad Back, Thin Pad Seat, Single Paddle Mechanism	Armless	SV78	1	00		19W x 26.5D x 37.5-42.5H	2.2	40	1886	2000	2112	2223	2336	2454	2569	2715	2854	3008	3245	3440	3628	3051	3317	3912	4318	5055
	Adjustable Arm	SV78	1	01		27.5W x 26.5D x 37.5-42.5H	2.2	40	2372	2490	2597	2706	2821	2938	3057	3203	3340	3493	3731	3926	4114	3489	3756	4349	4758	5490
	Fixed T-Arm	SV78	1	05		27.5W x 26.5D x 37.5-42.5H	2.2	40	2138	2253	2366	2473	2590	2705	2822	2965	3105	3262	3497	3692	3880	3288	3554	4149	4554	5290
	Fixed D-Arm	SV78	1	07		23.5W x 26.5D x 37.5-42.5H	2.2	40	2065	2180	2291	2399	2517	2631	2749	2892	3029	3186	3422	3616	3804	3210	3478	4073	4595	5213

To Order Select Below

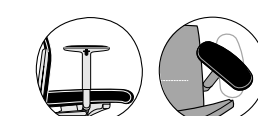
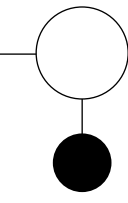
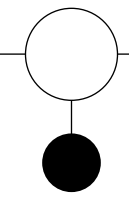
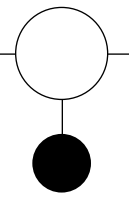
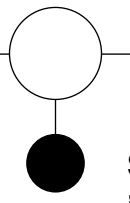
<p>1. Series/Back/Style</p>  <p>SV78</p> <p>Sava Chair High Back, Thin Pad Back, Thin Pad Seat</p> 	<p>2. Control</p>  <p>Control</p> <p>2 CONFERENCE MECHANISM</p> <p>4 MULTI-TASK MECHANISM</p> <p>1 SINGLE PADDLE MECHANISM</p> <p>Conference Adjustments Preset Recline Tension Pneumatic Seat Height Tilt Lock</p> <p>Multi-Task Adjustments 4-Position Tilt Tension Pneumatic Seat Height Tilt Lock Seat Depth</p> <p>Single Paddle Adjustments Preset Recline Tension Pneumatic Seat Height</p>	<p>3. Arm</p>  <p>Arm</p> <p>00 ARMLESS</p> <p>01 HEIGHT ADJUSTABLE ARMS</p> <p>05 FIXED HEIGHT T-ARM</p> <p>07 FIXED HEIGHT D-ARM</p>  Armless  T-Arm  D-Arm  Height Adjustable Arms <p>Height adjustable arms come standard with 45° inward rotation and urethane caps.</p>	<p>4. Options</p>  <p>Options</p> <p>01UC UPHOLSTERED ARM CAP FOR HEIGHT ADJUSTABLE ARM +72</p> <p>05UC UPHOLSTERED ARM CAP FOR T-ARM +72</p> <p>07UC UPHOLSTERED ARM CAP FOR D-ARM +173</p> <p>AC BLACK PLASTIC ARM CAP FOR D-ARM +32</p> <p>CT CONTRASTING THREAD</p> <p>Upholstered arm caps must be leather, vinyl, or polyurethane. Height adjustment lock-out comes standard on all Sava chairs.</p>	<p>5. Caster</p>  <p>Caster</p> <p>BC BLACK HARD WHEEL</p> <p>BS BLACK SOFT WHEEL +42</p> <p>CC CHROME TRIM +98</p> <p>CS CHROME TRIM SOFT WHEEL +123</p> <p>GA GLIDES W/ABS PADS +98</p> <p>GF GLIDES W/FELT PADS +98</p>	<p>6. Arm Finish</p>  <p>Arm Finish</p> <p>AL POLISHED ALUMINUM</p> <p>CH CHROME +473</p> <p>BM BLACK MATTE</p> <p>Chrome finish is only available on Fixed Height D-Arms (07)</p> <p>Black Matte finish is only available on the Single Paddle control. Black Matte finish on arms is only available on Fixed Height T-Arm (05) or D-Arm (07).</p>	<p>7. Upholstery</p>  <p>See general information section for details on textile program and COM/ COL information.</p>
---	--	---	---	--	---	--