

stylex

Obair Tables

PRICE LIST

Effective November 01, 2023

General Information

STYLEX PRICE LIST

GENERAL INFORMATION

Terms

Net 30 days from date of invoice,
F. O. B . Delanco, New Jersey.

Damaged Shipments

All Stylex products are carefully inspected before they are packed in sturdy cartons designed to satisfy shipping requirements. Stylex is not responsible for damage in shipment. The transportation company assumes responsibility for delivering products to you in good condition when the bill of lading is signed. You protect yourself by refusing shipments showing damage or shortage until transportation company has noted on the delivery sheet the extent of damage or shortage. Concealed damage should be reported to the carrier as soon as discovered, but no later than 5 days after receiving shipment.

Return/Restocking Policy

Return shipments will not be accepted unless specifically authorized by Stylex in writing. The Return Authorization number should be clearly marked on the carton. The customer returning Stylex products is responsible for return shipping costs. Merchandise must be returned unused. Returned merchandise is subject to a 35% restocking fee.

Custom Products

Modifications to standard products will be considered for large runs. Contact factory for price quotations.

Design Changes

In keeping with modern manufacturing advances, Stylex reserves the right to incorporate minor modifications and design changes in products without notice.

Cancellation/Change Order Policy

Regarding requests for order cancellation and/or order modification, please be advised that no charges will be applied before production, unless inventory has been specifically requisitioned to fulfill your order. Once orders proceed to the production phase, they cannot be altered or canceled under any circumstances. All requests for order cancellations or order changes must be submitted in writing and will only be considered valid upon approval by Stylex.

WARRANTY

Except as provided below, Stylex warrants exclusively to the original Purchaser of our product that all parts, under normal use and service, will be free from defects in workmanship and material for a period of ten (10) years from the date of purchase. "Normal use and service" means that the product will be used in a typical office environment for 40-45 hours per week.

This warranty is subject to the following limitations, exclusions and provisions:

Limitations involving materials and components:

Wood components of plywood stacking chairs
(such as Brooks and Welcome)
5 years

Upholstery

(including mesh used for Click, F4, Insight, and Zephyr Mesh)
3 years

SAVA Mesh

10 years

COM Upholstery

No warranty
Stylex makes every effort to ensure that the COM Upholstery it approves is suitable for the intended use. Nevertheless, we will not warrant, and assume no responsibility for, the durability or tailoring quality of any COM or COL . If you have any concerns about the ultimate appearance of any covering, please order an upholstered sample.

Painted Stack Chair Frames

No Warranty

We will not warrant the finish of painted stack chair frames against damage from stacking. Please order chrome frames for chairs that will be stacked.

Felt Glides

No warranty

Due to the different surfaces on which felt glides may be used, we cannot warrant their durability over time.

If this product fails during normal use and service within the applicable warranty period (other than through normal wear and tear), please send a description of the relevant part and the nature of the defect, together with proof of purchase of the product to qm@stylexdesign.com. PLEASE DO NOT RETURN PARTS OR THE PRODUCT TO STYLEX UNLESS INSTRUCTED TO DO SO BY STYLEX. Stylex will, at its discretion, either repair or replace the defective product or part at no cost. Labor requests must receive approval and will be authorized on a case-by-case basis. We will only reimburse for labor costs directly incurred, excluding any travel-related expenses. Purchaser may be required (at the option of Stylex) to return to Stylex at Purchaser's expense any defective part with all freight or shipping charges prepaid. The foregoing warranty shall be void if the product has been altered or repaired (other than by Stylex). The warranty does not cover damage to the product caused by accident, neglect, misuse, abuse, modification to the product by anyone other than Stylex or damage caused by use of the product for a purpose other than that for which it was designed. This warranty extends only to the original Purchaser of the product.

No Other Warranties

This warranty is in lieu of all other warranties, expressed or implied, including, but not limited to, implied warranties of merchantability and fitness for a particular purpose. The rights and remedies provided herein are the exclusive rights and remedies of the original purchaser of the product.

No Liability For Damages

In no event shall Stylex or its suppliers be responsible or liable for any special, indirect, consequential, or incidental damages. In no event shall the liability of Stylex exceed the actual purchase price paid to Stylex for the product.

Out of Warranty Products

For all products no longer covered by our warranty, please refer to our Design for Durability and Upgradability Policy. Contact Customer Service if you would like to purchase any replaceable components to further extend the life of any Stylex seating product. This warranty applies to all Stylex products purchased on April 13, 2018, and thereafter.

PRODUCT TAKE BACK PROGRAM

In order to be good stewards of our products, Stylex offers a pathway towards a Product Take Back Program as a more viable solution to the end of our products' originally intended life.

Stylex supports the sustainable programs of ANEW and offers their added value to our clients through a comprehensive take-back solution for surplus office furniture and materials of any kind, in any condition. ANEW is a 501(c)(3) non-profit organization that exists to provide companies with smart, cost effective alternatives for their surplus furniture and other items with the priority of matching it to non- profits, public agencies and the underserved, within the local community of the project site. Corporate Social Responsibility is raised while the impact on the environment is lowered by diverting products and materials otherwise destined for landfill.

Stylex is proud to offer ANEW to customers dedicated to strengthening their community network by repurposing their furniture, fixtures and architectural materials to those in need. In 2014, Stylex committed to making this relationship a part of our strategic sales strategy. Visit www.anewfound.org to find out more.

To initiate a Product Take Back strategy through ANEW, contact Stylex Customer Service at 800-257-5742.

For other end of life recovery options, please see our Product Disassembly Instructions and End of Life Recovery Options documents available on our website in the resources section of each product in our line.

FREIGHT PROGRAM

Freight charges will be calculated as a percentage of the net product price and added to the invoice at the time of shipment. The continental United States has been divided into three zones. Please use the map below to determine freight charges for the product's destination. Minimum freight charge is \$150. Please let us know if you will be shipping to a residential address or require inside delivery as this requires an additional fee. Also please note we need to be made aware if a liftgate is required prior to delivery. If any requests are made at the time of delivery, applicable charges will apply.

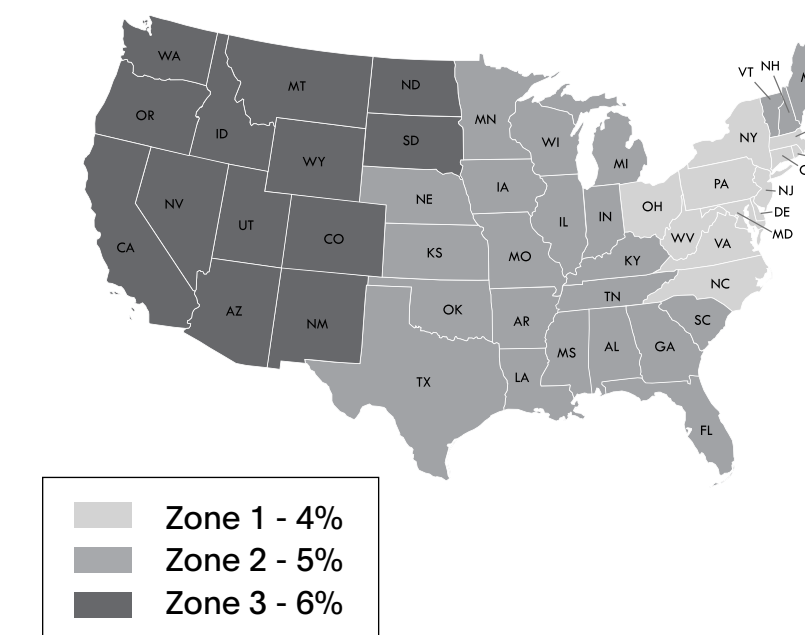

ZONE 1 - 4%

Connecticut
Delaware
New York
New Jersey
Maryland
Massachusetts
North Carolina
Ohio
Pennsylvania
Rhode Island
Virginia
Washington D.C.
West Virginia

ZONE 2 - 5%

Alabama
Arkansas
Canada, Ontario
Canada, Quebec
Florida
Georgia
Iowa
Illinois
Indiana
Kansas
Kentucky
Louisiana
Nebraska
New Hampshire
Oklahoma
Maine
Michigan
Minnesota
Missouri
Mississippi
South Carolina
Tennessee
Texas
Vermont
Wisconsin

ZONE 3 - 6%

Arizona
California
Colorado
Idaho
Montana
Nevada
New Mexico
North Dakota
Oregon
South Dakota
Utah
Washington
Wyoming

Quote Per Project

Alaska
Hawaii
Canada
(outside Ontario & Quebec)
Mexico

General Information

STYLEX PRICE LIST

TEXTILE PARTNERS & APPROVALS

Textile Partners

To customize your furniture performance needs and design vision, Stylex offers a wide selection of in-graded leathers and textiles from Grades A through Y. We've partnered with leading manufacturers on the options, focusing on color, price, durability, and construction. To view our partners and explore our digital carded program with broadly approved textiles, visit [this page](#). We stand by these textiles: They're tried and tested, and will effortlessly fit into any design aesthetic.

Textile Approvals

All textiles must be approved for the product you are specifying. For the related approved textile lists, visit [this page](#).

CAL 117 AND 133 COMPLIANCE

CAL 117-2013

All Stylex seating satisfies the requirements of CAL 117-2013 so long as one of our standard or in-graded fabrics is applied. COM textiles cannot be so guaranteed. Please contact the supplier of COM's directly to determine the fire retardancy of any COM supplied to us.

CAL 133

Most Stylex seating can be ordered to meet the requirements of CAL 133. When ordering, simply specify "CAL 133 compliance required". The upcharge for this option is \$54 list per yard. Please refer to the COM yardage of each model to determine the number of yards required. We do frequently require full-scale burn tests in order to certify CAL 133 before an order will be accepted. Such burn tests may increase normal lead times and do carry additional charges. Please contact customer service for details.

CUSTOMER'S OWN MATERIAL/LEATHER

Customer's own material (COM) and customer's own leather (COL) will generally be upholstered at the price designated in each product's price list. Please be advised, however, that we specifically reserve the right to charge a higher price when we determine that special circumstances, such as unusual repeats or challenging materials, present themselves. All orders for custom coverings must be approved by Stylex before they will be accepted for production. To submit proposed textile for approval, please use the COM form [here](#).

Special Note:

We assume no responsibility for the durability or tailoring quality of any COM or COL. Directional covers in particular may not meet your satisfaction due to the design of certain products. Please be advised that COM and COL orders are not subject to return. If you have doubts about the ultimate appearance of certain coverings, please order a sample done with that specific COM or COL. In addition, while we inspect fabrics for mill imperfections, some are difficult to recognize. We cannot be responsible for defects, color inaccuracies, dye lot variations, or other flaws.

Under no circumstances will we be responsible for COM shortages, flaws, or other such problems. Finally, it is not our responsibility to police the receipt of COM's in order to meet delivery deadlines, and we assume our customers are aware of any undue delay in the shipment of their COM fabrics.

COM fabric and COL leather should be sent prepaid to: Stylex

**Attn: COM/COL - [Your PO #]
740 Coopertown Road
Delanco, NJ 08075**

Clearly mark fabric or leather with the dealers name, purchase order number, and furniture model number of the item to be covered. Actual furniture orders should include the same information, as well as a description of the fabric or leather, including pattern and color number, in order to provide a cross reference.

Yardage requirements shown in the price list are based on non-directional goods of 54" width. Fabrics less than 54" wide or those requiring matching (stripes, prints, or large patterned designs) call for additional yardage. We will be happy to supply yardage requirements for large quantities where economies may be realized.

Add the following yardage for stripes, plaids, or patterns with repeats:

Fabric Width	Plain Fabric	2-14" Repeat	15-24" Repeat	25-27" Repeat	28-36" Repeat
54"	0%	10%	15%	20%	25%
50"	10%	20%	25%	30%	35%
48"	15%	25%	30%	35%	40%
45"	40%	50%	55%	60%	65%
36"	50%	60%	65%	70%	75%

COM/COL FORM

To avoid delay in processing COM orders we request that you submit a sample of your COM fabric stapled to this form which can be downloaded [here](#). If a fabric has a stripe or design, the size of the repeat should be indicated. Please indicate the fabric supplier's name, fabric number, and color. Also indicate the Stylex product on which the fabric will be used.

The fabric supplier must indicate on his shipping labels the dealer name and purchase order number as well as the Stylex model number.

Please Note:

No order may be entered into production or have a shipping date assigned until all related COM is received at the factory.



CENTER OF STRIPE OR DESIGN

TOP OF CHAIR	TOP OF CHAIR
--------------	--------------

1. Size of Repeat

2. Fabric Supplier

3. Fabric Number

4. Color

5. Stylex Product

Obair Tables

Contents

<hr/>		<hr/>	
COLORS, MATERIALS, AND FINISHES	5	OCCASIONAL TABLE	9
<hr/>		<hr/>	
STATEMENT OF LINE	6	MULTI-PURPOSE TABLE	14
<hr/>		<hr/>	
POWER OPTIONS	7	COUNTER/BAR TABLE	21
<hr/>		<hr/>	
HOW TO ORDER	8		

CLICK THE TITLES ABOVE TO NAVIGATE THROUGH THE DOCUMENT
PRODUCT HEADERS ON SUBSEQUENT PAGES LINK BACK TO THIS PAGE

Obair Tables

COLORS, MATERIALS, AND FINISHES

POWDER COATED PAINTED METAL FINISHES

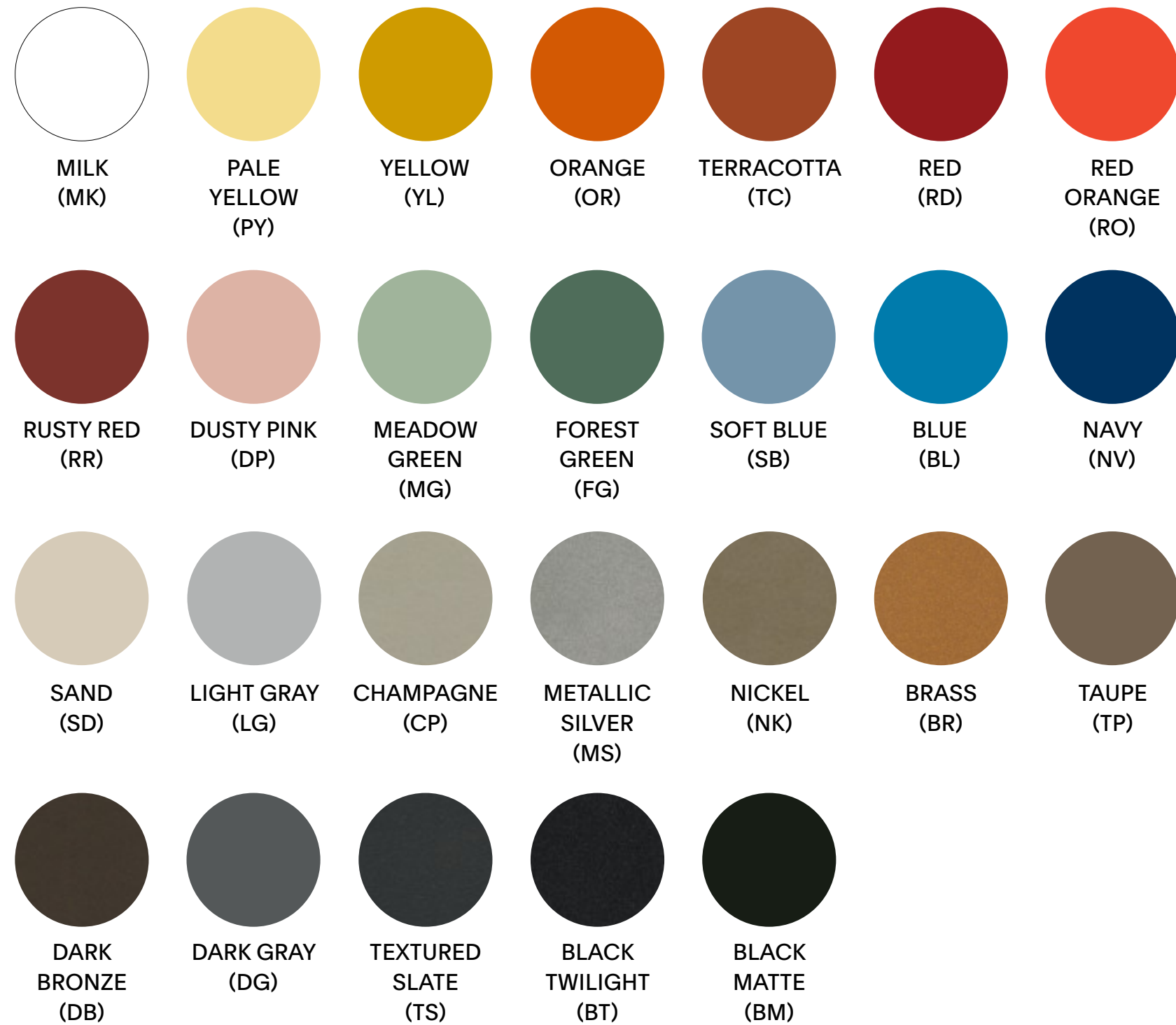

GRADE 1 LAMINATE FINISHES



GRADE 1 WOOD VENEER FINISHES



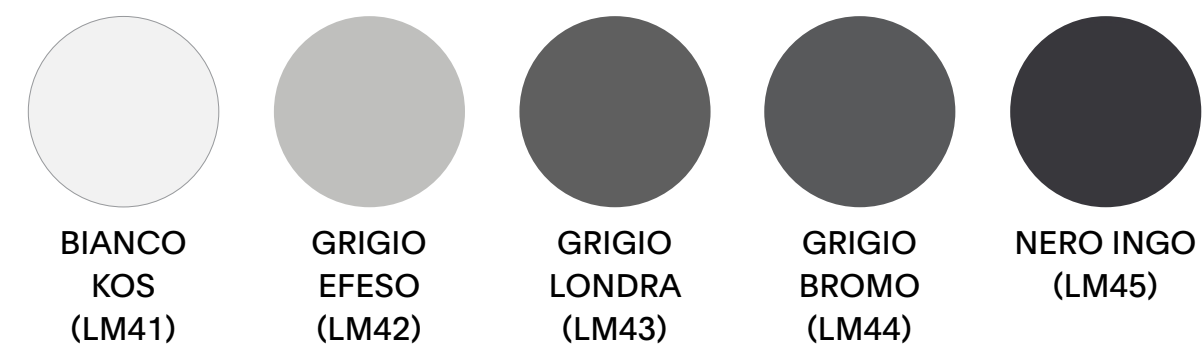

GRADE 2 LAMINATE FINISHES

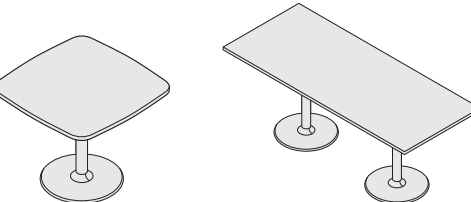
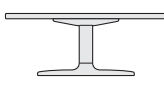

O Bair Tables

SPECIFICATION GUIDE: STATEMENT OF LINE

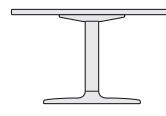
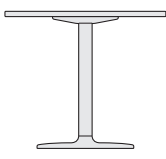
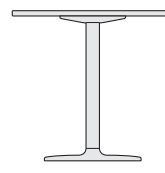
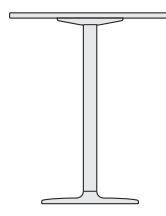
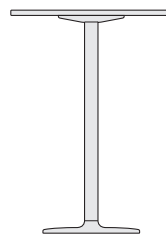
BASES	OCCASIONAL			MULTI-PURPOSE		COUNTER/BAR	
Table Heights For Single and Dual Bases 	Low Coffee 12" Height 	Coffee 15" Height 	End 18" Height 	Work 26" Height 	Dining 28.5" Height 	Counter 36" Height 	Bar 42" Height 

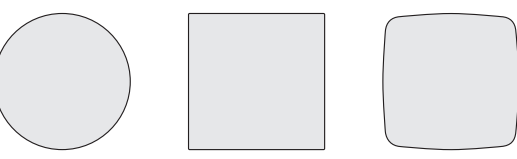
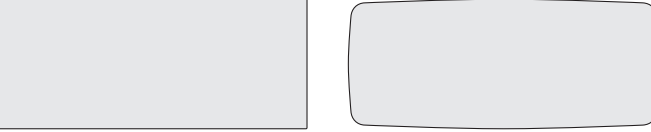
TOPS	ROUND TOPS		RECTANGLE TOPS				
Top Shapes/Sizes Round True Rectangle Soft Rectangle  	For Single Bases	Base Size	For Single Bases	Base Size	For Dual Bases*	Base Size	* Dual Base Occasional Tables are not offered in 84", 96" and 108" lengths
	21"	18"	21" x 21"	18"	30" x 56"	18"	
	24"	18"	24" x 24"	18"	30" x 60"	18"	
	27"	18"	27" x 27"	18"	30" x 72"	18"	
	30"	18"	30" x 30"	18"	30" x 84"	18"	
	36"	24"	36" x 36"	24"	30" x 96"	18"	
	42"	24"	42" x 42"	28"	30" x 108"	18"	
	48"	28"	48" x 48"	28"	36" x 56"	18"	
	54"	28"			36" x 60"	18"	
	60"	28"			36" x 72"	18"	
					36" x 84"	18"	
					36" x 96"	18" Multi-Purpose, 24" Counter/Bar	
					36" x 108"	24"	
					42" x 56"	24"	
					42" x 60"	24"	
					42" x 72"	24"	
					42" x 84"	24" Multi-Purpose, 28" Counter/Bar	
					42" x 96"	24" Multi-Purpose, 28" Counter/Bar	
					42" x 108"	24" Multi-Purpose, 28" Counter/Bar	
					48" x 84"	24" Multi-Purpose, 28" Counter/Bar	
					48" x 96"	24" Multi-Purpose, 28" Counter/Bar	
					48" x 108"	24" Multi-Purpose, 28" Counter/Bar	

Edge Details	Reverse Bevel 2	
Available on all Top Shapes	Straight Edge1 	Reverse Bevel 2 

GENERAL INFORMATION

Design

Stylex Design Team

Bases

O Bair bases are comprised of a top mounting plate, column and steel base. Base Diameter is 18", 24", or 28". Bases are available in Stylex's standard powder coat metal finishes. Bases can be flat packed or assembled for an additional charge.

Glides

Bases feature adjustable leveling glides, available in both hard and soft plastic. Hard plastic glides are recommended for carpet and soft plastic for flooring. Please be advised, sliding tables on hard surface flooring will result in scuffing or damage.

Cable Management

All bases offer cable management - See [page 7](#).

Top Edge Banding

Edge Banding is determined by top material finish.
 Laminate Grade 1: 2mm PVC Edgeband
 Laminate Grade 2: 1mm ABS Edgeband
 Wood Veneer: 3mm Wood Veneer Edgeband

Reverse Bevel Surface Finish is determined by top material and finish. Laminate is sealed with a coordinating finish. Wood Veneer "Natural" Finishes are clear sealed MDF. Non-"Natural" Finishes are stained and sealed to coordinate with veneer finish.

Custom Top Finishes

Non-standard laminates (LM99) will be quoted per color. Please contact Stylex customer service with the manufacturer's name and laminate color reference number.

For non-standard wood veneer (WV99), two 4" x 4" samples are required with, or before, order placement for each custom stain. A custom color match fee of \$450.00 will apply per color. Please contact customer service for details.

Use

Designed for indoor use only.

Performance Standards

Manufactured to comply with:
 ANSI/BIFMA X5.4 Lounge Seating Tests

Certifications

Greenguard Gold - Laminate
 Greenguard - Wood Veneer
 LEVEL® 2

Obair Tables

SPECIFICATION GUIDE: POWER OPTIONS

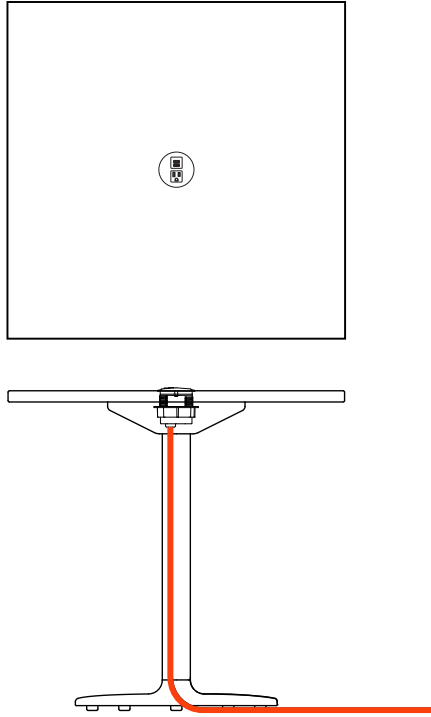
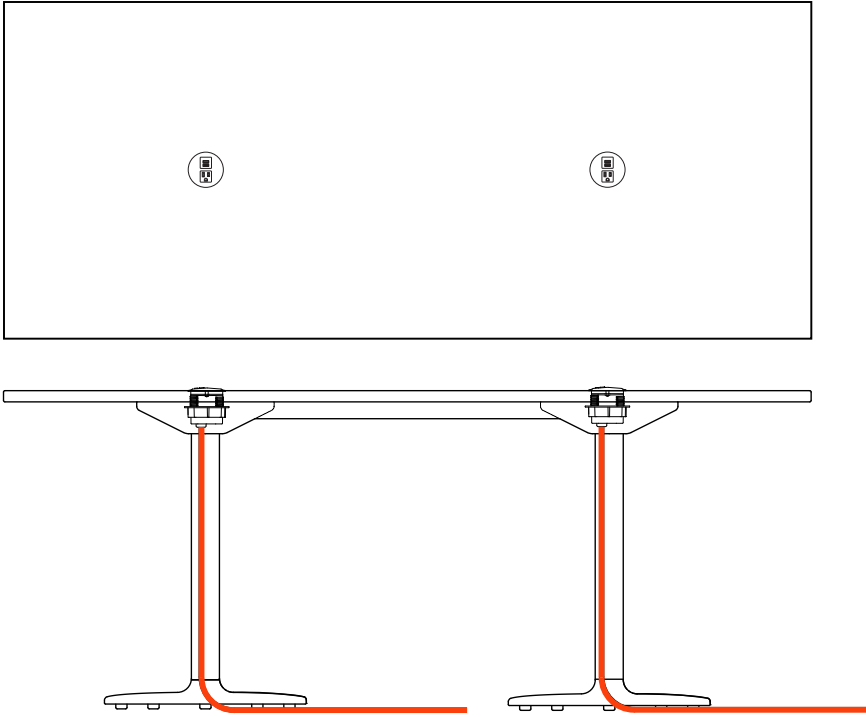
		CABLE LENGTH	MODEL	LIST PRICE	POSITIONS	GENERAL INFORMATION
Surface Mount Byrne Node Power Port 	One grounded AC outlet / 2 USB Powder coated cover plate Prop 65 Compliant Colors: Black, White	10 ft. Cord	S1	513	<div style="display: flex; justify-content: space-around;"> <div style="text-align: center;"> <p>Position 1</p>  </div> <div style="text-align: center;"> <p>Position 1 Position 2</p>  </div> </div>	Surface mount power is installed directly above the column. Cords are threaded through the column during set up and pass through a gap between the base and the glides. When ordering power for both column positions, plug type must be the same. The power model number is added to the end of the table top model number.
		10 ft. Hardwire Whip	SHW1	667		
		20 ft. Cord	S2	547		

To Order Select Below

<p>1. Mount</p> <div style="display: flex; align-items: center; margin-bottom: 5px;"> <div style="border: 1px solid black; border-radius: 50%; width: 20px; height: 20px; margin-right: 5px;"></div> <div style="margin-left: 5px;">Mount</div> </div> <hr/> <p>S SURFACE</p>	<p>2. Power Port Type</p> <div style="display: flex; align-items: center; margin-bottom: 5px;"> <div style="border: 1px solid black; border-radius: 50%; width: 20px; height: 20px; margin-right: 5px;"></div> <div style="margin-left: 5px;">Power Port</div> </div> <hr/> <table style="width: 100%; border-collapse: collapse;"> <tr> <td style="width: 5%; border-right: 1px solid black;">1</td> <td style="width: 75%;">BYRNE NODE SURFACE MOUNT WITH PLUG</td> <td style="width: 20%;">10FT CORD</td> </tr> <tr> <td style="border-right: 1px solid black;">HW1</td> <td>BYRNE NODE SURFACE MOUNT WITH HARD WIRE</td> <td>10FT HARDWIRE WHIP</td> </tr> <tr> <td style="border-right: 1px solid black;">2</td> <td>BYRNE NODE SURFACE MOUNT WITH PLUG</td> <td>20FT CORD</td> </tr> </table>	1	BYRNE NODE SURFACE MOUNT WITH PLUG	10FT CORD	HW1	BYRNE NODE SURFACE MOUNT WITH HARD WIRE	10FT HARDWIRE WHIP	2	BYRNE NODE SURFACE MOUNT WITH PLUG	20FT CORD	<p>3. Color</p> <div style="display: flex; align-items: center; margin-bottom: 5px;"> <div style="border: 1px solid black; border-radius: 50%; width: 20px; height: 20px; margin-right: 5px;"></div> <div style="margin-left: 5px;">Color</div> </div> <hr/> <table style="width: 100%; border-collapse: collapse;"> <tr> <td style="width: 5%; border-right: 1px solid black;">B</td> <td style="width: 95%;">BLACK</td> </tr> <tr> <td style="border-right: 1px solid black;">W</td> <td>WHITE</td> </tr> </table>	B	BLACK	W	WHITE	<p>4. Power Position</p> <div style="display: flex; align-items: center; margin-bottom: 5px;"> <div style="border: 1px solid black; border-radius: 50%; width: 20px; height: 20px; margin-right: 5px;"></div> <div style="margin-left: 5px;">Power Position</div> </div> <hr/> <table style="width: 100%; border-collapse: collapse;"> <tr> <td style="width: 5%; border-right: 1px solid black;">1</td> <td style="width: 95%;">POWER POSITION 1</td> </tr> <tr> <td style="border-right: 1px solid black;">2</td> <td>POWER POSITION 2</td> </tr> </table>	1	POWER POSITION 1	2	POWER POSITION 2
1	BYRNE NODE SURFACE MOUNT WITH PLUG	10FT CORD																		
HW1	BYRNE NODE SURFACE MOUNT WITH HARD WIRE	10FT HARDWIRE WHIP																		
2	BYRNE NODE SURFACE MOUNT WITH PLUG	20FT CORD																		
B	BLACK																			
W	WHITE																			
1	POWER POSITION 1																			
2	POWER POSITION 2																			

Obair Tables

SPECIFICATION GUIDE: HOW TO ORDER

MODEL CODE BREAKDOWN

Sample Model Code: **OBTR30108LM01ST1S1W1B15PGAMK**

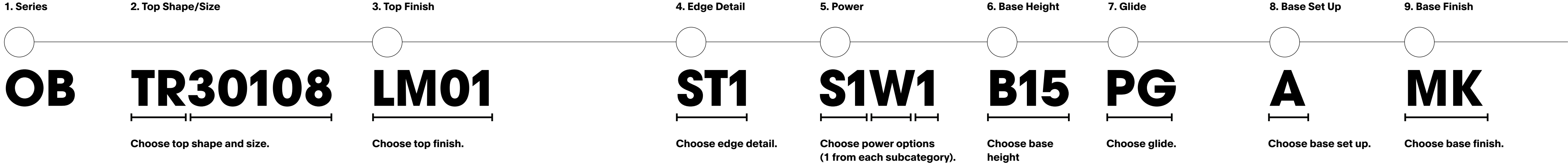

Series	Top Shape	Top Size	Top Finish		Top Edge Detail	Power	Base Height	Glide	Base Set Up	Base Finish
OB – OBAIR TABLES	RD – ROUND TR – TRUE RECTANGLE SR – SOFT RECTANGLE	21000 – 21" 24000 – 24" 27000 – 27" 30000 – 30" 36000 – 36" 42000 – 42" 48000 – 48" 54000 – 54" 60000 – 60" 21021 – 21" x 21" 24024 – 24" x 24" 27027 – 27" x 27" 30030 – 30" x 30" 36036 – 36" x 36" 42042 – 42" x 42" 48048 – 48" x 48" 30056 – 30" x 56" 30060 – 30" x 60" 30072 – 30" x 72" 30084 – 30" x 84" 30096 – 30" x 96" 30108 – 30" x 108" 36056 – 36" x 56" 36060 – 36" x 60" 36072 – 36" x 72" 36084 – 36" x 84" 36096 – 36" x 96" 36108 – 36" x 108" 42056 – 42" x 56" 42060 – 42" x 60" 42072 – 42" x 72" 42084 – 42" x 84" 42096 – 42" x 96" 42108 – 42" x 108" 48084 – 48" x 84" 48096 – 48" x 96" 48108 – 48" x 108"	Laminate Grade 1 LM01 – DESIGNER WHITE LM02 – ALABASTER LM03 – WALLABY LM04 – SHADOW LM05 – DOVE GREY LM06 – FASHION GREY LM07 – SLATE GREY LM08 – NORTH SEA LM09 – BLACK LM10 – FUSION MAPLE LM11 – MONTICELLO MAPLE LM12 – RIVER CHERRY LM13 – AMBER CHERRY LM14 – WALNUT HEIGHTS LM15 – MONTANA WALNUT LM16 – XANADU LM17 – ASIAN NIGHT Laminate Grade 2 LM41 – BIANCO KOS LM42 – GRIGIO EFESO LM43 – GRIGIO LONDRA LM44 – GRIGIO BROMO LM45 – NERO INGO	Veneer Grade 1 WV01 – LIGHT GREY WV02 – WARM GREY WV03 – OPAQUE BLACK WV04 – MEDIUM CHERRY WV05 – TONED ASH WV06 – NATURAL MAPLE WV41 – TONED RECON WALNUT WV42 – DARK TONED OAK WV43 – TONED WENGE WV44 – TONED OAK WV45 – TONED RECON OAK WV46 – NATURAL FLAT CUT WALNUT WV47 – NATURAL RIFT CUT WALNUT WV48 – NATURAL WHITE OAK WV49 – NATURAL RECON WHITE OAK Custom Top Finish LM99 – CUSTOM LAMINATE WV99 – CUSTOM WOOD VENEER	ST1 – STRAIGHT EDGE 1 RB2 – REVERSE BEVEL 2	Port Type S1 – BYRNE NODE SURFACE MOUNT WITH PLUG AND 10FT CORD SHW1 – BYRNE NODE SURFACE MOUNT WITH HARD WIRE AND 10FT WHIP S2 – BYRNE NODE SURFACE MOUNT WITH PLUG AND 20FT CORD Port Color B – BLACK W – WHITE Port Position 1 – POSITION 1 2 – POSITION 2	B12 – 12" B15 – 15" B18 – 18" B26 – 26" B29 – 28.5" B36 – 36" B42 – 42" Base diameter is automatically assigned during order entry.	PG – PLASTIC, CARPET SG – SOFT PLASTIC, FLOOR All glides are adjustable. Soft plastic glides are not designed for sliding tables.	F – FLAT PACKED A – ASSEMBLED	Powder Coat BL – BLUE BR – BRASS BM – BLACK MATTE BT – BLACK TWILIGHT CP – CHAMPAGNE DB – DARK BRONZE DG – DARK GRAY DP – DUSTY PINK FG – FOREST GREEN LG – LIGHT GRAY MG – MEADOW GREEN MK – MILK MS – METALLIC SILVER NK – NICKEL NV – NAVY OR – ORANGE PY – PALE YELLOW RD – RED RO – RED ORANGE RR – RUSTY RED SB – SOFT BLUE SD – SAND TC – TERRACOTTA TP – TAUPE TS – TEXTURED SLATE YL – YELLOW

Obair Tables

OCCASIONAL TABLE: ROUND

	SERIES	STYLE	TOP DIA.	BASE DIA.	Laminate Top Edge/Finish				Wood Veneer Top Edge/Finish			
					STRAIGHT EDGE 1		REVERSE BEVEL 2		STRAIGHT EDGE 1		REVERSE BEVEL 2	
					GRADE 1	GRADE 2	GRADE 1	GRADE 2	GRADE 1	GRADE 2	GRADE 1	GRADE 2
Occasional Table Round Top Single Base Height options: 12", 15", 18" Optional power through column Height adjustable glides Base ships flat packed or assembled	OB	RD	21	18	1,194	1,422	1,678	1,694	1,660	1,947		
			24	18	1,225	1,457	1,772	1,745	1,747	2,009		
			27	18	1,296	1,899	1,874	2,203	1,843	2,130		
			30	18	1,349	1,976	2,029	2,295	2,061	2,373		
			36	24	1,766	2,474	2,485	2,834	2,647	3,022		
			42	24	1,911	2,767	2,765	3,178	3,065	3,500		
			48	28	2,209	3,325	3,403	3,792	3,850	4,371		
			54	28	2,514	-	3,751	-	4,398	5,057		
			60	28	2,545	-	4,130	-	4,945	5,432		

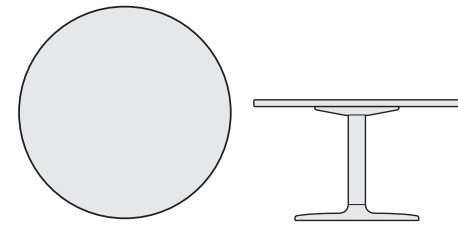

To Order Select Below

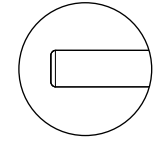
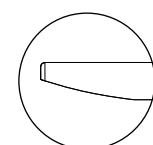
1. Series/Style	2. Top Size	3. Top Finish	4. Top Edge Detail	5. Power	6. Base Height	7. Glide	8. Base Set Up	9. Base Finish																																																																																																																																																																							
<p>Obair Table Round Top</p> <p>OBRD</p>	<p>Top Size</p> <table border="1"> <tr><td>21000</td><td>21 DIA.</td></tr> <tr><td>24000</td><td>24</td></tr> <tr><td>27000</td><td>27</td></tr> <tr><td>30000</td><td>30</td></tr> <tr><td>36000</td><td>36</td></tr> <tr><td>42000</td><td>42</td></tr> <tr><td>48000</td><td>48</td></tr> <tr><td>54000</td><td>54</td></tr> <tr><td>60000</td><td>60</td></tr> </table>	21000	21 DIA.	24000	24	27000	27	30000	30	36000	36	42000	42	48000	48	54000	54	60000	60	<p>Laminate - Grade 1</p> <table border="1"> <tr><td>LM01</td><td>DESIGNER WHITE</td></tr> <tr><td>LM02</td><td>ALABASTER</td></tr> <tr><td>LM03</td><td>WALLABY</td></tr> <tr><td>LM05</td><td>DOVE GREY</td></tr> <tr><td>LM06</td><td>FASHION GREY</td></tr> <tr><td>LM04</td><td>SHADOW</td></tr> <tr><td>LM08</td><td>NORTH SEA</td></tr> <tr><td>LM07</td><td>SLATE GREY</td></tr> <tr><td>LM09</td><td>BLACK</td></tr> <tr><td>LM10</td><td>FUSION MAPLE</td></tr> <tr><td>LM11</td><td>MONTICELLO MAPLE</td></tr> <tr><td>LM12</td><td>RIVER CHERRY</td></tr> <tr><td>LM13</td><td>AMBER CHERRY</td></tr> <tr><td>LM14</td><td>WALNUT HEIGHTS</td></tr> <tr><td>LM15</td><td>MONTANA WALNUT</td></tr> <tr><td>LM16</td><td>XANADU</td></tr> <tr><td>LM17</td><td>ASIAN NIGHT</td></tr> </table> <p>Laminate - Grade 2</p> <table border="1"> <tr><td>LM41</td><td>BIANCO KOS</td></tr> <tr><td>LM42</td><td>GRIGIO EFESO</td></tr> <tr><td>LM43</td><td>GRIGIO LONDRA</td></tr> <tr><td>LM44</td><td>GRIGIO BROMO</td></tr> <tr><td>LM45</td><td>NERO INGO</td></tr> </table> <p>Custom Finish</p> <table border="1"> <tr><td>LM99</td><td>CUSTOM LAMINATE</td></tr> <tr><td>WV99</td><td>CUSTOM WOOD</td></tr> </table> <p>See page 6 for custom laminate and custom wood details.</p>	LM01	DESIGNER WHITE	LM02	ALABASTER	LM03	WALLABY	LM05	DOVE GREY	LM06	FASHION GREY	LM04	SHADOW	LM08	NORTH SEA	LM07	SLATE GREY	LM09	BLACK	LM10	FUSION MAPLE	LM11	MONTICELLO MAPLE	LM12	RIVER CHERRY	LM13	AMBER CHERRY	LM14	WALNUT HEIGHTS	LM15	MONTANA WALNUT	LM16	XANADU	LM17	ASIAN NIGHT	LM41	BIANCO KOS	LM42	GRIGIO EFESO	LM43	GRIGIO LONDRA	LM44	GRIGIO BROMO	LM45	NERO INGO	LM99	CUSTOM LAMINATE	WV99	CUSTOM WOOD	<p>Wood Veneer - Grade 1</p> <table border="1"> <tr><td>WV05</td><td>TONED ASH</td></tr> <tr><td>WV06</td><td>NATURAL MAPLE</td></tr> <tr><td>WV49</td><td>NATURAL RECON WHITE OAK</td></tr> <tr><td>WV45</td><td>TONED RECON OAK</td></tr> <tr><td>WV44</td><td>TONED OAK</td></tr> <tr><td>WV48</td><td>NATURAL WHITE</td></tr> <tr><td>WV01</td><td>LIGHT GREY</td></tr> <tr><td>WV46</td><td>NATURAL FLAT CUT WALNUT</td></tr> <tr><td>WV47</td><td>NATURAL RIFT CUT WALNUT</td></tr> <tr><td>WV41</td><td>TONED RECON WALNUT</td></tr> <tr><td>WV04</td><td>MEDIUM CHERRY</td></tr> <tr><td>WV43</td><td>TONED WENGE</td></tr> <tr><td>WV02</td><td>WARM GREY</td></tr> <tr><td>WV42</td><td>DARK TONED OAK</td></tr> <tr><td>WV03</td><td>OPAQUE BLACK</td></tr> </table>	WV05	TONED ASH	WV06	NATURAL MAPLE	WV49	NATURAL RECON WHITE OAK	WV45	TONED RECON OAK	WV44	TONED OAK	WV48	NATURAL WHITE	WV01	LIGHT GREY	WV46	NATURAL FLAT CUT WALNUT	WV47	NATURAL RIFT CUT WALNUT	WV41	TONED RECON WALNUT	WV04	MEDIUM CHERRY	WV43	TONED WENGE	WV02	WARM GREY	WV42	DARK TONED OAK	WV03	OPAQUE BLACK	<p>Top Edge Detail</p> <table border="1"> <tr><td>ST1</td><td>STRAIGHT EDGE 1</td></tr> <tr><td>RB2</td><td>REVERSE BEVEL 2</td></tr> </table>   <p>Grade 1 laminate edge has a 2mm PVC edge. Grade 2 laminate has a 1mm ABS edge. Wood edge has a 3mm wood veneer edge.</p>	ST1	STRAIGHT EDGE 1	RB2	REVERSE BEVEL 2	<p>Please see page 7 for Obair Table power prices and model codes.</p>	<p>Base Height</p> <table border="1"> <tr><td>B12</td><td>12"</td></tr> <tr><td>B15</td><td>15"</td></tr> <tr><td>B18</td><td>18"</td></tr> </table> <p>Base diameter is automatically assigned during order entry.</p>	B12	12"	B15	15"	B18	18"	<p>Glide</p> <table border="1"> <tr><td>PG</td><td>PLASTIC, CARPET</td></tr> <tr><td>SG</td><td>SOFT PLASTIC, FLOOR</td></tr> </table> <p>All glides are adjustable. Soft plastic glides are not designed for sliding tables.</p>	PG	PLASTIC, CARPET	SG	SOFT PLASTIC, FLOOR	<p>Base Set Up</p> <table border="1"> <tr><td>F</td><td>FLAT PACKED</td></tr> <tr><td>A</td><td>ASSEMBLED +68</td></tr> </table>	F	FLAT PACKED	A	ASSEMBLED +68	<p>Standard Powder Coated Metal</p> <table border="1"> <tr><td>BL</td><td>BLUE</td><td>NK</td><td>NICKEL</td></tr> <tr><td>BM</td><td>BLACK MATTE</td><td>NV</td><td>NAVY</td></tr> <tr><td>BR</td><td>BRASS</td><td>OR</td><td>ORANGE</td></tr> <tr><td>BT</td><td>BLACK TWILIGHT</td><td>PY</td><td>PALE YELLOW</td></tr> <tr><td>CP</td><td>CHAMPAGNE</td><td>RD</td><td>RED</td></tr> <tr><td>DB</td><td>DARK BRONZE</td><td>RO</td><td>RED ORANGE</td></tr> <tr><td>DG</td><td>DARK GRAY</td><td>RR</td><td>RUSTY RED</td></tr> <tr><td>DP</td><td>DUSTY PINK</td><td>SB</td><td>SOFT BLUE</td></tr> <tr><td>FG</td><td>FOREST GREEN</td><td>SD</td><td>SAND</td></tr> <tr><td>LG</td><td>LIGHT GRAY</td><td>TC</td><td>TERRACOTTA</td></tr> <tr><td>MG</td><td>MEADOW GREEN</td><td>TP</td><td>TAUPE</td></tr> <tr><td>MK</td><td>MILK</td><td>TS</td><td>TEXTURED SLATE</td></tr> <tr><td>MS</td><td>METALLIC SILVER</td><td>YL</td><td>YELLOW</td></tr> </table>	BL	BLUE	NK	NICKEL	BM	BLACK MATTE	NV	NAVY	BR	BRASS	OR	ORANGE	BT	BLACK TWILIGHT	PY	PALE YELLOW	CP	CHAMPAGNE	RD	RED	DB	DARK BRONZE	RO	RED ORANGE	DG	DARK GRAY	RR	RUSTY RED	DP	DUSTY PINK	SB	SOFT BLUE	FG	FOREST GREEN	SD	SAND	LG	LIGHT GRAY	TC	TERRACOTTA	MG	MEADOW GREEN	TP	TAUPE	MK	MILK	TS	TEXTURED SLATE	MS	METALLIC SILVER	YL	YELLOW
21000	21 DIA.																																																																																																																																																																														
24000	24																																																																																																																																																																														
27000	27																																																																																																																																																																														
30000	30																																																																																																																																																																														
36000	36																																																																																																																																																																														
42000	42																																																																																																																																																																														
48000	48																																																																																																																																																																														
54000	54																																																																																																																																																																														
60000	60																																																																																																																																																																														
LM01	DESIGNER WHITE																																																																																																																																																																														
LM02	ALABASTER																																																																																																																																																																														
LM03	WALLABY																																																																																																																																																																														
LM05	DOVE GREY																																																																																																																																																																														
LM06	FASHION GREY																																																																																																																																																																														
LM04	SHADOW																																																																																																																																																																														
LM08	NORTH SEA																																																																																																																																																																														
LM07	SLATE GREY																																																																																																																																																																														
LM09	BLACK																																																																																																																																																																														
LM10	FUSION MAPLE																																																																																																																																																																														
LM11	MONTICELLO MAPLE																																																																																																																																																																														
LM12	RIVER CHERRY																																																																																																																																																																														
LM13	AMBER CHERRY																																																																																																																																																																														
LM14	WALNUT HEIGHTS																																																																																																																																																																														
LM15	MONTANA WALNUT																																																																																																																																																																														
LM16	XANADU																																																																																																																																																																														
LM17	ASIAN NIGHT																																																																																																																																																																														
LM41	BIANCO KOS																																																																																																																																																																														
LM42	GRIGIO EFESO																																																																																																																																																																														
LM43	GRIGIO LONDRA																																																																																																																																																																														
LM44	GRIGIO BROMO																																																																																																																																																																														
LM45	NERO INGO																																																																																																																																																																														
LM99	CUSTOM LAMINATE																																																																																																																																																																														
WV99	CUSTOM WOOD																																																																																																																																																																														
WV05	TONED ASH																																																																																																																																																																														
WV06	NATURAL MAPLE																																																																																																																																																																														
WV49	NATURAL RECON WHITE OAK																																																																																																																																																																														
WV45	TONED RECON OAK																																																																																																																																																																														
WV44	TONED OAK																																																																																																																																																																														
WV48	NATURAL WHITE																																																																																																																																																																														
WV01	LIGHT GREY																																																																																																																																																																														
WV46	NATURAL FLAT CUT WALNUT																																																																																																																																																																														
WV47	NATURAL RIFT CUT WALNUT																																																																																																																																																																														
WV41	TONED RECON WALNUT																																																																																																																																																																														
WV04	MEDIUM CHERRY																																																																																																																																																																														
WV43	TONED WENGE																																																																																																																																																																														
WV02	WARM GREY																																																																																																																																																																														
WV42	DARK TONED OAK																																																																																																																																																																														
WV03	OPAQUE BLACK																																																																																																																																																																														
ST1	STRAIGHT EDGE 1																																																																																																																																																																														
RB2	REVERSE BEVEL 2																																																																																																																																																																														
B12	12"																																																																																																																																																																														
B15	15"																																																																																																																																																																														
B18	18"																																																																																																																																																																														
PG	PLASTIC, CARPET																																																																																																																																																																														
SG	SOFT PLASTIC, FLOOR																																																																																																																																																																														
F	FLAT PACKED																																																																																																																																																																														
A	ASSEMBLED +68																																																																																																																																																																														
BL	BLUE	NK	NICKEL																																																																																																																																																																												
BM	BLACK MATTE	NV	NAVY																																																																																																																																																																												
BR	BRASS	OR	ORANGE																																																																																																																																																																												
BT	BLACK TWILIGHT	PY	PALE YELLOW																																																																																																																																																																												
CP	CHAMPAGNE	RD	RED																																																																																																																																																																												
DB	DARK BRONZE	RO	RED ORANGE																																																																																																																																																																												
DG	DARK GRAY	RR	RUSTY RED																																																																																																																																																																												
DP	DUSTY PINK	SB	SOFT BLUE																																																																																																																																																																												
FG	FOREST GREEN	SD	SAND																																																																																																																																																																												
LG	LIGHT GRAY	TC	TERRACOTTA																																																																																																																																																																												
MG	MEADOW GREEN	TP	TAUPE																																																																																																																																																																												
MK	MILK	TS	TEXTURED SLATE																																																																																																																																																																												
MS	METALLIC SILVER	YL	YELLOW																																																																																																																																																																												

Obair Tables

OCCASIONAL TABLE: TRUE RECTANGLE

	SERIES	STYLE	WIDTH	LENGTH	BASE DIA.	Laminate Top Edge/Finish		Wood Veneer Top Edge/Finish					
						STRAIGHT EDGE 1		REVERSE BEVEL 2		STRAIGHT EDGE 1		REVERSE BEVEL 2	
						GRADE 1	GRADE 2	GRADE 1	GRADE 2	GRADE 1	GRADE 2		
Occasional Table True Rectangle Top Single Base Height options: 12", 15", 18" Optional power through column Height adjustable glides Base ships flat packed or assembled	OB	TR	21	21	18	1,199	1,416	1,660	1,688	1,679	1,776		
			24	24	18	1,259	1,525	1,763	1,807	1,765	1,930		
			27	27	18	1,305	1,940	1,874	2,244	1,913	2,103		
			24	30	18	1,304	1,642	1,870	1,946	1,871	2,103		
			30	30	18	1,362	1,992	1,996	2,310	1,992	2,304		
			36	36	24	1,785	2,731	2,477	3,096	2,587	2,961		
			42	42	28	2,218	3,181	3,065	3,586	3,310	3,754		
			48	48	28	2,242	3,355	3,439	3,823	3,833	4,379		

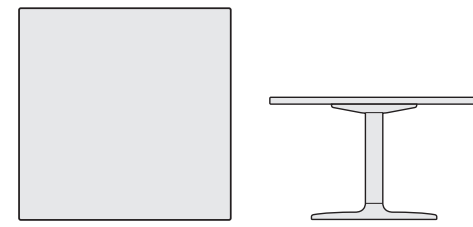

To Order Select Below

1. Series/Style	2. Top Size	3. Top Finish	4. Top Edge Detail	5. Power	6. Base Height	7. Glide	8. Base Set Up	9. Base Finish		
<p>OBTR</p> <p>Obair Table True Rectangle Top</p>	<p>Top Size</p> <p>21021 21W x 21L</p> <p>24024 24W x 24L</p> <p>27027 27W x 27L</p> <p>24030 24W x 30L</p> <p>30030 30W x 30L</p> <p>36036 36W x 36L</p> <p>42042 42W x 42L</p> <p>48048 48W x 48L</p>	<p>Laminate - Grade 1</p> <p>LM01 DESIGNER WHITE</p> <p>LM02 ALABASTER</p> <p>LM03 WALLABY</p> <p>LM05 DOVE GREY</p> <p>LM06 FASHION GREY</p> <p>LM04 SHADOW</p> <p>LM08 NORTH SEA</p> <p>LM07 SLATE GREY</p> <p>LM09 BLACK</p> <p>LM10 FUSION MAPLE</p> <p>LM11 MONTICELLO MAPLE</p> <p>LM12 RIVER CHERRY</p> <p>LM13 AMBER CHERRY</p> <p>LM14 WALNUT HEIGHTS</p> <p>LM15 MONTANA WALNUT</p> <p>LM16 XANADU</p> <p>LM17 ASIAN NIGHT</p>	<p>Laminate - Grade 2</p> <p>LM41 BIANCO KOS</p> <p>LM42 GRIGIO EFESO</p> <p>LM43 GRIGIO LONDRA</p> <p>LM44 GRIGIO BROMO</p> <p>LM45 NERO INGO</p> <p>Custom Finish</p> <p>LM99 CUSTOM LAMINATE</p> <p>WV99 CUSTOM WOOD</p> <p>See page 6 for custom laminate and custom wood details.</p>	<p>Wood Veneer - Grade 1</p> <p>WV05 TONED ASH</p> <p>WV06 NATURAL MAPLE</p> <p>WV49 NATURAL RECON WHITE OAK</p> <p>WV45 TONED RECON OAK</p> <p>WV44 TONED OAK</p> <p>WV48 NATURAL WHITE</p> <p>WV01 LIGHT GREY</p> <p>WV46 NATURAL FLAT CUT WALNUT</p> <p>WV47 NATURAL RIFT CUT WALNUT</p> <p>WV41 TONED RECON WALNUT</p> <p>WV04 MEDIUM CHERRY</p> <p>WV43 TONED WENGE</p> <p>WV02 WARM GREY</p> <p>WV42 DARK TONED OAK</p> <p>WV03 OPAQUE BLACK</p>	<p>Top Edge Detail</p> <p>ST1 STRAIGHT EDGE 1</p> <p>RB2 REVERSE BEVEL 2</p> <p>ST1</p> <p>RB2</p> <p>Grade 1 laminate edge has a 2mm PVC edge. Grade 2 laminate has a 1mm ABS edge. Wood edge has a 3mm wood veneer edge.</p>	<p>Power</p> <p>Please see page 7 for Obair Table power prices and model codes.</p>	<p>Base Height</p> <p>B12 12"</p> <p>B15 15"</p> <p>B18 18"</p> <p>Base diameter is automatically assigned during order entry.</p>	<p>Glide</p> <p>PLASTIC, PG CARPET</p> <p>SOFT PLASTIC, SG FLOOR</p> <p>All glides are adjustable. Soft plastic glides are not designed for sliding tables.</p>	<p>Base Set Up</p> <p>F PACKED</p> <p>ASSEMBLED A +68</p>	<p>Standard Powder Coated Metal</p> <p>BL BLUE</p> <p>NK NICKEL</p> <p>BM BLACK MATTE</p> <p>NV NAVY</p> <p>BR BRASS</p> <p>OR ORANGE</p> <p>BT BLACK TWILIGHT</p> <p>PY PALE YELLOW</p> <p>CP CHAMPAGNE</p> <p>RD RED</p> <p>DB DARK BRONZE</p> <p>RO RED ORANGE</p> <p>DG DARK GRAY</p> <p>RR RUSTY RED</p> <p>DP DUSTY PINK</p> <p>SB SOFT BLUE</p> <p>FG FOREST GREEN</p> <p>SD SAND</p> <p>LG LIGHT GRAY</p> <p>TC TERRACOTTA</p> <p>MG MEADOW GREEN</p> <p>TP TAUPE</p> <p>MK MILK</p> <p>TS TEXTURED SLATE</p> <p>MS METALLIC SILVER</p> <p>YL YELLOW</p>

Obair Tables

OCCASIONAL TABLE: SOFT RECTANGLE

	SERIES	STYLE	WIDTH	LENGTH	BASE DIA.	Laminate Top Edge/Finish				Wood Veneer Top Edge/Finish			
						STRAIGHT EDGE 1		REVERSE BEVEL 2		STRAIGHT EDGE 1		REVERSE BEVEL 2	
						GRADE 1	GRADE 2	GRADE 1	GRADE 2	GRADE 1	GRADE 2	GRADE 1	GRADE 2
Occasional Table Soft Rectangle Top Single Base Height options: 12", 15", 18" Optional power through column Height adjustable glides Base ships flat packed or assembled	OB	SR	21	21	18	1,207	1,422	1,678	1,704	1,574	1,808		
			24	24	18	1,275	1,514	1,772	1,818	1,704	1,965		
			27	27	18	1,324	1,910	1,874	2,244	1,843	2,130		
			24	30	18	1,321	1,622	1,870	1,946	1,941	2,130		
			30	30	18	1,382	1,951	1,983	2,301	2,122	2,323		
			36	36	24	1,806	2,690	2,485	3,102	2,647	3,022		
			42	42	28	2,234	3,150	3,001	3,535	3,310	3,754		
			48	48	28	2,261	3,274	3,359	3,757	3,833	4,354		

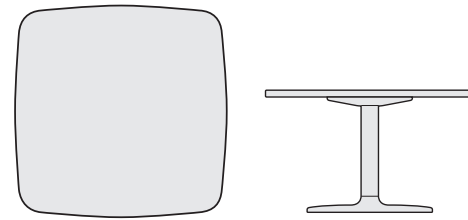

To Order Select Below

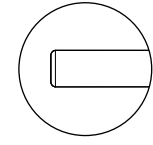
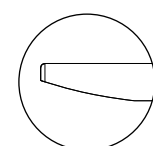
1. Series/Style	2. Top Size	3. Top Finish	4. Top Edge Detail	5. Power	6. Base Height	7. Glide	8. Base Set Up	9. Base Finish		
<p>Obair Table Soft Rectangle Top</p> <p>OBSR</p>	<p>Top Size</p> <p>21021 21W x 21L</p> <p>24024 24W x 24L</p> <p>27027 27W x 27L</p> <p>24030 24W x 30L</p> <p>30030 30W x 30L</p> <p>36036 36W x 36L</p> <p>42042 42W x 42L</p> <p>48048 48W x 48L</p>	<p>Laminate - Grade 1</p> <p>LM01 DESIGNER WHITE</p> <p>LM02 ALABASTER</p> <p>LM03 WALLABY</p> <p>LM05 DOVE GREY</p> <p>LM06 FASHION GREY</p> <p>LM04 SHADOW</p> <p>LM08 NORTH SEA</p> <p>LM07 SLATE GREY</p> <p>LM09 BLACK</p> <p>LM10 FUSION MAPLE</p> <p>LM11 MONTICELLO MAPLE</p> <p>LM12 RIVER CHERRY</p> <p>LM13 AMBER CHERRY</p> <p>LM14 WALNUT HEIGHTS</p> <p>LM15 MONTANA WALNUT</p> <p>LM16 XANADU</p> <p>LM17 ASIAN NIGHT</p>	<p>Laminate - Grade 2</p> <p>LM41 BIANCO KOS</p> <p>LM42 GRIGIO EFESO</p> <p>LM43 GRIGIO LONDRA</p> <p>LM44 GRIGIO BROMO</p> <p>LM45 NERO INGO</p> <p>Custom Finish</p> <p>LM99 CUSTOM LAMINATE</p> <p>WV99 CUSTOM WOOD</p> <p>See page 6 for custom laminate and custom wood details.</p>	<p>Wood Veneer - Grade 1</p> <p>WV05 TONED ASH</p> <p>WV06 NATURAL MAPLE</p> <p>WV49 NATURAL RECON WHITE OAK</p> <p>WV45 TONED RECON OAK</p> <p>WV44 TONED OAK</p> <p>WV48 NATURAL WHITE</p> <p>WV01 LIGHT GREY</p> <p>WV46 NATURAL FLAT CUT WALNUT</p> <p>WV47 NATURAL RIFT CUT WALNUT</p> <p>WV41 TONED RECON WALNUT</p> <p>WV04 MEDIUM CHERRY</p> <p>WV43 TONED WENGE</p> <p>WV02 WARM GREY</p> <p>WV42 DARK TONED OAK</p> <p>WV03 OPAQUE BLACK</p>	<p>Top Edge Detail</p> <p>ST1 STRAIGHT EDGE 1</p> <p>RB2 REVERSE BEVEL 2</p> <p> ST1</p> <p> RB2</p> <p>Grade 1 laminate edge has a 2mm PVC edge. Grade 2 laminate has a 1mm ABS edge. Wood edge has a 3mm wood veneer edge.</p>	<p>Power</p> <p>Please see page 7 for Obair Table power prices and model codes.</p>	<p>Base Height</p> <p>B12 12"</p> <p>B15 15"</p> <p>B18 18"</p> <p>Base diameter is automatically assigned during order entry.</p>	<p>Glide</p> <p>PLASTIC, PG CARPET</p> <p>SOFT PLASTIC, SG FLOOR</p> <p>All glides are adjustable. Soft plastic glides are not designed for sliding tables.</p>	<p>Base Set Up</p> <p>F PACKED</p> <p>A ASSEMBLED +68</p>	<p>Standard Powder Coated Metal</p> <p>BL BLUE</p> <p>NK NICKEL</p> <p>BM BLACK MATTE</p> <p>NV NAVY</p> <p>BR BRASS</p> <p>OR ORANGE</p> <p>BT BLACK TWILIGHT</p> <p>PY PALE YELLOW</p> <p>CP CHAMPAGNE</p> <p>RD RED</p> <p>DB DARK BRONZE</p> <p>RO RED ORANGE</p> <p>DG DARK GRAY</p> <p>RR RUSTY RED</p> <p>DP DUSTY PINK</p> <p>SB SOFT BLUE</p> <p>FG FOREST GREEN</p> <p>SD SAND</p> <p>LG LIGHT GRAY</p> <p>TC TERRACOTTA</p> <p>MG MEADOW GREEN</p> <p>TP TAUPE</p> <p>MK MILK</p> <p>TS TEXTURED SLATE</p> <p>MS METALLIC SILVER</p> <p>YL YELLOW</p>

Obair Tables

OCCASIONAL TABLE: TRUE RECTANGLE

	SERIES	STYLE	WIDTH	LENGTH	BASE DIA.	Laminate Top Edge/Finish		Wood Veneer Top Edge/Finish					
						STRAIGHT EDGE 1		REVERSE BEVEL 2		STRAIGHT EDGE 1		REVERSE BEVEL 2	
						GRADE 1	GRADE 2	GRADE 1	GRADE 2	GRADE 1	GRADE 2		
Occasional Table True Rectangle Top Dual Base Height options: 12", 15", 18" Optional power through column Height adjustable glides Base ships flat packed or assembled	OB	TR	30	56	18	2,659	3,892	3,513	4,293	3,773	4,200		
				60	18	2,675	4,214	3,600	4,626	3,924	4,368		
				72	18	2,840	4,629	3,887	5,081	4,377	4,881		
			36	56	18	2,805	4,107	3,722	4,544	4,070	4,546		
				60	18	2,822	4,148	3,823	4,600	4,247	4,749		
				72	18	3,003	4,696	4,119	5,194	4,741	5,307		
			42	56	24	3,289	4,632	4,377	5,099	4,838	5,368		
				60	24	3,302	4,815	4,489	5,308	5,041	5,597		
				72	24	3,477	5,253	4,852	5,798	5,630	6,265		

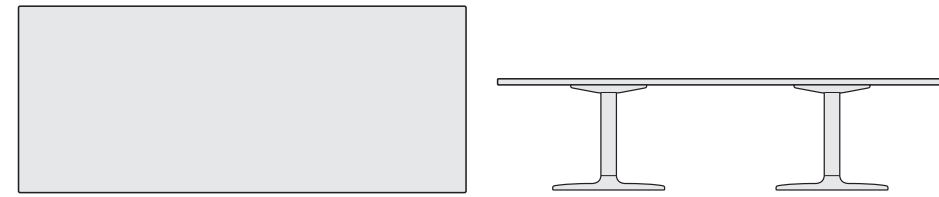

To Order Select Below

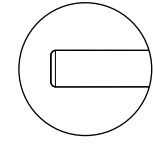
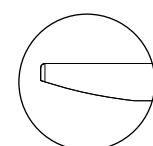
1. Series/Style	2. Top Size	3. Top Finish	4. Top Edge Detail	5. Power	6. Base Height	7. Glide	8. Base Set Up	9. Base Finish		
<p>OBTR</p> <p>Obair Table True Rectangle Top</p>	<p>Top Size</p> <p>30056 30W x 56L</p> <p>30060 30W x 60L</p> <p>30072 30W x 72L</p> <p>36056 36W x 56L</p> <p>36060 36W x 60L</p> <p>36072 36W x 72L</p> <p>42056 42W x 56L</p> <p>42060 42W x 60L</p> <p>42072 42W x 72L</p>	<p>Laminate - Grade 1</p> <p>LM01 DESIGNER WHITE</p> <p>LM02 ALABASTER</p> <p>LM03 WALLABY</p> <p>LM05 DOVE GREY</p> <p>LM06 FASHION GREY</p> <p>LM04 SHADOW</p> <p>LM08 NORTH SEA</p> <p>LM07 SLATE GREY</p> <p>LM09 BLACK</p> <p>LM10 FUSION MAPLE</p> <p>LM11 MONTICELLO MAPLE</p> <p>LM12 RIVER CHERRY</p> <p>LM13 AMBER CHERRY</p> <p>LM14 WALNUT HEIGHTS</p> <p>LM15 MONTANA WALNUT</p> <p>LM16 XANADU</p> <p>LM17 ASIAN NIGHT</p>	<p>Laminate - Grade 2</p> <p>LM41 BIANCO KOS</p> <p>LM42 GRIGIO EFESO</p> <p>LM43 GRIGIO LONDRA</p> <p>LM44 GRIGIO BROMO</p> <p>LM45 NERO INGO</p> <p>Custom Finish</p> <p>LM99 CUSTOM LAMINATE</p> <p>WV99 CUSTOM WOOD</p> <p>See page 6 for custom laminate and custom wood details.</p>	<p>Wood Veneer - Grade 1</p> <p>WV05 TONED ASH</p> <p>WV06 NATURAL MAPLE</p> <p>WV49 NATURAL RECON WHITE OAK</p> <p>WV45 TONED RECON OAK</p> <p>WV44 TONED OAK</p> <p>WV48 NATURAL WHITE</p> <p>WV01 LIGHT GREY</p> <p>WV46 NATURAL FLAT CUT WALNUT</p> <p>WV47 NATURAL RIFT CUT WALNUT</p> <p>WV41 TONED RECON WALNUT</p> <p>WV04 MEDIUM CHERRY</p> <p>WV43 TONED WENGE</p> <p>WV02 WARM GREY</p> <p>WV42 DARK TONED OAK</p> <p>WV03 OPAQUE BLACK</p>	<p>Top Edge Detail</p> <p>ST1 STRAIGHT EDGE 1</p> <p>RB2 REVERSE BEVEL 2</p> <p> ST1</p> <p> RB2</p> <p>Grade 1 laminate edge has a 2mm PVC edge. Grade 2 laminate has a 1mm ABS edge. Wood edge has a 3mm wood veneer edge.</p>	<p>Power</p> <p>Please see page 7 for Obair Table power prices and model codes.</p>	<p>Base Height</p> <p>B12 12"</p> <p>B15 15"</p> <p>B18 18"</p> <p>Base diameter is automatically assigned during order entry.</p>	<p>Glide</p> <p>PLASTIC, PG CARPET</p> <p>SOFT PLASTIC, SG FLOOR</p> <p>All glides are adjustable. Soft plastic glides are not designed for sliding tables.</p>	<p>Base Set Up</p> <p>F PACKED</p> <p>A ASSEMBLED +133</p>	<p>Standard Powder Coated Metal</p> <p>BL BLUE</p> <p>NK NICKEL</p> <p>BM BLACK MATTE</p> <p>NV NAVY</p> <p>BR BRASS</p> <p>OR ORANGE</p> <p>BT BLACK TWILIGHT</p> <p>PY PALE YELLOW</p> <p>CP CHAMPAGNE</p> <p>RD RED</p> <p>DB DARK BRONZE</p> <p>RO RED ORANGE</p> <p>DG DARK GRAY</p> <p>RR RUSTY RED</p> <p>DP DUSTY PINK</p> <p>SB SOFT BLUE</p> <p>FG FOREST GREEN</p> <p>SD SAND</p> <p>LG LIGHT GRAY</p> <p>TC TERRACOTTA</p> <p>MG MEADOW GREEN</p> <p>TP TAUPE</p> <p>MK MILK</p> <p>TS TEXTURED SLATE</p> <p>MS METALLIC SILVER</p> <p>YL YELLOW</p>

Obair Tables

OCCASIONAL TABLE: SOFT RECTANGLE

	SERIES	STYLE	WIDTH	LENGTH	BASE DIA.	Laminate Top Edge/Finish				Wood Veneer Top Edge/Finish	
						STRAIGHT EDGE 1		REVERSE BEVEL 2		STRAIGHT EDGE 1	REVERSE BEVEL 2
						GRADE 1	GRADE 2	GRADE 1	GRADE 2	GRADE 1	GRADE 1
Occasional Table Soft Rectangle Top Dual Base Height options: 12", 15", 18" Optional power through column Height adjustable glides Base ships flat packed or assembled	OB	SR	30	56	18	2,689	3,814	3,498	4,277	3,824	4,250
				60	18	2,703	4,117	3,576	4,605	3,966	4,418
				72	18	2,868	4,520	3,860	5,060	4,438	4,933
			36	56	18	2,833	4,010	3,684	4,514	4,112	4,590
				60	18	2,850	4,045	3,775	4,564	4,280	4,785
				72	18	3,032	4,510	4,004	5,096	4,724	5,288
			42	56	24	3,306	4,550	4,274	5,017	4,829	5,350
				60	24	3,320	4,722	4,420	5,251	5,067	5,623
				72	24	3,507	5,099	4,724	5,690	5,622	6,249

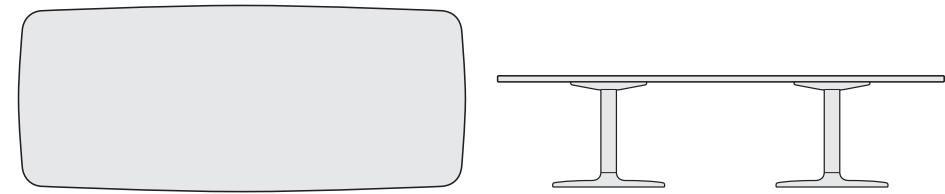

To Order Select Below

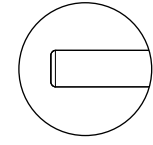
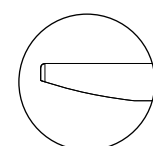
1. Series/Style	2. Top Size	3. Top Finish	4. Top Edge Detail	5. Power	6. Base Height	7. Glide	8. Base Set Up	9. Base Finish	
<p>Obair Table Soft Rectangle Top</p> <p>OBSR</p>	<p>Top Size</p> <p>30056 30W x 56L 30060 30W x 60L 30072 30W x 72L 36056 36W x 56L 36060 36W x 60L 36072 36W x 72L 42056 42W x 56L 42060 42W x 60L 42072 42W x 72L</p>	<p>Laminate - Grade 1</p> <p>LM01 DESIGNER WHITE LM02 ALABASTER LM03 WALLABY LM05 DOVE GREY LM06 FASHION GREY LM04 SHADOW LM08 NORTH SEA LM07 SLATE GREY LM09 BLACK LM10 FUSION MAPLE LM11 MONTICELLO MAPLE LM12 RIVER CHERRY LM13 AMBER CHERRY LM14 WALNUT HEIGHTS LM15 MONTANA WALNUT LM16 XANADU LM17 ASIAN NIGHT</p> <p>Laminate - Grade 2</p> <p>LM41 BIANCO KOS LM42 GRIGIO EFESO LM43 GRIGIO LONDRA LM44 GRIGIO BROMO LM45 NERO INGO</p> <p>Custom Finish</p> <p>LM99 CUSTOM LAMINATE WV99 CUSTOM WOOD</p> <p>See page 6 for custom laminate and custom wood details.</p>	<p>Wood Veneer - Grade 1</p> <p>WV05 TONED ASH WV06 NATURAL MAPLE WV49 NATURAL RECON WHITE OAK WV45 TONED RECON OAK WV44 TONED OAK WV48 NATURAL WHITE WV01 LIGHT GREY WV46 NATURAL FLAT CUT WALNUT WV47 NATURAL RIFT CUT WALNUT WV41 TONED RECON WALNUT WV04 MEDIUM CHERRY WV43 TONED WENGE WV02 WARM GREY WV42 DARK TONED OAK WV03 OPAQUE BLACK</p>	<p>Top Edge Detail</p> <p>ST1 STRAIGHT EDGE 1 RB2 REVERSE BEVEL 2</p> <p> ST1</p> <p> RB2</p> <p>Grade 1 laminate edge has a 2mm PVC edge. Grade 2 laminate has a 1mm ABS edge. Wood edge has a 3mm wood veneer edge.</p>	<p>Power</p> <p>Please see page 7 for Obair Table power prices and model codes.</p>	<p>Base Height</p> <p>B12 12" B15 15" B18 18"</p> <p>Base diameter is automatically assigned during order entry.</p>	<p>Glide</p> <p>PLASTIC, PG CARPET SOFT PLASTIC, SG FLOOR</p> <p>All glides are adjustable. Soft plastic glides are not designed for sliding tables.</p>	<p>Base Set Up</p> <p>F PACKED A ASSEMBLED +133</p>	<p>Standard Powder Coated Metal</p> <p>BL BLUE BM BLACK MATTE BR BRASS BT BLACK TWILIGHT CP CHAMPAGNE DB DARK BRONZE DG DARK GRAY DP DUSTY PINK FG FOREST GREEN LG LIGHT GRAY MG MEADOW GREEN MK MILK MS METALLIC SILVER</p> <p>NK NICKEL NV NAVY OR ORANGE PY PALE YELLOW RD RED RO RED ORANGE RR RUSTY RED SB SOFT BLUE SD SAND TC TERRACOTTA TP TAUPE TS TEXTURED SLATE YL YELLOW</p>

Obair Tables

MULTI-PURPOSE TABLE: ROUND

	SERIES	STYLE	TOP DIA.	BASE DIA.	Laminate Top Edge/Finish		Wood Veneer Top Edge/Finish		GRADE 1	GRADE 1
					STRAIGHT EDGE 1	REVERSE BEVEL 2	STRAIGHT EDGE 1	REVERSE BEVEL 2		
Multi-Purpose Table Round Top Single Base Height options: 26", 28.5" Optional power through column Height adjustable glides Base ships flat packed or assembled	OB	RD	21	18	1,232	1,460	1,716	1,732	1,698	1,985
			24	18	1,263	1,495	1,810	1,783	1,785	2,047
			27	18	1,334	1,937	1,912	2,241	1,881	2,168
			30	18	1,387	2,014	2,067	2,333	2,099	2,411
			36	24	1,791	2,499	2,510	2,859	2,672	3,047
			42	24	1,936	2,792	2,790	3,203	3,090	3,525
			48	28	2,217	3,333	3,411	3,800	3,858	4,379
			54	28	2,522	-	3,759	-	4,406	5,065
			60	28	2,553	-	4,138	-	4,953	5,440

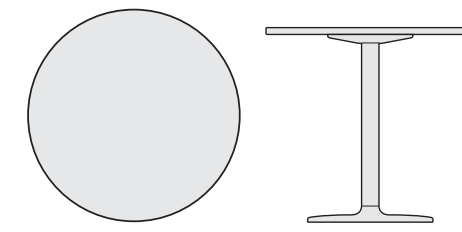

To Order Select Below

1. Series/Style	2. Top Size	3. Top Finish	4. Top Edge Detail	5. Power	6. Base Height	7. Glide	8. Base Set Up	9. Base Finish		
<p>Obair Table Round Top</p> <p>OBRD</p>	<p>Top Size</p> <p>21000 21 DIA.</p> <p>24000 24</p> <p>27000 27</p> <p>30000 30</p> <p>36000 36</p> <p>42000 42</p> <p>48000 48</p> <p>54000 54</p> <p>60000 60</p>	<p>Laminate - Grade 1</p> <p>LM01 DESIGNER WHITE</p> <p>LM02 ALABASTER</p> <p>LM03 WALLABY</p> <p>LM05 DOVE GREY</p> <p>LM06 FASHION GREY</p> <p>LM04 SHADOW</p> <p>LM08 NORTH SEA</p> <p>LM07 SLATE GREY</p> <p>LM09 BLACK</p> <p>LM10 FUSION MAPLE</p> <p>LM11 MONTICELLO MAPLE</p> <p>LM12 RIVER CHERRY</p> <p>LM13 AMBER CHERRY</p> <p>LM14 WALNUT HEIGHTS</p> <p>LM15 MONTANA WALNUT</p> <p>LM16 XANADU</p> <p>LM17 ASIAN NIGHT</p>	<p>Laminate - Grade 2</p> <p>LM41 BIANCO KOS</p> <p>LM42 GRIGIO EFESO</p> <p>LM43 GRIGIO LONDRA</p> <p>LM44 GRIGIO BROMO</p> <p>LM45 NERO INGO</p> <p>Custom Finish</p> <p>LM99 CUSTOM LAMINATE</p> <p>WV99 CUSTOM WOOD</p> <p>See page 6 for custom laminate and custom wood details.</p>	<p>Wood Veneer - Grade 1</p> <p>WV05 TONED ASH</p> <p>WV06 NATURAL MAPLE</p> <p>WV49 NATURAL RECON WHITE OAK</p> <p>WV45 TONED RECON OAK</p> <p>WV44 TONED OAK</p> <p>WV48 NATURAL WHITE</p> <p>WV01 LIGHT GREY</p> <p>WV46 NATURAL FLAT CUT WALNUT</p> <p>WV47 NATURAL RIFT CUT WALNUT</p> <p>WV41 TONED RECON WALNUT</p> <p>WV04 MEDIUM CHERRY</p> <p>WV43 TONED WENGE</p> <p>WV02 WARM GREY</p> <p>WV42 DARK TONED OAK</p> <p>WV03 OPAQUE BLACK</p>	<p>Top Edge Detail</p> <p>ST1 STRAIGHT EDGE 1</p> <p>RB2 REVERSE BEVEL 2</p> <p>ST1</p> <p>RB2</p> <p>Grade 1 laminate edge has a 2mm PVC edge. Grade 2 laminate has a 1mm ABS edge. Wood edge has a 3mm wood veneer edge.</p>	<p>Power</p> <p>Please see page 7 for Obair Table power prices and model codes.</p>	<p>Base Height</p> <p>B26 26"</p> <p>B29 28.5"</p> <p>Base diameter is automatically assigned during order entry.</p>	<p>Glide</p> <p>PLASTIC, PG CARPET</p> <p>SOFT PLASTIC, SG FLOOR</p> <p>All glides are adjustable. Soft plastic glides are not designed for sliding tables.</p>	<p>Base Set Up</p> <p>FLAT F PACKED</p> <p>ASSEMBLED A +133</p>	<p>Standard Powder Coated Metal</p> <p>BL BLUE</p> <p>NK NICKEL</p> <p>BM BLACK MATTE</p> <p>NV NAVY</p> <p>BR BRASS</p> <p>OR ORANGE</p> <p>BT BLACK TWILIGHT</p> <p>PY PALE YELLOW</p> <p>CP CHAMPAGNE</p> <p>RD RED</p> <p>DB DARK BRONZE</p> <p>RO RED ORANGE</p> <p>DG DARK GRAY</p> <p>RR RUSTY RED</p> <p>DP DUSTY PINK</p> <p>SB SOFT BLUE</p> <p>FG FOREST GREEN</p> <p>SD SAND</p> <p>LG LIGHT GRAY</p> <p>TC TERRACOTTA</p> <p>MG MEADOW GREEN</p> <p>TP TAUPE</p> <p>MK MILK</p> <p>TS TEXTURED SLATE</p> <p>MS METALLIC SILVER</p> <p>YL YELLOW</p>

Obair Tables

MULTI-PURPOSE TABLE: TRUE RECTANGLE

	SERIES	STYLE	WIDTH	LENGTH	BASE DIA.	Laminate Top Edge/Finish				Wood Veneer Top Edge/Finish	
						STRAIGHT EDGE 1		REVERSE BEVEL 2		STRAIGHT EDGE 1	REVERSE BEVEL 2
						GRADE 1	GRADE 2	GRADE 1	GRADE 2	GRADE 1	GRADE 1
Multi-Purpose Table True Rectangle Top Single Base Height options: 26", 28.5" Optional power through column Height adjustable glides Base ships flat packed or assembled	OB	TR	21	21	18	1,237	1,454	1,698	1,726	1,717	1,814
			24	24	18	1,297	1,563	1,801	1,845	1,803	1,968
			27	27	18	1,343	1,978	1,912	2,282	1,951	2,141
			24	30	18	1,342	1,680	1,908	1,984	1,909	2,141
			30	30	18	1,400	2,030	2,034	2,348	2,030	2,342
			36	36	24	1,810	2,756	2,502	3,121	2,612	2,986
			42	42	28	2,226	3,189	3,073	3,594	3,318	3,762
			48	48	28	2,250	3,363	3,447	3,831	3,841	4,387

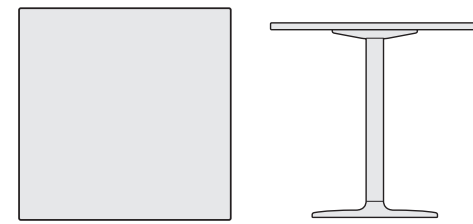

To Order Select Below

1. Series/Style	2. Top Size	3. Top Finish	4. Top Edge Detail	5. Power	6. Base Height	7. Glide	8. Base Set Up	9. Base Finish		
<p>OBTR</p> <p>Obair Table True Rectangle Top</p>	<p>21021 21W x 21L</p> <p>24024 24W x 24L</p> <p>27027 27W x 27L</p> <p>24030 24W x 30L</p> <p>30030 30W x 30L</p> <p>36036 36W x 36L</p> <p>42042 42W x 42L</p> <p>48048 48W x 48L</p>	<p>Laminate - Grade 1</p> <p>LM01 DESIGNER WHITE</p> <p>LM02 ALABASTER</p> <p>LM03 WALLABY</p> <p>LM05 DOVE GREY</p> <p>LM06 FASHION GREY</p> <p>LM04 SHADOW</p> <p>LM08 NORTH SEA</p> <p>LM07 SLATE GREY</p> <p>LM09 BLACK</p> <p>LM10 FUSION MAPLE</p> <p>LM11 MONTICELLO MAPLE</p> <p>LM12 RIVER CHERRY</p> <p>LM13 AMBER CHERRY</p> <p>LM14 WALNUT HEIGHTS</p> <p>LM15 MONTANA WALNUT</p> <p>LM16 XANADU</p> <p>LM17 ASIAN NIGHT</p>	<p>Laminate - Grade 2</p> <p>LM41 BIANCO KOS</p> <p>LM42 GRIGIO EFESO</p> <p>LM43 GRIGIO LONDRA</p> <p>LM44 GRIGIO BROMO</p> <p>LM45 NERO INGO</p> <p>Custom Finish</p> <p>LM99 CUSTOM LAMINATE</p> <p>WV99 CUSTOM WOOD</p> <p>See page 6 for custom laminate and custom wood details.</p>	<p>Wood Veneer - Grade 1</p> <p>WV05 TONED ASH</p> <p>WV06 NATURAL MAPLE</p> <p>WV49 NATURAL RECON WHITE OAK</p> <p>WV45 TONED RECON OAK</p> <p>WV44 TONED OAK</p> <p>WV48 NATURAL WHITE</p> <p>WV01 LIGHT GREY</p> <p>WV46 NATURAL FLAT CUT WALNUT</p> <p>WV47 NATURAL RIFT CUT WALNUT</p> <p>WV41 TONED RECON WALNUT</p> <p>WV04 MEDIUM CHERRY</p> <p>WV43 TONED WENGE</p> <p>WV02 WARM GREY</p> <p>WV42 DARK TONED OAK</p> <p>WV03 OPAQUE BLACK</p>	<p>Top Edge Detail</p> <p>ST1 STRAIGHT EDGE 1</p> <p>RB2 REVERSE BEVEL 2</p> <p>ST1</p> <p>RB2</p> <p>Grade 1 laminate edge has a 2mm PVC edge. Grade 2 laminate has a 1mm ABS edge. Wood edge has a 3mm wood veneer edge.</p>	<p>Power</p> <p>Please see page 7 for Obair Table power prices and model codes.</p>	<p>Base Height</p> <p>B26 26"</p> <p>B29 28.5"</p> <p>Base diameter is automatically assigned during order entry.</p>	<p>Glide</p> <p>PLASTIC, PG CARPET</p> <p>SOFT PLASTIC, SG FLOOR</p> <p>All glides are adjustable. Soft plastic glides are not designed for sliding tables.</p>	<p>Base Set Up</p> <p>F PACKED</p> <p>A ASSEMBLED +133</p>	<p>Standard Powder Coated Metal</p> <p>BL BLUE</p> <p>NK NICKEL</p> <p>BM BLACK MATTE</p> <p>NV NAVY</p> <p>BR BRASS</p> <p>OR ORANGE</p> <p>BT BLACK TWILIGHT</p> <p>PY PALE YELLOW</p> <p>CP CHAMPAGNE</p> <p>RD RED</p> <p>DB DARK BRONZE</p> <p>RO RED ORANGE</p> <p>DG DARK GRAY</p> <p>RR RUSTY RED</p> <p>DP DUSTY PINK</p> <p>SB SOFT BLUE</p> <p>FG FOREST GREEN</p> <p>SD SAND</p> <p>LG LIGHT GRAY</p> <p>TC TERRACOTTA</p> <p>MG MEADOW GREEN</p> <p>TP TAUPE</p> <p>MK MILK</p> <p>TS TEXTURED SLATE</p> <p>MS METALLIC SILVER</p> <p>YL YELLOW</p>

Obair Tables

MULTI-PURPOSE TABLE: SOFT RECTANGLE

	SERIES	STYLE	WIDTH	LENGTH	BASE DIA.	Laminate Top Edge/Finish		Wood Veneer Top Edge/Finish			
						STRAIGHT EDGE 1	REVERSE BEVEL 2	STRAIGHT EDGE 1	REVERSE BEVEL 2		
Multi-Purpose Table Soft Rectangle Top Single Base Height options: 26", 28.5" Optional power through column Height adjustable glides Base ships flat packed or assembled	OB	SR	21	21	18	1,245	1,460	1,716	1,742	1,612	1,846
			24	24	18	1,313	1,552	1,810	1,856	1,742	2,003
			27	27	18	1,362	1,948	1,912	2,282	1,881	2,168
			24	30	18	1,359	1,660	1,908	1,984	1,979	2,168
			30	30	18	1,420	1,989	2,021	2,339	2,160	2,361
			36	36	24	1,831	2,715	2,510	3,127	2,672	3,047
			42	42	28	2,242	3,158	3,009	3,543	3,318	3,762
			48	48	28	2,269	3,282	3,367	3,765	3,841	4,362

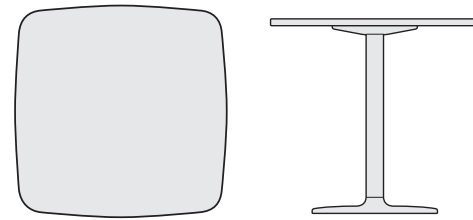

To Order Select Below

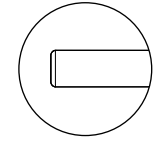
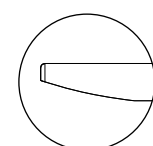
1. Series/Style	2. Top Size	3. Top Finish	4. Top Edge Detail	5. Power	6. Base Height	7. Glide	8. Base Set Up	9. Base Finish		
<p>Obair Table Soft Rectangle Top</p> <p>OBSR</p>	<p>Top Size</p> <p>21021 21W x 21L</p> <p>24024 24W x 24L</p> <p>27027 27W x 27L</p> <p>24030 24W x 30L</p> <p>30030 30W x 30L</p> <p>36036 36W x 36L</p> <p>42042 42W x 42L</p> <p>48048 48W x 48L</p>	<p>Laminate - Grade 1</p> <p>LM01 DESIGNER WHITE</p> <p>LM02 ALABASTER</p> <p>LM03 WALLABY</p> <p>LM05 DOVE GREY</p> <p>LM06 FASHION GREY</p> <p>LM04 SHADOW</p> <p>LM08 NORTH SEA</p> <p>LM07 SLATE GREY</p> <p>LM09 BLACK</p> <p>LM10 FUSION MAPLE</p> <p>LM11 MONTICELLO MAPLE</p> <p>LM12 RIVER CHERRY</p> <p>LM13 AMBER CHERRY</p> <p>LM14 WALNUT HEIGHTS</p> <p>LM15 MONTANA WALNUT</p> <p>LM16 XANADU</p> <p>LM17 ASIAN NIGHT</p>	<p>Laminate - Grade 2</p> <p>LM41 BIANCO KOS</p> <p>LM42 GRIGIO EFESO</p> <p>LM43 GRIGIO LONDRA</p> <p>LM44 GRIGIO BROMO</p> <p>LM45 NERO INGO</p> <p>Custom Finish</p> <p>LM99 CUSTOM LAMINATE</p> <p>WV99 CUSTOM WOOD</p> <p>See page 6 for custom laminate and custom wood details.</p>	<p>Wood Veneer - Grade 1</p> <p>WV05 TONED ASH</p> <p>WV06 NATURAL MAPLE</p> <p>WV49 NATURAL RECON WHITE OAK</p> <p>WV45 TONED RECON OAK</p> <p>WV44 TONED OAK</p> <p>WV48 NATURAL WHITE</p> <p>WV01 LIGHT GREY</p> <p>WV46 NATURAL FLAT CUT WALNUT</p> <p>WV47 NATURAL RIFT CUT WALNUT</p> <p>WV41 TONED RECON WALNUT</p> <p>WV04 MEDIUM CHERRY</p> <p>WV43 TONED WENGE</p> <p>WV02 WARM GREY</p> <p>WV42 DARK TONED OAK</p> <p>WV03 OPAQUE BLACK</p>	<p>Top Edge Detail</p> <p>ST1 STRAIGHT EDGE 1</p> <p>RB2 REVERSE BEVEL 2</p> <p> ST1</p> <p> RB2</p> <p>Grade 1 laminate edge has a 2mm PVC edge. Grade 2 laminate has a 1mm ABS edge. Wood edge has a 3mm wood veneer edge.</p>	<p>Power</p> <p>Please see page 7 for Obair Table power prices and model codes.</p>	<p>Base Height</p> <p>B26 26"</p> <p>B29 28.5"</p> <p>Base diameter is automatically assigned during order entry.</p>	<p>Glide</p> <p>PLASTIC, PG CARPET</p> <p>SOFT PLASTIC, SG FLOOR</p> <p>All glides are adjustable. Soft plastic glides are not designed for sliding tables.</p>	<p>Base Set Up</p> <p>F PACKED</p> <p>A ASSEMBLED +133</p>	<p>Standard Powder Coated Metal</p> <p>BL BLUE</p> <p>NK NICKEL</p> <p>BM BLACK MATTE</p> <p>NV NAVY</p> <p>BR BRASS</p> <p>OR ORANGE</p> <p>BT BLACK TWILIGHT</p> <p>PY PALE YELLOW</p> <p>CP CHAMPAGNE</p> <p>RD RED</p> <p>DB DARK BRONZE</p> <p>RO RED ORANGE</p> <p>DG DARK GRAY</p> <p>RR RUSTY RED</p> <p>DP DUSTY PINK</p> <p>SB SOFT BLUE</p> <p>FG FOREST GREEN</p> <p>SD SAND</p> <p>LG LIGHT GRAY</p> <p>TC TERRACOTTA</p> <p>MG MEADOW GREEN</p> <p>TP TAUPE</p> <p>MK MILK</p> <p>TS TEXTURED SLATE</p> <p>MS METALLIC SILVER</p> <p>YL YELLOW</p>

Obair Tables

MULTI-PURPOSE TABLE: TRUE RECTANGLE

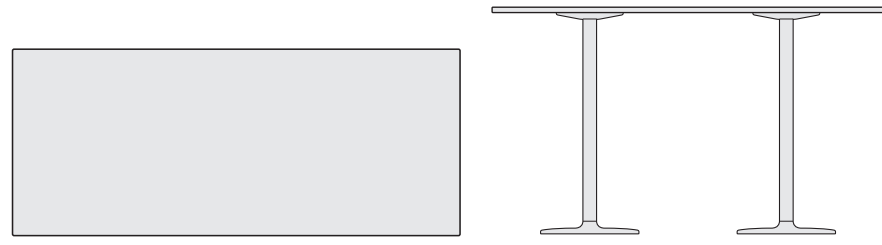
	SERIES	STYLE	WIDTH	LENGTH	BASE DIA.	Laminate Top Edge/Finish				Wood Veneer Top Edge/Finish	
						STRAIGHT EDGE 1		REVERSE BEVEL 2		STRAIGHT EDGE 1	REVERSE BEVEL 2
						GRADE 1	GRADE 2	GRADE 1	GRADE 2	GRADE 1	GRADE 1
Multi-Purpose Table True Rectangle Top Dual Base Height options: 26", 28.5" Optional power through column Height adjustable glides Base ships flat packed or assembled 	OB	TR	30	56	18	2,728	3,961	3,582	4,362	3,842	4,269
				60	18	2,744	4,283	3,669	4,695	3,993	4,437
				72	18	2,906	4,695	3,953	5,147	4,443	4,947
				84	18	2,922	5,087	4,212	5,575	4,850	5,405
				96	18	3,038	5,480	4,473	6,010	5,223	5,832
				108	18	3,245	5,878	4,739	6,444	5,655	6,317
			36	56	18	2,874	4,176	3,791	4,613	4,139	4,615
				60	18	2,891	4,217	3,892	4,669	4,316	4,818
				72	18	3,069	4,762	4,185	5,260	4,807	5,373
				84	18	3,427	5,190	4,511	5,730	5,311	5,945
				96	18	3,461	5,594	4,809	6,180	5,746	6,442
				108	24	4,172	6,424	5,528	7,051	6,691	7,456

To Order Select Below

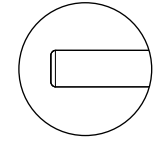
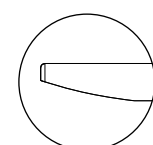
1. Series/Style	2. Top Size	3. Top Finish	4. Top Edge Detail	5. Power	6. Base Height	7. Glide	8. Base Set Up	9. Base Finish		
<p>OBTR</p> <p>Obair Table True Rectangle Top</p>	<p>Top Size</p> <p>30056 30W x 56L</p> <p>30060 30W x 60L</p> <p>30072 30W x 72L</p> <p>30084 30W x 84L</p> <p>30096 30W x 96L</p> <p>30108 30W x 108L</p> <p>36056 36W x 56L</p> <p>36060 36W x 60L</p> <p>36072 36W x 72L</p> <p>36084 36W x 84L</p> <p>36096 36W x 96L</p> <p>36108 36W x 108L</p>	<p>Laminate - Grade 1</p> <p>LM01 DESIGNER WHITE</p> <p>LM02 ALABASTER</p> <p>LM03 WALLABY</p> <p>LM05 DOVE GREY</p> <p>LM06 FASHION GREY</p> <p>LM04 SHADOW</p> <p>LM08 NORTH SEA</p> <p>LM07 SLATE GREY</p> <p>LM09 BLACK</p> <p>LM10 FUSION MAPLE</p> <p>LM11 MONTICELLO MAPLE</p> <p>LM12 RIVER CHERRY</p> <p>LM13 AMBER CHERRY</p> <p>LM14 WALNUT HEIGHTS</p> <p>LM15 MONTANA WALNUT</p> <p>LM16 XANADU</p> <p>LM17 ASIAN NIGHT</p>	<p>Laminate - Grade 2</p> <p>LM41 BIANCO KOS</p> <p>LM42 GRIGIO EFESO</p> <p>LM43 GRIGIO LONDRA</p> <p>LM44 GRIGIO BROMO</p> <p>LM45 NERO INGO</p> <p>Custom Finish</p> <p>LM99 CUSTOM LAMINATE</p> <p>WV99 CUSTOM WOOD</p> <p>See page 6 for custom laminate and custom wood details.</p>	<p>Wood Veneer - Grade 1</p> <p>WV05 TONED ASH</p> <p>WV06 NATURAL MAPLE</p> <p>WV49 NATURAL RECON WHITE OAK</p> <p>WV45 TONED RECON OAK</p> <p>WV44 TONED OAK</p> <p>WV48 NATURAL WHITE</p> <p>WV01 LIGHT GREY</p> <p>WV46 NATURAL FLAT CUT WALNUT</p> <p>WV47 NATURAL RIFT CUT WALNUT</p> <p>WV41 TONED RECON WALNUT</p> <p>WV04 MEDIUM CHERRY</p> <p>WV43 TONED WENGE</p> <p>WV02 WARM GREY</p> <p>WV42 DARK TONED OAK</p> <p>WV03 OPAQUE BLACK</p>	<p>Top Edge Detail</p> <p>ST1 STRAIGHT EDGE 1</p> <p>RB2 REVERSE BEVEL 2</p> <p> ST1</p> <p> RB2</p> <p>Grade 1 laminate edge has a 2mm PVC edge. Grade 2 laminate has a 1mm ABS edge. Wood edge has a 3mm wood veneer edge.</p>	<p>Power</p> <p>Please see page 7 for Obair Table power prices and model codes.</p>	<p>Base Height</p> <p>B26 26"</p> <p>B29 28.5"</p> <p>Base diameter is automatically assigned during order entry.</p>	<p>Glide</p> <p>PLASTIC, PG CARPET</p> <p>SOFT PLASTIC, SG FLOOR</p> <p>All glides are adjustable. Soft plastic glides are not designed for sliding tables.</p>	<p>Base Set Up</p> <p>F PACKED</p> <p>A ASSEMBLED +269</p>	<p>Standard Powder Coated Metal</p> <p>BL BLUE</p> <p>NK NICKEL</p> <p>BM BLACK MATTE</p> <p>NV NAVY</p> <p>BR BRASS</p> <p>OR ORANGE</p> <p>BT BLACK TWILIGHT</p> <p>PY PALE YELLOW</p> <p>CP CHAMPAGNE</p> <p>RD RED</p> <p>DB DARK BRONZE</p> <p>RO RED ORANGE</p> <p>DG DARK GRAY</p> <p>RR RUSTY RED</p> <p>DP DUSTY PINK</p> <p>SB SOFT BLUE</p> <p>FG FOREST GREEN</p> <p>SD SAND</p> <p>LG LIGHT GRAY</p> <p>TC TERRACOTTA</p> <p>MG MEADOW GREEN</p> <p>TP TAUPE</p> <p>MK MILK</p> <p>TS TEXTURED SLATE</p> <p>MS METALLIC SILVER</p> <p>YL YELLOW</p>

Obair Tables

MULTI-PURPOSE TABLE: TRUE RECTANGLE

	SERIES	STYLE	WIDTH	LENGTH	BASE DIA.	Laminate Top Edge/Finish				Wood Veneer Top Edge/Finish	
						STRAIGHT EDGE 1		REVERSE BEVEL 2		STRAIGHT EDGE 1	REVERSE BEVEL 2
						GRADE 1	GRADE 2	GRADE 1	GRADE 2	GRADE 1	GRADE 1
Multi-Purpose Table True Rectangle Top Dual Base Height options: 26", 28.5" Optional power through column Height adjustable glides Base ships flat packed or assembled	OB	TR	42	56	24	3,328	4,671	4,416	5,138	4,877	5,407
				60	24	3,342	4,855	4,529	5,348	5,081	5,637
				72	24	3,517	5,293	4,892	5,838	5,670	6,305
				84	24	3,860	5,711	5,226	6,302	6,216	6,922
				96	24	3,900	6,413	5,563	7,054	6,712	7,495
				108	24	4,177	6,547	5,904	7,246	7,281	8,133
			48	84	24	3,873	5,808	5,524	6,456	6,651	7,487
				96	24	3,899	6,546	5,898	7,255	7,209	8,138
				108	24	4,192	6,691	6,276	7,461	7,848	8,872

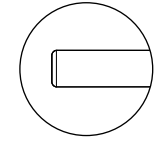
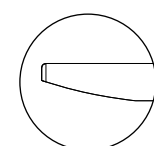

To Order Select Below

1. Series/Style	2. Top Size	3. Top Finish	4. Top Edge Detail	5. Power	6. Base Height	7. Glide	8. Base Set Up	9. Base Finish		
<p>OBTR</p> <p>Obair Table True Rectangle Top</p>	<p>Top Size</p> <p>42056 42W x 56L</p> <p>42060 42W x 60L</p> <p>42072 42W x 72L</p> <p>42084 42W x 84L</p> <p>42096 42W x 96L</p> <p>42108 42W x 108L</p> <p>48084 48W x 84L</p> <p>48096 48W x 96L</p> <p>48108 48W x 108L</p>	<p>Laminate - Grade 1</p> <p>LM01 DESIGNER WHITE</p> <p>LM02 ALABASTER</p> <p>LM03 WALLABY</p> <p>LM05 DOVE GREY</p> <p>LM06 FASHION GREY</p> <p>LM04 SHADOW</p> <p>LM08 NORTH SEA</p> <p>LM07 SLATE GREY</p> <p>LM09 BLACK</p> <p>LM10 FUSION MAPLE</p> <p>LM11 MONTICELLO MAPLE</p> <p>LM12 RIVER CHERRY</p> <p>LM13 AMBER CHERRY</p> <p>LM14 WALNUT HEIGHTS</p> <p>LM15 MONTANA WALNUT</p> <p>LM16 XANADU</p> <p>LM17 ASIAN NIGHT</p>	<p>Laminate - Grade 2</p> <p>LM41 BIANCO KOS</p> <p>LM42 GRIGIO EFESO</p> <p>LM43 GRIGIO LONDRA</p> <p>LM44 GRIGIO BROMO</p> <p>LM45 NERO INGO</p> <p>Custom Finish</p> <p>LM99 CUSTOM LAMINATE</p> <p>WV99 CUSTOM WOOD</p> <p>See page 6 for custom laminate and custom wood details.</p>	<p>Wood Veneer - Grade 1</p> <p>WV05 TONED ASH</p> <p>WV06 NATURAL MAPLE</p> <p>WV49 NATURAL RECON WHITE OAK</p> <p>WV45 TONED RECON OAK</p> <p>WV44 TONED OAK</p> <p>WV48 NATURAL WHITE</p> <p>WV01 LIGHT GREY</p> <p>WV46 NATURAL FLAT CUT WALNUT</p> <p>WV47 NATURAL RIFT CUT WALNUT</p> <p>WV41 TONED RECON WALNUT</p> <p>WV04 MEDIUM CHERRY</p> <p>WV43 TONED WENGE</p> <p>WV02 WARM GREY</p> <p>WV42 DARK TONED OAK</p> <p>WV03 OPAQUE BLACK</p>	<p>Top Edge Detail</p> <p>ST1 STRAIGHT EDGE 1</p> <p>RB2 REVERSE BEVEL 2</p> <p> ST1</p> <p> RB2</p> <p>Grade 1 laminate edge has a 2mm PVC edge. Grade 2 laminate has a 1mm ABS edge. Wood edge has a 3mm wood veneer edge.</p>	<p>Power</p> <p>Please see page 7 for Obair Table power prices and model codes.</p>	<p>Base Height</p> <p>B26 26"</p> <p>B29 28.5"</p> <p>Base diameter is automatically assigned during order entry.</p>	<p>Glide</p> <p>PLASTIC, PG CARPET</p> <p>SOFT PLASTIC, SG FLOOR</p> <p>All glides are adjustable. Soft plastic glides are not designed for sliding tables.</p>	<p>Base Set Up</p> <p>F PACKED</p> <p>A ASSEMBLED +269</p>	<p>Standard Powder Coated Metal</p> <p>BL BLUE</p> <p>NK NICKEL</p> <p>BM BLACK MATTE</p> <p>NV NAVY</p> <p>BR BRASS</p> <p>OR ORANGE</p> <p>BT BLACK TWILIGHT</p> <p>PY PALE YELLOW</p> <p>CP CHAMPAGNE</p> <p>RD RED</p> <p>DB DARK BRONZE</p> <p>RO RED ORANGE</p> <p>DG DARK GRAY</p> <p>RR RUSTY RED</p> <p>DP DUSTY PINK</p> <p>SB SOFT BLUE</p> <p>FG FOREST GREEN</p> <p>SD SAND</p> <p>LG LIGHT GRAY</p> <p>TC TERRACOTTA</p> <p>MG MEADOW GREEN</p> <p>TP TAUPE</p> <p>MK MILK</p> <p>TS TEXTURED SLATE</p> <p>MS METALLIC SILVER</p> <p>YL YELLOW</p>

Obair Tables

MULTI-PURPOSE TABLE: SOFT RECTANGLE

	SERIES	STYLE	WIDTH	LENGTH	BASE DIA.	Laminate Top Edge/Finish				Wood Veneer Top Edge/Finish			
						STRAIGHT EDGE 1		REVERSE BEVEL 2		STRAIGHT EDGE 1		REVERSE BEVEL 2	
						GRADE 1	GRADE 2	GRADE 1	GRADE 2	GRADE 1	GRADE 2	GRADE 1	GRADE 2
Multi-Purpose Table Soft Rectangle Top Dual Base Height options: 26", 28.5" Optional power through column Height adjustable glides Base ships flat packed or assembled	OB	SR	30	56	18	2,758	3,883	3,567	4,346	3,893	4,319		
				60	18	2,772	4,186	3,645	4,674	4,035	4,487		
				72	18	2,934	4,586	3,926	5,126	4,504	4,999		
				84	18	3,034	4,948	4,164	5,534	4,894	5,449		
				96	18	3,065	5,311	4,402	5,949	5,259	5,832		
				108	18	3,276	5,672	4,644	6,366	5,681	6,514		
			36	56	18	2,902	4,079	3,753	4,583	4,181	4,659		
				60	18	2,919	4,114	3,844	4,633	4,349	4,854		
				72	18	3,098	4,576	4,070	5,162	4,790	5,354		
				84	18	3,458	5,020	4,430	5,662	5,344	5,979		
				96	18	3,493	5,393	4,699	6,092	5,771	6,415		
				108	24	4,205	6,182	5,394	6,937	6,699	7,464		

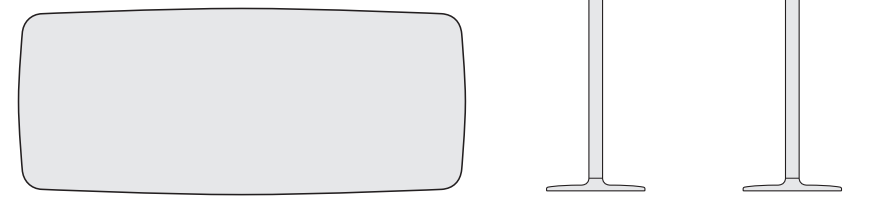

To Order Select Below

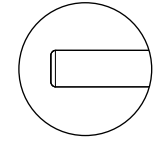
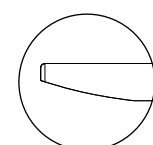
1. Series/Style	2. Top Size	3. Top Finish	4. Top Edge Detail	5. Power	6. Base Height	7. Glide	8. Base Set Up	9. Base Finish	
<p>Obair Table Soft Rectangle Top</p> <p>OBSR</p>	<p>Top Size</p> <p>30056 30W x 56L 30060 30W x 60L 30072 30W x 72L 30084 30W x 84L 30096 30W x 96L 30108 30W x 108L 36056 36W x 56L 36060 36W x 60L 36072 36W x 72L 36084 36W x 84L 36096 36W x 96L 36108 36W x 108L</p>	<p>Laminate - Grade 1</p> <p>LM01 DESIGNER WHITE LM02 ALABASTER LM03 WALLABY LM05 DOVE GREY LM06 FASHION GREY LM04 SHADOW LM08 NORTH SEA LM07 SLATE GREY LM09 BLACK LM10 FUSION MAPLE LM11 MONTICELLO MAPLE LM12 RIVER CHERRY LM13 AMBER CHERRY LM14 WALNUT HEIGHTS LM15 MONTANA WALNUT LM16 XANADU LM17 ASIAN NIGHT</p> <p>Laminate - Grade 2</p> <p>LM41 BIANCO KOS LM42 GRIGIO EFESO LM43 GRIGIO LONDRA LM44 GRIGIO BROMO LM45 NERO INGO</p> <p>Custom Finish</p> <p>LM99 CUSTOM LAMINATE WV99 CUSTOM WOOD</p> <p>See page 6 for custom laminate and custom wood details.</p>	<p>Wood Veneer - Grade 1</p> <p>WV05 TONED ASH WV06 NATURAL MAPLE WV49 NATURAL RECON WHITE OAK WV45 TONED RECON OAK WV44 TONED OAK WV48 NATURAL WHITE WV01 LIGHT GREY WV46 NATURAL FLAT CUT WALNUT WV47 NATURAL RIFT CUT WALNUT WV41 TONED RECON WALNUT WV04 MEDIUM CHERRY WV43 TONED WENGE WV02 WARM GREY WV42 DARK TONED OAK WV03 OPAQUE BLACK</p>	<p>Top Edge Detail</p> <p>ST1 STRAIGHT EDGE 1 RB2 REVERSE BEVEL 2</p> <p> ST1</p> <p> RB2</p> <p>Grade 1 laminate edge has a 2mm PVC edge. Grade 2 laminate has a 1mm ABS edge. Wood edge has a 3mm wood veneer edge.</p>	<p>Power</p> <p>Please see page 7 for Obair Table power prices and model codes.</p>	<p>Base Height</p> <p>B26 26" B29 28.5"</p> <p>Base diameter is automatically assigned during order entry.</p>	<p>Glide</p> <p>PLASTIC, PG CARPET SOFT PLASTIC, SG FLOOR</p> <p>All glides are adjustable. Soft plastic glides are not designed for sliding tables.</p>	<p>Base Set Up</p> <p>F PACKED A ASSEMBLED +269</p>	<p>Standard Powder Coated Metal</p> <p>BL BLUE BM BLACK MATTE BR BRASS BT BLACK TWILIGHT CP CHAMPAGNE DB DARK BRONZE DG DARK GRAY DP DUSTY PINK FG FOREST GREEN LG LIGHT GRAY MG MEADOW GREEN MK MILK MS METALLIC SILVER</p> <p>NK NICKEL NV NAVY OR ORANGE PY PALE YELLOW RD RED RO RED ORANGE RR RUSTY RED SB SOFT BLUE SD SAND TC TERRACOTTA TP TAUPE TS TEXTURED SLATE YL YELLOW</p>

Obair Tables

MULTI-PURPOSE TABLE: SOFT RECTANGLE

	SERIES	STYLE	WIDTH	LENGTH	BASE DIA.	Laminate Top Edge/Finish		Wood Veneer Top Edge/Finish			
						STRAIGHT EDGE 1	REVERSE BEVEL 2	STRAIGHT EDGE 1	REVERSE BEVEL 2		
Multi-Purpose Table Soft Rectangle Top Dual Base Height options: 26", 28.5" Optional power through column Height adjustable glides Base ships flat packed or assembled	OB	SR	42	56	24	GRADE 1	GRADE 2	GRADE 1	GRADE 2	GRADE 1	GRADE 1
				60	24	3,345	4,589	4,313	5,056	4,868	5,389
				72	24	3,360	4,762	4,460	5,291	5,107	5,663
				84	24	3,547	5,139	4,764	5,730	5,662	6,289
				96	24	3,891	5,515	5,066	6,173	6,192	6,896
				108	24	3,934	6,166	5,372	6,901	6,720	7,399
			48	84	24	4,218	6,275	5,726	7,097	7,272	8,133
				96	24	3,907	5,587	5,333	6,302	6,617	7,399
				108	24	3,934	6,269	5,717	7,101	7,147	8,069
					24	4,231	6,387	6,058	7,282	7,819	8,777

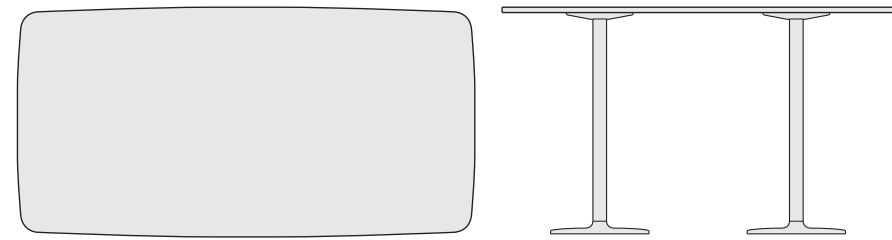

To Order Select Below

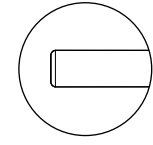
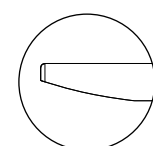
1. Series/Style	2. Top Size	3. Top Finish	4. Top Edge Detail	5. Power	6. Base Height	7. Glide	8. Base Set Up	9. Base Finish	
<p>Obair Table Soft Rectangle Top</p> <p>OBSR</p>	<p>Top Size</p> <p>42056 42W x 56L 42060 42W x 60L 42072 42W x 72L 42084 42W x 84L 42096 42W x 96L 42108 42W x 108L 48084 48W x 84L 48096 48W x 96L 48108 48W x 108L</p>	<p>Laminate - Grade 1</p> <p>LM01 DESIGNER WHITE LM02 ALABASTER LM03 WALLABY LM05 DOVE GREY LM06 FASHION GREY LM04 SHADOW LM08 NORTH SEA LM07 SLATE GREY LM09 BLACK LM10 FUSION MAPLE LM11 MONTICELLO MAPLE LM12 RIVER CHERRY LM13 AMBER CHERRY LM14 WALNUT HEIGHTS LM15 MONTANA WALNUT LM16 XANADU LM17 ASIAN NIGHT</p> <p>Laminate - Grade 2</p> <p>LM41 BIANCO KOS LM42 GRIGIO EFESO LM43 GRIGIO LONDRA LM44 GRIGIO BROMO LM45 NERO INGO</p> <p>Custom Finish</p> <p>LM99 CUSTOM LAMINATE WV99 CUSTOM WOOD</p> <p>See page 6 for custom laminate and custom wood details.</p>	<p>Wood Veneer - Grade 1</p> <p>WV05 TONED ASH WV06 NATURAL MAPLE WV49 NATURAL RECON WHITE OAK WV45 TONED RECON OAK WV44 TONED OAK WV48 NATURAL WHITE WV01 LIGHT GREY WV46 NATURAL FLAT CUT WALNUT WV47 NATURAL RIFT CUT WALNUT WV41 TONED RECON WALNUT WV04 MEDIUM CHERRY WV43 TONED WENGE WV02 WARM GREY WV42 DARK TONED OAK WV03 OPAQUE BLACK</p>	<p>Top Edge Detail</p> <p>ST1 STRAIGHT EDGE 1 RB2 REVERSE BEVEL 2</p> <p> ST1</p> <p> RB2</p> <p>Grade 1 laminate edge has a 2mm PVC edge. Grade 2 laminate has a 1mm ABS edge. Wood edge has a 3mm wood veneer edge.</p>	<p>Power</p> <p>Please see page 7 for Obair Table power prices and model codes.</p>	<p>Base Height</p> <p>B26 26" B29 28.5"</p> <p>Base diameter is automatically assigned during order entry.</p>	<p>Glide</p> <p>PLASTIC, PG CARPET SOFT PLASTIC, SG FLOOR</p> <p>All glides are adjustable. Soft plastic glides are not designed for sliding tables.</p>	<p>Base Set Up</p> <p>F PACKED A ASSEMBLED +269</p>	<p>Standard Powder Coated Metal</p> <p>BL BLUE BM BLACK MATTE BR BRASS BT BLACK TWILIGHT CP CHAMPAGNE DB DARK BRONZE DG DARK GRAY DP DUSTY PINK FG FOREST GREEN LG LIGHT GRAY MG MEADOW GREEN MK MILK MS METALLIC SILVER</p> <p>NK NICKEL NV NAVY OR ORANGE PY PALE YELLOW RD RED RO RED ORANGE RR RUSTY RED SB SOFT BLUE SD SAND TC TERRACOTTA TP TAUPE TS TEXTURED SLATE YL YELLOW</p>

Obair Tables

COUNTER/BAR TABLE: ROUND

	SERIES	STYLE	TOP DIA.	BASE DIA.	Laminate Top Edge/Finish		Wood Veneer Top Edge/Finish		Wood Veneer Top Edge/Finish	
					STRAIGHT EDGE 1	REVERSE BEVEL 2	STRAIGHT EDGE 1	REVERSE BEVEL 2		
Counter/Bar Table Round Top Single Base Height options: 36", 42" Optional power through column Height adjustable glides Base ships flat packed or assembled	OB	RD	21	18	1,327	1,555	1,811	1,827	1,793	2,080
			24	18	1,358	1,590	1,905	1,878	1,880	2,142
			27	18	1,429	2,032	2,007	2,336	1,976	2,263
			30	18	1,482	2,109	2,162	2,428	2,194	2,506
			36	24	1,897	2,605	2,616	2,965	2,778	3,153
			42	24	2,042	2,898	2,896	3,309	3,196	3,631
			48	28	2,341	3,457	3,535	3,924	3,982	4,503
			54	28	2,646	-	3,883	-	4,530	5,189
			60	28	2,677	-	4,262	-	5,077	5,564

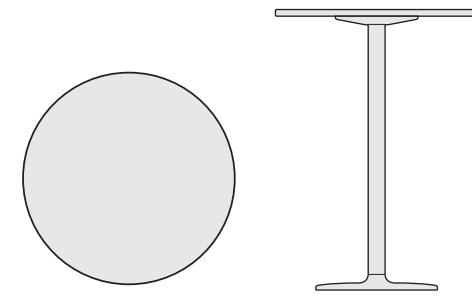

To Order Select Below

1. Series/Style	2. Top Size	3. Top Finish	4. Top Edge Detail	5. Power	6. Base Height	7. Glide	8. Base Set Up	9. Base Finish		
<p>OBRD</p> <p>Obair Table Round Top</p>	<p>Top Size</p> <p>21000 21 DIA.</p> <p>24000 24</p> <p>27000 27</p> <p>30000 30</p> <p>36000 36</p> <p>42000 42</p> <p>48000 48</p> <p>54000 54</p> <p>60000 60</p>	<p>Laminate - Grade 1</p> <p>LM01 DESIGNER WHITE</p> <p>LM02 ALABASTER</p> <p>LM03 WALLABY</p> <p>LM05 DOVE GREY</p> <p>LM06 FASHION GREY</p> <p>LM04 SHADOW</p> <p>LM08 NORTH SEA</p> <p>LM07 SLATE GREY</p> <p>LM09 BLACK</p> <p>LM10 FUSION MAPLE</p> <p>LM11 MONTICELLO MAPLE</p> <p>LM12 RIVER CHERRY</p> <p>LM13 AMBER CHERRY</p> <p>LM14 WALNUT HEIGHTS</p> <p>LM15 MONTANA WALNUT</p> <p>LM16 XANADU</p> <p>LM17 ASIAN NIGHT</p>	<p>Laminate - Grade 2</p> <p>LM41 BIANCO KOS</p> <p>LM42 GRIGIO EFESO</p> <p>LM43 GRIGIO LONDRA</p> <p>LM44 GRIGIO BROMO</p> <p>LM45 NERO INGO</p> <p>Custom Finish</p> <p>LM99 CUSTOM LAMINATE</p> <p>WV99 CUSTOM WOOD</p> <p>See page 6 for custom laminate and custom wood details.</p>	<p>Wood Veneer - Grade 1</p> <p>WV05 TONED ASH</p> <p>WV06 NATURAL MAPLE</p> <p>WV49 NATURAL RECON WHITE OAK</p> <p>WV45 TONED RECON OAK</p> <p>WV44 TONED OAK</p> <p>WV48 NATURAL WHITE</p> <p>WV01 LIGHT GREY</p> <p>WV46 NATURAL FLAT CUT WALNUT</p> <p>WV47 NATURAL RIFT CUT WALNUT</p> <p>WV41 TONED RECON WALNUT</p> <p>WV04 MEDIUM CHERRY</p> <p>WV43 TONED WENGE</p> <p>WV02 WARM GREY</p> <p>WV42 DARK TONED OAK</p> <p>WV03 OPAQUE BLACK</p>	<p>Top Edge Detail</p> <p>ST1 STRAIGHT EDGE 1</p> <p>RB2 REVERSE BEVEL 2</p> <p>ST1</p> <p>RB2</p> <p>Grade 1 laminate edge has a 2mm PVC edge. Grade 2 laminate has a 1mm ABS edge. Wood edge has a 3mm wood veneer edge.</p>	<p>Power</p> <p>Please see page 7 for Obair Table power prices and model codes.</p>	<p>Base Height</p> <p>B36 36"</p> <p>B42 42"</p> <p>Base diameter is automatically assigned during order entry.</p>	<p>Glide</p> <p>PLASTIC, PG CARPET</p> <p>SOFT PLASTIC, SG FLOOR</p> <p>All glides are adjustable. Soft plastic glides are not designed for sliding tables.</p>	<p>Base Set Up</p> <p>FLAT F PACKED</p> <p>ASSEMBLED A +202</p>	<p>Standard Powder Coated Metal</p> <p>BL BLUE</p> <p>NK NICKEL</p> <p>BM BLACK MATTE</p> <p>NV NAVY</p> <p>BR BRASS</p> <p>OR ORANGE</p> <p>BT BLACK TWILIGHT</p> <p>PY PALE YELLOW</p> <p>CP CHAMPAGNE</p> <p>RD RED</p> <p>DB DARK BRONZE</p> <p>RO RED ORANGE</p> <p>DG DARK GRAY</p> <p>RR RUSTY RED</p> <p>DP DUSTY PINK</p> <p>SB SOFT BLUE</p> <p>FG FOREST GREEN</p> <p>SD SAND</p> <p>LG LIGHT GRAY</p> <p>TC TERRACOTTA</p> <p>MG MEADOW GREEN</p> <p>TP TAUPE</p> <p>MK MILK</p> <p>TS TEXTURED SLATE</p> <p>MS METALLIC SILVER</p> <p>YL YELLOW</p>

Obair Tables

COUNTER/BAR TABLE: TRUE RECTANGLE

	SERIES	STYLE	WIDTH	LENGTH	BASE DIA.	Laminate Top Edge/Finish		Wood Veneer Top Edge/Finish			
						STRAIGHT EDGE 1	REVERSE BEVEL 2	STRAIGHT EDGE 1	REVERSE BEVEL 2		
Counter/Bar Table True Rectangle Top Single Base Height options: 36", 42" Optional power through column Height adjustable glides Base ships flat packed or assembled	OB	TR	21	21	18	1,332	1,549	1,793	1,821	1,812	1,909
			24	24	18	1,392	1,658	1,896	1,940	1,898	2,063
			27	27	18	1,438	2,073	2,007	2,377	2,046	2,236
			24	30	18	1,437	1,775	2,003	2,079	2,004	2,236
			30	30	18	1,495	2,125	2,129	2,443	2,125	2,437
			36	36	24	1,916	2,862	2,608	3,227	2,718	3,092
			42	42	28	2,350	3,313	3,197	3,718	3,442	3,886
			48	48	28	2,374	3,487	3,571	3,955	3,965	4,511

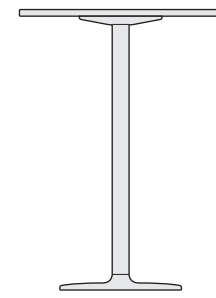

To Order Select Below

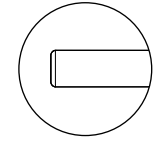
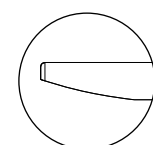
1. Series/Style	2. Top Size	3. Top Finish	4. Top Edge Detail	5. Power	6. Base Height	7. Glide	8. Base Set Up	9. Base Finish		
<p>OBTR</p> <p>Obair Table True Rectangle Top</p>	<p>21021 21W x 21L</p> <p>24024 24W x 24L</p> <p>27027 27W x 27L</p> <p>24030 24W x 30L</p> <p>30030 30W x 30L</p> <p>36036 36W x 36L</p> <p>42042 42W x 42L</p> <p>48048 48W x 48L</p>	<p>Laminate - Grade 1</p> <p>LM01 DESIGNER WHITE</p> <p>LM02 ALABASTER</p> <p>LM03 WALLABY</p> <p>LM05 DOVE GREY</p> <p>LM06 FASHION GREY</p> <p>LM04 SHADOW</p> <p>LM08 NORTH SEA</p> <p>LM07 SLATE GREY</p> <p>LM09 BLACK</p> <p>LM10 FUSION MAPLE</p> <p>LM11 MONTICELLO MAPLE</p> <p>LM12 RIVER CHERRY</p> <p>LM13 AMBER CHERRY</p> <p>LM14 WALNUT HEIGHTS</p> <p>LM15 MONTANA WALNUT</p> <p>LM16 XANADU</p> <p>LM17 ASIAN NIGHT</p>	<p>Laminate - Grade 2</p> <p>LM41 BIANCO KOS</p> <p>LM42 GRIGIO EFESO</p> <p>LM43 GRIGIO LONDRA</p> <p>LM44 GRIGIO BROMO</p> <p>LM45 NERO INGO</p> <p>Custom Finish</p> <p>LM99 CUSTOM LAMINATE</p> <p>WV99 CUSTOM WOOD</p> <p>See page 6 for custom laminate and custom wood details.</p>	<p>Wood Veneer - Grade 1</p> <p>WV05 TONED ASH</p> <p>WV06 NATURAL MAPLE</p> <p>WV49 NATURAL RECON WHITE OAK</p> <p>WV45 TONED RECON OAK</p> <p>WV44 TONED OAK</p> <p>WV48 NATURAL WHITE</p> <p>WV01 LIGHT GREY</p> <p>WV46 NATURAL FLAT CUT WALNUT</p> <p>WV47 NATURAL RIFT CUT WALNUT</p> <p>WV41 TONED RECON WALNUT</p> <p>WV04 MEDIUM CHERRY</p> <p>WV43 TONED WENGE</p> <p>WV02 WARM GREY</p> <p>WV42 DARK TONED OAK</p> <p>WV03 OPAQUE BLACK</p>	<p>Top Edge Detail</p> <p>ST1 STRAIGHT EDGE 1</p> <p>RB2 REVERSE BEVEL 2</p> <p> ST1</p> <p> RB2</p> <p>Grade 1 laminate edge has a 2mm PVC edge. Grade 2 laminate has a 1mm ABS edge. Wood edge has a 3mm wood veneer edge.</p>	<p>Power</p> <p>Please see page 7 for Obair Table power prices and model codes.</p>	<p>Base Height</p> <p>B36 36"</p> <p>B42 42"</p> <p>Base diameter is automatically assigned during order entry.</p>	<p>Glide</p> <p>PLASTIC, PG CARPET</p> <p>SOFT PLASTIC, SG FLOOR</p> <p>All glides are adjustable. Soft plastic glides are not designed for sliding tables.</p>	<p>Base Set Up</p> <p>FLAT PACKED</p> <p>ASSEMBLED A +202</p>	<p>Standard Powder Coated Metal</p> <p>BL BLUE</p> <p>NK NICKEL</p> <p>BM BLACK MATTE</p> <p>NV NAVY</p> <p>BR BRASS</p> <p>OR ORANGE</p> <p>BT BLACK TWILIGHT</p> <p>PY PALE YELLOW</p> <p>CP CHAMPAGNE</p> <p>RD RED</p> <p>DB DARK BRONZE</p> <p>RO RED ORANGE</p> <p>DG DARK GRAY</p> <p>RR RUSTY RED</p> <p>DP DUSTY PINK</p> <p>SB SOFT BLUE</p> <p>FG FOREST GREEN</p> <p>SD SAND</p> <p>LG LIGHT GRAY</p> <p>TC TERRACOTTA</p> <p>MG MEADOW GREEN</p> <p>TP TAUPE</p> <p>MK MILK</p> <p>TS TEXTURED SLATE</p> <p>MS METALLIC SILVER</p> <p>YL YELLOW</p>

Obair Tables

COUNTER/BAR TABLE: SOFT RECTANGLE

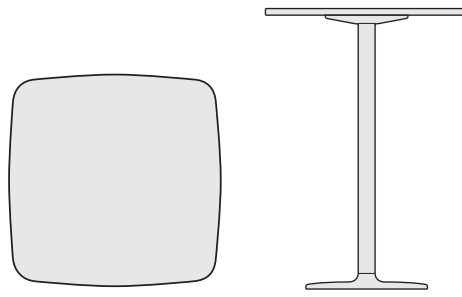
Counter/Bar Table Soft Rectangle Top Single Base	Height options: 36", 42" Optional power through column Height adjustable glides Base ships flat packed or assembled	SERIES	STYLE	WIDTH	LENGTH	BASE DIA.	Laminate Top Edge/Finish				Wood Veneer Top Edge/Finish	
							STRAIGHT EDGE 1		REVERSE BEVEL 2		STRAIGHT EDGE 1	REVERSE BEVEL 2
							GRADE 1	GRADE 2	GRADE 1	GRADE 2	GRADE 1	GRADE 1
		OB	SR	21	21	18	1,340	1,555	1,811	1,837	1,707	1,941
				24	24	18	1,408	1,647	1,905	1,951	1,837	2,098
				27	27	18	1,457	2,043	2,007	2,377	1,976	2,263
				24	30	18	1,454	1,755	2,003	2,079	2,074	2,263
				30	30	18	1,515	2,084	2,116	2,434	2,255	2,456
				36	36	24	1,937	2,821	2,616	3,233	2,778	3,153
				42	42	28	2,366	3,282	3,133	3,667	3,442	3,886
				48	48	28	2,393	3,406	3,491	3,889	3,965	4,486

To Order Select Below

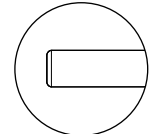
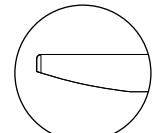
1. Series/Style	2. Top Size	3. Top Finish	4. Top Edge Detail	5. Power	6. Base Height	7. Glide	8. Base Set Up	9. Base Finish	
<p>Obair Table Soft Rectangle Top</p> <p>OBSR</p>	<p>Top Size</p> <p>21021 21W x 21L 24024 24W x 24L 27027 27W x 27L 24030 24W x 30L 30030 30W x 30L 36036 36W x 36L 42042 42W x 42L 48048 48W x 48L</p>	<p>Laminate - Grade 1</p> <p>LM01 DESIGNER WHITE LM02 ALABASTER LM03 WALLABY LM05 DOVE GREY LM06 FASHION GREY LM04 SHADOW LM08 NORTH SEA LM07 SLATE GREY LM09 BLACK LM10 FUSION MAPLE LM11 MONTICELLO MAPLE LM12 RIVER CHERRY LM13 AMBER CHERRY LM14 WALNUT HEIGHTS LM15 MONTANA WALNUT LM16 XANADU LM17 ASIAN NIGHT</p> <p>Laminate - Grade 2</p> <p>LM41 BIANCO KOS LM42 GRIGIO EFESO LM43 GRIGIO LONDRA LM44 GRIGIO BROMO LM45 NERO INGO</p> <p>Custom Finish</p> <p>LM99 CUSTOM LAMINATE WV99 CUSTOM WOOD</p> <p>See page 6 for custom laminate and custom wood details.</p>	<p>Wood Veneer - Grade 1</p> <p>WV05 TONED ASH WV06 NATURAL MAPLE WV49 NATURAL RECON WHITE OAK WV45 TONED RECON OAK WV44 TONED OAK WV48 NATURAL WHITE WV01 LIGHT GREY WV46 NATURAL FLAT CUT WALNUT WV47 NATURAL RIFT CUT WALNUT WV41 TONED RECON WALNUT WV04 MEDIUM CHERRY WV43 TONED WENGE WV02 WARM GREY WV42 DARK TONED OAK WV03 OPAQUE BLACK</p>	<p>Top Edge Detail</p> <p>ST1 STRAIGHT EDGE 1 RB2 REVERSE BEVEL 2</p> <p> ST1</p> <p> RB2</p> <p>Grade 1 laminate edge has a 2mm PVC edge. Grade 2 laminate has a 1mm ABS edge. Wood edge has a 3mm wood veneer edge.</p>	<p>Power</p> <p>Please see page 7 for Obair Table power prices and model codes.</p>	<p>Base Height</p> <p>B36 36" B42 42"</p> <p>Base diameter is automatically assigned during order entry.</p>	<p>Glide</p> <p>PLASTIC, PG CARPET SOFT PLASTIC, SG FLOOR</p> <p>All glides are adjustable. Soft plastic glides are not designed for sliding tables.</p>	<p>Base Set Up</p> <p>F PACKED A ASSEMBLED +202</p>	<p>Standard Powder Coated Metal</p> <p>BL BLUE BM BLACK MATTE BR BRASS BT BLACK TWILIGHT CP CHAMPAGNE DB DARK BRONZE DG DARK GRAY DP DUSTY PINK FG FOREST GREEN LG LIGHT GRAY MG MEADOW GREEN MK MILK MS METALLIC SILVER</p> <p>NK NICKEL NV NAVY OR ORANGE PY PALE YELLOW RD RED RO RED ORANGE RR RUSTY RED SB SOFT BLUE SD SAND TC TERRACOTTA TP TAUPE TS TEXTURED SLATE YL YELLOW</p>

Obair Tables

COUNTER/BAR TABLE: TRUE RECTANGLE

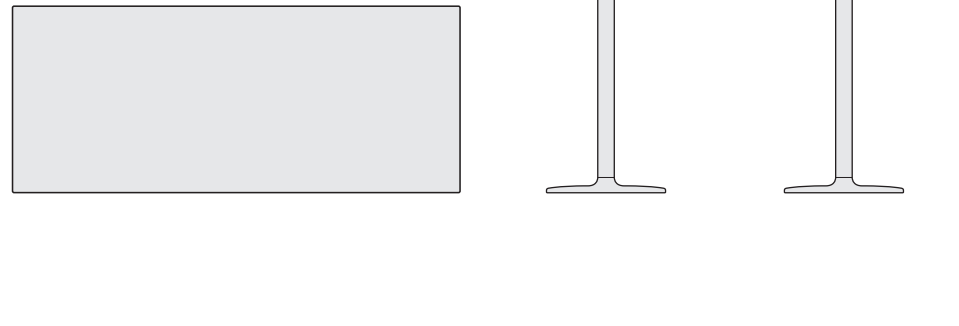
Counter/Bar Table True Rectangle Top Dual Base	Height options: 36", 42" Optional power through column Height adjustable glides Base ships flat packed or assembled	SERIES	STYLE	WIDTH	LENGTH	BASE DIA.	Laminate Top Edge/Finish				Wood Veneer Top Edge/Finish	
							STRAIGHT EDGE 1		REVERSE BEVEL 2		STRAIGHT EDGE 1	REVERSE BEVEL 2
							GRADE 1	GRADE 2	GRADE 1	GRADE 2	GRADE 1	GRADE 1
		OB	TR	30	56	18	2,943	4,176	3,797	4,577	4,057	4,484
					60	18	2,957	4,496	3,882	4,908	4,206	4,650
					72	18	3,120	4,909	4,167	5,361	4,657	5,161
					84	18	3,138	5,303	4,428	5,791	5,066	5,621
					96	18	3,252	5,694	4,687	6,224	5,437	6,046
					108	18	3,462	6,095	4,956	6,661	5,872	6,534
				36	56	18	3,089	4,391	4,006	4,828	4,354	4,830
					60	18	3,104	4,430	4,105	4,882	4,529	5,031
					72	18	3,283	4,976	4,399	5,474	5,021	5,587
					84	18	3,643	5,406	4,727	5,946	5,527	6,161
					96	24	4,121	6,254	5,469	6,840	6,406	7,102
					108	24	4,419	6,671	5,775	7,298	6,938	7,703

To Order Select Below

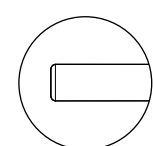
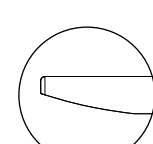
1. Series/Style	2. Top Size	3. Top Finish	4. Top Edge Detail	5. Power	6. Base Height	7. Glide	8. Base Set Up	9. Base Finish		
<p>OBTR</p> <p>Obair Table True Rectangle Top</p>	<p>Top Size</p> <p>30056 30W x 56L</p> <p>30060 30W x 60L</p> <p>30072 30W x 72L</p> <p>30084 30W x 84L</p> <p>30096 30W x 96L</p> <p>30108 30W x 108L</p> <p>36056 36W x 56L</p> <p>36060 36W x 60L</p> <p>36072 36W x 72L</p> <p>36084 36W x 84L</p> <p>36096 36W x 96L</p> <p>36108 36W x 108L</p>	<p>Laminate - Grade 1</p> <p>LM01 DESIGNER WHITE</p> <p>LM02 ALABASTER</p> <p>LM03 WALLABY</p> <p>LM05 DOVE GREY</p> <p>LM06 FASHION GREY</p> <p>LM04 SHADOW</p> <p>LM08 NORTH SEA</p> <p>LM07 SLATE GREY</p> <p>LM09 BLACK</p> <p>LM10 FUSION MAPLE</p> <p>LM11 MONTICELLO MAPLE</p> <p>LM12 RIVER CHERRY</p> <p>LM13 AMBER CHERRY</p> <p>LM14 WALNUT HEIGHTS</p> <p>LM15 MONTANA WALNUT</p> <p>LM16 XANADU</p> <p>LM17 ASIAN NIGHT</p>	<p>Laminate - Grade 2</p> <p>LM41 BIANCO KOS</p> <p>LM42 GRIGIO EFESO</p> <p>LM43 GRIGIO LONDRA</p> <p>LM44 GRIGIO BROMO</p> <p>LM45 NERO INGO</p> <p>Custom Finish</p> <p>LM99 CUSTOM LAMINATE</p> <p>WV99 CUSTOM WOOD</p> <p>See page 6 for custom laminate and custom wood details.</p>	<p>Wood Veneer - Grade 1</p> <p>WV05 TONED ASH</p> <p>WV06 NATURAL MAPLE</p> <p>WV49 NATURAL RECON WHITE OAK</p> <p>WV45 TONED RECON OAK</p> <p>WV44 TONED OAK</p> <p>WV48 NATURAL WHITE</p> <p>WV01 LIGHT GREY</p> <p>WV46 NATURAL FLAT CUT WALNUT</p> <p>WV47 NATURAL RIFT CUT WALNUT</p> <p>WV41 TONED RECON WALNUT</p> <p>WV04 MEDIUM CHERRY</p> <p>WV43 TONED WENGE</p> <p>WV02 WARM GREY</p> <p>WV42 DARK TONED OAK</p> <p>WV03 OPAQUE BLACK</p>	<p>Top Edge Detail</p> <p>ST1 STRAIGHT EDGE 1</p> <p>RB2 REVERSE BEVEL 2</p> <p> ST1</p> <p> RB2</p> <p>Grade 1 laminate edge has a 2mm PVC edge. Grade 2 laminate has a 1mm ABS edge. Wood edge has a 3mm wood veneer edge.</p>	<p>Power</p> <p>Please see page 7 for Obair Table power prices and model codes.</p>	<p>Base Height</p> <p>B36 36"</p> <p>B42 42"</p> <p>Base diameter is automatically assigned during order entry.</p>	<p>Glide</p> <p>PLASTIC, PG CARPET</p> <p>SOFT PLASTIC, SG FLOOR</p> <p>All glides are adjustable. Soft plastic glides are not designed for sliding tables.</p>	<p>Base Set Up</p> <p>F PACKED</p> <p>A ASSEMBLED +402</p>	<p>Standard Powder Coated Metal</p> <p>BL BLUE</p> <p>NK NICKEL</p> <p>BM BLACK MATTE</p> <p>NV NAVY</p> <p>BR BRASS</p> <p>OR ORANGE</p> <p>BT BLACK TWILIGHT</p> <p>PY PALE YELLOW</p> <p>CP CHAMPAGNE</p> <p>RD RED</p> <p>DB DARK BRONZE</p> <p>RO RED ORANGE</p> <p>DG DARK GRAY</p> <p>RR RUSTY RED</p> <p>DP DUSTY PINK</p> <p>SB SOFT BLUE</p> <p>FG FOREST GREEN</p> <p>SD SAND</p> <p>LG LIGHT GRAY</p> <p>TC TERRACOTTA</p> <p>MG MEADOW GREEN</p> <p>TP TAUPE</p> <p>MK MILK</p> <p>TS TEXTURED SLATE</p> <p>MS METALLIC SILVER</p> <p>YL YELLOW</p>

Obair Tables

COUNTER/BAR TABLE: TRUE RECTANGLE

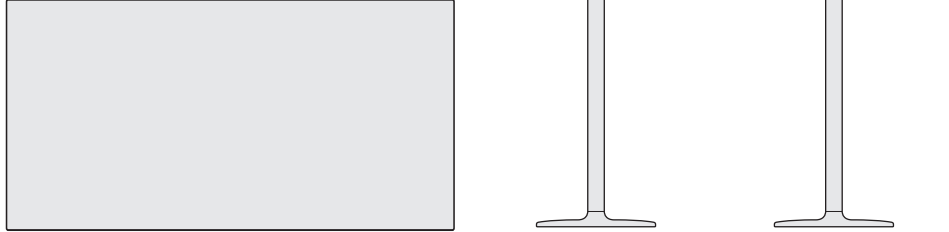
Counter/Bar Table True Rectangle Top Dual Base	Height options: 36", 42" Optional power through column Height adjustable glides Base ships flat packed or assembled	SERIES	STYLE	WIDTH	LENGTH	BASE DIA.	Laminate Top Edge/Finish				Wood Veneer Top Edge/Finish	
							STRAIGHT EDGE 1		REVERSE BEVEL 2		STRAIGHT EDGE 1	REVERSE BEVEL 2
							GRADE 1	GRADE 2	GRADE 1	GRADE 2	GRADE 1	GRADE 1
		OB	TR	42	56	24	3,571	4,914	4,659	5,381	5,120	5,650
					60	24	3,583	5,096	4,770	5,589	5,322	5,878
					72	24	3,758	5,534	5,133	6,079	5,911	6,546
					84	28	4,703	6,554	6,069	7,145	7,059	7,765
					96	28	4,742	7,255	6,405	7,896	7,554	8,337
					108	28	5,021	7,391	6,748	8,090	8,125	8,977
				48	84	28	4,716	6,651	6,367	7,299	7,494	8,330
					96	28	4,741	7,388	6,740	8,097	8,051	8,980
					108	28	5,036	7,535	7,120	8,305	8,692	9,716

To Order Select Below

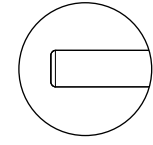
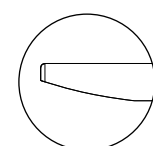
1. Series/Style	2. Top Size	3. Top Finish	4. Top Edge Detail	5. Power	6. Base Height	7. Glide	8. Base Set Up	9. Base Finish		
<p>OBTR</p> <p>Obair Table True Rectangle Top</p>	<p>Top Size</p> <p>42056 42W x 56L</p> <p>42060 42W x 60L</p> <p>42072 42W x 72L</p> <p>42084 42W x 84L</p> <p>42096 42W x 96L</p> <p>42108 42W x 108L</p> <p>48084 48W x 84L</p> <p>48096 48W x 96L</p> <p>48108 48W x 108L</p>	<p>Laminate - Grade 1</p> <p>LM01 DESIGNER WHITE</p> <p>LM02 ALABASTER</p> <p>LM03 WALLABY</p> <p>LM05 DOVE GREY</p> <p>LM06 FASHION GREY</p> <p>LM04 SHADOW</p> <p>LM08 NORTH SEA</p> <p>LM07 SLATE GREY</p> <p>LM09 BLACK</p> <p>LM10 FUSION MAPLE</p> <p>LM11 MONTICELLO MAPLE</p> <p>LM12 RIVER CHERRY</p> <p>LM13 AMBER CHERRY</p> <p>LM14 WALNUT HEIGHTS</p> <p>LM15 MONTANA WALNUT</p> <p>LM16 XANADU</p> <p>LM17 ASIAN NIGHT</p>	<p>Laminate - Grade 2</p> <p>LM41 BIANCO KOS</p> <p>LM42 GRIGIO EFESO</p> <p>LM43 GRIGIO LONDRA</p> <p>LM44 GRIGIO BROMO</p> <p>LM45 NERO INGO</p> <p>Custom Finish</p> <p>LM99 CUSTOM LAMINATE</p> <p>WV99 CUSTOM WOOD</p> <p>See page 6 for custom laminate and custom wood details.</p>	<p>Wood Veneer - Grade 1</p> <p>WV05 TONED ASH</p> <p>WV06 NATURAL MAPLE</p> <p>WV49 NATURAL RECON WHITE OAK</p> <p>WV45 TONED RECON OAK</p> <p>WV44 TONED OAK</p> <p>WV48 NATURAL WHITE</p> <p>WV01 LIGHT GREY</p> <p>WV46 NATURAL FLAT CUT WALNUT</p> <p>WV47 NATURAL RIFT CUT WALNUT</p> <p>WV41 TONED RECON WALNUT</p> <p>WV04 MEDIUM CHERRY</p> <p>WV43 TONED WENGE</p> <p>WV02 WARM GREY</p> <p>WV42 DARK TONED OAK</p> <p>WV03 OPAQUE BLACK</p>	<p>Top Edge Detail</p> <p>ST1 STRAIGHT EDGE 1</p> <p>RB2 REVERSE BEVEL 2</p> <p> ST1</p> <p> RB2</p> <p>Grade 1 laminate edge has a 2mm PVC edge. Grade 2 laminate has a 1mm ABS edge. Wood edge has a 3mm wood veneer edge.</p>	<p>Power</p> <p>Please see page 7 for Obair Table power prices and model codes.</p>	<p>Base Height</p> <p>B36 36"</p> <p>B42 42"</p> <p>Base diameter is automatically assigned during order entry.</p>	<p>Glide</p> <p>PLASTIC, PG CARPET</p> <p>SOFT PLASTIC, SG FLOOR</p> <p>All glides are adjustable. Soft plastic glides are not designed for sliding tables.</p>	<p>Base Set Up</p> <p>F PACKED</p> <p>A ASSEMBLED +402</p>	<p>Standard Powder Coated Metal</p> <p>BL BLUE</p> <p>NK NICKEL</p> <p>BM BLACK MATTE</p> <p>NV NAVY</p> <p>BR BRASS</p> <p>OR ORANGE</p> <p>BT BLACK TWILIGHT</p> <p>PY PALE YELLOW</p> <p>CP CHAMPAGNE</p> <p>RD RED</p> <p>DB DARK BRONZE</p> <p>RO RED ORANGE</p> <p>DG DARK GRAY</p> <p>RR RUSTY RED</p> <p>DP DUSTY PINK</p> <p>SB SOFT BLUE</p> <p>FG FOREST GREEN</p> <p>SD SAND</p> <p>LG LIGHT GRAY</p> <p>TC TERRACOTTA</p> <p>MG MEADOW GREEN</p> <p>TP TAUPE</p> <p>MK MILK</p> <p>TS TEXTURED SLATE</p> <p>MS METALLIC SILVER</p> <p>YL YELLOW</p>

Obair Tables

COUNTER/BAR TABLE: SOFT RECTANGLE

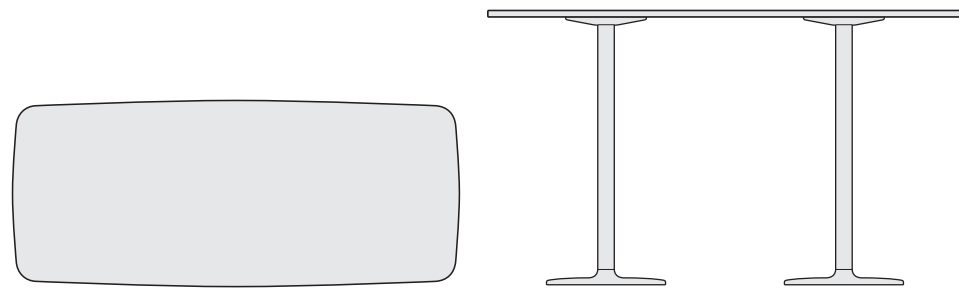
	SERIES	STYLE	WIDTH	LENGTH	BASE DIA.	Laminate Top Edge/Finish		Wood Veneer Top Edge/Finish			
						STRAIGHT EDGE 1	REVERSE BEVEL 2	STRAIGHT EDGE 1	REVERSE BEVEL 2		
Counter/Bar Table Soft Rectangle Top Dual Base Height options: 36", 42" Optional power through column Height adjustable glides Base ships flat packed or assembled 	OB	SR	30	56	18	2,973	4,098	3,782	4,561	4,108	4,534
				60	18	2,985	4,399	3,858	4,887	4,248	4,700
				72	18	3,148	4,800	4,140	5,340	4,718	5,213
				84	18	3,250	5,164	4,380	5,750	5,110	5,665
				96	18	3,279	5,525	4,616	6,163	5,473	6,046
				108	18	3,493	5,889	4,861	6,583	5,898	6,731
			36	56	18	3,117	4,294	3,968	4,798	4,396	4,874
				60	18	3,132	4,327	4,057	4,846	4,562	5,067
				72	18	3,312	4,790	4,284	5,376	5,004	5,568
				84	18	3,674	5,236	4,646	5,878	5,560	6,195
				96	24	4,153	6,053	5,359	6,752	6,431	7,075
				108	24	4,452	6,429	5,641	7,184	6,946	7,711

To Order Select Below

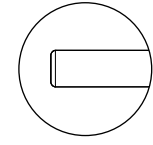
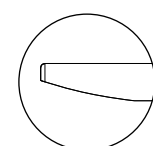





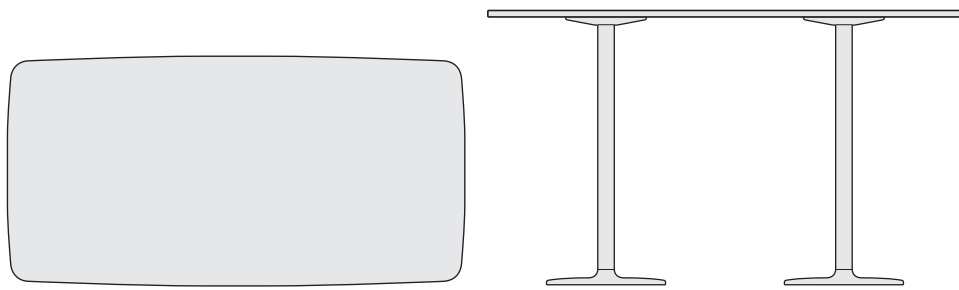

1. Series/Style	2. Top Size	3. Top Finish	4. Top Edge Detail	5. Power	6. Base Height	7. Glide	8. Base Set Up	9. Base Finish	
<p>Obair Table Soft Rectangle Top</p> <p>OBSR</p>	<p>Top Size</p> <p>30056 30W x 56L 30060 30W x 60L 30072 30W x 72L 30084 30W x 84L 30096 30W x 96L 30108 30W x 108L 36056 36W x 56L 36060 36W x 60L 36072 36W x 72L 36084 36W x 84L 36096 36W x 96L 36108 36W x 108L</p>	<p>Laminate - Grade 1</p> <p>LM01 DESIGNER WHITE LM02 ALABASTER LM03 WALLABY LM05 DOVE GREY LM06 FASHION GREY LM04 SHADOW LM08 NORTH SEA LM07 SLATE GREY LM09 BLACK LM10 FUSION MAPLE LM11 MONTICELLO MAPLE LM12 RIVER CHERRY LM13 AMBER CHERRY LM14 WALNUT HEIGHTS LM15 MONTANA WALNUT LM16 XANADU LM17 ASIAN NIGHT</p> <p>Laminate - Grade 2</p> <p>LM41 BIANCO KOS LM42 GRIGIO EFESO LM43 GRIGIO LONDRA LM44 GRIGIO BROMO LM45 NERO INGO</p> <p>Custom Finish</p> <p>LM99 CUSTOM LAMINATE WV99 CUSTOM WOOD</p> <p>See page 6 for custom laminate and custom wood details.</p>	<p>Wood Veneer - Grade 1</p> <p>WV05 TONED ASH WV06 NATURAL MAPLE WV49 NATURAL RECON WHITE OAK WV45 TONED RECON OAK WV44 TONED OAK WV48 NATURAL WHITE WV01 LIGHT GREY WV46 NATURAL FLAT CUT WALNUT WV47 NATURAL RIFT CUT WALNUT WV41 TONED RECON WALNUT WV04 MEDIUM CHERRY WV43 TONED WENGE WV02 WARM GREY WV42 DARK TONED OAK WV03 OPAQUE BLACK</p>	<p>Top Edge Detail</p> <p>ST1 STRAIGHT EDGE 1 RB2 REVERSE BEVEL 2</p> <p> ST1  RB2</p> <p>Grade 1 laminate edge has a 2mm PVC edge. Grade 2 laminate has a 1mm ABS edge. Wood edge has a 3mm wood veneer edge.</p>	<p>Power</p> <p>Please see page 7 for Obair Table power prices and model codes.</p>	<p>Base Height</p> <p>B36 36" B42 42"</p> <p>Base diameter is automatically assigned during order entry.</p>	<p>Glide</p> <p>PLASTIC, PG CARPET SOFT PLASTIC, SG FLOOR</p> <p>All glides are adjustable. Soft plastic glides are not designed for sliding tables.</p>	<p>Base Set Up</p> <p>F PACKED A ASSEMBLED +402</p>	<p>Standard Powder Coated Metal</p> <p>BL BLUE BM BLACK MATTE BR BRASS BT BLACK TWILIGHT CP CHAMPAGNE DB DARK BRONZE DG DARK GRAY DP DUSTY PINK FG FOREST GREEN LG LIGHT GRAY MG MEADOW GREEN MK MILK MS METALLIC SILVER NK NICKEL NV NAVY OR ORANGE PY PALE YELLOW RD RED RO RED ORANGE RR RUSTY RED SB SOFT BLUE SD SAND TC TERRACOTTA TP TAUPE TS TEXTURED SLATE YL YELLOW</p>

Obair Tables

COUNTER/BAR TABLE: SOFT RECTANGLE

Counter/Bar Table Soft Rectangle Top Dual Base	Height options: 36", 42" Optional power through column Height adjustable glides Base ships flat packed or assembled	SERIES	STYLE	WIDTH	LENGTH	BASE DIA.	Laminate Top Edge/Finish				Wood Veneer Top Edge/Finish	
							STRAIGHT EDGE 1		REVERSE BEVEL 2		STRAIGHT EDGE 1	REVERSE BEVEL 2
							GRADE 1	GRADE 2	GRADE 1	GRADE 2	GRADE 1	GRADE 1
		OB	SR	42	56	24	3,588	4,832	4,556	5,299	5,111	5,632
					60	24	3,601	5,003	4,701	5,532	5,348	5,904
					72	24	3,788	5,380	5,005	5,971	5,903	6,530
					84	28	4,734	6,358	5,909	7,016	7,035	7,739
					96	28	4,776	7,008	6,214	7,743	7,562	8,241
					108	28	5,062	7,119	6,570	7,941	8,116	8,977
				48	84	28	4,750	6,430	6,176	7,145	7,460	8,242
					96	28	4,776	7,111	6,559	7,943	7,989	8,911
					108	28	5,075	7,231	6,902	8,126	8,663	9,621

To Order Select Below

1. Series/Style	2. Top Size	3. Top Finish	4. Top Edge Detail	5. Power	6. Base Height	7. Glide	8. Base Set Up	9. Base Finish
								
OBSR	Top Size	Laminate - Grade 1	Top Edge Detail	Standard Powder Coated Metal				
	42056 42W x 56L	LM01 DESIGNER WHITE	ST1 STRAIGHT EDGE 1	BL BLUE				NK NICKEL
	42060 42W x 60L	LM02 ALABASTER	RB2 REVERSE BEVEL 2	BM BLACK MATTE				NV NAVY
Obair Table Soft Rectangle Top	42072 42W x 72L	LM03 WALLABY		BR BRASS				OR ORANGE
	42084 42W x 84L	LM05 DOVE GREY		BT BLACK TWILIGHT				PY PALE YELLOW
	42096 42W x 96L	LM06 FASHION GREY		CP CHAMPAGNE				RD RED
	42108 42W x 108L	LM04 SHADOW		DB DARK BRONZE				RO RED ORANGE
	48084 48W x 84L	LM08 NORTH SEA		DG DARK GRAY				RR RUSTY RED
	48096 48W x 96L	LM07 SLATE GREY		DP DUSTY PINK				SB SOFT BLUE
	48108 48W x 108L	LM09 BLACK		FG FOREST GREEN				SD SAND
		LM10 FUSION MAPLE		LG LIGHT GRAY				TC TERRACOTTA
		LM11 MONTICELLO MAPLE		MG MEADOW GREEN				TP TAUPE
		LM12 RIVER CHERRY		MK MILK				TS TEXTURED SLATE
		LM13 AMBER CHERRY		MS METALLIC SILVER				YL YELLOW
		LM14 WALNUT HEIGHTS						
		LM15 MONTANA WALNUT						
		LM16 XANADU						
		LM17 ASIAN NIGHT						
		Custom Finish						
		LM99 CUSTOM LAMINATE						
		WV99 CUSTOM WOOD						
		See page 6 for custom laminate and custom wood details.						
			ST1					
			RB2					
			Grade 1 laminate edge has a 2mm PVC edge. Grade 2 laminate has a 1mm ABS edge. Wood edge has a 3mm wood veneer edge.					
				Please see page 7 for Obair Table power prices and model codes.				
					Base Height			
					B36 36"			
					B42 42"			
					Base diameter is automatically assigned during order entry.			
						Glide		
						PLASTIC, PG CARPET		
						SOFT PLASTIC, SG FLOOR		
						All glides are adjustable. Soft plastic glides are not designed for sliding tables.		
							Base Set Up	
							FLAT PACKED	
							ASSEMBLED A +402	